



# *RX-V1065*

---

*AV Receiver*

OWNER'S MANUAL

## Caution: Read this before operating your unit.

- 1 To assure the finest performance, please read this manual carefully. Keep it in a safe place for future reference.
- 2 Install this sound system in a well ventilated, cool, dry, clean place – away from direct sunlight, heat sources, vibration, dust, moisture, and/or cold. Allow ventilation space of at least 30 cm on the top, 20 cm on the left and right, and 20 cm on the back of this unit.
- 3 Locate this unit away from other electrical appliances, motors, or transformers to avoid humming sounds.
- 4 Do not expose this unit to sudden temperature changes from cold to hot, and do not locate this unit in an environment with high humidity (i.e. a room with a humidifier) to prevent condensation inside this unit, which may cause an electrical shock, fire, damage to this unit, and/or personal injury.
- 5 Avoid installing this unit where foreign objects may fall onto this unit and/or this unit may be exposed to liquid dripping or splashing. On the top of this unit, do not place:
  - Other components, as they may cause damage and/or discoloration on the surface of this unit.
  - Burning objects (i.e. candles), as they may cause fire, damage to this unit, and/or personal injury.
  - Containers with liquid in them, as they may fall and liquid may cause electrical shock to the user and/or damage to this unit.
- 6 Do not cover this unit with a newspaper, tablecloth, curtain, etc. in order not to obstruct heat radiation. If the temperature inside this unit rises, it may cause fire, damage to this unit, and/or personal injury.
- 7 Do not plug in this unit to a wall outlet until all connections are complete.
- 8 Do not operate this unit upside-down. It may overheat, possibly causing damage.
- 9 Do not use force on switches, knobs and/or cords.
- 10 When disconnecting the power cable from the wall outlet, grasp the plug; do not pull the cable.
- 11 Do not clean this unit with chemical solvents; this might damage the finish. Use a clean, dry cloth.
- 12 Only voltage specified on this unit must be used. Using this unit with a higher voltage than specified is dangerous and may cause fire, damage to this unit, and/or personal injury. Yamaha will not be held responsible for any damage resulting from use of this unit with a voltage other than specified.
- 13 To prevent damage by lightning, keep the power cord and outdoor antennas disconnected from a wall outlet or the unit during a lightning storm.
- 14 Do not attempt to modify or fix this unit. Contact qualified Yamaha service personnel when any service is needed. The cabinet should never be opened for any reasons.
- 15 When not planning to use this unit for long periods of time (i.e. vacation), disconnect the AC power plug from the wall outlet.
- 16 Install this unit near the AC outlet and where the AC power plug can be reached easily.
- 17 Be sure to read the “Troubleshooting” section on common operating errors before concluding that this unit is faulty.
- 18 Before moving this unit, press **ⓀMAIN ZONE ON/OFF** to set this unit to the standby mode, and disconnect the AC power plug from the wall outlet in the main room.
- 19 **VOLTAGE SELECTOR** (Asia and General models only)  
The **VOLTAGE SELECTOR** on the rear panel of this unit must be set for your local main voltage **BEFORE** plugging into the AC wall outlet. Voltages are:
  - ..... AC 110/120/220/230-240 V, 50/60 Hz (General model)
  - .....AC 220/230-240 V, 50/60 Hz (Asia model)
- 20 The batteries shall not be exposed to excessive heat such as sunshine, fire or like.
- 21 Excessive sound pressure from earphones and headphones can cause hearing loss.
- 22 When replacing the batteries, be sure to use batteries of the same type. Danger of explosion may happen if batteries are incorrectly replaced.

### WARNING

TO REDUCE THE RISK OF FIRE OR ELECTRIC SHOCK, DO NOT EXPOSE THIS UNIT TO RAIN OR MOISTURE.

As long as this unit is connected to the AC wall outlet, it is not disconnected from the AC power source even if you turn off this unit by **ⓀMAIN ZONE ON/OFF**. In this state, this unit is designed to consume a very small quantity of power.

# Contents

## INTRODUCTION

<b>Features</b> .....	2
<b>About this manual</b> .....	3
<b>Supplied accessories</b> .....	3
<b>Part names and functions</b> .....	4
Front panel.....	4
Rear panel.....	5
Front panel display.....	6
Remote control.....	7
<b>Quick start guide</b> .....	8

## PREPARATION

<b>Preparing remote control</b> .....	9
Installing batteries in the remote control.....	9
Using the remote control.....	9
<b>Connections</b> .....	10
Placing speakers.....	10
Connecting speakers.....	11
Information on jacks and cable plugs.....	13
Connecting a TV monitor or projector.....	14
Connecting other components.....	15
Connecting a Yamaha iPod universal dock or Bluetooth™ wireless audio receiver.....	17
Connecting a USB storage device.....	18
Using the VIDEO AUX jacks.....	18
Connecting the FM and AM antennas.....	18
Connecting the power cable.....	19
Turning this unit on and off.....	19
<b>Optimizing the speaker setting for your listening room (YPAO)</b> .....	20
Using Auto Setup.....	20
When an error message is displayed during measurement.....	22
When a warning message is displayed after measurement.....	22

## BASIC OPERATION

<b>Playback</b> .....	23
Basic procedure.....	23
Using the SCENE function.....	23
Selecting a source on the GUI screen.....	24
Muting audio output.....	24
Adjusting high/low frequency sounds (tone control).....	24
Enjoying pure hi-fi sound.....	24
Using your headphones.....	25
Displaying input signal information.....	25
Changing information on the front panel display.....	25
<b>Enjoying the sound field programs</b> .....	26
Selecting sound field programs.....	26
Enjoying unprocessed input sources (Straight decode mode).....	29
Enjoying sound field programs without surround speakers (Virtual CINEMA DSP).....	29
Enjoy sound field programs with headphones (SILENT CINEMA™).....	29
Using CINEMA DSP 3D mode.....	29
<b>FM/AM tuning</b> .....	30
Tuning in to the desired FM/AM station (Frequency tuning).....	30
Registering FM/AM stations and tuning in (Preset tuning).....	30
<b>Using iPod™</b> .....	32
Controlling iPod™.....	32
<b>Using Bluetooth™ components</b> .....	34
Pairing the Bluetooth™ wireless audio receiver and your Bluetooth component.....	34
Playback of the Bluetooth™ component.....	34
<b>Using USB storage devices</b> .....	35
Playback of the USB storage device.....	35

<b>Other functions</b> .....	36
Using the sleep timer.....	36
Using the HDMI™ control function.....	36

## ADVANCED OPERATION

<b>Setting the option menu for each input source (Option menu)</b> .....	37
Option menu items.....	37
Selecting a video signal to be output during an audio reproduction.....	39
<b>Editing surround decoders/sound field programs</b> .....	40
Setting sound field parameters.....	40
Sound field parameters.....	40
<b>Operating various settings for this unit (Setup menu)</b> .....	44
Basic operation of the Setup menu.....	45
Speaker Setup.....	45
Sound Setup.....	47
Function Setup.....	48
DSP Parameter.....	50
Memory Guard.....	50
<b>Using multi-zone configuration</b> .....	51
Connecting Zone2.....	51
Controlling Zone2.....	52
<b>Controlling other components with the remote control</b> .....	53
Setting remote control codes.....	53
Resetting all remote control codes.....	53
<b>Advanced setup</b> .....	54

## APPENDIX

<b>Troubleshooting</b> .....	56
<b>Glossary</b> .....	64
<b>Sound field program information</b> .....	66
<b>Information on HDMI™</b> .....	67
<b>Specifications</b> .....	68
<b>Index</b> .....	69

(at the end of this manual)

<b>Information about software</b> .....	i
<b>List of remote control codes</b> .....	ii

# INTRODUCTION

## Features

### ■ Built-in 7-channel power amplifier

- Minimum RMS Output Power (20 Hz to 20 kHz, 0.08% THD, 8 Ω)
- FRONT L/R: 105 W + 105 W
- CENTER: 105 W
- SURROUND L/R: 105 W + 105 W
- SURROUND BACK L/R: 105 W + 105 W

### ■ Speaker/Preout outputs

- Speaker terminals (7-channel), extra speaker terminals (2-channel for presence or Zone2), preout jacks (7.1-channel)

### ■ Input/Output terminals

#### Input terminals

- HDMI input x 4
- Audio/Visual input
  - [Audio] Digital input (coaxial) x 2, digital input (optical) x 2, analog input x 2
  - [Video] Component video x 2, Video x 4
- Audio input (analog) x 2
- Phono input (analog) x 1
- Multi-channel audio input (7.1-channel)
- V-AUX input
  - [Audio] Analog x 1
  - [Video] Video x 1
- DOCK terminal to connect a Yamaha iPod universal dock (such as YDS-11, sold separately) or Bluetooth wireless audio receiver (such as YBA-10, sold separately)
- USB port to connect a USB storage device

#### Output terminals

- Monitor output
  - [Audio/Video] HDMI x 1
  - [Video] Component video x 1, Video x 1
- Audio/Visual output
  - [Audio] Analog x 1
  - [Video] Video x 1
- Audio output
  - Analog x 1
- Zone2 output
  - Analog x 1

#### Other terminals

- Remote input x 1, Remote output x 1
- Trigger output x 1

### ■ Proprietary Yamaha technology for the creation of sound fields

- CINEMA DSP 3D
- Compressed Music Enhancer mode
- Virtual CINEMA DSP
- SILENT CINEMA

### ■ Digital audio decoders

- Dolby TrueHD, Dolby Digital Plus decoder
- DTS-HD Master Audio, DTS-HD High Resolution Audio, DTS Express
- Dolby Digital/Dolby Digital EX decoder
- DTS, DTS 96/24 decoder, DTS-ES Matrix 6.1, DTS-ES Discrete 6.1
- Dolby Pro Logic/Dolby Pro Logic II/Dolby Pro Logic IIx decoder
- DSD decoder
- DTS NEO:6 decoder

### ■ HDMI™ (High-Definition Multimedia Interface)

- HDMI interface for standard, enhanced or high-definition video as well as multi-channel digital audio.
  - Automatic audio and video synchronization (lip sync) information capability
  - Deep Color video signal (30/36 bit) transmission capability
  - “x.v.Color” video signal transmission capability
  - High refresh rate and high resolution video signals capability
  - High definition digital audio format signals capability
- Analog to analog and HDMI digital video up-conversion (video ↔ component video → HDMI) capability for monitor out
- Analog video input up-scaling for HDMI digital video output 480i(576i) or 480p(576p) → 720p, 1080i or 1080p
- HDMI control function supported





### ■ Automatic speaker setup features

- “YPAO” (Yamaha Parametric Room Acoustic Optimizer) for automatically optimizing speaker outputs suitable for listening environments.

### ■ Other features

- 192-kHz/24-bit D/A converter
- GUI (graphic user interface) menus to optimize this unit to suit individual audiovisual system
- FM/AM tuning capability
- iPod and USB file browsing and album art display capability
- Pure Direct mode for pure hi-fi sound for all sources
- Adaptive dynamic range controlling capability
- SCENE function for changing input sources and sound field programs with one key
- Bi-amplification connection capability
- Sleep timer
- Multi-zone function

# About this manual

- Some operations can be performed by using either the keys on the front panel or the ones on the remote control. In case the key names differ between the front panel and the remote control, the key name on the remote control is given in parentheses.
- This manual is printed prior to production. Design and specifications are subject to change in part as a result of improvements, etc. In case of differences between the manual and product, the product has priority.
- For better viewing, we increase the size of characters used in example screen images in this manual. Therefore the size ratio of characters to other objects (such as icons) may be different from that of the actual display image.
- “ **MAIN ZONE ON/OFF**” or “ **HDMI 1**” (example) indicates the name of the parts on the front panel or the remote control. Refer to the attached sheet or “Part names and functions” (page 4).for the information about each position of the parts.
-  indicates the page describing the related information.
-  indicates a tip for your operation.



Manufactured under license from Dolby Laboratories.  
Dolby, Pro Logic and the double-D symbol are trademarks of Dolby Laboratories



Manufactured under license under U.S. Patent No's:  
5,451,942;5,956,674;5,974,380;5,978,762;6,226,616;6,487,535 &  
other U.S. and worldwide patents issued & pending. DTS is a  
registered trademark and the DTS logos, Symbol, DTS-HD and DTS-  
HD Master Audio are trademark of DTS, Inc. © 1996-2007 DTS, Inc.  
All Rights Reserved.

## iPod™

“iPod” is a trademark of Apple Inc., registered in the U.S. and other countries.

## Bluetooth™

Bluetooth is a registered trademark of Bluetooth SIG and is used by Yamaha in accordance with a license agreement.



“HDMI”, the “HDMI” logo and “High-Definition Multimedia Interface” are trademarks, or registered trademarks of HDMI Licensing LLC.

## x.v.Color

“x.v.Color” is a trademark of Sony Corporation.



“SILENT CINEMA” is a trademark of Yamaha Corporation.

# Supplied accessories

Check that you received all of the following parts.

- Remote control (page 7)
- Batteries (2) (AAA, R03, UM-4) (page 9)
- Optimizer microphone (page 20)
- AM loop antenna (page 18)
- Indoor FM antenna (page 18)

# Part names and functions

## Front panel

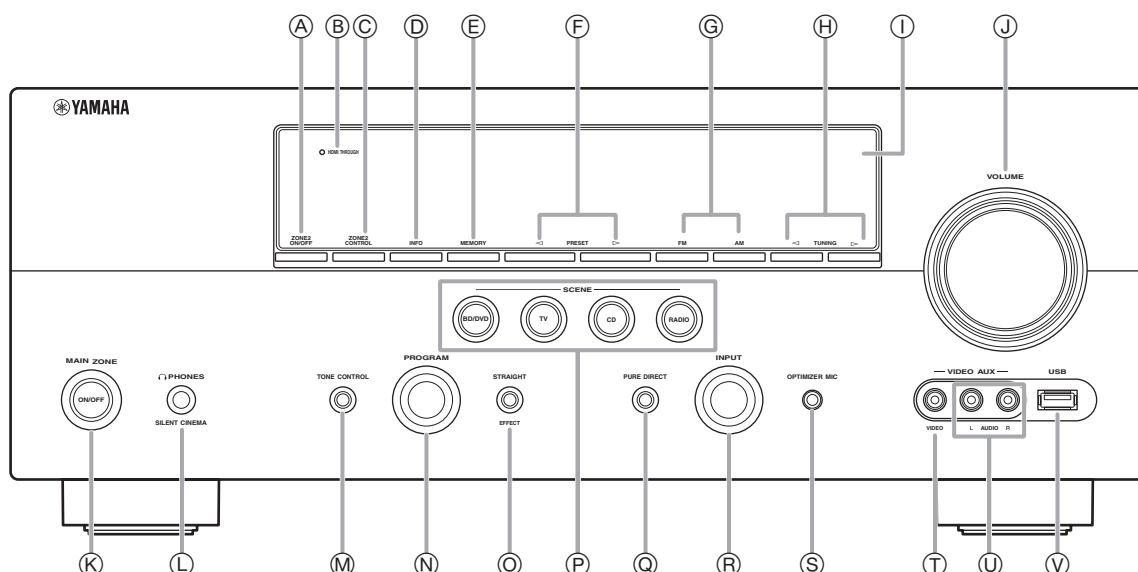

- A ZONE2 ON/OFF**  
Switches the zone function on and off (page 52).
- B HDMI THROUGH**  
Lights up in the following cases while this unit is on standby.
  - when the HDMI control function is on
  - when the HDMI signal standby-through function is currently working
- C ZONE2 CONTROL**  
Enables operation of a receiver set in Zone2, including input source switching, volume control and tuner operation, with the main amplifier or remote control after this key is pressed (page 52).
- D INFO**  
Changes information (input, DSP program, audio decoder, etc) displayed on the front panel display (page 25).
- E MEMORY**  
Registers FM/AM stations as preset stations (page 31).
- F PRESET** ◀ / ▶  
Selects an FM/AM preset station (page 31).
- G FM/AM**  
Change the tuner bands between FM and AM.
- H TUNING** ◀ / ▶  
Changes FM/AM frequencies.
- I Front panel display**  
Displays information on this unit (page 6).
- J VOLUME control**  
Controls the volume of this unit (page 23).
- K MAIN ZONE ON/OFF**  
Turns this unit on and off (page 19).
- L PHONES jack**  
For plugging headphones (page 25).
- M TONE CONTROL**  
Adjusts high-frequency/low-frequency output of speakers (page 24).
- N PROGRAM selector**  
Changes sound field programs (page 26).
- O STRAIGHT**  
Toggles between the selected sound field program and straight decode mode (page 29).
- P SCENE**  
Switches between linked sets of input sources and sound field programs (page 23).
- Q PURE DIRECT**  
Changes mode to Pure Direct mode (page 24). This key lights up when Pure Direct mode is on.
- R INPUT selector**  
Selects an input source (page 23).
- S OPTIMIZER MIC jack**  
For connecting the supplied optimizer microphone and adjusting output characteristics of speakers (page 20).
- T VIDEO (VIDEO AUX) jack**  
For connecting the video output cable of a camcorder or game console (page 18).
- U AUDIO L/R (VIDEO AUX) jack**  
For connecting the audio output cable of a camcorder or game console (page 18).
- V USB port**  
For connecting a USB memory device or USB portable audio player (page 18).

## Rear panel

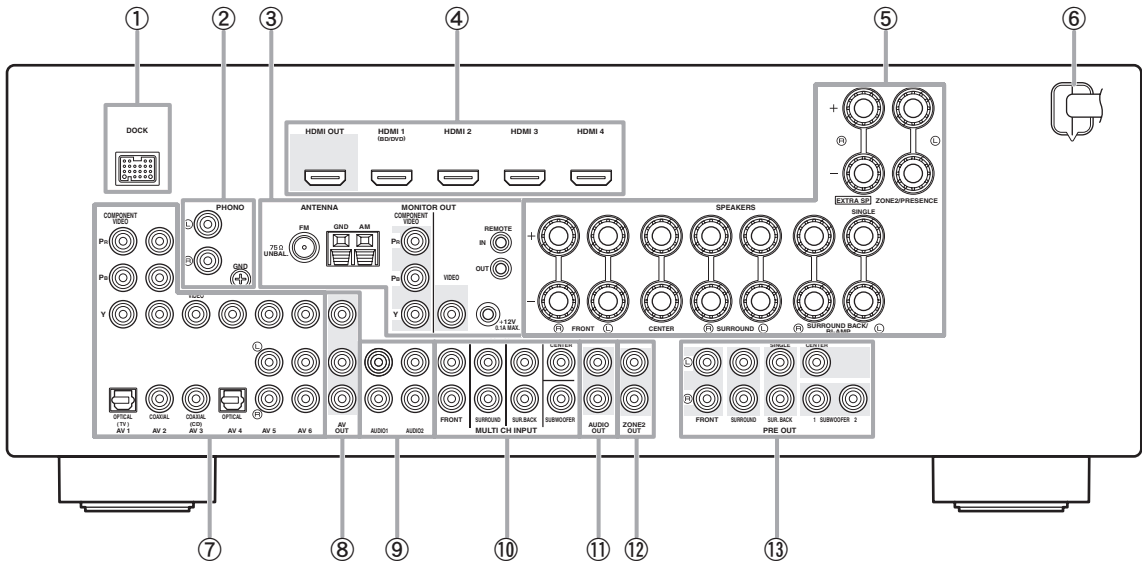

- ① **DOCK terminal**  
For connecting an optional Yamaha iPod universal dock (YDS-11) or Bluetooth wireless audio receiver (YBA-10) (page 17).
- ② **PHONO jacks**  
For connecting a turntable (page 15).
- ③ **ANTENNA terminals**  
For connecting supplied FM and AM antennas (page 18).
- MONITOR OUT jacks**  
Outputs visual signals from this unit to a video monitor, such as a TV (page 14).
- REMOTE IN/OUT jacks**  
For connecting an external component that supports the remote control function (page 17).
- TRIGGER OUT jack**  
For connecting an external terminal with a trigger input terminal to operate it linked with operation of this unit. For example, when an electric screen that supports a trigger input is connected, it opens and closes linked with operation of an input source selected in this unit.
- ④ **HDMI OUT/HDMI 1-4 jacks**  
For connecting an HDMI-compatible video monitor or external components for HDMI inputs 1-4 (pages 14 and 15).
- ⑤ **SPEAKERS terminals**  
For connecting front, center, surround and surround back speakers (page 11). Connect the presence speakers (page 11) or the speakers for Zone2 (page 51) to EXTRA SP terminals.
- ⑥ **Power cable**  
Connect this cable to an AC wall outlet (page 19).
- ⑦ **AV 1-6 jacks**  
For connecting external components for audio/visual inputs 1-6 (page 15).
- ⑧ **AV OUT jacks**  
Outputs audio/visual signals from a selected analog input source to an external component (page 15).
- ⑨ **AUDIO 1/2 jacks**  
For connecting external components for audio inputs 1-2 (page 15).
- ⑩ **MULTI CH INPUT jacks**  
For connecting a player that supports a multi-channel output (page 16).
- ⑪ **AUDIO OUT jacks**  
Outputs audio signals from a selected analog input source to an external component (page 15).
- ⑫ **ZONE2 OUT jacks**  
Outputs sound of this unit to an external amplifier set in a different zone (page 51).
- ⑬ **PRE OUT jacks**  
Outputs multi-channel signals from up to 7.1 channels to an external amplifier (page 17).

## Front panel display

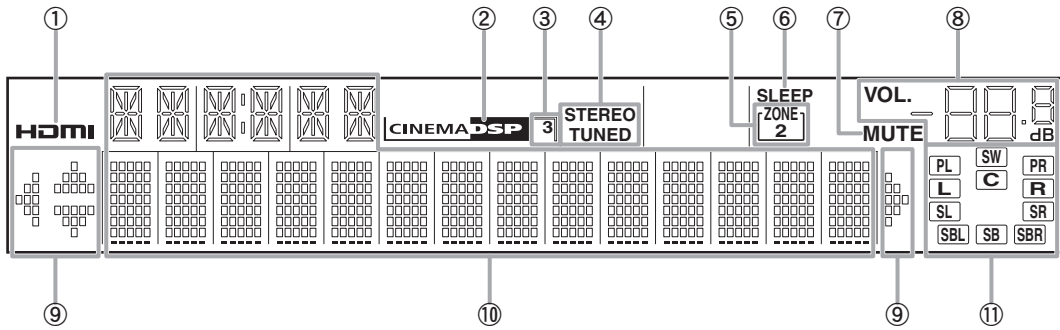

**① HDMI indicator**

Lights up during normal communication when HDMI is selected as an input source.

**② CINEMA DSP indicator**

Lights up when a sound field program that uses CINEMA DSP is selected.

**③ CINEMA DSP 3D indicator**

Lights up when CINEMA DSP 3D is activated.

**④ Tuner indicator**

Lights up during receiving radio broadcast signals from an FM/AM station (page 30).

**⑤ ZONE2 indicator**

Lights up when Zone2 is turned on.

**⑥ SLEEP indicator**

Lights up when the sleep timer is activated (page 36).

**⑦ MUTE indicator**

Flashes when audio is muted.

**⑧ VOLUME indicator**

Displays volume levels.

**⑨ Cursor indicators**

Light up if corresponding cursors on the remote control are available for operations.

**⑩ Multi information display**

Displays menu items and settings for the current operation.

**⑪ Speaker indicators**

Indicate speaker terminals from which signals are currently output.

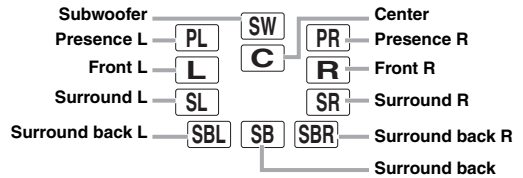



## Remote control

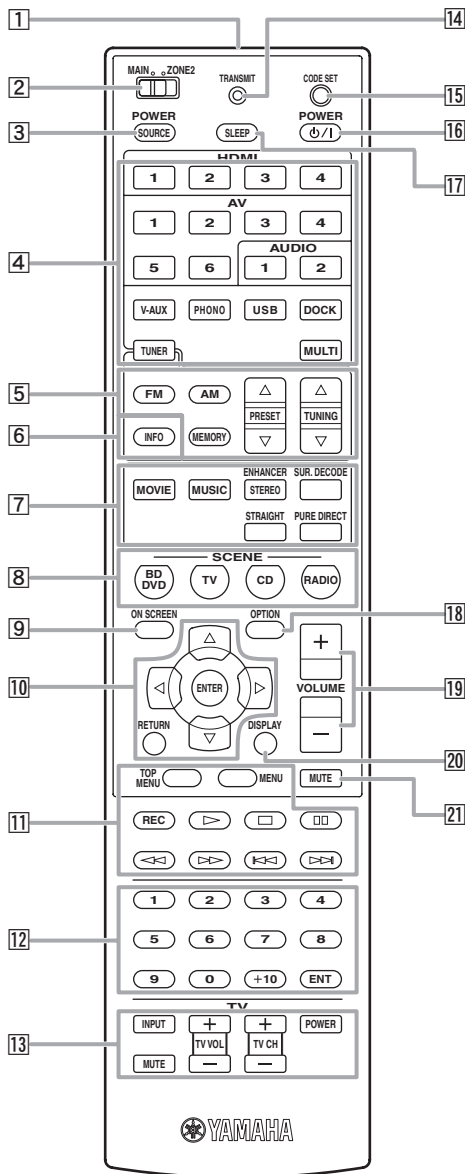

- 1 Remote control signal transmitter**  
Transmits infrared signals.
- 2 MAIN/ZONE2**  
Switches amplifiers (Main or Zone2) to be operated by the remote control (page 52).
- 3 SOURCE POWER**  
Switches an external component on and off.

- 4 Input selection keys**
- HDMI 1-4** Selects HDMI inputs 1 through 4.
- AV 1-6** Selects AV inputs 1 through 6.
- AUDIO 1/2** Selects AUDIO inputs 1 and 2.
- V-AUX** Selects a signal input from the VIDEO AUX jacks.
- PHONO** Selects a signal input from the PHONO jacks.
- USB** Selects a USB device connected to the USB port.
- DOCK** Selects a Yamaha iPod universal dock/Bluetooth wireless audio receiver connected to the DOCK terminal.
- TUNER** Selects the FM/AM tuner.
- MULTI** Selects a signal input from the MULTI CH INPUT jacks.
- 5 Tuner keys**
- FM/AM** Switches a band between FM and AM.
- MEMORY** Presets radio stations.
- PRESET  $\Delta / \nabla$**  Selects a preset station.
- TUNING  $\Delta / \nabla$**  Changes FM/AM frequencies.
- 6 INFO**  
Changes the information shown on the front panel display (page 25).
- 7 Sound selection keys**  
Selects sound field programs (page 26).
- 8 SCENE**  
Switches between linked sets of input sources and sound field programs (page 23).
- 9 ON SCREEN**  
Displays the GUI screen (page 24).
- 10 Cursors  $\Delta / \nabla / \triangleleft / \triangleright$**  Select menu items or change settings.
- ENTER** Confirms a selected item.
- RETURN** Returns to the previous screen or ends the menu display.
- 11 External component operation keys**  
Operate recording, playback etc. of external components (page 53).
- 12 Numeric keys**  
Enter numbers.
- 13 TV control keys**  
Enables operations of a TV or a projector (page 53).
- 14 TRANSMIT**  
Lights up when a signal is output from the remote control.
- 15 CODE SET**  
Sets remote control codes for external component operations (page 53).
- 16 POWER**  
Switches this unit on and standby (page 19).
- 17 SLEEP**  
Switches the sleep timer operations (page 36).
- 18 OPTION**  
Displays the Option menu (page 37).
- 19 VOLUME +/-**  
Adjust the volume of this unit (page 23).
- 20 DISPLAY**  
Displays the play information on the video monitor. When an iPod is connected: Changes the operation mode of the iPod connected to the Yamaha iPod universal dock (page 32).
- 21 MUTE**  
Turns the mute function on and off (page 24).

# Quick start guide

When you use this product for the first time, perform setup following the steps below. See the related pages for details on operations and settings.

## Step 1: Prepare items for setup

Prepare speakers, DVD player, cables, and other items necessary for setup.

For example, prepare the following items for setting up a 7.1-channel sound system.

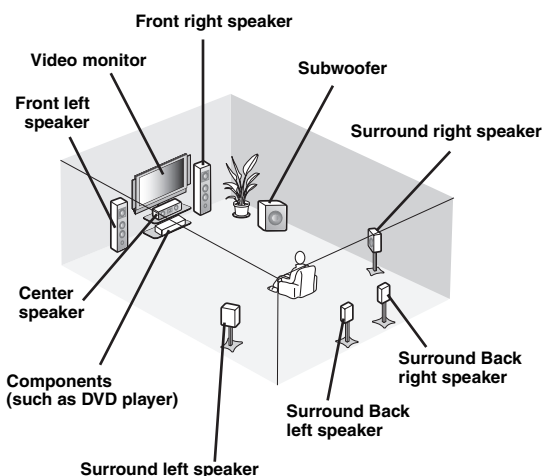

	Requirements	qty.
<b>Speakers</b>	Front speaker	2
	Center speaker	1
	Surround speaker	2
	Surround back speaker	2
<b>Active subwoofer</b>		1
<b>Speaker cable</b>		7
<b>Subwoofer cable</b>		1
<b>Reproduction component such as DVD player</b>		1
<b>Video monitor such as TV</b>		1
<b>Video cable or HDMI cable</b>		2
<b>Audio cable</b>		2



- Prepare two magnetically shielded speakers (for front). The priority of the requirement of other speakers is as follows:  
1 Two surround speakers  
2 One center speaker  
3 One (or two) surround back speaker(s)
- If your video monitor is a CRT, we recommend that you use magnetically shielded speakers.
- Video and audio cables are unnecessary if you use HDMI cables.

## Step 2: Set up your speakers

Place your speakers in the room and connect them to this unit.

- Placing speakers P. 10
- Connecting speakers P. 11



- This unit has a YPAO (Yamaha Parametric Room Acoustic Optimizer) that automatically optimizes this unit based on room acoustic characteristics (audio characteristics of the speakers, speaker positions, and room acoustics, etc.). You can enjoy good balanced sound without special knowledge by using the YPAO technology (P. 20).

## Step 3: Connect your components

Connect your TV, DVD player, or other components.

- Connecting a TV monitor or projector P. 14
- Connecting other components P. 15
- Connecting a multi-format player or an external decoder P. 16
- Connecting an external amplifier P. 17
- Connecting a USB storage device P. 18
- Connecting a Yamaha iPod universal dock or Bluetooth wireless audio receiver P. 17
- Connecting the FM and AM antennas P. 18

## Step 4: Turn on the power

Connect the power cable and turn on this unit.

- Connecting the power cable P. 19
- Turning this unit on and off P. 19

## Step 5: Select the input source and start playback

Select the component connected in step 3 as an input source and start playback.

- Basic procedure P. 23
- Selecting sound field programs P. 26



- This unit supports the SCENE function (page 23) that changes the input source and sound field program at one time. Four scenes are preset for different purposes for Blu-ray disc, DVD and CD, and you can select from a scene from those just by pressing a remote control key.

# PREPARATION

## Preparing remote control

### Installing batteries in the remote control

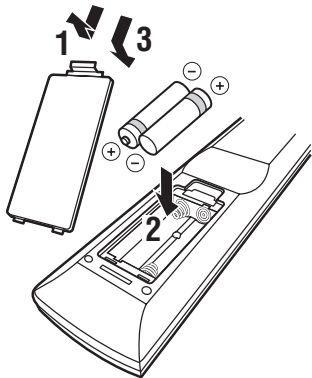

- 1 Take off the battery compartment cover.
- 2 Insert the two supplied batteries (AAA, R03, UM-4) according to the polarity markings (+ and -) on the inside of the battery compartment.
- 3 Snap the battery compartment cover back into place.

#### Notes

- Change all batteries if you notice the following conditions:
  - the operation range of the remote control narrows
  - the transmit indicator does not flash or is dim
- Do not use old batteries together with new ones.  
This may shorten the life of the new batteries or cause old batteries to leak.
- Do not use different types of batteries (such as alkaline and manganese batteries) together. Specification of batteries may be different even though they look the same.
- If you find leaking batteries, discard the batteries immediately, taking care not to touch the leaked material. If the leaked material comes into contact with your skin or gets into your eyes or mouth, rinse it away immediately and consult a doctor. Clean the battery compartment thoroughly before installing new batteries.
- Dispose of the old batteries correctly in accordance with your local regulations.
- If the remote control is without batteries for more than 2 minutes, or if exhausted batteries remain in the remote control, the contents of the memory may be cleared. In such a case, install new batteries and set the remote control code.

### Using the remote control

The remote control transmits a directional infrared ray. Be sure to aim the remote control directly at the remote control sensor on this unit during operation.

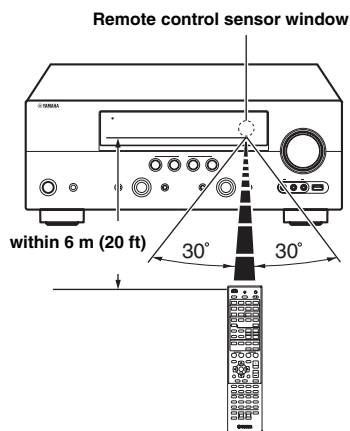

#### Notes

- Do not spill water or other liquids on the remote control.
- Do not drop the remote control.
- Do not leave or store the remote control in the following conditions:
  - places of high humidity, such as near a bath
  - places of high temperatures, such as near a heater or stove
  - places of extremely low temperatures
  - dusty places
- ☀️ You can operate external components with this remote control by setting the remote control code (page 53).

## Placing speakers

This unit supports up to 7.1-channel surround. We recommend the following speaker layout in order to obtain the optimum surround effect.

### 7.1-channel speaker layout

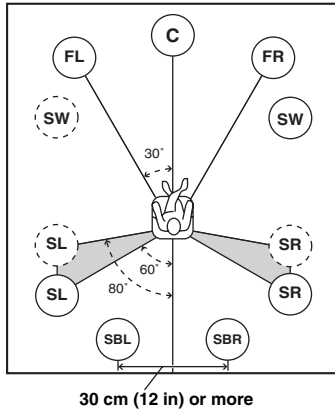

### 6.1-channel speaker layout

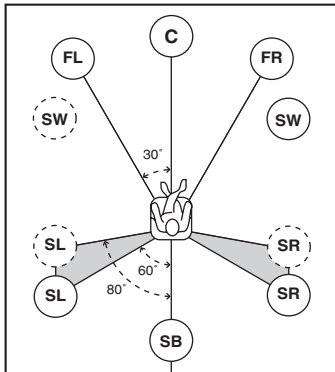

### 5.1-channel speaker layout

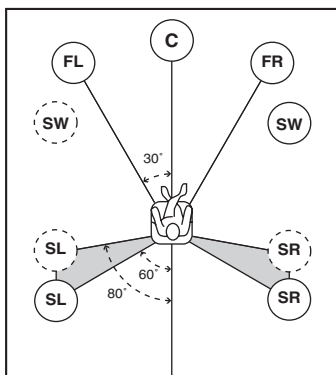

### Speaker channels

#### ■ Front left and right speakers (FL and FR)

The front speakers are used for the front channel sounds (stereo sound) and effect sounds. Place these speakers at an equal distance from the ideal listening position. When using a screen, the appropriate top positions of the speakers are about 1/4 of the screen from the bottom.

#### ■ Center speaker (C)

The center speaker is for the center channel sounds (dialog, vocals, etc.). Place it halfway between the left and right speakers. When using a TV, place the speaker just above or just under the center of the TV with the front surfaces of the TV and the speaker aligned. When using a screen, place it just under the center of the screen.

#### ■ Surround left and right speakers (SL and SR)

The surround speakers are used for effect and surround sounds. Place them at the rear left and rear right facing the listening position. To obtain a natural sound flow in the 5.1-channel speaker layout, place them slightly further back than in the 7.1-channel speaker layout.

#### ■ Surround back left and right speakers (SBL and SBR) / Surround back speaker (SB)

The surround back left and right speakers are used for rear effect sounds. Place them at the rear of the room facing the listening position at least 30 cm (1 ft) away from each other, ideally at the same distance as that between the front left and right speakers.

In the 6.1-channel speaker layout, surround back left and right channel sound signals are mixed down and output from the single surround back speaker.

In the 5.1-channel speaker layout, surround back left and right channel sound signals are output from the surround left and right speakers.

#### ■ Subwoofer (SW)

The subwoofer speaker is used for bass sounds and low-frequency effect (LFE) sounds included in Dolby Digital and DTS signals. Use a subwoofer with a built-in amplifier, such as the Yamaha Active Servo Processing Subwoofer System. Place it exterior to the front left and right speakers facing slightly inward to reduce reflections from a wall.

**■ Presence left and right speakers (PL and PR)**

The presence speakers supplement the sound from the front speakers with extra ambient effects produced by the sound field programs (page 26). We recommend that you use the presence speakers especially for the CINEMA DSP sound field programs. To use the presence speakers, connect the speakers to EXTRA SP terminals and then set “Extra Speaker Assignment” to “Presence” (page 46).

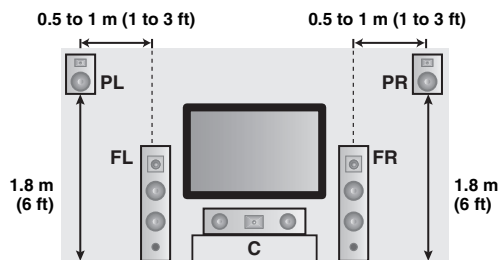

**Connecting speakers**

Connect your speakers to the respective terminals as follows, according to your speaker layout.



- Connect optional presence speakers or Zone2 speakers (page 51) to the EXTRA SP terminals.
- You can connect up to two subwoofers. When two subwoofers are connected, the same sound is output from them.

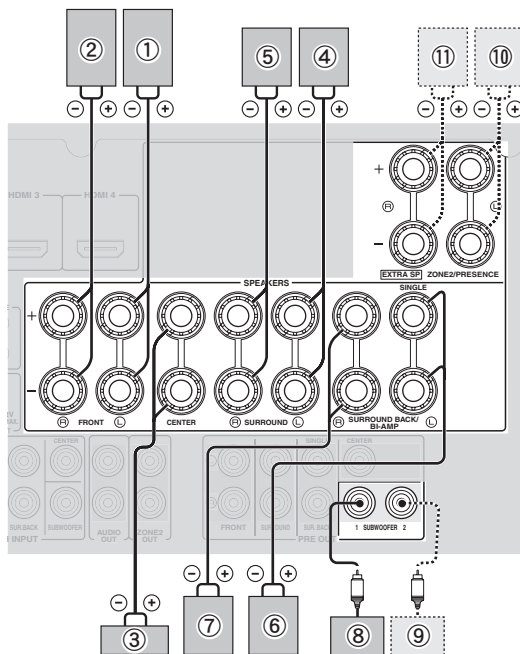

**■ 7.1-channel (with presence speakers)**

Speakers	Jacks on this unit
① Front speaker L	FRONT (L)
② Front speaker R	FRONT (R)
③ Center speaker	CENTER
④ Surround speaker L	SURROUND (L)
⑤ Surround speaker R	SURROUND (R)
⑥ Surround back speaker L	SURROUND BACK/BI-AMP (L)
⑦ Surround back speaker R	SURROUND BACK/BI-AMP (R)
⑧ Subwoofer 1	SUBWOOFER 1
⑨ Subwoofer 2 (optional)	SUBWOOFER 2
⑩ Presence speaker L (optional)	EXTRA SP (L)
⑪ Presence speaker R (optional)	EXTRA SP (R)

**■ 6.1-channel (with Zone2 speakers)**

Speakers	Jacks on this unit
① Front speaker L	FRONT (L)
② Front speaker R	FRONT (R)
③ Center speaker	CENTER
④ Surround speaker L	SURROUND (L)
⑤ Surround speaker R	SURROUND (R)
⑥ Surround back speaker	SURROUND BACK/BI-AMP (SINGLE)
⑧ Subwoofer 1	SUBWOOFER 1
⑨ Subwoofer 2 (optional)	SUBWOOFER 2
⑩ Zone2 speaker L (optional)	EXTRA SP (L)
⑪ Zone2 speaker R (optional)	EXTRA SP (R)

**■ 5.1-channel (with Zone2 speakers)**

Speakers	Jacks on this unit
① Front speaker L	FRONT (L)
② Front speaker R	FRONT (R)
③ Center speaker	CENTER
④ Surround speaker L	SURROUND (L)
⑤ Surround speaker R	SURROUND (R)
⑧ Subwoofer 1	SUBWOOFER 1
⑨ Subwoofer 2 (optional)	SUBWOOFER 2
⑩ Zone2 speaker L (optional)	EXTRA SP (L)
⑪ Zone2 speaker R (optional)	EXTRA SP (R)

**Caution**

- A speaker cable is a pair of insulated cables running side by side in general. One of the cables is colored differently or striped to indicate a polarity. Connect one end of the colored/striped cable to the “+” (red) terminal of this unit and the other end to that of your speaker, and connect one end of the other cable to the “-” (black) terminal of this unit and the other end to that of your speaker.
- Before connecting the speakers, be sure to disconnect the power cable.
- Do not let the bare speaker wires touch each other or any metal part of this unit. This could damage this unit and/or speakers. If the circuit shorts out, “CHECK SP WIRES!” appears on the front panel display when this unit is turned on.
- If images on the monitor (CRT) are distorted, place the speakers away from the video monitor. If it does not work, use magnetically shielded speakers.
- Use speakers with an impedance of 6-ohm or larger. Set speaker impedance in the advanced setup menu before connecting the speakers (page 54). You can also use 4-ohm speakers as the front speakers when you set “SP IMP.” to “6ΩMIN”.

■ **Connecting speaker cables**

- 1 Remove approximately 10 mm (0.4 in) of insulation from the end of each speaker cable and then twist bare wires of the cable together so that they will not cause a short circuits.**

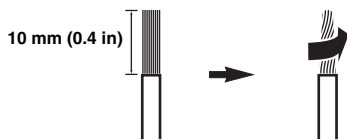

- 2 Loosen the knob, insert the twisted bare wires into the hole and then tighten the knob.**

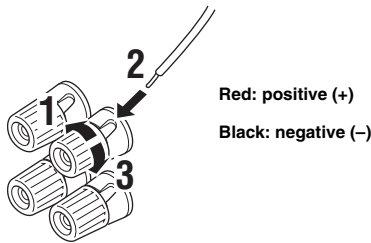

**Connecting the banana plug (Except Korea, U.K., Europe, Russia and Asia models)**

Tighten the knob and then insert the banana plug into the end of the terminal.

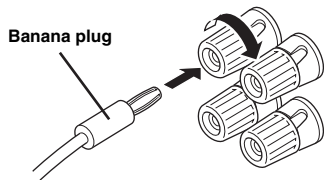

■ **Using bi-amplification connections**

You can make bi-amplification connections to one speaker system which supports bi-amplification connection as shown below. To activate the connections, set “BI-AMP” to “ON” in the advanced setup menu (page 54).

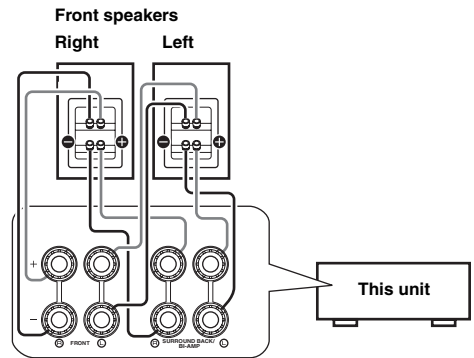

**Caution**

Before making bi-amplification connections, remove any brackets or cables that connect a woofer with a tweeter. Refer to the instruction manuals of speakers for details.

When not making bi-amplification connections, make sure that the brackets or cables are connected before connecting the speaker cables.

**Note**

- You cannot use surround back speakers or extra speakers (presence and Zone2 speakers) when bi-amplification connections are made.

## Information on jacks and cable plugs

This unit has the following input and output jacks. Use jacks and cables appropriate for components that you are connecting.

### ■ Audio jacks

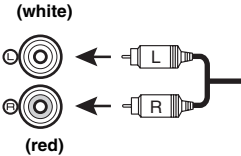
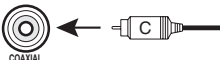
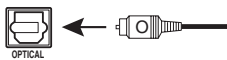
Jack and cables	Description
<b>Analog audio jacks</b> (white) 	To transmit conventional analog stereo audio signals. Use stereo pin cables. Connect red plugs to red jacks (R) and white plugs to white jacks (L).
<b>COAXIAL jacks</b> (orange) 	To transmit coaxial digital audio signals. Use pin cables for digital audio signals.
<b>OPTICAL jacks</b> 	To transmit optical digital audio signals. Use optical fiber cables for optical digital audio signals.

### ■ Video jacks

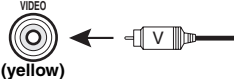
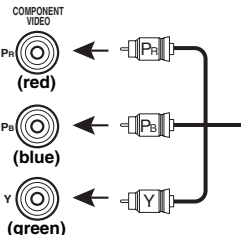
Jack and cables	Description
<b>VIDEO jacks</b> VIDEO (yellow) 	To transmit conventional composite video signals. Use video pin cables.
<b>COMPONENT VIDEO jacks</b> COMPONENT VIDEO Pr (red) Pb (blue) Y (green) 	To transmit component video signals that include luminance (Y), chrominance blue (PB) and chrominance red (PR) components. Use component video cables.

### ■ Video/audio jacks

Jack and cables	Description
<b>HDMI jacks</b> 	To transmit digital video and digital audio signals. Use HDMI cables.



- We recommend that you use a commercially available 19-pin HDMI cable no longer than 5 meters (16 feet) with the HDMI logo printed on it.
- Use a conversion cable (HDMI jack ↔ DVI-D jack) to connect this unit to other DVI components.
- You can check the potential problem about the HDMI connection (page 38).

This unit automatically converts input video signals and outputs the signals to the HDMI OUT jack and MONITOR OUT (COMPONENT VIDEO and VIDEO) jacks (video conversion).

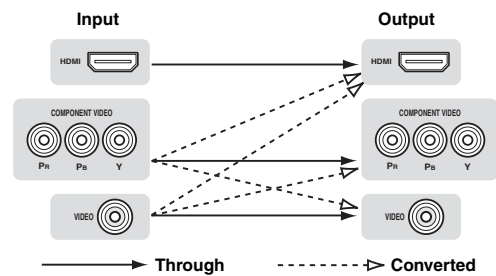

## Connecting a TV monitor or projector

According to the types of video input jacks available on your video monitor (such as a TV or projector), choose one of the connection methods as shown below. When you connect video players such as a DVD player to this unit with an HDMI connection, connect your video monitor to this unit with an HDMI connection.

### Note

- Make sure that this unit and other components are unplugged from the AC wall outlets.

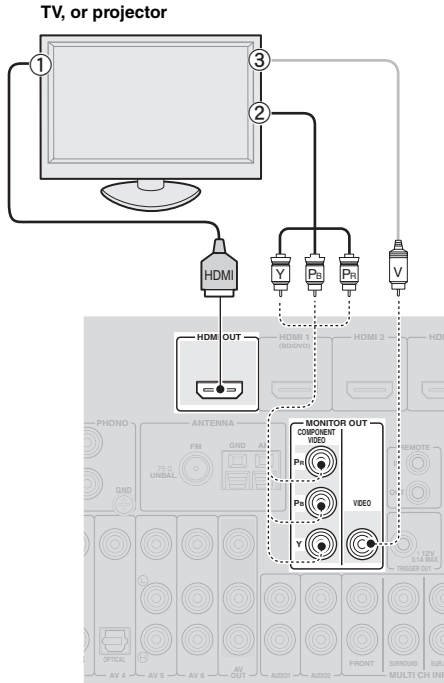

### Outputting TV sounds from this unit

To output sound of a TV from this unit, make connection between one of the AV 1-6 jacks of this unit and an audio output jack of the TV.

If the TV supports an optical digital output, we recommend that you use the AV 1 jack. Connecting to the AV 1 jack allows you to switch an input source to the AV 1 jack with a just a single key operation using the SCENE function (page 23).

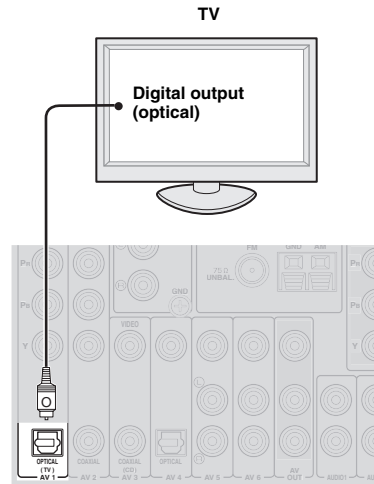

### ■ To connect an HDMI video monitor

Jacks on components	Jacks on this unit
① HDMI input	HDMI OUT



- This unit supports the HDMI control function (page 36). If your TV supports the HDMI control function, you can control this unit with the remote control of your TV.

### ■ To connect component video monitor

Jacks on components	Jacks on this unit
② Component video output	MONITOR OUT (COMPONENT VIDEO)

### ■ To connect composite video monitor

Jacks on components	Jacks on this unit
③ Video input (composite)	MONITOR OUT (VIDEO)



## Connecting other components

This unit has input and output terminals for respective input and output sources. You can reproduce sound and movies from input sources selected with the front panel display or remote control.

### Note

- Make sure that this unit and other components are unplugged from the AC wall outlets.

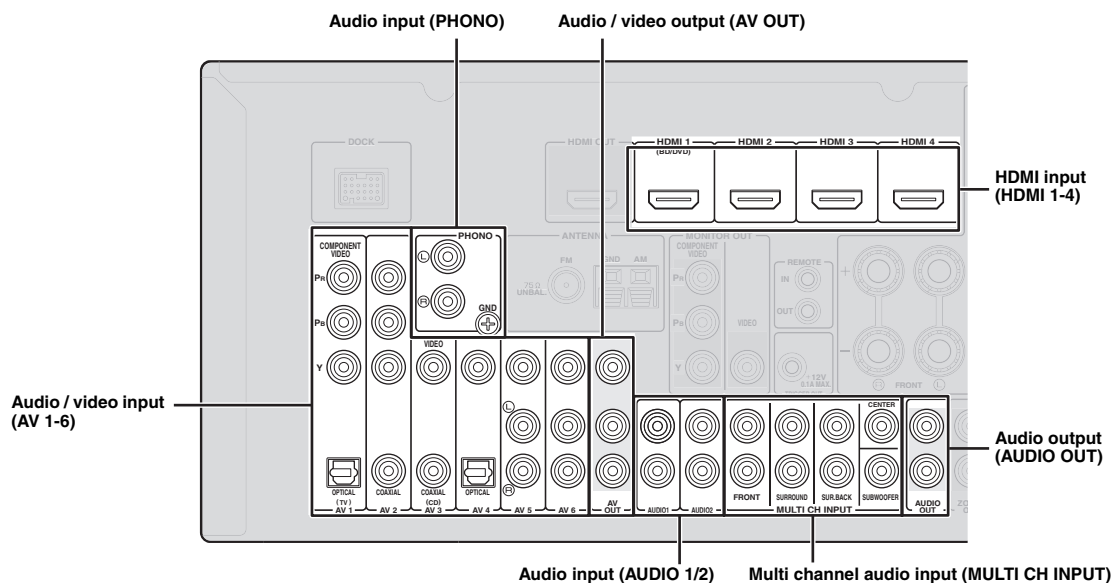

### ■ Audio and video player / Set-top box

Output jacks on the connected external component			Input sources/jacks of this unit	
External component	Signal	Output jack	Input source	Input jack
External component with HDMI output	Audio/Video	HDMI output	HDMI 1 (BD/DVD)	HDMI 1
			HDMI 2	HDMI 2
			HDMI 3	HDMI 3
			HDMI 4	HDMI 4
External component with component video output	Audio	Optical digital output	AV 1 (TV)	OPTICAL
	Video	Component video		COMPONENT VIDEO
External component with composite video output	Audio	Coaxial digital output	AV 2	COAXIAL
	Video	Component video output		COMPONENT VIDEO
	Audio	Coaxial digital output	AV 3 (CD)	COAXIAL
	Video	Composite output		VIDEO
External component with composite video output	Audio	Optical digital output	AV 4	OPTICAL
	Video	Composite output		VIDEO
External component with composite video output	Audio	Analog audio output	AV 5	Analog audio
	Video	Composite output		VIDEO
External component with composite video output	Audio	Analog audio output	AV 6	Analog audio
	Video	Composite output		VIDEO



- Input sources in parentheses are recommended to connect to the respective jacks. If your Yamaha component has the remote in/out terminal, you can switch the input source to that component with a single key operation using the SCENE function (page 23).
- You can change the name of the input source displayed on the front panel display as necessary (page 50).
- See page 51 on how to use the ZONE2 OUT jacks.
- When you connect an external component with analog audio and component video (or composite) output jacks, connect the analog audio output to the AUDIO 1 or AUDIO 2 jacks of this unit while making a video connection (component video or composite). Then select the video to be output when "AUDIO 1" or "AUDIO 2" is selected as the input source (page 39).

**■ Audio player**

Output jacks on the connected external component		Input sources/jacks of this unit	
External component	Output jack	Input source	Input jack
External component with optical digital output	Optical digital output	AV 1 (TV)	OPTICAL
		AV 4	OPTICAL
External component with coaxial digital output	Coaxial digital output	AV 2	COAXIAL
		AV 3 (CD)	COAXIAL
External component with analog audio output	Analog audio output	AV 5	Analog audio
		AV 6	Analog audio
		AUDIO 1	Analog audio
		AUDIO 2	Analog audio
Turntable	Analog audio output	PHONO	Analog audio



- We recommend connecting the coaxial digital output terminal of a CD player to the AV3 jack.
- When connecting a turntable with a low-output MC cartridge to the PHONO jacks, use an in-line boosting transformer or MC-head amplifier.
- Connect your turntable to the GND terminal of this unit to reduce noise in the signal.

**About audio/video output terminals**

Among the analog audio and analog video signals input to this unit via input terminals, the audio/video signals of the selected input sources are output from the AV OUT jacks and AUDIO OUT jacks. An HDMI input signal, COMPONENT VIDEO input signal or digital audio input signal cannot be output.  
 When using the AV OUT jacks: connect an external component to the VIDEO or analog audio terminal.  
 When using the AUDIO OUT jacks: connect an external component to the analog audio terminal.

**■ Connecting a multi-format player or an external decoder**

This unit is equipped with 8 additional input jacks (Front L/R, Center, Surround L/R, Surround Back L/R and Subwoofer) for analog multi-channel input from a multi-format player, external decoder, etc.

**Notes**

- When you select "MULTI CH" as the input source, the digital sound field processor is automatically disabled.
- Since this unit does not redirect signals input at the MULTI CH INPUT jacks to accommodate for missing speakers, connect at least a 5.1-channel speaker system when using this feature.
- You can specify a video signal to be output during a multi-channel audio reproduction (page 39). If your DVD player has analog multi-channel output jacks, connect them to the MULTI CH INPUT jacks while making a video connection (component video or composite).

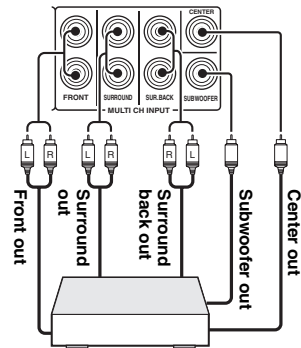

**Multi-format player or external decoder (7.1-channel output)**

## ■ Connecting an external amplifier

If you want to use another amplifier, connect an external amplifier to the PRE OUT jacks. Each PRE OUT jack outputs the same channel signals as the corresponding speaker terminals.

### Note

- When you make connections to the PRE OUT jacks, do not make any connections to the speaker terminals.

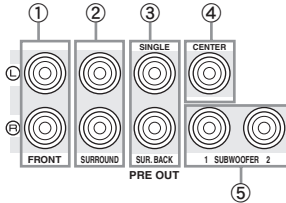

- FRONT PRE OUT jacks**  
Front channel output jacks.
  - SURROUND PRE OUT jacks**  
Surround channel output jacks.
  - SUR.BACK PRE OUT jacks**  
Surround back output jacks. When you only connect one external amplifier for the surround back channel, connect it to the left SUR.BACK (SINGLE) jack.
- 
- To output surround back channel signals at these jacks, set "Surround Speaker" to any parameter except "None" (page 46).
- CENTER PRE OUT jack**  
Center channel output jack.
  - SUBWOOFER PRE OUT 1/2 jack**  
Connect a subwoofer with a built-in amplifier.

## ■ Transmitting/receiving remote control signals

When the components have the capability of the transmission of the remote control signals, connect the REMOTE IN and REMOTE OUT jacks to the remote control input and output jack with the monaural analog mini cable as follows.

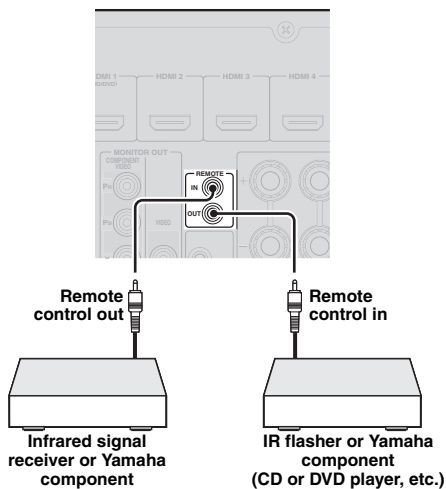

- If connecting a Yamaha component that supports the SCENE control signal reception to the REMOTE OUT jack of this unit, you can start playback on the Yamaha component by using the SCENE function (page 23).
- If connecting a component other than Yamaha products to the REMOTE OUT jack of this unit, set "SCENE IR" to "OFF" in the advanced setup menu (page 54).

## Connecting a Yamaha iPod universal dock or Bluetooth™ wireless audio receiver

This unit has the DOCK terminal, to which you can connect a Yamaha iPod universal dock (YDS-11, sold separately) or a Bluetooth wireless audio receiver (YBA-10, sold separately). You can play an iPod or a Bluetooth component with this unit by connecting it to the DOCK terminal.

Use a dedicated cable for connection between the dock/receiver and this unit.

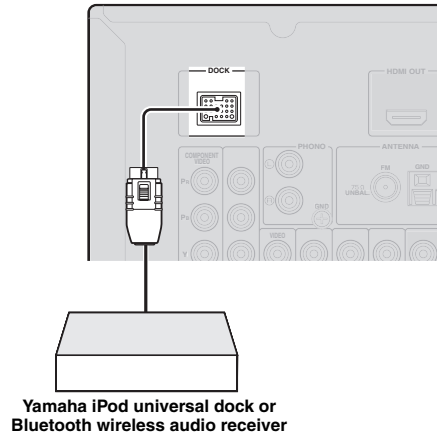

## Connecting a USB storage device

Connect a USB memory device or USB portable audio player to the USB port on the front panel of this unit. For information about USB storage devices supported by this unit, see page 35.

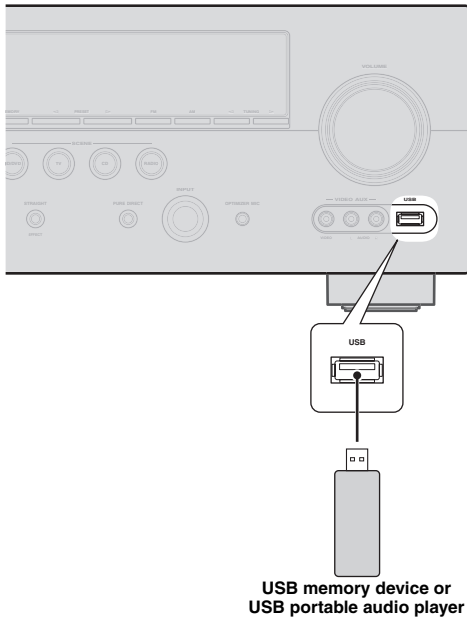

## Connecting the FM and AM antennas

An indoor FM antenna and an AM loop antenna are supplied with this unit. Connect these antennas properly to the respective jacks.

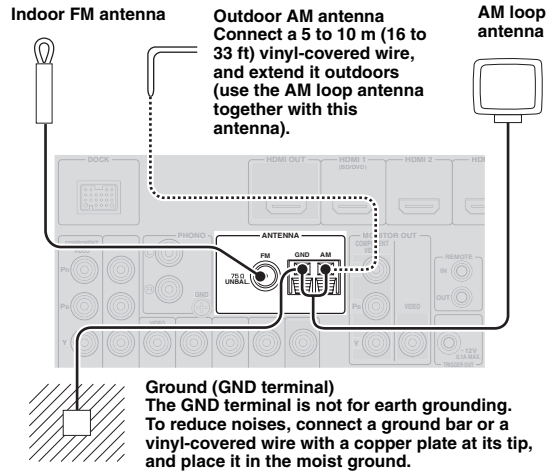

- The supplied antennas are normally sensitive enough to obtain good reception.
- Position the AM loop antenna away from this unit.
- If you cannot get good reception, we recommend that you use an outdoor antenna. For details, consult the nearest authorized Yamaha dealer or service center.
- Always use the AM loop antenna even when the outdoor antenna is connected.

## Using the VIDEO AUX jacks

Use the VIDEO AUX jacks on the front panel to connect a game console or a video camera to this unit. Be sure to turn down the volume of this unit and other components before making connections.

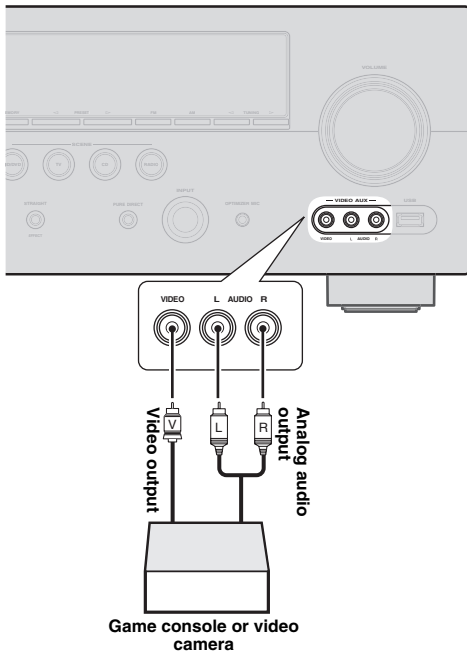

## Assembling the AM loop antenna

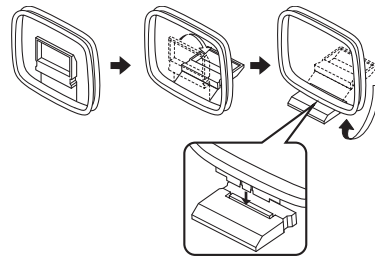

## Connecting the AM loop antenna

The wires of the AM loop antenna have no polarity. You can connect either wire to the AM terminal and the other to the GND terminal.

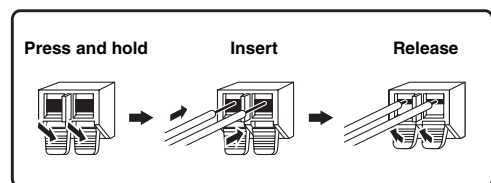

## Connecting the power cable

After all connections are complete, plug the power cable of this unit into an AC wall outlet.

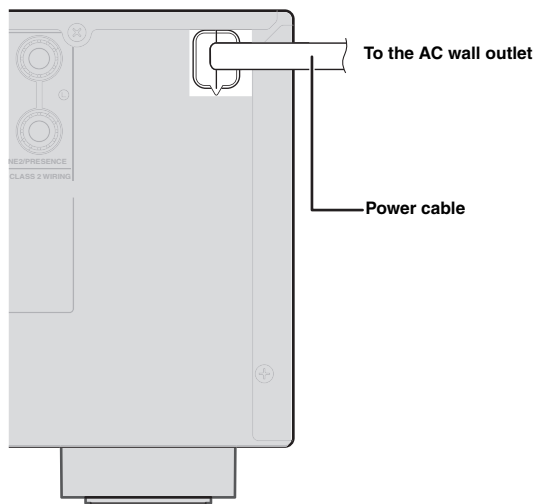

## Turning this unit on and off

- 1 Press **Ⓚ MAIN ZONE ON/OFF** on the front panel (or **16 POWER** on the remote control) to turn on this unit.
- 2 Press **Ⓚ MAIN ZONE ON/OFF** (or **16 POWER**) again to turn off this unit (standby mode).



- The unit needs a few seconds until ready to play back.
- You can also turn on this unit by pressing **Ⓟ SCENE** (or **Ⓢ SCENE**).
- This unit consumes a small amount of electricity even in the standby mode. We recommend disconnecting the power cable from the AC wall outlet.

### Caution

Do not unplug this unit while it is turned on. Doing so may damage this unit or cause the settings of this unit to be saved incorrectly.

# Optimizing the speaker setting for your listening room (YPAO)

This unit has a Yamaha Parametric Acoustic Optimizer (YPAO). With the YPAO, this unit automatically adjusts the output characteristics of your speakers based on speaker position, speaker performance, and the acoustic characteristics of the room. We recommend that you first adjust the output characteristics with the YPAO when you use this unit.

## Caution

- Be advised that it is normal for loud test tones to be output during the “Auto Setup” procedure. Do not allow small children to enter the room during the procedure.
- To achieve the best results, make sure the room is as quiet as possible while the “Auto Setup” procedure is in progress. If there is too much ambient noise, the results may not be satisfactory.



- You can manually adjust the output characteristics of your speakers with “Manual Setup” in the Setup menu (page 45).

## Using Auto Setup

### 1 Check the following points.

Before starting the automatic setup, check the following.

- All speakers and subwoofer are connected properly.
- Headphones are disconnected from this unit.
- The video monitor is connected properly.
- This unit and the video monitor are turned on.
- This unit is selected as the video input source of the video monitor.
- The connected subwoofer is turned on and the volume level is set to about half way (or slightly less).
- The crossover frequency controls of the connected subwoofer are set to the maximum.

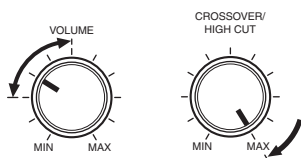

Subwoofer

### 2 Connect the supplied optimizer microphone to the **OPTIMIZER MIC** jack on the front panel.

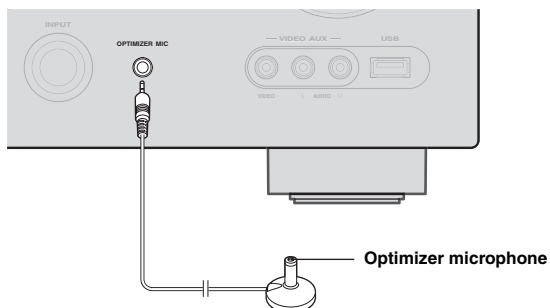

“MIC ON. View GUI MENU” appears on the front panel display.

The GUI screen appears on the video monitor.

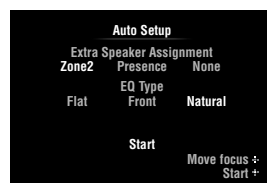

- You can bring up the above menu screen from the Setup menu (page 45).

### 3 Place the optimizer microphone at your normal listening position on a flat level surface with the omni-directional microphone heading upward.

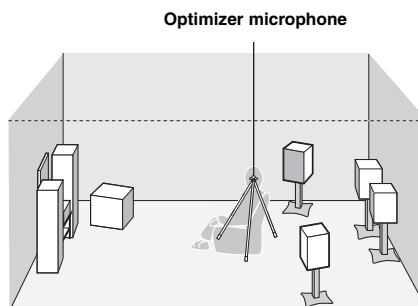

- It is recommended that you use a tripod or something similar to fix the optimizer microphone at the same height as your ears would be when seated in your listening position. You can fix the optimizer microphone to the tripod with the attaching screw of the tripod.

**4 When the speakers are connected to EXTRA SP terminals, press **[F10]Cursor**  $\Delta$  repeatedly to select “Extra Speaker Assignment” and then press **[F10]Cursor**  $\triangleleft/\triangleright$  to select how to use EXTRA SP terminals from “Zone2”, “Presence” or “None”.**

If this unit does not work when you press **[F10]Cursor**, press **[F9]ON SCREEN** once and then operate this unit.

**5 To select sound characteristics for adjustment, press **[F10]Cursor**  $\nabla$  to select “EQ Type” and then press **[F10]Cursor**  $\triangleleft/\triangleright$ .**

If this unit does not work when you press **[F10]Cursor**, press **[F9]ON SCREEN** once and then operate this unit.

This unit has a parametric equalizer that adjusts the output levels for each frequency range. The equalizer is adjusted to produce a cohesive sound field based on automatically measured speaker characteristics. In “EQ Type”, you can select the following parametric equalizer characteristics suitable for the desired sound characteristics.

**Natural**

This adjusts all speakers to achieve natural sound. Select this if sounds in the high frequency range seem too strong when “EQ Type” is set to “Flat”.

**Flat**

This adjusts each speaker to obtain the same characteristics. Select this if your speakers have similar qualities.

**Front**

This adjusts each speaker to obtain the same characteristics as the front left and right speakers. Select this if your front left and right speakers have significantly better qualities than the other speakers.

**6 Press **[F10]Cursor**  $\nabla$  to select “Start” and then press **[F10]ENTER** to start the setup procedure.**

A countdown starts and a measurement starts in 10 seconds. A loud test tone is output during measurement.

**Notes**

- During the automatic setup procedure, do not perform any operation on this unit.
- Press **[F10]Cursor**  $\Delta$  to cancel the automatic setup procedure.

Measurement takes about 3 minutes. To obtain precise results, stay where you will not disturb the measurement, such as to the side of or behind the speakers or outside the room.

When measurement is successfully completed, “YPAO Complete” appears on the front panel display and the measurement result appears on the GUI screen.

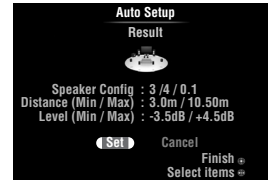

**Speaker Config**

Displays the number of speakers connected to this unit in the following order:  
Total of Front and Center/Total of Surround and Surround Back/Subwoofer

**Distance (Min / Max)**

Displays the speaker distance from the listening position in the following order:  
Closest speaker distance/Farthest speaker distance

**Level (Min / Max)**

Displays the speaker output levels in the following order:  
Lowest speaker output level/Highest speaker output level

**Notes**

- If “Error” appears on the GUI screen during “Auto Setup”, measurement is canceled and the type of error is displayed. For details, see “When an error message is displayed during measurement” (page 22).
- If problems occur during measurement, “Check xx warning(s)” (xx indicates the number of warnings) appears in red. For details, see “When a warning message is displayed after measurement” (page 22).

**7 Press **[F10]ENTER** to confirm the settings.**

The speaker characteristics are adjusted according to measurement results.

To cancel the operation, press **[F10]Cursor**  $\triangleleft/\triangleright$  to select “Cancel” and press **[F10]ENTER**.

When the following screen appears, remove the optimizer microphone. “Auto Setup” is now complete.

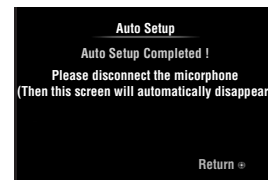

The optimizer microphone is sensitive to heat. Store it in a cool place and away from direct sunlight after measurement. Do not leave it in a place where it will be subjected to high temperatures such as on an AV component.



- If you do not want to apply the measurement results, select “Cancel”.
- Perform “Auto Setup” again if you change the number or positions of speakers.
- If you press **[F10]ENTER** before removing the optimizer microphone, “Auto Setup” of “Speaker Setup” in the Setup menu (page 45) is displayed.

## When an error message is displayed during measurement

If an error is detected during measurement, the measurement is canceled and “Error” appears on the GUI screen. Check the error and solve the problem. For details on each error message, see page 62.

Press **[F10]Cursor** **▽** once, press **[F10]Cursor** **</>** to select “Retry” or “Exit” and then press **[F10]ENTER**.

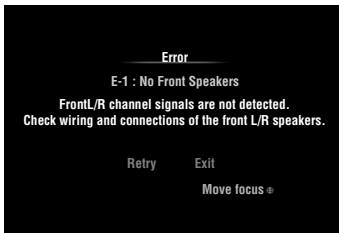

### Retry

Performs “Auto Setup” again.

### Exit

Terminates the measurement and “Auto Setup”.



- When “E-5:NOISY” appears, you can continue measurement. To continue measurement, select “Proceed”. However, we recommend that you solve the problem first and then perform measurement again.

## When a warning message is displayed after measurement

If a problem occurs during measurement, “Check xx warning(s)” appears on the GUI screen. Check the warning and solve the problem. For details on each warning message, see page 63.



- Optimization will not be performed while a warning message is displayed. We recommend that you solve the problem and perform “Auto Setup” again.

**1** Press **[F10]Cursor** **▽ / ▲** to select “Check xx warning(s)” and then press **[F10]ENTER**.

Details of the warning message are displayed. If there are multiple warning messages, you can display the next message using **[F10]Cursor** **>**.

**2** To return to the top result display, press **[F10]ENTER** again.



# BASIC OPERATION

## Playback

### Basic procedure

**1** Turn on external components (TV, DVD player, etc.) connected to this unit.

**2** Rotate the **INPUT** selector (or press **INPUT** selection key) to select an input source.

The name of the selected input source is displayed for a few seconds.

Input source name



- You can also select an input source from the GUI screen (page 24).
- You can change the input source name displayed on the front panel display or GUI screen as necessary (page 50).

**3** Play the external component that you have selected as the source input, or select a radio station on the tuner.

Refer to the operating instructions of the external component for details on playback. For selecting radio stations or playback of an iPod, Bluetooth component or USB storage device using this unit, see the following.

- FM/AM radio tuning (page 30)
- iPod playback (page 32)
- Bluetooth component playback (page 34)
- USB storage device playback (page 35)

**4** Turn the **VOLUME** control (or press **VOLUME +/-**) to adjust the volume.

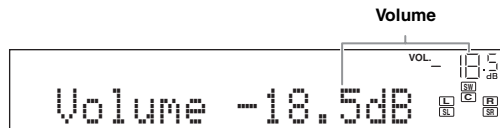

### Note

When you play back a DTS-CD, noise may be output in some conditions, which may cause a speaker malfunction. Make sure that the volume is set to low before starting playback. If noise is output, do the following.

1) When only noise is output

If a DTS bitstream signal is not properly input to this unit, only noise is output. Connect the playback component to this unit by digital connection and play back the DTS-CD. If the condition is not improved, the problem may result from the playback component. Consult the manufacturer of the playback component.

2) When noise is output during playback or skip operation

Before playing back the DTS-CD, display the Option menu after selecting the input source and set "Decoder Mode" to "DTS" (page 38).

### Using the SCENE function

This unit has a SCENE function that allows you to change input sources and sound field programs with one key. Four scenes are available for different usages, such as playing movies or music. The following input sources and sound field programs are provided as the initial factory settings.

Keys	Input source	Sound field program
BD/DVD	HDMI 1	Straight
TV	AV 1	Straight
CD	AV 3	Straight
RADIO	TUNER	7ch Enhancer



- When this unit is on standby, you can turn on this unit by pressing **SCENE** (or **SCENE**).
- If you connect a Yamaha DVD/CD player that has the capability of the SCENE control signals to the REMOTE OUT jack of this unit, you can start playback on the player by using the SCENE function.

### Selecting a SCENE

Press **SCENE** (or **SCENE**).



- You can also select a SCENE from the GUI screen (page 24).

## Registering input source/sound field program

Select the desired input source/sound field program and then press and hold **ⓅSCENE** (or **ⓈSCENE**) key to edit until “SET Complete” appears on the front panel display.



- If you change the input source setting, register the remote control code of an external component to the input source (page 53).

## Switching remotely controlled external components linked to scene selections

You can operate an external component with the remote control of this unit by setting a remote control code for the external component for each input source. Setting remote control codes for desired input sources allows you to switch between external components linked to scene selections.

- 1 Register the remote control code of an external component to the desired input source (page 53).

### Note

- This feature is not available for the TUNER input source.

- 2 While holding down the desired **ⓈSCENE** key, press and hold the **ⓂInput selection** key to which you registered a remote control code in step 1.

From now on the external component can be remotely controllable just by selecting a scene.

## Selecting a source on the GUI screen

- 1 Press **ⓅON SCREEN** on the remote control. The GUI screen appears on the video monitor.

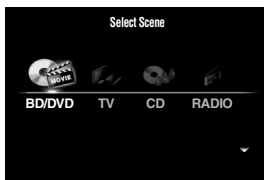

- 2 Use **ⓂCursor**  $\Delta / \nabla$  repeatedly to switch the page and **ⓂCursor**  $\triangleleft / \triangleright$  repeatedly to select the desired source.

Category	Source
Select Scene	BD/DVD, TV, CD, RADIO
Select Media	USB, DOCK, TUNER, PHONO, V-AUX, MULTI CH
Select Input	HDMI1-4, AV1-6, AUDIO1/2



- If an input source you want to select is available in “Select Scene”, you can select the desired input source and sound field program at once.

- 3 Press **ⓂENTER**.

## Muting audio output

- 1 Press **ⓂMUTE** on the remote control to mute the audio output.

The MUTE indicator on the front panel display flashes while audio output is muted.

- 2 Press **ⓂMUTE** again to resume audio output.

## Adjusting high/low frequency sounds (tone control)

You can adjust the balance of the high frequency range (Treble) and low frequency range (Bass) of sounds output from the front left and right speakers to obtain desired tone.

- 1 Press **ⓂTONE CONTROL** on the front panel repeatedly to select “Treble” or “Bass”.

The current setting is displayed on the front panel display.

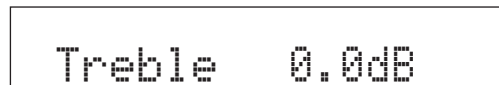

- 2 Rotate the **ⓂPROGRAM** selector to adjust the frequency range.

Control range: -10.0 dB to +10.0 dB

The display returns to the previous screen automatically in few seconds.

### Notes

- The tone control settings are not effective when this unit is in the Pure Direct mode or “MULTI CH” is selected as an input source.
- If you set the balance extremely off, sounds may not match those from other channels well.

## Enjoying pure hi-fi sound

Use Pure Direct mode to enjoy the pure high fidelity sound of the selected source. When Pure Direct mode is activated, this unit plays back the selected source with the least circuitry.

Press **ⓂPURE DIRECT** (or **ⓂPURE DIRECT**) to turn the Pure Direct mode on or off.

**ⓂPURE DIRECT** lights up when you set Pure Direct mode on.

The following features are disabled in the Pure Direct mode.

- sound field program, tone control
- display and operation of the Option menu and Setup menu
- multi-zone function



- The font panel display automatically turns off while this unit is in the Pure Direct mode.

## Using your headphones

Plug your headphones in the **PHONES** jack on the front panel.

When you select a sound field program while using the headphones, the mode is automatically set to SILENT CINEMA mode.

### Notes

- When you connect headphones, no signals are output at the speaker terminals.
- When multi-channel signals are processed, sounds in all channels are divided to left and right channels. When “MULTI CH” is selected as the input source, only front L/R sounds are output from the headphones.

## Displaying input signal information

When HDMI 1-4 or AV1-4 is selected as the input source, you can display audio/video signal information.



- Input signal information is displayed on both the GUI screen and front panel display.

**1** Select the desired input source and then press **OPTION** on the remote control.

The Option menu for the selected input source is displayed (page 37).

**2** Press **Cursor**  $\Delta$  /  $\nabla$  to select “Signal Info” and then press **ENTER**.

Information on the input signal is displayed. See page 38 for details about each information.

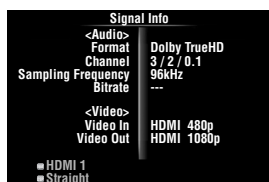

### Note

- If an HDMI related error occurs, error information is displayed at the bottom of the screen.

**3** To exit the Option menu, press **OPTION**.

## Changing information on the front panel display

Press **INFO** (or **INFO**) repeatedly.

Available information differs depending on the selected input source.

For example, if you select HDMI1 input and display “DSP Program”, the following screen appears on the front panel display.



Input source	Information
HDMI1-4	Input
AV1-6	DSP Program
AUDIO1/2	Audio Decoder
V-AUX	
PHONO	
iPod (DOCK) (simple remote mode)	
BLUETOOTH (DOCK)	
USB	(on play information display)
iPod (DOCK) (menu browse mode)	DSP Program, Audio Decoder, Song, Artist, Album
	(on GUI screen)
	List
TUNER	Frequency, DSP Program, Audio Decoder
MULTI CH	Input

# Enjoying the sound field programs

This unit is also equipped with a Yamaha digital sound field processing (DSP) chip. You can enjoy multi-channel sounds for almost all input sources using various sound field programs stored on the chip and a variety of surround decoders.

## Selecting sound field programs

### ■ Selecting a sound field program on the front panel

Rotate the **PROGRAM** selector to select a desired sound field program.

### ■ Selecting a sound field program with the remote control

Perform the following operations depending on the category of the sound field programs.

- Sound field programs for movies/TV programs ..... Press **[7] MOVIE** repeatedly.
- Sound field programs for music ..... Press **[7] MUSIC** repeatedly.
- Stereo reproduction ..... Press **[7] STEREO** repeatedly.
- Multi-channel stereo reproduction ..... Press **[7] STEREO** repeatedly.
- Compressed music enhancer ..... Press **[7] STEREO** repeatedly.
- Surround decoder ..... Press **[7] SUR.DECODE** repeatedly.

For example, if you select “Sci-Fi”, the following screen appears on the front panel display.

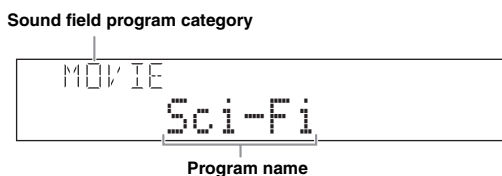

### Notes

- Sound field programs are stored for each input source. When you change the input source, the sound field program previously selected for that input source is applied again.
- When you play back the Dolby Digital Plus, Dolby TrueHD, DTS Express, DTS-HD Master Audio, DTS-HD High Resolution Audio sources or audio signals with sampling frequency of higher than 96 kHz, the straight decode mode (page 29) is automatically selected.

## Sound field program descriptions

This unit provides sound field programs for multiple categories including music, movies and stereo reproduction. Select a sound field program based on your listening preference, not merely on the name of the program, etc.



- You can check what speakers are currently outputting signals with the speaker indicators on the front panel display (page 6).
- Each program can adjust sound field elements (sound field parameters). For details, see page 40.
- **CINEMA DSP** in the table indicates the sound field program with CINEMA DSP.

### For movie/TV program sources (MOVIE)



Program	Descriptions
<b>Standard</b>	This program creates a sound field emphasizing the surrounding feeling without disturbing the original acoustic positioning of multi-channel audio such as Dolby Digital and DTS. It has been designed with the concept of “an ideal movie theater”, in which the audience is surrounded by beautiful reverberations from the left, right and rear.
<b>Spectacle</b>	This program represents the spectacular feeling of large-scale movie productions. It reproduces a broad theater sound field matching the cinemascope and wider-screen movies with an excellent dynamic range from very small to extremely large sound.
<b>Sci-Fi</b>	This program clearly reproduces the finely elaborated sound design of the latest science fiction and special effects-featuring movies. You can enjoy a variety of cinematographically created virtual spaces reproduced with clear separation between dialog, sound effects and background music.
<b>Adventure</b>	This program is ideal for precisely reproducing the sound design of action and adventure movies. The sound field restrains reverberations but puts emphasis on reproducing a powerful space expanded widely to the left and right. The reproduced depth is also restrained relatively to ensure the separation between audio channels and the clarity of the sound.

Program	Descriptions
<b>Drama</b>	This sound field features stable reverberations that match a wide range of movie genres from serious dramas to musicals and comedies. The reverberations are modest but offer an optimum 3D feeling, reproducing effects tones and background music softly but cubically around clear words and center positioning in a way that does not fatigue the listener even after long hours of viewing.
<b>Mono Movie</b>	This program is provided for reproducing monaural video sources such as a classic movie in an atmosphere of a good old movie theater. The program produces the optimum expansion and reverberation to the original audio to create a comfortable space with a certain sound depth.
<b>Sports</b>	This program allows the listeners to enjoy stereo sport broadcasts and studio variety programs with enriched live feeling. In sports broadcasts, the voices of the commentator and sportscaster are positioned clearly at the center while the atmosphere of the stadium expands in an optimum space to offer the listeners with a feeling of presence in the stadium.
<b>Action Game</b>	This sound field has been suitable for action games such as car racing and FPS games. It uses the reflection data that limits the effects range per channel in order to offer a powerful playing environment with a being-there feeling by enhancing various effects tones while maintaining a clear sense of directions.
<b>Roleplaying Game</b>	This sound field has been suitable for role-playing and adventure games. It combines the sound field effects for movies and the sound field designs for “Action Game” to represent the depth and 3D feeling of the field during play, while offering movie-like surround effects in the movie scenes in the game.

**For audio music sources (MUSIC)**



Program	Descriptions
<b>Hall in Munich</b>	This sound field simulates a concert hall with approximately 2500 seats in Munich, using stylish wood for the interior finishing as normal standards for European concert halls. Fine, beautiful reverberations spread richly, creating a calming atmosphere. The listener’s virtual seat is at the center left of the arena.
<b>Hall in Vienna</b>	This is an approximately 1700-seated, middle-sized concert hall with a shoebox shape that is traditional in Vienna. Pillars and ornate carvings create extremely complex reflections from all around the audience, producing a very full, rich sound.
<b>Chamber</b>	This program creates a relatively wide space with a high ceiling like an audience hall in a palace. It offers pleasant reverberations that are suitable for courtly music and chamber music.
<b>Cellar Club</b>	This program simulates a live house with a low ceiling and homey atmosphere. A realistic, live sound field features powerful sound as if the listener is in a row in front of a small stage.
<b>The Roxy Theatre</b>	This is the sound field of a rock music live house in Los Angeles, with approximately 460 seats. The listener’s virtual seat is at the center left of the hall.
<b>The Bottom Line</b>	This is the sound field at stage front in The Bottom Line, that was a famous New York jazz club once. The floor can seat 300 people to the left and right in a sound field offering real and vibrant sound.
<b>Music Video</b>	This sound field offers an image of a concert hall for live performance of pop, rock and jazz music. The listener can indulge oneself in a hot live space thanks to the presence sound field that emphasizes the vividness of vocals and solo play and the beat of rhythm instruments, and to the surround sound field that reproduces the space of a big live hall.

**For stereo reproduction (STEREO)**

Program	Descriptions
<b>2ch Stereo</b>	Use this program to mix down multi-channel sources to 2 channels.



- When multi-channel signals are input, they are downmixed to 2 channels and output from the front left and right speakers.

## For multi-channel stereo reproduction (STEREO)



Program	Descriptions
<b>7ch Stereo</b>	Use this program to output sound from all speakers. When you play back multi-channel sources, this unit downmixes the source to 2 channels and then outputs the sound from all speakers. This program creates a larger sound field and is ideal for background music at parties, etc.

## Compressed Music Enhancer (ENHANCER)

Program	Descriptions
<b>Straight Enhancer</b>	Use this program to enhance the sound nearest to the original depth and width of the 2-channel or multi-channel compression artifacts.
<b>7ch Enhancer</b>	Use this program to play back compression artifacts in 7-channel stereo.

## Surround decode mode (SUR. DECODE)

Select this program to playback sources with selected decoders. You can playback 2-channel sources on multi-channels.

Decoder	Descriptions
<b>Pro Logic</b>	Dolby Pro Logic decoder suitable for all kinds of sources.
<b>PLIIX Movie / PLII Movie</b>	Dolby Pro Logic IIX (or Dolby Pro Logic II) decoder suitable for movies. If your listening environment is as follows, you cannot select the Dolby Pro Logic IIX decoder. <ul style="list-style-type: none"> <li>• When the surround back speakers are not connected</li> <li>• When headphones are connected</li> </ul>
<b>PLIIX Music / PLII Music</b>	Dolby Pro Logic IIX (or Dolby Pro Logic II) decoder suitable for music. If your listening environment is as follows, you cannot select the Dolby Pro Logic IIX decoder. <ul style="list-style-type: none"> <li>• When the surround back speakers are not connected</li> <li>• When headphones are connected</li> </ul>
<b>PLIIX Game / PLII Game</b>	Dolby Pro Logic IIX (or Dolby Pro Logic II) decoder suitable for games. If your listening environment is as follows, you cannot select the Dolby Pro Logic IIX decoder. <ul style="list-style-type: none"> <li>• When the surround back speakers are not connected</li> <li>• When headphones are connected</li> </ul>
<b>Neo:6 Cinema</b>	DTS decoder suitable for movies.
<b>Neo:6 Music</b>	DTS decoder suitable for music.



- An input source is played back in straight decode mode (page 29) when "MULTI CH" is selected as the input source.

## Enjoying unprocessed input sources (Straight decode mode)

In straight decode mode, sounds are reproduced without sound field effect. 2-channel stereo sources are output from only the front left and right speakers. Multi-channel input sources are decoded straight into the appropriate channels and multi-channel sounds are reproduced without a sound field effect.

**1 To enable straight decode mode, press**  
**⊙STRAIGHT (or 7 STRAIGHT).**  
 “Straight” appears on the front panel display.

**2 To cancel straight decode mode, press**  
**⊙STRAIGHT (or 7 STRAIGHT) again.**  
 A sound field program name appears on the front panel display, and sound is reproduced with that sound field effect.

## Enjoying sound field programs without surround speakers (Virtual CINEMA DSP)

Virtual CINEMA DSP allows you to enjoy DSP sound field surround effects even without any surround speakers by using virtual surround speakers. You can even enjoy Virtual CINEMA DSP using a minimal two-speaker system that does not include a center speaker. When “Surround Speaker” in the Setup menu is set to “None” (page 46), this unit operates in Virtual CINEMA DSP mode.

### Note

- Virtual CINEMA DSP is not available in the following conditions even if you set “Surround Speaker” to “None” (page 46).
  - headphone plug is connected to the PHONES jack.
  - 7ch Stereo of the field sound program is selected.
  - Pure Direct mode or straight decode mode is used.

## Enjoy sound field programs with headphones (SILENT CINEMA™)

SILENT CINEMA allows you to enjoy multi-channel sources with your headphones. SILENT CINEMA mode is automatically selected when you connect the headphone plug to the PHONES jack.

### Note

- SILENT CINEMA mode is not available in the following conditions.
  - 2ch Stereo of the sound field program is selected.
  - Pure Direct mode or straight decode mode is selected.

## Using CINEMA DSP 3D mode

CINEMA DSP 3D mode creates the intensive and accurate stereoscopic sound field in the listening room. To use this unit in CINEMA DSP 3D mode, presence speakers are required. Connect the presence speakers to the EXTRA SP terminals, perform the following settings and then select a CINEMA DSP related sound field program.

- Disconnect the headphones from the PHONES jack.
- Set “Extra Speaker Assignment” to “Presence” (page 46).
- Set “3D DSP” to “On” (page 40).

When the sound field program runs in CINEMA DSP 3D mode, the 3D indicator on the front panel display lights up.

# FM/AM tuning

The FM/AM tuner of this unit provides the following two modes for tuning.

## ■ Frequency tuning mode

You can tune in to a desired FM/AM station by searching or specifying its frequency.

## ■ Preset tuning mode

You can preset the frequencies of FM/AM stations by registering them to specific numbers, and later just select those numbers to tune in.

### Note

- Adjust the FM/AM antennas connected to this unit for the best reception.

## Tuning in to the desired FM/AM station (Frequency tuning)

- 1 Rotate the **ⓇINPUT** selector (or press **4 TUNER**) to select “TUNER” as the input source.
- 2 Press **ⓄFM (5 FM)** or **ⓄAM (5 AM)** to select a band.  
“FM” or “AM” appears on the front panel display according to the band that you have selected.
- 3 Press **ⓇTUNING </>** (or **5 TUNING Δ / ▽**) to specify the frequency.  
To adjust the frequency to a higher range, press **>** (or **Δ**). To adjust it to the lower range, press **<** (or **▽**).  
The TUNED indicator on the front panel display lights up when the tuner is tuned in to a station. The STEREO indicator also lights up if the program being broadcasted is in stereo.

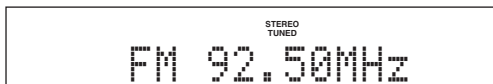

The frequency changes in the following manner according to how you press **ⓇTUNING </>** (or **5 TUNING Δ / ▽**).

### When you press the key more than 1 second

The tuner searches the frequency of a station that is detectable around the current frequency. This is effective when the tuner can receive strong signals without any interference. Once the search starts, release the key. When you keep holding the key, the search continues even when a station is detected. This is useful when you want to tune in to a specific station.

### When you press and release the key

The tuner increases or decreases the frequency in steps. Use this method when the tuner cannot receive strong signals and stations are skipped during the search.



- You can switch between stereo and monaural for FM broadcast in the Option menu (page 38).

- 4 To tune in by direct frequency tuning, press **12 Numeric keys** to enter the frequency of the station.

### Notes

- When you press **12 Numeric keys** during preset tuning, a preset number is selected. Set tuning mode to frequency tuning mode using **ⓇTUNING/CH </>** (or **5 TUN./CH Δ / ▽**) prior to the operation.
- “Wrong Station!” appears on the front panel display when you enter a frequency that is out of receivable range. Make sure that the entered frequency is correct.
- You do not need enter zero if it comes at the end of a decimal number. For example, enter “925” for “92.50 MHz” or “94” for “94.00 MHz”.

## Registering FM/AM stations and tuning in (Preset tuning)

You can register up to 40 FM/AM stations (Preset).

### Registering stations by automatic station preset

The tuner automatically detects FM stations with strong signals and registers up to 40 stations. To register AM stations, use manual station preset.

- 1 Rotate the **ⓇINPUT** selector (or press **4 TUNER**) to select “TUNER” as the input source.
- 2 Press **18 OPTION** on the remote control.  
The Option menu for “TUNER” is displayed (page 37).
- 3 Select “Auto Preset” and then press **10 ENTER**.

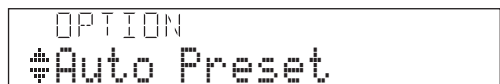

Automatic station preset starts about 5 seconds later from the lowest frequency upwards.



- You can select the preset number at which the preset starts by pressing **5 PRESET Δ / ▽** or **10 Cursor Δ / ▽** while “READY” is displayed on the front panel display.
- To cancel registration, press **10 RETURN**.

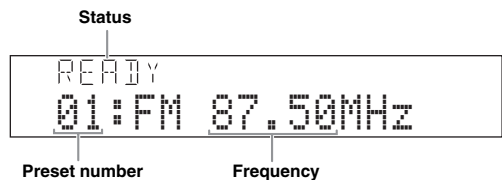

During the automatic station preset, “MEMORY” appears in the front panel display each time a station is registered.

When registration is complete, “FINISH” appears and then the display returns to the Option menu.



To return the display to the original state, press **[18]OPTION**.

## Registering stations by manual station preset

You can manually register FM stations with weak signals or AM stations.

### 1 Tune in to the desired station (page 30).

### 2 Press **[E]MEMORY** (or **[5]MEMORY**).

“Manual Preset” appears on the front panel display, followed soon by the preset number to which the station will be registered.



- By holding down **[E]MEMORY** (or **[5]MEMORY**) for more than 2 seconds, you can skip the following steps and automatically register the selected station to an empty preset number (next to the lastly-registered preset number).

### 3 Press **[F]PRESET </>** (or **[5]PRESET Δ / ▽**) to select the preset number to which the station will be registered.

When you select a preset number to which no station is registered, “Empty” appears. When you select a preset number to which any station has been already registered, the frequency of the station is displayed.

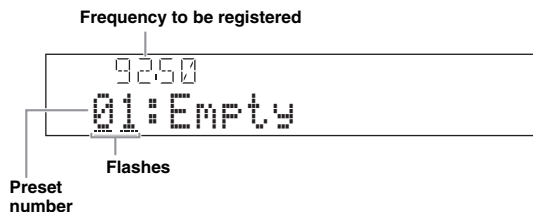

- You can also select a preset number using the **[12]Numeric keys**.

### 4 Press **[E]MEMORY** (or **[5]MEMORY**).

When registration is complete, the display returns to the original state.



- To cancel registration, press **[10]RETURN** or leave this unit without any operations for about 30 seconds.

## Calling a preset station (Preset tuning)

You can call preset stations registered by automatic station preset or manual station preset.

Press **[F]PRESET </>** (or **[5]PRESET Δ / ▽**) to select a preset number.



- Preset numbers to which no stations are registered are skipped.
- “No Presets” or “No Presets in Memory” is displayed if no stations are registered.
- You can directly select a preset number by pressing **[12]Numeric keys** while calling a preset station. “Empty” appears on the display if you enter a preset number to which no station is registered. “Wrong Num.” appears if you enter an invalid number.
- When you press **[12]Numeric keys** during normal tuning, a frequency is entered. Set tuning mode to preset tuning mode using **[F]PRESET </>** (or **[5]PRESET Δ / ▽**) prior to the operation.

## Clearing preset stations

### 1 Rotate the **[R]INPUT** selector (or press **[4]TUNER**) to select “TUNER” as the input source.

### 2 Press **[18]OPTION** on the remote control.

The Option menu for “TUNER” is displayed (page 37).

### 3 Press **[10]Cursor Δ / ▽** to select “Clear Preset” and then press **[10]ENTER**.

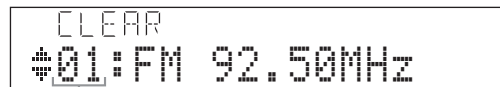

Preset number



- To cancel the operation and return to the Option menu, press **[10]RETURN**.

### 4 Press **[10]Cursor Δ / ▽** to select a preset number to reset and then press **[10]ENTER**.

The preset station registered to the selected preset number is cleared. To clear the registration of multiple preset numbers, repeat step 4.

### 5 To exit the Option menu, press **[18]OPTION**.

# Using iPod™

Once you have stationed your iPod in a Yamaha iPod universal dock (such as the YDS-11, sold separately) connected to the DOCK terminal on the rear panel of this unit (page 17), you can enjoy playback of your iPod using the supplied remote control or the menu displayed on the GUI screen. You can also use the Compressed Music Enhancer mode of this unit to improve the sound quality of the compression artifacts (such as MP3 format) stored on your iPod (page 28).

## Notes

- iPod touch, iPod (Click and Wheel including iPod classic), iPod nano, and iPod mini are supported.
- Some features may not be compatible depending on the model or the software version of your iPod.
- Some features may not be available depending on the model of Yamaha iPod universal dock. The following sections describe the procedure when using the YDS-11.



- Once the connection between your iPod and this unit is complete, “iPod connected” appears on the front panel display.
- For a complete list of status messages that appear on the front panel display and GUI screen, see the “iPod” section on page 60.

## Controlling iPod™

You can control your iPod when you set it in the iPod universal dock and switch the input source to DOCK. The operations of your iPod can be done with the aid of the video display (menu browse mode) or without it (simple remote mode).

When you connect your iPod to this unit, you can perform the following operations with the remote control.

Key	Function
ENTER	Subsequent menu
△	Menu up
▽	Menu down
◀	Previous menu
▶	Subsequent menu
◀◀	Search backward (Press and hold)
▶▶	Search forward (Press and hold)
▶▶▶	Skip forward
◀◀◀	Skip backward
□	Stop
⏸	Pause (Menu browse mode) Play/Pause (Simple remote mode)
▶	Play (Menu browse mode) Play/Pause (Simple remote mode)
⏏	Switch between Menu browse mode and Simple remote mode

## Controlling iPod in simple remote mode

You can perform basic iPod operations (play, stop, skip, etc.) using the supplied remote control without displaying the menu on the GUI screen. You can also directly control your iPod in this mode.

## Controlling iPod in menu browse mode

You can browse song or video files stored on your iPod using the GUI screen. You cannot directly control your iPod in this mode.



- “\_”(underscore) is displayed for characters that this unit cannot display.

**1** Rotate the **INPUT** selector (or press **DOCK**) to select “iPod” (**DOCK**) as the input source.

**2** Press **DISPLAY** on the remote control. The following screen appears on the GUI screen.

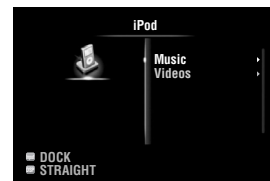

**3** Press **Cursor** **△** / **▽** to select “Music” or “Videos” and then press **Cursor** **▶**.

- Select “Music” to browse music files.
- Select “Videos” to browse video files.

## Note

- The “Videos” menu does not appear unless the both your iPod and Yamaha iPod universal dock support the video browsing feature.

- 4 Press **[10]Cursor**  $\Delta$  /  $\nabla$  /  $\triangleleft$  /  $\triangleright$  to select a menu item and then press **[10]ENTER** to start playback.

#### Menu items of “Music”

Playlists, Artists, Albums, Songs, Genres, Composers

- Playlists > Songs
- Artists > Albums > Songs
- Albums > Songs
- Songs
- Genres > Artists > Albums > Songs
- Composers > Albums > Songs

#### Menu items of “Videos”

Menu items vary depending on the files stored on your iPod.

#### ■ Play information display

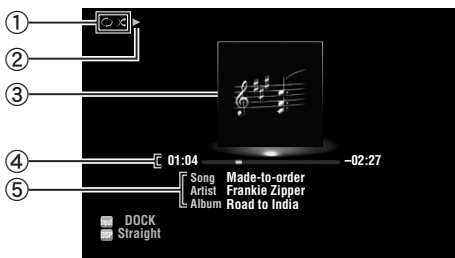

- ① Shuffle and repeat icons
- ②  $\blacktriangleright$  (playback),  $\parallel$  (pausing),  $\blacktriangleright\blacktriangleright$  (search forward) and  $\blacktriangleleft\blacktriangleleft$  (search backward)
- ③ Album art (image of CD jacket, etc)
- ④ Elapsed time, progress bar, remaining time
- ⑤ Song title, artist name, album title



- You can switch the information displayed on the front panel display by pressing **[10]INFO** (or **[6]INFO**).
- Album arts are available only when the file contains image data.

## Shuffle/repeat playback

When controlling iPod in simple remote mode, operate the iPod directly to set the shuffle and repeat playback.

- 1 Press **[20]DISPLAY** to switch to menu browse mode while “DOCK” is selected as the input source.
- 2 Press **[18]OPTION** on the remote control. The Option menu for “iPod” is displayed (page 37).
- 3 Press **[10]Cursor**  $\Delta$  /  $\nabla$  to select “Shuffle” or “Repeat” and then press **[10]ENTER**.
- 4 Press **[10]Cursor**  $\triangleleft$  /  $\triangleright$  to select the desired playback style.

#### Shuffle:

- Select “Off” if you do not want to play back in random order.
- Select “Songs” to play back songs in random order.
- Select “Albums” to play back albums in random order.

#### Repeat:

- Select “Off” if you do not want to play back repeatedly.
- Select “One” to repeat each song.
- Select “All” to repeat all songs.

To return to the previous screen, press **[10]RETURN**.



- When the shuffle function is on, “ $\times$ ” appears on the GUI screen.
- When “Repeat” is set to “One” or “All”, “ $\odot$ ” or “ $\circ$ ” appears on the GUI screen.

# Using Bluetooth™ components

You can connect a Yamaha Bluetooth wireless audio receiver (such as YBA-10, sold separately) to the DOCK terminal of this unit and enjoy the music contents stored in your Bluetooth component (such as a portable music player) without wiring between this unit and the Bluetooth component. You need to perform “Pairing” the connected Bluetooth wireless audio receiver and your Bluetooth component in advance.

## Note

- This unit supports A2DP (Advanced Audio Distribution Profile) of the Bluetooth profile.

## Pairing the Bluetooth™ wireless audio receiver and your Bluetooth component

“Pairing” refers to the operation of registering a Bluetooth component for Bluetooth communications. Pairing must be performed when using a Bluetooth component with the Bluetooth wireless audio receiver connected to this unit for the first time or if the pairing data has been deleted.



- You only need the pairing operation for the first time that you use the Bluetooth component with the Bluetooth wireless audio receiver.
- Pairing requires operations on this unit and on the other component with which Bluetooth communications are to be established. If necessary, refer to the other component’s operating instructions.

### ■ Pairing the Bluetooth™ wireless audio receiver and your Bluetooth™ component

To ensure security, a time limit of 8 minutes is set for the pairing operation. You are recommended to read and fully understand all the instructions before starting.

**1 Rotate the  $\text{\textcircled{R}}$ INPUT selector (or press  $\text{\textcircled{4}}$ DOCK) to select “BLUETOOTH” (DOCK) as the input source.**

**2 Turn on the Bluetooth component you want to pair with and set it to pairing mode.**

For details on operation of the Bluetooth component, refer to the manual supplied with it.

**3 Press  $\text{\textcircled{18}}$ OPTION on the remote control.**  
The Option menu for “BLUETOOTH” is displayed (page 37).

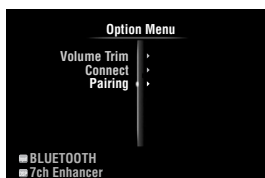

**4 Press  $\text{\textcircled{10}}$ Cursor  $\nabla$  to select “Pairing” and then press  $\text{\textcircled{10}}$ ENTER.**

“Searching” appears and the pairing operation starts.



- To cancel pairing, press  $\text{\textcircled{10}}$ RETURN.
- You can also start pairing operation by holding down  $\text{\textcircled{E}}$ MEMORY on the front panel.

**5 Make sure the Bluetooth component recognizes the Bluetooth wireless audio receiver.**

If the Bluetooth component detects the Bluetooth wireless audio receiver, “YBA-10 YAMAHA” (example) appears in the Bluetooth device list.

**6 Select the Bluetooth wireless audio receiver in the Bluetooth device list, and enter a pass key “0000” into the Bluetooth component.**

When pairing is complete, “Completed” appears on the front panel display.



- The Yamaha Bluetooth wireless audio receiver can be paired with up to eight Bluetooth components. When pairing is conducted successfully with a ninth component and the pairing data is registered, the pairing data for the least recently used other component is cleared.

## Playback of the Bluetooth™ component

**1 Rotate the  $\text{\textcircled{R}}$ INPUT selector (or press  $\text{\textcircled{4}}$ DOCK) to select “BLUETOOTH” (DOCK) as the input source.**

**2 Press  $\text{\textcircled{18}}$ OPTION on the remote control.**

**3 Press  $\text{\textcircled{10}}$ Cursor  $\nabla$  to select “Connect” and then press  $\text{\textcircled{10}}$ ENTER.**

After you execute “Connect”, communication with the Bluetooth component is established. When the connected Bluetooth wireless audio receiver recognizes the Bluetooth component, “BT Connected” appears on the front panel display.



- When you press  $\text{\textcircled{10}}$ ENTER on the remote control, the connected Bluetooth wireless audio receiver searches and connects to the last connected Bluetooth component. If the Bluetooth wireless audio receiver cannot find the Bluetooth component, “Not found” appears on the front panel display.
- To disconnect the Bluetooth wireless audio receiver from the Bluetooth component, display the Option menu again, select “Disconnect” and then press  $\text{\textcircled{10}}$ ENTER.

**4 Start playback of the Bluetooth component.**

# Using USB storage devices

You can enjoy playback of WAV (PCM format only), MP3, WMA, MPEG-4 AAC and FLAC files stored on your USB memory device or USB portable player connected to the USB port on the front panel of this unit. This unit supports USB mass storage class devices (FAT 16 or FAT 32 format, except USB HDDs).

## Notes

- You can play back only the files stored in the first partition.
- Some files may not be playable depending on models and types of USB storage devices.

## Playback of the USB storage device

**1** Connect your USB storage device to the **USB** port on the front panel (page 18).

**2** Rotate the **INPUT** selector (or press **4** **USB**) to select **"USB"** as the input source. The GUI screen appears on the video monitor.



If you have connected the USB storage device to this unit before, playback of the music file played at the last time automatically starts.

**3** Press **10** **Cursor**  $\Delta$  /  $\nabla$  /  $\triangleleft$  /  $\triangleright$  to select a music file to play back.

- To select a file or folder, press **10** **Cursor**  $\Delta$  /  $\nabla$ .
- To confirm the selection, press **10** **Cursor**  $\triangleright$  or **10** **ENTER**.
- To return to the previous menu, press **10**  $\triangleleft$ .

**4** Press **10** **ENTER** to start play back.

You can also perform the following operations with remote control.

Key	Function
$\triangleright \triangleright$	Skip forward during playback
$\triangleleft \triangleleft$	Skip backward during playback
$\square$	Stop
$\triangleright$	Play

## Play information display

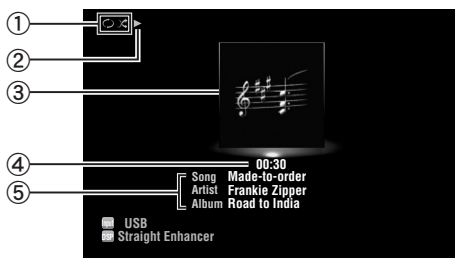

- Shuffle and repeat icons
- (playback)
- Album art (image of CD jacket, etc)
- Elapsed time
- Song title, artist name, album title



- Album arts are available only when the file contains image data.

## Shuffle/repeat playback

**1** Press **18** **OPTION** on the remote control while **"USB"** is selected as the input source. The Option menu for **"USB"** is displayed (page 37).

**2** Press **10** **Cursor**  $\Delta$  /  $\nabla$  to select **"Shuffle"** or **"Repeat"** and then press **10** **ENTER**.

**3** Press **10** **Cursor**  $\triangleleft$  /  $\triangleright$  to select the desired playback style.

### Shuffle:

- Select **"Off"** if you do not want to play back in random order.
- Select **"On"** to play back music files in random order.

### Repeat:

- Select **"Off"** if you do not want to play back repeatedly.
- Select **"One"** to repeat each music file.
- Select **"All"** to repeat all music files in the folder.



- When the shuffle function is on,  $\infty$  appears on the GUI screen.
- When **"Repeat"** is set to **"One"** or **"All"**,  $\infty$  or  $\infty$  appears on the GUI screen.

**4** To exit the Option menu, press **18** **OPTION**.

# Other functions

## Using the sleep timer

The sleep timer is useful if you want to go to sleep while this unit is playing or recording a source.

Press **[7] SLEEP** repeatedly to set the amount of time.

Each time you press **[7] SLEEP**, the front panel display changes as shown below.

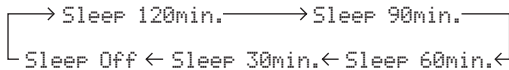

When the sleep timer is set, the SLEEP indicator on the front panel display lights up.

Press **[7] SLEEP** on the remote control repeatedly until “Sleep Off” appears on the front panel display.

## Using the HDMI™ control function

You can operate the following functions of this unit with the remote control of your TV when connecting this unit and the TV (HDMI control function supported) with HDMI.

- Turning on this unit or to the standby (conjunction with TV)
- Adjusting the volume
- Selecting a device to reproduce TV sounds (this unit or TV)

Please refer to the manual supplied with your TV and check the following.

- The HDMI control function is enabled on your TV.
- This unit is appropriately connected to your TV.



- The HDMI control-compatible components include Panasonic VIERA Link compatible TV, DVD player/recorder and Blu-ray Disc player.
- If you connect this unit and your DVD player, Blu-ray player or HD DVD player (HDMI control function supported) with HDMI, you can also control the device.
- We suggest that you use products (TV, DVD player, Blu-ray player or HD DVD player) from the same manufacturer.

### 1 Turn on all devices connected to this unit with HDMI.

For details, refer to the manual supplied with your device.

### 2 Enable the HDMI control function on each device.

For this unit, set “HDMI Control” to “On” (page 48). For external devices, refer to the manual supplied with each device to enable the HDMI control function.



- You do not need to perform steps 1 through 2 from the next time.

### 3 Turn off the TV.

Other HDMI control devices are also turned off in conjunction with the TV. If not, turn off them manually.

### 4 Turn on the TV.

Other HDMI control devices are also turned on in conjunction with the TV. If not, turn on them manually.

### 5 Select this unit as the input source of the TV.

### 6 Turn on the HDMI control device (DVD player or Blu-ray player) connected to this unit.

For this unit, check that the DVD player or Blu-ray player is selected as an input source of this unit. If not, select it as an input source.

For external devices, check that the TV screen shows the playback picture of the player.

### 7 Check if the HDMI control function works (turn on this unit or adjust the volume level using the remote control of the TV).

#### Note

- In case the HDMI control function does not work, check the followings. Also, turning off (unplug) and turning on (plug) the TV may be effective.
  - “HDMI Control” is set to “On” on this unit.
  - The HDMI control function is enabled on the TV.
-  This unit automatically selects the TV scene (page 23) when you select this unit as the device to reproduce TV sounds using the remote control of your TV. That is, if you connect an audio output jack of your TV to the AV 1 (OPTICAL) jack of this unit, you can enjoy TV sounds with the specified sound field program soon.

# ADVANCED OPERATION

## Setting the option menu for each input source (Option menu)

This unit has an Option menu of frequently used menu items for input sources compatible with this unit. The procedure for setting the Option menu items is described below.

**1** Rotate the **INPUT** selector (or press **Input selection key**) to select the desired input source.

**2** Press **OPTION** on the remote control. The Option menu for the selected input source is displayed. For details about the Option menu items of each input source, see “Option menu items” on this page.

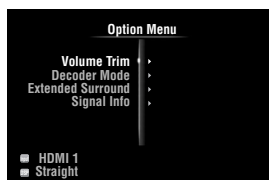

**3** Press **Cursor**  $\Delta$  /  $\nabla$  to select the desired menu item and then press **ENTER**. Parameters of the selected menu item are displayed.

**4** Press **Cursor**  $\Delta$  /  $\nabla$  /  $\triangleleft$  /  $\triangleright$  to select the desired setting and then press **ENTER**.

**5** To exit the Option menu, press **OPTION**. To return to the previous menu, press **RETURN**.

### Note

- In case **Cursor**  $\Delta$  /  $\nabla$  /  $\triangleleft$  /  $\triangleright$  or other keys do not work after closing the Option menu, press **Input selection key** to select the current input source again.

## Option menu items

The following menu items are provided for each input source.

Input Source	Menu item			
HDMI1-4	Volume Trim	Decoder Mode	Extended Surround	Signal Info
AV1-4	Volume Trim	Decoder Mode	Extended Surround	Signal Info
AV 5-6	Volume Trim			
AUDIO1/2	Volume Trim	Video Out		
V-AUX	Volume Trim			
PHONO	Volume Trim			
USB	Volume Trim	Signal Info	Shuffle	Repeat
iPod (DOCK)	Volume Trim	Shuffle	Repeat	
BLUETOOTH (DOCK)	Volume Trim	Connect/ Disconnect	Pairing	
TUNER	Volume Trim	FM Mode	Auto Preset	Clear Preset
MULTI CH	Volume Trim	Video Out		

Details of the menu items are as follows:



- The default settings are marked with “\*”.

### Volume Trim

**Input source:** All

**Adjustable range:** -6.0dB to 0.0dB\* to +6.0dB  
(in 0.5 dB steps)

Reduces any change in volume when switching input sources by correcting volume differences between input sources.

You can set this parameter for each input source.

## Decoder Mode

**Input source:** HDMI1-4, AV1-4

**Choices:** Auto\*, DTS

Selects DTS digital audio signals for reproduction.

- Auto Automatically selects audio input signals.
- DTS Selects DTS signals only. Other input signals are not reproduced.

## Extended Surround

**Input source:** HDMI1-4, AV1-4



**Choices:** Auto\*, PLIIXMovie, PLIIXMusic, EX/ES, Off

Selects whether to reproduce multi-channel input signals in 6.1- or 7.1-channel when surround back speakers are used.

- Auto Automatically selects the most suitable decoder according to whether a flag for reproducing surround back channel is present, and reproduces the signals in 6.1- or 7.1-channel.
- PLIIX Movie Always reproduces signals in 6.1- or 7.1-channel using the PLIIXMovie decoder whether or not surround back channel signals are contained. You can select this parameter when two surround back speakers are connected.
- PLIIX Music Always reproduces signals in 6.1- or 7.1-channel using the PLIIXMusic decoder whether or not surround back channel signals are contained. You can select this parameter when one or two surround back speakers are connected.
- EX/ES Automatically selects the most suitable decoder for input signals whether or not the flag for reproducing surround back channel is present, and always reproduces signals in 6.1-channel.
- Off Always reproduces original signals whether or not the flag for reproducing surround back channel is present.

## Signal Info

**Input source:** HDMI1-4, AV1-4, USB

Displays information on audio and video signals on the GUI screen and front panel display. You can change items to be displayed using  **Cursor**  / .

- Audio information

Format	Format of digital audio signals.
Channel	The number of input signal channels (front/surround/LFE). For example, if input signal channels are 3 front channels, 2 surrounds and LFE, "3/2/0.1" is displayed. If a channel that cannot be expressed as the above, a total number of channels such as "5.1ch" may be displayed.

Sampling Frequency	The sampling frequency per second in analog-to-digital conversion.
Bitrate	The bit rate of input signal per second.

## Notes

- "No Signal" is displayed when no signals are input and "---" is displayed when signals that this unit cannot recognize are input.
- The bit rate may vary during playback.

- Video information

Video In	Format and resolution of video input signal.
Video Out	Format and resolution of video output signal.
Message	Error messages about HDMI signals and HDMI components. See the following for details of the error messages.

- HDMI error message (appears only when an error has occurred)

HDCP Error	HDCP authentication failed.
Device Over	The number of HDMI components connected is over the limit.
Out of Res.	The connected monitor is not compatible with the video input signal.

## FM Mode

**Input source:** TUNER

**Choices:** Stereo\*, Mono

Sets FM broadcasting receiving mode.

- Stereo Receives in stereo mode.
- Mono Receives in monaural mode. You can get a better reception in monaural mode.

## Auto Preset

**Input source:** TUNER

Automatically detects FM radio stations and registers them as preset stations (page 30).

## Clear Preset

**Input source:** TUNER

Clears preset station (page 31).

## Shuffle

**Input source:** iPod (DOCK), USB

**Choices:** iPod (DOCK): Off\*, Songs, Albums  
USB: Off\*, On

Changes the shuffle playback style.

## Repeat

**Input source:** iPod (DOCK), USB

**Choices:** Off\*, One, All

Changes the repeat playback style.



**Connect / Disconnect****Input source:** BLUETOOTH (DOCK)

Connects to or disconnects from a Bluetooth component.

**Pairing****Input source:** BLUETOOTH (DOCK)

Performs pairing of this unit and a Bluetooth component (page 34).

**Video Out****Input source:** AUDIO 1/2, MULTI CH**Choices:** AV1 to AV6, V-AUX, Off\*

Specifies a video signal to be output during an audio reproduction. For details, see “Selecting a video signal to be output during an audio reproduction” on this page.

**Selecting a video signal to be output during an audio reproduction**

This function enables this unit to output video signals when “AUDIO 1”, “AUDIO 2” or “MULTI CH” is selected as the input source. Follow the procedure below to select the video to be output during an audio reproduction.

- 1** Rotate the **ⓇINPUT** selector (or press **ⓂInput selection key**) to select “AUDIO 1”, “AUDIO 2” or “MULTI CH” as the input source.
- 2** Press **ⓂOPTION** on the remote control.  
The Option menu for the selected input source is displayed.
- 3** Press **ⓂCursor** **△ / ▽** to select “Video Out” and then press **ⓂENTER**.

The screenshot shows a monochrome LCD display with two lines of text. The top line reads 'MLT CH' and the bottom line reads 'Video: .....Off\*'. The text is centered and uses a simple dot-matrix font.

- 4** Press **ⓂCursor** **< / >** to select a video input jack to be used during an audio reproduction.
  - AV1-2 (COMPONENT VIDEO)
  - AV3-6 (VIDEO)
  - V-AUX (VIDEO)
  - Off (no video output)
- 5** To exit the Option menu, press **ⓂOPTION**.

# Editing surround decoders/sound field programs

## Setting sound field parameters

Although the field sound programs would satisfy you as they are with the default parameters, you can arrange sound effect or decoders suitable for acoustical conditions of sources or rooms by setting the parameters.



- You cannot configure the parameters when “Memory Guard” is set to “On” (page 50).

- Turn on the video monitor connected to this unit.
- Press **[9] ON SCREEN** on the remote control. The GUI screen appears on the video monitor.
- Press **[10] Cursor**  $\nabla$  to select “Setup” and then press **[10] ENTER**.
- Press **[10] Cursor**  $\Delta$  /  $\nabla$  to select “DSP Parameter” and then press **[10] ENTER**.

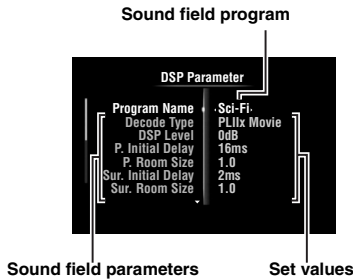

- Press **[10] Cursor**  $\Delta$  /  $\nabla$  to select “Program Name” and then press **[10] Cursor**  $\triangleleft$  /  $\triangleright$  to select a sound field program to edit.
- Press **[10] Cursor**  $\Delta$  /  $\nabla$  to select a parameter to edit and then press **[10] Cursor**  $\triangleleft$  /  $\triangleright$  to change the setting.

For details on functions and adjustable ranges of the sound field parameters, see “Sound field parameters” on this page.



- Repeat steps 5 and 6 to change other sound field program parameters.

- To turn off the GUI screen, press **[9] ON SCREEN**.

To initialize the parameters of the selected sound field program, press **[10] Cursor**  $\nabla$  repeatedly to select “Initialize” and then press **[10] Cursor**  $\triangleright$ . Then, press **[10] Cursor**  $\triangleright$  again to execute the initialization or **[10] Cursor**  $\triangleleft$  to cancel it.

## Sound field parameters



- The default settings are marked with “\*”.

### CINEMA DSP basic parameters

#### DSP Level

**Adjustable range:** -6dB to 0dB\* to +3dB

Fine adjusts an effect level (level of the sound field effect to be added). You can adjust the level of the sound field effect while checking sound levels. Adjust “DSP Level” as follows.

- The effect sound is too soft.
  - There are no differences between effects of the sound field programs.
    - Increase the effect level.
- The sound is dull.
  - The sound field effect is added too much.
    - Reduce the effect level.

#### Dialogue Lift

**Choices:** 0\* to 5

Use this feature to adjust the vertical position of the dialogues in movies. The ideal position of the dialogues is at the center of the video monitor screen.

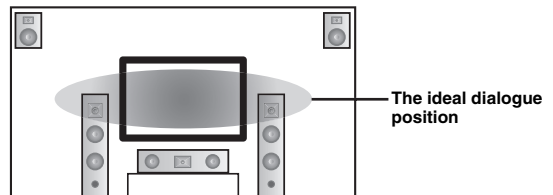

If the dialogues are heard at the lower position of the video monitor screen, increase the value of “Dialogue Lift”.

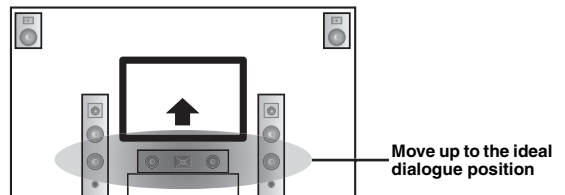

When the value is set to zero, the position is at the lowest. The position gets higher as you increase the value.

#### Notes

- This setting is available only when “Extra Speaker Assignment” is set to “Presence” (page 46).
- You cannot move the dialogue position down from the initial dialogue position.

#### 3D DSP

**Choices:** On\*, Off

When CINEMA DSP 3D is enabled, sets whether to use sound field programs in 3D mode.

**Note**

- This setting is available only when “Extra Speaker Assignment” is set to “Presence” (page 46).

**Sound field parameters for advanced configurations**

**Parameters for adjusting early-reflected sound**

**Initial Delay / P. Initial Delay / Sur. Initial Delay / Sur. Back Initial Delay**

**Adjustable range:** 1 to 99ms (Initial Delay / P. Initial Delay), 1 to 49ms (Sur. Initial Delay / Sur. Back Initial Delay)

Adjusts attenuation characteristics of early-reflected sound. You can create a lively sound field (with a high reverberant sound level) as you increase the value, and a dead sound field (with a low reverberant sound level) as you decrease the value. Creating either a lively sound field or a dead sound field in an actual music hall is determined by the acoustic absorption characteristics of reflection surfaces. A dead sound field is created when the attenuation time is short while a lively sound field is created when the attenuation time is long.

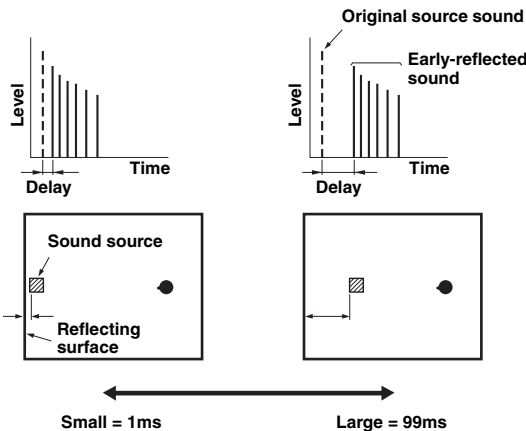

- We recommended that you adjust the size of corresponding sound field when you adjust the delay time.

**Parameters for specifying room size**

**Room Size / P. Room Size / Sur. Room Size / Sur. Back Room Size**

**Adjustable range:** 0.1 to 2.0

Produces different senses of sound expansion according to room sizes specified. In a large size room such as a music hall, the duration from when reflected sound is heard until when the next reflected sound is heard is long. Thus, different senses of sound expansion can be created by changing the duration. 1.0 is the original room size. When this parameter is set to 2.0, each side of the room is defined as twice larger than the original room size.

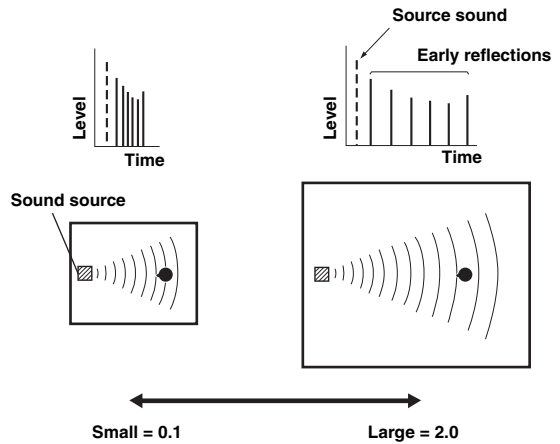

**Parameters for defining attenuation characteristics of early-reflected sound**

**Liveness / Sur. Liveness / Sur. Back Liveness**

**Adjustable range:** 0 to 10

Adjusts the attenuation of reflected sound. You can create a lively sound field (with a high reverberant sound level) as you increase the value, and a dead sound field (with a low reverberant sound level) as you decrease the value. Creating either a lively sound field or a dead sound field in an actual music hall is determined by the acoustic absorption characteristics of reflection surfaces. A dead sound field is created when the attenuation time is short while a lively sound field is created when the attenuation time is long.

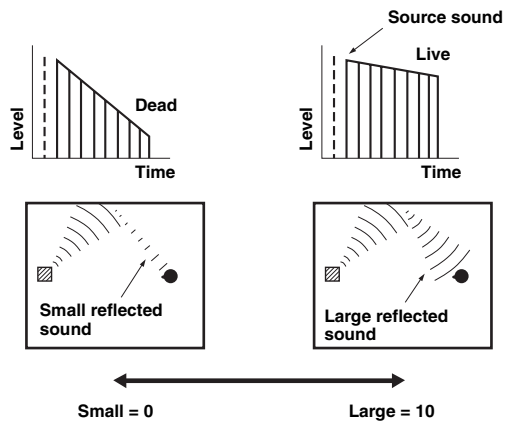

**Parameters for adjusting reverberant sound**

**Reverb Time**

**Adjustable range:** 1.0 to 5.0s

Reverb Time parameter adjusts the attenuation time of the rear reverberant sound based on the time that about 1kHz reverberant sound takes for 60dB of attenuation.

Reverberant sound attenuates faster as you decrease the value. Reverb Time adjustment allows you to create a natural reverberant sound, by setting the attenuation time longer for a sound source or room with less echo, or shorter for a sound source or room with more echo.

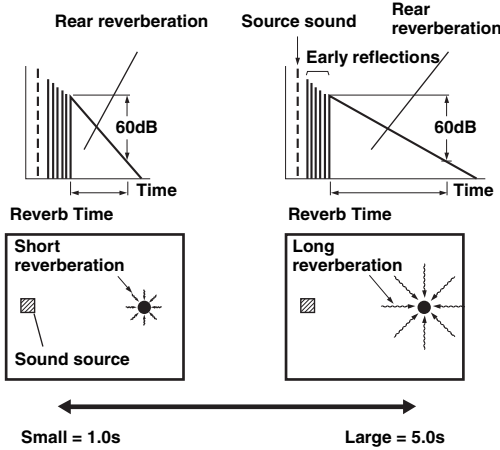

**Reverb Delay**

**Adjustable range:** 0 to 250ms

Reverb Delay parameter adjusts the time difference between the beginning of the direct sound and the beginning of the reverberation sound. The larger the value, the later the reverberation sound begins. Increasing the value of Reverb Delay allows you to create a reverberant sound in a wider area for the same Reverb Time.

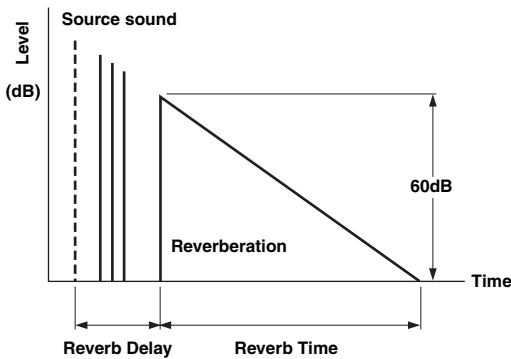

**Reverb Level**

**Adjustable range:** 0 to 100%

Reverb Level parameter adjusts the reverberation sound level. Increasing the value of Reverb Level makes the reverberation sound level higher, which allows you to create more echo.

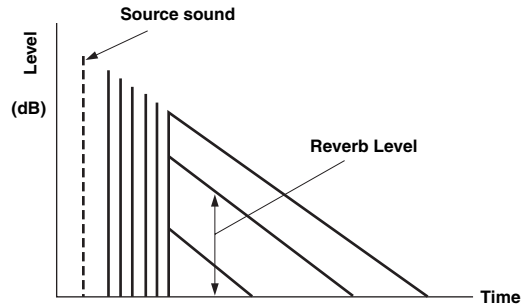

**Parameters for certain sound field programs**

**Parameter for MOVIE sound field programs**

**Decode Type**

**Choices:** PLIIx Movie (PLII Movie), Neo:6 Cinema

Selects the decoder type for use with the MOVIE sound field programs.

**Note**

- You cannot select a decoder for the following MOVIE sound field programs.
  - Mono Movie
  - Sports
  - Action Game
  - Roleplaying Game

**Parameter for 2ch Stereo**

**Direct**

**Choices:** Auto\*, Off

Automatically bypasses the DSP circuit and tone control circuit when an analog sound source is selected as the input source. You can enjoy a higher quality sound.

**Auto** Outputs sound by bypassing the DSP circuit and tone control circuit when the “Bass” and “Treble” tone controls are both set to 0 dB.

**Off** Do not bypass the DSP circuit and tone control.

**Parameters for 7ch Stereo**

**Center Level / Surround L Level / Surround R Level / Surround Back Level / Presence L Level / Presence R Level**

**Adjustable range:** 0 to 100%

Adjusts the volume of the center, surround L/R, surround back and presence L/R channels in the 7ch Stereo program. The available parameters differ depending on the setting of the speakers.

## ■ Parameter for Straight Enhancer and 7ch Enhancer

### Effect Level

**Choices:** High\*, Low

Adjusts the Compressed Music Enhancer effect level. When the high-frequency signals of the source is emphasized too much, set the effect level to “Low”. To reduce the effect, set this parameter to “Low”.

### Decoder parameters

You can customize decoder effects by setting the following parameters. For details about the types of decoders, see “Surround decode mode” (page 28).

## ■ Parameter for PLIIX Music and PLII Music

### Panorama

**Choices:** Off\*, On

Adjusts the soundscape of the front sound field. Sends stereo signals to the surround speakers as well as the front speakers for a wraparound effect.

### Dimension

**Adjustable range:** -3 to STD\* to +3

Adjusts the difference in level between the front sound field and the surround sound field. You can adjust the difference in level created by the software being played back to obtain the preferred sound balance. The surround sound gets stronger as you make the value more negative and the front sound gets stronger as you make the value more positive.

### Center Width

**Adjustable range:** 0 to 3\* to 7

You can spread the center sound toward left and right according to your preference. Set this parameter to 0 for outputting the center sound from the center speaker only, or to 7 for outputting it from the front left/right speaker.

## ■ Parameter for Neo:6 Music

### Center Image

**Adjustable range:** 0.0 to 0.3\* to 1.0

Adjusts the front left and right channel output relative to the center channel to make the center channel more or less dominant as necessary.

# Operating various settings for this unit (Setup menu)

You can call the Setup menu using the remote control and change the settings of various menus. For details, read “Basic operation of the Setup menu” first, and see the respective pages.

Menu/Submenu	Function	Page
Speaker Setup	Sets items for speakers.	45
Auto Setup (YPAO)	Automatically adjusts output characteristics of speakers.	45
Manual Setup	Manually adjusts output characteristics of speakers.	45
Speaker Configuration	Sets speaker configurations, such as connection status of speaker and a size of the connected speaker (sound reproduction capacity), suitable for the listening environment.	45
Speaker Level	Separately adjusts volume of each speaker.	47
Speaker Distance	Adjusts timing at which each speaker outputs sound based on distances between speakers and the listening position.	47
Equalizer	Selects an equalizer that adjusts speaker output characteristics.	47
Test Tone	Generates test tones.	47
Sound Setup	Sets various items for sound outputs.	47
Dynamic Range	Adjusts dynamic ranges of speakers and headphones.	47
Lipsync	Adjusts delay in output timing between video signals and audio signals.	48
HDMI Auto Lipsync	Sets on or off of automatic adjustments for delay between output timing between video signals input from the HDMI jack and audio signals.	48
Auto Delay	Fine adjusts a delay time of HDMI Auto.	48
Manual Delay	Manually fine adjusts the delay of audio and visual output.	48
Function Setup	Sets various items for HDMI and display.	48
HDMI	Sets various items for input sources.	48
HDMI Control	Selects on or off of the HDMI control function when a component that supports the HDMI control function is connected with this unit.	48
Standby Through	Selects on or off of output of HDMI signals input from the HDMI 1-4 jacks to the HDMI OUT jack when this unit is on standby.	48
Audio Output	Selects this unit or a component connected to the HDMI OUT jack of this unit for reproducing sound signals.	48
Resolution	Sets resolution of the HDMI output that is converted from analogy visual input signals.	48
Aspect	Set an aspect ratio of images reproduced by HDMI signals converted from analog video input signals.	49
Display	Sets items for a video monitor or the front panel display.	49
Dimmer	Sets brightness of the front panel display.	49
Front Panel Display Scroll	Selects the way to display characters on the front panel display.	49
GUI Position	Adjusts top and bottom positions of the GUI screen displayed on the video monitor.	49
Volume	Sets items for volumes.	49
Adaptive DRC	Adjusts the dynamic range (difference between the maximum volume and the minimum volume) in conjunction with the volume level.	49
Max Volume	Sets the maximum volume level so that the volume will not be accidentally increased.	49
Initial Volume	Sets the volume at the time this unit is turned on.	49
Input Rename	Changes input source names to be displayed on the GUI screen or the front panel display.	50
Zone2	Sets the maximum volume level and initial volume level of Zone2.	50
Zone2 Max Volume	Sets the maximum volume level so that the volume will not be accidentally increased.	50
Zone2 Initial Volume	Sets the volume at the time this unit is turned on.	50

Menu/Submenu	Function	Page
DSP Parameter	Sets parameters for the sound field programs.	50
Memory Guard	Protects some settings against accidental alteration.	50

## Basic operation of the Setup menu

The Setup menu screen appears on both the GUI screen and front panel display.

GUI screen

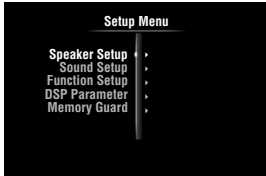

Front panel display



In this section, procedures of setting menus using the video monitor are described.

**1 Press [ON SCREEN] on the remote control.**  
The GUI screen appears on the video monitor.

**2 Press [Cursor] to select "Setup" and then press [ENTER].**  
The Setup menu appears on the video monitor.

**3 Press [Cursor] to select the desired menu then press [ENTER].**  
Items of the selected menu are displayed.

Example (Function Setup)

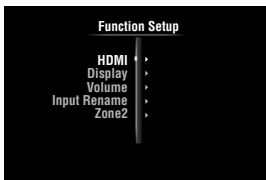

To return to the previous menu, press [RETURN].

**4 If necessary, press [Cursor] to select the desired submenu then press [ENTER].**

Example (Volume)

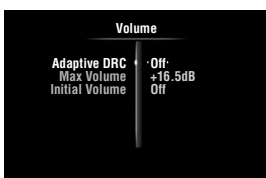

**5 Press [Cursor] to select an item to edit and then press [Cursor] to change the setting.**

Some items in "Manual Setup" or "Speaker Setup" take up a full screen. To display other items in "Manual Setup", press [Cursor].

Example (Speaker Configuration)

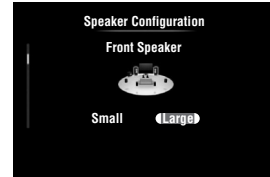

To configure other items, repeat step 5.

**6 To turn off the GUI screen, press [ON SCREEN].**

### Note

In case [Cursor] or other keys do not work after closing the Option menu, press [Input selection key] to select the current input source again.

## Speaker Setup

You can set various items for speakers. Two kinds of adjustments are available. One is "Auto Setup" (YPAO) for automatic adjustment and another is "Manual Setup" for manual adjustment.

The default settings are marked with "\*".

### Auto Setup

Automatically adjusts output characteristics of speakers to obtain optimum balance for the output sound based on positions and performances of the speakers and acoustic characteristics or the room, which are automatically measured. For details on operations, see page 20.

### Manual Setup

Adjusts output characteristics of speakers based on manually set parameters.

After "Auto Setup" (YPAO) is performed, you can check automatically adjusted parameters in the "Manual Setup" menu. Fine adjust the parameters for your preference if necessary.

### Speaker Configuration

Sets speaker configurations, such as connection status of speaker and a size of the connected speaker (sound reproduction capacity), suitable for the listening environment.



- The speaker configuration includes items for defining a speaker size: “Large” or “Small”. “Large” and “Small” refer to speakers with woofer diameters 16 cm or larger and smaller than 16 cm, respectively.

### Extra Speaker Assignment

**Choices:** Zone2\*, Presence, None

Selects the application for the EXTRA SP terminals.

- Zone2 Assigns the EXTRA SP terminals for the speakers in the second zone.
- Presence Assigns the EXTRA SP terminals for the presence speakers.
- None Disables the EXTRA SP terminals.

#### Note

- When setting “Extra SP Assign” to “Zone2” or “Presence”, the surround back channel signals for main output is separately output from other channels.

### LFE / Bass Out

**Choices:** Subwoofer, Front, Both\*

Selects speaker(s) for outputting low-frequency components of the LFE (low-frequency effect sound) channel or other channels. The output status is as follows.

LFE channel signals

Parameter	Subwoofer	Front speakers	Other speakers
Subwoofer	Output	Not output	Not output
Front	Not output	Output	Not output
Both	Output	Not output	Not output

Low-frequency components of other channel signals

Parameter	Subwoofer	Front speakers	Other speakers
Subwoofer	[1]	[2]	[2]
Front	Not output	[3]	[2]
Both	[3]	[4]	[2]

- [1] Outputs low-frequency components of the channel of speaker, the size of which is set to “Small”.
- [2] Outputs low-frequency components when the sizes of speakers are set to “Large”.
- [3] Outputs low-frequency components of the front left and right channels and the channel of speaker, the size of which is set to “Small”.
- [4] Outputs low-frequency components of the front left and right channels.

### Front Speaker

**Choices:** Small, Large\*

Sets the sizes of front left and right speakers.

- Small Select this when small speakers are connected. Low-frequency components of the front left and right channels are output from a subwoofer.
- Large Select this when large speakers are connected.

#### Note

- If “LFE / Bass Out” is set to “Front”, “Front Speaker” automatically switches to “Large” even when it is set to “Small”.

### Center Speaker

**Choices:** None, Small\*, Large

Sets the size of center speaker.

- None Select this when no center speaker is connected. Center channel signals are spread to front left and right speakers.
- Small Select this when a small center speaker is connected. Low-frequency components of center channel are output from a subwoofer. If a subwoofer is not connected they are output from front speakers.
- Large Select this when a large center speaker is connected.

### Surround Speaker

**Choices:** None, Small\*, Large

Sets sizes of left and right surround speakers.

- None Select this when no surround speakers are connected. Surround channel signals are spread to front left and right speakers. “Surround Back Speaker” automatically switches to “None” when this is selected.
- Small Select this when small surround speakers are connected. Low-frequency components of surround channels are output from a subwoofer. If a subwoofer is not connected they are output from front speakers.
- Large Select this when large surround speakers are connected.



- When “None” is selected, the sound field programs automatically enter the Virtual CINEMA DSP mode.

### Surround Back Speaker

**Choices:** None, Large x 1, Small x 1, Large x 2, Small x 2\*

Sets sizes of left and right surround back speakers.

- None Select this when no surround back speaker are connected. Surround back channel signals are output from the surround L/R speakers and subwoofer. If the subwoofer is disabled, they are output from the surround L/R speakers and front speakers.
- Large x 1 Select this when one large surround back speaker is connected.
- Small x 1 Select this when one small surround back speaker is connected.
- Large x 2 Select this when two large surround back speakers are connected.
- Small x 2 Select this when two small surround back speakers are connected.



- When “Surround Back Speaker” is set to “None”, “PLIIx Movie”, “PLIIx Music” and “PLIIx Game” of the surround decode mode (page 28) are not available.



### Bass Crossover Frequency

**Choices:** 40Hz, 60Hz, 80Hz\*, 90Hz, 100Hz, 110Hz, 120Hz, 160Hz, 200Hz

Sets the lower limit of the low-frequency component output from a speaker with a size set to “Small” (Small x 1, Small x 2) Sound with a frequency below that limit is output from a subwoofer or front speakers.

If your subwoofer has a volume control or a crossover frequency control, set the volume to half or the crossover frequency at the maximum.

### Subwoofer Phase

**Choices:** Normal\*, Reverse

Sets the phase of your subwoofer if bass sounds are lacking or unclear.

- Normal Select this not to change the phase of your subwoofer.
- Reverse Select this to reverse the phase of your subwoofer.

### Speaker Level

**Adjustable range:** -10.0dB to +10.0dB (0.5dB step)

**Defaults:** 0dB (FR.L, FR.R, SWFR, PR.L, PR.R)  
-1.0dB (CNTR, SUR.L, SUR.R, SBL, SBR)

Separately adjusts volume of each speaker so that the sounds from speakers are at the same volume at the listening position. Items to be displayed vary depending on the number of speakers connected.



- When only one surround back speaker is connected, “SB” appears instead of “SBL” and “SBR”.
- You can adjust the volume listening to test tones when you set “Test Tone” to “On” (on this page).
- If your subwoofer has a volume control or a crossover frequency control, set the volume to half or the crossover frequency at the maximum.

### Speaker Distance

Adjusts timing at which each speaker outputs sound so that sounds from speakers reach the listening position at the same time. Set unit (Unit) first and set the distance of each speaker.

### Unit

**Choices:** meters (m)\*, feet (ft)

- meters (m) Displays the speaker distance in meters.
- feet (ft) Displays the speaker distance in feet.

### FR.L / FR.R / CNTR / SUR.L / SUR.R / SBL / SBR / SWFR / PR.L / PR.R

**Adjustable range:** 0.30m to 24.00m (1.0ft to 80.0ft)

**Defaults:** 3.00m (10.0ft) (FR.L, FR.R, SWFR, PR.L, PR.R)  
2.60m (8.5ft) (CNTR)  
2.40m (8.0ft) (SUR.L, SUR.R, SBL, SBR)



- Available items differ depending on the “Speaker Configuration” settings (page 45).
- When only one surround back speaker is connected, “SB” appears instead of “SBL” and “SBR”.

### Equalizer

Adjusts sound quality and tone using a parametric graphic equalizer.

### EQ Type Select

**Choices:** Auto PEQ, GEQ\*, Off

Selects an equalizer type.

Auto PEQ Uses a parametric equalizer selected in “Auto Setup”. Characteristics of the currently used parametric equalizer are displayed below “Auto PEQ”.

GEQ Uses a graphic equalizer. Press **[10]ENTER** to adjust the characteristics of the graphic equalizer.

Off Not use a graphic equalizer.

### GEQ

**Channels** Front Left, Front Right, Center, Surround Left, Surround Right, Surround Back Left, Surround Back Right

**Choices:** 63Hz, 160Hz, 400Hz, 1kHz, 2.5kHz, 6.3kHz, 16kHz

**Adjustable range:** -6.0dB to 0dB\* to +6.0dB (0.5dB step)

Adjusts sound quality of each speaker using a graphic equalizer. The graphic equalizer of this unit can adjust signal levels in 7 frequency ranges.

To adjust the signal level within each range, press **[10]Cursor </>** to select the desired speaker while “Channel” is selected, press **[10]Cursor Δ / ▽** to select the desired frequency band and then press **[10]Cursor </>** to adjust the signal level.

### Test Tone

**Choices:** Off\*, On

Switches between on and off of an oscillator that generates test tones. When “On” is selected, you can adjust the settings of “Manual Setup” while listening to a test tone.

Off Not generate test tones.

On Generates test tones.

## Sound Setup

You can set various items for sound outputs.

### Dynamic Range

**Choices:** Min/Auto, STD, Max\*

Selects the dynamic range adjustment method for reproducing bitstream signals.

Min/Auto (Min) Sets the dynamic range suitable for low volume or a quiet environment, such as at night, for bitstream signals except for Dolby TrueHD signals.

(Auto) Adjusts the dynamic range for Dolby TrueHD signals based on input signal information.

STD Sets the standard dynamic range recommended for regular home use.

Max Outputs sound without adjusting the dynamic range of the input signals.

### ■ Lipsync

Adjusts delay between video output and audio output.

#### HDMI Auto Lipsync

**Choices:** Off\*, On

Automatically adjusts output timing of audio and video signals when a TV that supports an automatic lip-sync function is connected to this unit.

Off Select this when the connected TV does not support the automatic lip-sync function or you do not use the automatic lip-sync function. Set the correction time in “Manual Delay”.

On Select this when the connected TV supports the automatic lip-sync function. Fine adjust the correction time in “Auto Delay”.

#### Auto Delay

**Adjustable range:** 0\* to 240ms (1 ms step)

Fine adjust the correction time when “HDMI Auto Lipsync” is set to “On”. The actual correction time is displayed under in “Auto Delay” field and an offset time set by the user in “Offset” field.

#### Manual Delay

**Adjustable range:** 0\* to 240ms (1 ms step)

Manually fine adjusts the correction time. Select this when the connected TV does not support the automatic lipsync function or you set “HDMI Auto Lipsync” to “Off”.

## Function Setup

You can set various items for HDMI and display.

### HDMI

You can set items for HDMI.

#### ■ HDMI Control

**Choices:** On, Off\*

Selects on or off of the HDMI control function when a component that supports the HDMI control function is connected with this unit. When this parameter is set to “On”, this unit output signals input from the HDMI 1-4 jacks to the video monitor even when this unit is on standby.

On Enables the HDMI control function.

Off Disables the HDMI control function.



- The **HDMI THROUGH** indicator lights up in the following cases while this unit is on standby.
  - when the HDMI control function is on
  - when the HDMI signal standby-through function is currently working
- When “HDMI Control” is set to “On”, this unit consumes 1 to 3 watts of power depending on a condition of an HDMI signal passing through this unit.

#### ■ Standby Through

**Choices:** On, Off\*

Selects on or off of output of HDMI signals input from the HDMI 1-4 jacks to the HDMI OUT jack when this unit is on standby. When this parameter is set to “On”, this unit output signals input from the HDMI 1-4 jacks to the video monitor even when this unit is on standby.

On Outputs the HDMI signals to the HDMI OUT jack.

Off Not output the HDMI signals to the HDMI OUT jack.



- This parameter is not available when “HDMI Control” is set to “On”.
- To enable HDMI signal standby-through output, any one of the input sources connected to the HDMI 1-4 jacks must be selected before switching to standby.
- When “Standby Through” is set to “On”, the **HDMI THROUGH** indicator lights up. In this state, this unit consumes up to 3 watts of power even on standby.

#### ■ Audio Output

**Choices:** Amplifier\*, TV, Amplifier + TV

Selects this unit or a component connected to the HDMI OUT jack of this unit for reproducing sound signals input from the HDMI 1-4 jacks.

Amplifier Outputs HDMI sound signals from the speakers connected to this unit.

TV Outputs HDMI sound signals from the speakers of a TV connected to this unit. Sound output from the speakers connected to this unit is muted.

Amplifier + TV Outputs HDMI sound signals from the speakers connected to this unit and the speakers of a TV connected to this unit.

#### Note

- Signal formats of audio and visual signals output from this unit to the TV vary depending on specifications of the monitor.



- This parameter is not available when “HDMI Control” is set to “On”.

#### ■ Resolution

**Choices:** Through\*, 480p(576p), 720p, 1080i, 1080p

Upscales the resolution of HDMI output that is converted from analog video input signals and output from the HDMI OUT jack.

#### Notes

- Resolution of the HDMI output converted from 720p or 1080i analog video signals cannot be upscaled.
- When a video monitor is connected to the HDMI OUT jack of this unit, this unit automatically detects a resolution that the monitor supports. An asterisk (\*) appears on the left of the detected resolution.
- If this unit cannot detect the resolution that the monitor supports, set “MON.CHK” in the advanced setup menu to “SKIP” (page 54) and try again.

## ■ Aspect

**Choices:** Through\*, 16:9, Smart Zoom

Sets a horizontal to vertical ratio (aspect ratio) of images reproduced by HDMI signals output from the HDMI OUT jack when the HDMI signals are converted from analog video input signals by a video conversion function.

- Through Outputs the video signals without changing the aspect ratio.
- 16:9 Outputs the video signals that displays 4:3 images on a 16:9 TV with black bands on the right and left sides of the TV screen.
- Smart Zoom Outputs the video signals that displays 4:3 images on a 16:9 TV by stretching right and left of images to fit on the TV screen.

### Notes

- You cannot change the aspect ratio of the screen when "Resolution" is set to "Through".
- This setting is not effective for inputs with the aspect ratio other than 4:3.
- You cannot obtain an effect of the aspect ratio when visual signals are input from the HDMI 1-4 jacks or when 720p, 1080i or 1080p signals are input.

## Display

You can set items for a video monitor and the front panel display.

### Dimmer

**Adjustable range:** -4 to 0\*

Sets brightness of the front panel display. As the value is lowered, the brightness of the front panel display is darkened.

### Note

- The brightness of display does not become bright in Pure Direct mode even if the value is increased.

### Front Panel Display Scroll

**Choices:** Continuous\*, Once

Selects the way to scroll the screen when a total number of characters exceed a display area of the front panel display.

- Continuous Repeatedly displays all characters by scrolling.
- Once Displays all characters by scrolling once, halts scrolling and then displays first 14 characters.

### GUI Position

**Adjustable range:** -5 to 0\* to +5

Adjusts the position of the GUI screen displayed on the video monitor. To move the screen up (or to the right), set this value larger. To move the screen down (or to the left), set this value smaller.

## Volume

You can set items for volumes.

### ■ Adaptive DRC

**Choices:** Auto, Off\*

Adjust the dynamic range in conjunction with the volume level. This feature is useful when you are listening at lower volumes or at night. When this function is enabled, the dynamic range is adjusted as follows.

- When the volume level is low: narrow the dynamic range
- When the volume level is high: widen the dynamic range

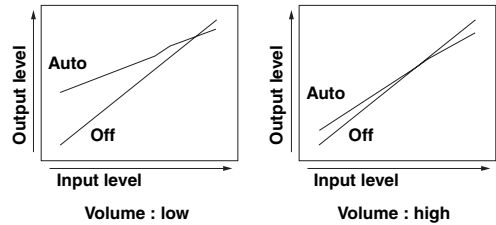

- Auto Adjusts the dynamic range automatically.
- Off Not adjust the dynamic range automatically.



- This setting is also effective for headphones.

### ■ Max Volume

**Adjustable range:** -30.0dB to +15.0dB, +16.5dB\* (5.0 dB step)

Sets the maximum volume level so that the volume will not be accidentally increased. For example, you can adjust the volume between -80.0 dB and -5.0 dB (or Mute) when you set this parameter to "-5.0dB". The volume increases to the maximum level when this parameter is set to +16.5 dB (default).

### ■ Initial Volume

**Adjustable range:** Off\*, Mute, -80.0dB to +16.5dB (0.5 dB step)

Sets the volume at the time this unit is turned on. When this parameter is set to "Off", the volume level used when this unit was set to standby is applied.

### Note

- When you set "Max Volume" and "Initial Volume" the setting of "Max Volume" becomes effective. For example, when you set "Max Volume" to "-30.0dB" and "Init. Volume" to "0.0dB", the volume is automatically set to "-30.0dB" at the next time this unit is turned on.

## Input Rename

Changes input source names to be displayed on the front panel display.

### Selecting a name to be displayed from templates

Press **[10]Cursor**  $\Delta$  /  $\nabla$  to select the input source name to edit and then press **[10]Cursor**  $\triangleleft$  /  $\triangleright$  to select a new name from the following templates.

- Blu-ray	- Satellite
- DVD	- VCR
- SetTopBox	- Tape
- Game	- MD
- TV	- PC
- DVR	- iPod
- CD	- HD DVD
- CD-R	- "blank"

### Entering an original name

Press **[10]Cursor**  $\Delta$  /  $\nabla$  to select the input source name to edit and then press **[10]ENTER**. Enter up to 9 characters by selecting one character at a time with the following key operations.

<b>[10]Cursor</b> $\triangleleft$ / $\triangleright$	Selects a character to edit.
<b>[10]Cursor</b> $\Delta$ / $\nabla$	Selects a character to enter.
<b>[10]ENTER</b>	Enters a selected character.

The following characters are available for input.  
A to Z, 0 to 9, a to z, symbols (#, \*, -, +, etc.) and space

## Zone2

Sets the maximum volume level and initial volume level of Zone2.



- These parameters are available only when "Extra Speaker Assignment" is set to "Zone2" (page 46).

### ■ Zone2 Max Volume

**Adjustable range:** -30.0dB to +15.0dB, +16.5dB\* (5.0 dB step)

Sets the maximum volume level of Zone2, so that the volume will not be accidentally increased. For example, you can adjust the volume between -80.0 dB and -5.0 dB when you set this parameter to "-5.0dB".

### ■ Zone2 Initial Volume

**Adjustable range:** Off\*, Mute, -80.0dB to +16.5dB (0.5 dB step)

Use this feature to set the volume level of Zone2 when the power of Zone2 unit is turned on. When this parameter is set to "Off", the volume level used at the time when the Zone2 unit was set to standby is applied.

### Note

- If you set "Zone2 Max Volume" and "Zone2 Initial Volume", the setting of "Zone2 Max Volume" becomes effective. For example, if you set "Zone2 Max Volume" to "-30.0dB" and "Zone2 Initial Volume" to "0.0dB", the volume is automatically set to "-30.0dB" at the next time the Zone2 unit is turned on.

## DSP Parameter

You can set parameters for the sound field programs. For details, see page 40.

## Memory Guard

**Choices:** Off\*, On

Protects the Setup menu settings against accidental alteration.

Off	Not protect settings.
On	Protects the Setup menu settings (except for "Decode Type" in "DSP Parameter" and "Memory Guard").

### Note

- When this parameter is switched to "On", "🔒" appears at the top left corner of the Setup menu screen.

# Using multi-zone configuration

This unit allows you to configure a multi-zone audio system. This feature allows you to set this unit to reproduce separate input sources in the main zone and the second zone (Zone2). You can control this unit from the second zone using the supplied remote control.

Only analog signal can be sent to the second zone. If you want to output sounds to Zone2, connect an external component to the AV5-6, AUDIO1-2 or VIDEO AUX (AUDIO) jacks (by analog connection). For example, if you want to output sound from an HDMI DVD player to the second zone, you must connect the HDMI DVD player to this unit by both HDMI and analog connections.

## Connecting Zone2

You need the following additional equipment to use the multi-zone functions of this unit:

- An infrared signal receiver in the second zone.
- An infrared signal emitter in the main zone. This emitter transmits infrared signals from the remote control to a CD player or a DVD player, etc. in the main zone via the infrared signal receiver in the second zone.
- An amplifier and speakers in the second zone.



- Since there are many possible ways to connect and use this unit in a multi-zone configuration, we recommend that you consult with your nearest authorized Yamaha dealer or service center about the Zone2 connections that best meet your requirements.
- Some Yamaha models can be directly connected to the REMOTE jacks of this unit. You may not need use an infrared signal emitter for these products. Up to 6 components can be connected using monaural analog mini cables or via an IR flashers. For details about connections, see “Transmitting/receiving remote control signals” (page 17).

## Using an external amplifier

Connect an amplifier/receiver in the second zone and other components to this unit as follows.

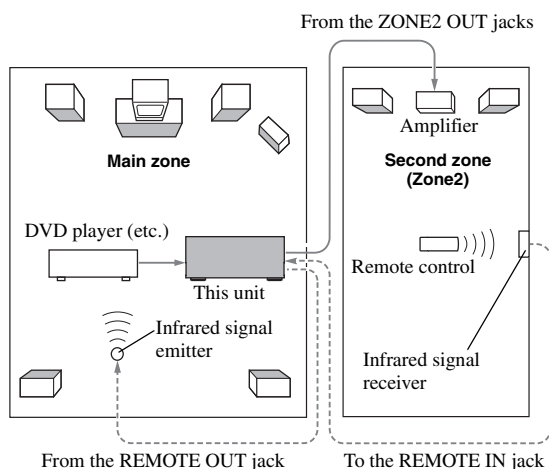

### Note

- To avoid unexpected noise, DO NOT USE the Zone2 feature with CDs encoded in DTS.

## Using the internal amplifier of this unit

### Important safety notice

The EXTRA SP terminals of this unit should not be connected to a Passive Loudspeaker Selector Box or more than one loudspeaker per channel. Connection to a Passive Loudspeaker Selector Box or multiple speakers per channel could create an abnormally low impedance load resulting in amplifier damage. See this owner's manual for correct usage. Compliance with minimum speaker impedance information for all channels must be maintained at all times. This information is found on the back panel of your unit.

Connect the speakers in the second zone to the EXTRA SP terminals and then set “Extra Speaker Assignment” to “Zone2” (page 46).

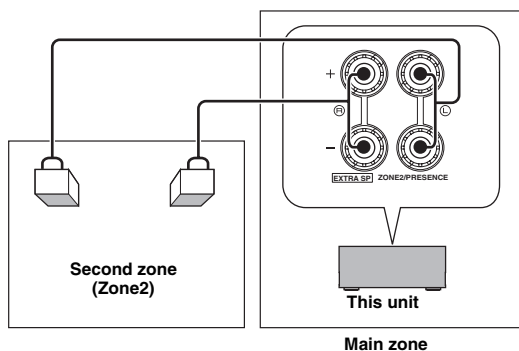

- You can use the speakers connected to EXTRA SP terminals as the front speaker system of another zone.
- When you use the internal amplifiers for the Zone2 speakers, you can adjust the volume level and set the initial volume and maximum volume of the Zone2 speakers (page 50).

## Controlling Zone2

You can select and control Zone2 by using the control keys on the front panel or on the remote control. The available operations are as follows:

- Selecting the input source.
- Tuning into the desired station (when “TUNER” is selected as the input source)
- Adjusting the volume of Zone2 (when Zone2 speakers are connected to the EXTRA SP terminals).

### Switching to the Zone2 operation mode

Before controlling Zone2 by using the control keys on the front panel or on the remote control, follow the procedure below to switch this unit to the Zone2 operation mode.

#### ■ To control Zone2 by using the front panel control keys

Press **Ⓢ** **ZONE2 CONTROL** while Zone2 is turned on.

The ZONE2 indicator flashes on the front panel display for approximately 10 seconds.

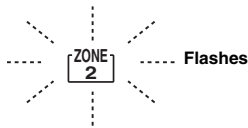

#### Note

- Complete each step while the ZONE2 indicator is flashing on the front panel display. Otherwise, the Zone2 mode is automatically canceled and this unit returns to the main zone operation mode.

#### ■ To control Zone2 by using the remote control

Switch **Ⓜ** **MAIN/ZONE2** to the “ZONE2” position.

### Operations in the Zone2 operation mode

#### ■ Turning on or set Zone2 to standby

Press **ⓐ** **ZONE2 ON/OFF** (or **Ⓟ** **POWER**).

#### ■ Operating Zone2

Rotate the **Ⓡ** **INPUT** selector (or press **Ⓛ** **Input selection key**) to select the desired input source.

- Select “AV5”, “AV6”, “AUDIO1”, “AUDIO2”, “V-AUX” or “PHONO” to listen to the input source in Zone2.
- Select “TUNER” to use the FM/AM radio features (page 30) in Zone2.
- Select “USB” to use the USB features (page 35) in Zone2.
- Select “DOCK” to use the iPod features (page 32) or Bluetooth features (page 34) in Zone2.

# Controlling other components with the remote control

You can control external components for a selected input source with the remote control. The keys available for controlling external components are as follows:

## 3 SOURCE POWER

Turns on and off an external component.

## 10 Cursor, ENTER, RETURN

Operates the menus of external components.

## 11 External component operation keys

Function as a recording or playback key of an external component, or a menu display key.

## 12 Numeric keys

Function as numeric keys of an external component.

## 13 TV control keys

**INPUT** Switches visual inputs of TV

**MUTE** Mutes audio of TV

**TV VOL +/-** Controls the volume of TV

**TV CH +/-** Switches channels of TV

**POWER** Turns on and off TV

## 20 DISPLAY

Switches between the screens of external components.



- You can use **13 TV control keys** only for controls of TV regardless of selected input sources.
- You need to set the remote control code first to control external components.
- The remote control keys for controlling external components are available only when the external components have corresponding control keys.

The following remote control codes are assigned to input sources as factory default settings. For a complete list of available remote control codes, refer to “List of remote control codes” at the end of this manual.

### ■ Default remote control code settings

Input source	Category	Manufacturer	Default code
[HDMI 1]	Blu-ray Disc	Yamaha	2018
[HDMI 2]	—	—	—
[HDMI 3]	—	—	—
[HDMI 4]	—	—	—
[AV 1]	—	—	—
[AV 2]	—	—	—
[AV 3]	CD	Yamaha	5013
[AV 4]	—	—	—
[AV 5]	—	—	—
[AV 6]	—	—	—
[AUDIO 1]	—	—	—
[AUDIO 2]	—	—	—
[V-AUX]	—	—	—
[PHONO]	—	—	—

Input source	Category	Manufacturer	Default code
[USB]	—	—	—
[DOCK]	DOCK	Yamaha	5011
[TUNER]	Tuner	Yamaha	5007
[MULTI]	—	—	—

“—” indicates no assignment



- An external component controlled by the remote control is automatically selected according to selection of the scenes (page 23).

## Setting remote control codes

You can control other components by setting the appropriate remote control codes. For a complete list of available remote control codes, refer to “List of remote control codes” at the end of this manual.

You should perform each step within 1 minute after the previous step.

**1 Press **15** CODE SET on the remote control using a pointed object such as the tip of a ballpoint pen.**

**14** TRANSMIT blinks twice.

**2 Press the desired **4** Input selection key.**

**3 Press **12** Numeric keys to enter a remote control code.**

Once the remote control code is registered,

**14** TRANSMIT blinks twice. If it fails,

**14** TRANSMIT blinks six times. Repeat from step 1.

## Resetting all remote control codes

You can reset all remote control codes to the factory default settings.

**1 Press **15** CODE SET on the remote control using a pointed object such as a tip of a ballpoint pen.**

**14** TRANSMIT blinks twice.

**2 Press **9** ON SCREEN.**

**3 Press **12** Numeric keys to enter “9981”.**

Once the initialization is complete, **14** TRANSMIT blinks twice. If it fails, **14** TRANSMIT blinks six times. Repeat from step 1.

# Advanced setup

In the advanced setup menu, you can set basic operations of this unit, such as on and off of a bi-amp connection, or initialize user settings.

## 1 Set this unit to standby.

## 2 While holding down **STRAIGHT** on the front panel, press **MAIN ZONE ON/OFF**.

Keep holding down **STRAIGHT** until "ADVANCED SETUP" appears on the front panel display.

ADVANCED SETUP

## 3 Rotate the **PROGRAM** selector to select the parameter you want to change.

The default setting are marked with "\*".



- Set values are placed in XXX of the following parameters on an actual display screen.

SP IMP. -XXX

**Choices:** 6ΩMIN, 8ΩMIN\*

Selects output impedance of this unit according to connected speakers. When you connect 4-ohm speakers to the FRONT speaker terminals, set "SP IMP:" to "6ΩMIN."

REMOTE ID -XXX

**Choices:** ID1\*, ID2

Sets a remote control ID. When using multiple Yamaha AV receivers, you can operate them with a single remote control by setting the receiver IDs to the same setting.

BI AMP - XXX

**Choices:** ON, OFF\*

Switches on and off of bi-amp connection of main speakers. For bi-amp connection, see page 12.

SCENE IR -XXX

**Choices:** ON\*, OFF

Selects whether or not to transmit the control signals to an external component connected to the REMOTE OUT jack on this unit when BD/DVD or CD SCENE function is selected.

MON. CHK - XXXX

**Choices:** YES\*, SKIP

Adds upscaling limitation on output signals to a video monitor connected to this unit via the HDMI OUT jack.

INIT-XXXXXXXXXX

**Choices:** DSP PARAM, VIDEO, ALL, CANCEL\*

Initializes various settings stored in this unit. You can select an initialization method from the following.

DSP PARAM All parameters of sound field programs

VIDEO Video conversion settings (resolution/aspect) in the Setup menu and the GUI display position

ALL All

CANCEL Cancellation of initialization

## 4 Press **STRAIGHT** repeatedly to change the selected parameter setting.

To change other settings, repeat steps 3 and 4.

## 5 Press **MAIN ZONE ON/OFF** to set this unit to standby.

The settings you made are reflected next time you turn on this unit.

### Updating the firmware

You can check the firmware of this unit and update the firmware using the USB port on the front panel. Select the following parameter in step 3 above.

FIRM UPDATE

Updates the firmware of this unit. To update the firmware, select "FIRM UPDATE" and then press **STRAIGHT**.

#### Notes

- Do not use this feature unless you need to update the firmware.
- Be sure to read information supplied with updates before updating the firmware.

VERXXX.XXX.XXX

Displays the firmware of this unit.

### Setting a remote control ID

Two IDs are provided for the remote control of this unit. If another Yamaha amplifier is in the same room, setting a different remote control ID to this unit prevents unwanted operation of the other amplifier.

"ID1" is set for both the main unit and remote control by default. If you have changed the remote control ID, make sure that you select the same ID for the main unit in the advanced setup menu.

## 1 Press **CODE SET** on the remote control using a pointed object such as the tip of a ballpoint pen.

**TRANSMIT** blinks twice.

## 2 Press **ON SCREEN**.



### 3 Enter the desired remote control ID code.

To switch to ID1:

Press **[12] Numeric keys** to enter “5019”.

To switch to ID2:

Press **[12] Numeric keys** to enter “5020”.

Once the remote control code is registered,

**[14] TRANSMIT** blinks twice.

If it fails, **[14] TRANSMIT** blinks six times. Repeat from step 1.



- If you initialize the settings of this unit, “REMOTE ID” (remote control code of this unit) is set to “ID1”.

# APPENDIX

## Troubleshooting

Refer to the table below when this unit does not function properly. If the problem you are experiencing is not listed below or if the instruction below does not help, turn off this unit, disconnect the power cable, and contact the nearest authorized Yamaha dealer or service center.

### General

Problem	Cause	Remedy	See page
<b>This unit does not operate properly.</b>	The internal microcomputer is frozen due to an external electric shock (such as lightning or excessive static electricity) or by a drop in power supply voltage.	Disconnect the power cable from the AC wall outlet, wait about 30 seconds and then plug it in again.	—
<b>This unit suddenly enters the standby mode</b>	The internal temperature is too high and the overheat protection circuitry has been activated.	Wait about 1 hour for this unit to cool down and then turn it back on.	—
	The protection circuitry has been activated because of a short circuit, etc.	Check that the speaker impedance setting is correct.	54
		Check that the speaker wires are not touching each other and then turn this unit back on.	—
	The sleep timer has turned off this unit.	Turn on this unit and play the source again.	—
<b>This unit fails to turn on or enters the standby mode soon after the power is turned on.</b>	The power cable is not connected or the plug is not completely inserted.	Connect the power cable properly to an AC wall outlet.	19
	The speaker impedance setting is incorrect.	Set the speaker impedance to match your speakers.	54
	(When this unit is turned back on and “CHECK SP WIRES!” is displayed.) The protection circuitry has been activated because this unit was turned on while a speaker cable was shorted.	Make sure that all speaker cables between this unit and speakers are connected properly.	11
<b>This unit cannot be turned off.</b>	The internal microcomputer is frozen due to an external electric shock (such as lightning or excessive static electricity) or by a drop in power supply voltage.	Disconnect the power cable from the AC wall outlet, wait about 30 seconds and then plug it in again.	—
<b>No picture.</b>	An appropriate video input is not selected on the video monitor.	Select an appropriate video input on the video monitor.	—
	The external video component is connected to one of the HDMI 1-4 jacks while your video monitor is connected to the MONITOR OUT (COMPONENT VIDEO or VIDEO) jacks.	Connect the external video component to the video input jacks other than the HDMI 1-4 jacks or connect the video monitor to the HDMI OUT jack.	14, 15
	This unit outputs the video signals not supported by the video monitor connected to the HDMI OUT jack.	Displays the advanced setup menu and select “VIDEO” in “INIT” to reset the video parameters.	54
		Displays the advanced setup menu and set “MON.CHK” to “YES”.	54
	Video signals are input from a game console while your video monitor is connected to the HDMI OUT jack.	Connect the video monitor to the MONITOR OUT (COMPONENT VIDEO) jacks.	14
Non-standard video signals are input.	Connect the video monitor to the MONITOR OUT (COMPONENT VIDEO or VIDEO) jacks.	14	

Problem	Cause	Remedy	See page
<b>The picture is disturbed.</b>	The video software is copy-protected.		
<b>No sound.</b>	Incorrect input or output cable connections.	Connect the cables properly. If the problem persists, the cables may be defective.	15
	No appropriate input source has been selected.	Rotate the <b>ⓇINPUT</b> selector (or press <b>4Input selection key</b> ) to select the desired input source.	23
	Speaker connections are not secure.	Secure the connections.	11
	The volume is turned down or muted.	Turn up the volume.	23
	Signals this unit cannot reproduce are being input from a source component, such as a CD-ROM.	Display "Signal Info" in the Option menu and check the input signal format. If "No Signal" is displayed, check if the playback component is properly connected to this unit (or a proper input source is selected). If "___" is displayed, the input signal in that format cannot be reproduced by this unit.	—
	The HDMI components connected to this unit do not support the HDCP copy protection standards.	Connect HDMI components that support the HDCP copy protection standards.	67
	"Audio Output" in "HDMI" is set to "TV".	Set "Audio Output" (Function Setup → HDMI → Audio Output) to the other setting.	48
	A proper audio decoder is not selected.	Display the Option menu and set "Decoder Mode" to "Auto".	37
<b>Only the center speaker outputs substantial sound.</b>	When a monaural source sound field program is applied, sound of all channels are output from the center speaker for some surround decoders.	Try another sound field program.	26
	The playback component or speakers are not connected properly.	Connect the cables properly. If the problem persists, the cables may be defective.	12, 15
<b>No sound is output from a specific speaker.</b>	Output from that speaker is disabled.	Check the Speaker indicators on the front panel display. If the corresponding indicator is turned off, try the following. 1) Change the input source to another one. 2) With the selected sound field program, sound is not output from that speaker. Select another sound field program. 3) "None" may have been selected for that speaker on this unit. Display "Speaker Setup" in the "Setup" menu and enables output of that speaker.	6, 23, 26, 45
	The volume of that speaker is set to minimum in "Speaker Setup" in the "Setup" menu.	Display "Speaker Setup" in the "Setup" menu and adjust the volume (Manual Setup → Speaker Level).	47
	This unit is in the straight decode mode.	Press <b>ⓄSTRAIGHT</b> (or <b>7STRAIGHT</b> ) to turn off the straight decode mode.	29
	Sound may not be output from certain channels depending on input sources or sound field programs.	Try another sound field program.	26
	The speaker is malfunction.	Check the speaker indicators on the front panel display. If the corresponding indicator lights up, connect another speaker and check if sound is output. If sound is not output, this unit may be malfunction.	—

<b>Problem</b>	<b>Cause</b>	<b>Remedy</b>	<b>See page</b>
<b>No sound is heard from the subwoofer.</b>	“LFE / Bass Out” is set to “Front” and a Dolby Digital, DTS or AAC signals is being played.	Set “LFE / Bass Out” to “Subwoofer” or “Both”.	46
	“LFE / Bass Out” is set to “Subwoofer” or “Front” and a 2-channel source is being played.	Set “LFE / Bass Out” to “Both”.	46
	The source does not contain low frequency signals.		
<b>No sound is heard from the surround back speakers.</b>	“Extended Surround” in the Option menu is set to “Off”, or an input signal does not contain a surround back flag with “Extended Surround” set to “Auto”.	Set “Extended Surround” other than “Off” or “Auto”.	38
<b>The audio input sources cannot be played in the desired digital audio signal format.</b>	The connected component is not set to output the desired digital audio signals.	Set the playback component properly referring to its operating instructions.	—
<b>Noise/hum noise is heard.</b>	Incorrect cable connection.	Connect the audio cables properly. If the problem persists, the cables may be defective.	—
	A DTS-CD is being played back.	1) When only noise is output If a DTS bitstream signal is not properly input to this unit, only noise is output. Connect the playback component to this unit by digital connection and play back the DTS-CD. If the condition is not improved, the problem may results from the playback component. Consult the manufacturer of the playback component. 2) When noise is output during playback or skip operation Before playing back the DTS-CD, display the Option menu after selecting the input source and set “Decoder Mode” to “DTS”.	15, 38
<b>The volume level cannot be increased, or the sound is distorted.</b>	The component connected to the AUDIO 1/2 jacks of this unit is turned off.	Turn on the power of the component.	53
<b>“Memory Guard!” is displayed and the setting cannot be changed.</b>	“Memory Guard” in “Set Menu” is set to “On”.	Set “Memory Guard” to “Off”.	50
<b>There is noise interference from digital or radio frequency equipment.</b>	This unit is too close to other digital or radio frequency equipment.	Move this unit further away from such equipment.	—

**HDMI™**

Problem	Cause	Remedy	See page
<b>No picture or sound.</b>	The number of the connected HDMI components is over the limit.	Disconnect some of the HDMI components.	—
	The connected HDMI component does not support high-bandwidth digital copyright protection (HDCP).	Connect an HDMI component that supports HDCP.	67

**Tuner (FM/AM)**

Problem	Cause	Remedy	See page
<b>FM stereo reception is noisy.</b>	You are too far from the station transmitter or the input from the antenna is weak.	Check the antenna connections.	18
		Replace the outdoor antenna with a more sensitive multi-element antenna.	—
		Switch to monaural mode.	38
<b>FM There is distortion, and clear reception cannot be obtained even with a good FM antenna.</b>	There is multi-path interference.	Adjust the antenna height or orientation, or place it in a different location.	—
<b>The desired station cannot be tuned into with the automatic tuning method.</b>	You are in an area far from a station or an input from the antenna is weak.	Replace an outdoor antenna with more sensitive multi element antenna.	—
		Tune in manually or by direct frequency tuning.	30
<b>The desired station cannot be tuned into with the automatic tuning method.</b>	The signal is weak or the antenna connections are loose.	Adjust the AM loop antenna orientation.	18
		Use the manual tuning method.	30
<b>AM There are continuous crackling and hissing noises.</b>	Supplied AM loop antenna is not connected.	Connect the AM loop antenna correctly even if you use an outdoor antenna.	18
	The noises may be caused by lightning, fluorescent lamps, motors, thermostats and other electrical equipment.	It is difficult to completely eliminate noise, but it can be reduced by installing and properly grounding an outdoor AM antenna.	18
<b>There are buzzing and whining noises.</b>	A TV set is being used nearby.	Move this unit away from the TV set.	—

## Remote control

Problem	Cause	Remedy	See page	
<b>The remote control does not work or function properly.</b>	Wrong distance or angle.	The remote control will function within a maximum range of 6 m (20 ft) and no more than 30 degrees offaxis from the front panel.	9	
	Direct sunlight or lighting (from an inverter type of fluorescent lamp, strobe light, etc.) is striking the remote control sensor of this unit.	Adjust the lighting angle or reposition this unit.	—	
	The batteries are weak.	Replace all batteries.	9	
	The remote control ID of the remote control and this unit do not match.	Match the remote control ID of this unit and the remote control.	54	
	The remote control code is not correctly set.		Set the remote control code correctly using “List of remote control codes” at the end of this manual.	53
			Try setting another code of the same manufacturer using “List of remote control codes” at the end of this manual.	53
		If this unit does not work when you press <b>Cursor</b> , do the following. When the key does not work during DVD disc menu operation: press the <b>Input selection keys</b> on the remote control again. When the key does not work during Option menu or Setup menu operation: press the key applicable for the current menu operation again.	—	
	Even if the remote control code is correctly set, there are some models that do not respond to the remote control.			

## iPod™

### Note

- In case of a transmission error without a status message appearing on the front panel display and GUI screen, check the connection of your iPod (page 17).

Status message	Cause	Remedy	See page
<b>Loading...</b>	This unit is in the middle of recognizing the connection with your iPod.		
	This unit is in the middle of acquiring song lists from your iPod.		
<b>Connect error</b>	There is a problem with the signal path from your iPod to this unit.	Turn off this unit and reconnect the Yamaha iPod universal dock to the DOCK terminal of this unit.	17
		Remove your iPod in the Yamaha iPod universal dock and then place it back in the dock.	32
<b>Unknown iPod</b>	The iPod being used is not supported by this unit.	Use an iPod supported by this unit.	—
<b>iPod Connected</b>	Your iPod is properly placed in the Yamaha iPod universal dock.		

Status message	Cause	Remedy	See page
<b>Disconnected</b>	Your iPod is removed from the Yamaha iPod universal dock.		32
<b>Unable to play</b>	This unit cannot play back the songs currently stored on your iPod.	Check that the songs currently stored on your iPod are playable.	—

## Bluetooth™

Status message	Cause	Remedy	See page		
<b>Searching...</b>	The Bluetooth wireless audio receiver and the Bluetooth component are in the middle of the pairing.				
	The Bluetooth wireless audio receiver and the Bluetooth component are in the middle of establishing the connection.				
<b>Completed</b>	The pairing is completed.				
<b>Canceled</b>	The pairing is canceled.				
<b>BT Connected</b>	The connection between the Yamaha Bluetooth wireless audio receiver and the Bluetooth component is established.				
<b>Disconnected</b>	The Bluetooth component is disconnected from the Yamaha Bluetooth wireless audio receiver.				
<b>Not Found</b>	No Bluetooth components are found during a pairing process.			Pairing must be performed on the both this unit and your Bluetooth component at the same time. Check whether your Bluetooth component is set to the pairing mode and then try again.	34
	No Bluetooth components are found during a Bluetooth connection.			Check whether your Bluetooth component is turned on and then try again.	34
				Locate your Bluetooth component within 10 meters (33 feet) of this unit and then try again.	34

## USB

Problem	Cause	Remedy	See page
<b>The music files and folder cannot be browsed.</b>	The music files and folders are stored the locations other than the FAT area.	Place the music files and folders in the FAT area.	—
	You are attempting to browse directory hierarchies of over 8 levels or a directory with more than 500 files.	Modify the data structure on your USB storage device.	—
	This unit cannot recognize some characters used in the file name or folder name.	Edit the file name or folder name using a PC and then try again.	—
<b>The USB storage device cannot be recognized.</b>	The USB storage device is not compatible with mass storage class (except USB HDDs).	Use a USB storage device that is compatible with mass storage class (except USB HDDs).	—
	This unit does not recognize the USB storage device properly.	Turn this unit off and then turn on again.	19

Status message	Cause	Remedy	See page
<b>USB Connected</b>	Your USB storage device is connected.		—
<b>Disconnected</b>	Your USB storage device has been disconnected from the USB port of this unit.	Check the connection between this unit and your USB storage device.	—
	This unit recognizes the USB storage device as an illegal device.	Turn this unit off and then turn on again.	19
<b>Access Error</b>	This unit cannot access your USB storage device.	Try another USB storage device.	—
	There is a problem with the signal path from your USB storage device to this unit.	Turn off this unit and reconnect your USB storage device to the USB port of this unit.	18, 19
		Try resetting your USB storage device.	—
<b>Unable to play</b>	The data is invalid.	Try another USB storage device.	—

## Auto Setup (YPAO)

### Notes

- If an error or warning message appears, resolve the problem and then run “Auto Setup” again.
- Warning message “W-2” or “W-3” indicates that the adjusted settings may not be optimal.
- Depending on the speakers, warning message “W-1” may appear even if the speaker connections are correct.
- If error message “E-10” occurs repeatedly, contact a qualified Yamaha service center.

### Before Auto Setup

Error message	Cause	Remedy	See page
<b>Connect MIC!</b>	Optimizer microphone is not connected.	Connect the supplied optimizer microphone to the OPTIMIZER MIC jack on the front panel.	20
<b>Unplug HP!</b>	Headphones are connected.	Unplug the headphones.	—
<b>Memory Guard!</b>	The parameters of this unit are protected.	Set “Memory Guard” to “Off”.	50

### During Auto Setup

Error message	Cause	Remedy	See page
<b>E-1:NO FRONT SP</b>	Front L/R channel signals are not detected.	Check the front L/R speaker connections.	11
<b>E-2:NO SUR. SP</b>	Only a signal from one of the surround channels are detected.	Check the surround L/R speaker connections.	11
<b>E-3:NO PRNS SP</b>	Only signals from one of the presence L/R channels are detected.	Check the presence L/R speaker connections.	11
<b>E-4:SBR-&gt;SBL</b>	Only right surround back channel signal is detected.	If you connect only one surround back speaker, connect it to the left SUR.BACK (SINGLE) jack.	11
<b>E-5:NOISY</b>	Measurement cannot be performed accurately due to loud ambient noise.	Try running “Auto Setup” in a quiet environment.	—
		Turn off noisy electric equipment like air conditioners or move them away from the optimizer microphone.	—
<b>E-6:CHECK SUR.</b>	Surround back speakers are connected, though surround L/R speakers are not.	When using surround back speakers, you need to connect surround L/R speakers.	11



Error message	Cause	Remedy	See page
<b>E-7:NO MIC</b>	The optimizer microphone was unplugged during the “Auto Setup” procedure.	Do not touch the optimizer microphone during “Auto Setup”.	20
<b>E-8:NO SIGNAL</b>	The optimizer microphone does not detect test tones.	Check whether the microphone is properly placed.	20
		Check whether the speakers are properly placed and connected.	10, 11
		The optimizer microphone or OPTIMIZER MIC jack may be defective. Contact the nearest Yamaha dealer or service center.	—
<b>E-9:USER CANCEL</b>	“Auto Setup” was canceled due to an inappropriate user operation.	Run “Auto Setup” again.	20
<b>E-10:INTERNAL ERROR</b>	An internal error occurred.	Run “Auto Setup” again.	20

### After Auto Setup

Error message	Cause	Remedy	See page
<b>W-1:OUT OF PHASE</b>	Speaker polarity is not correct. This message may appear depending on the speakers even when the speakers are connected correctly.	Check the polarities (+, -) of the displayed speaker. If they are correct, the speakers work properly even when this message is displayed.	12
<b>W-2:OVER 24m (80ft)</b>	The distance between the speaker and the listening position is over 24 m (80 ft).	Bring the speaker within 24 m (80 ft.) area around the listening position.	—
<b>W-3:LEVEL ERROR</b>	The difference of volume level among speakers is excessive.	Recheck the speaker positions and make sure all speakers are placed in a similar environment.	—
		Check the polarities (+, -) of the speakers.	12
		We recommended that you use speakers with the same or similar specifications.	—
		Adjust the output volume of the subwoofer.	—
<b>W-4:CHECK PRNS</b>	Presence speakers were not detected during measurement with “Extra Speaker Assignment” set to “Presence”.	Check the presence speaker connections and perform measurement again. If presence speakers are not connected, set the “Extra Speaker Assignment” to other than “Presence”.	11, 46

## ■ Audio and video synchronization (lip sync)

Lip sync, an abbreviation for lip synchronization, is a technical term that involves both a problem and a capability of maintaining audio and video signals synchronized during post-production and transmission. Whereas the audio and video latency requires complex end-user adjustments, HDMI version 1.3 incorporates an automatic audio and video syncing capability that allows devices to perform this synchronization automatically and accurately without user interaction.

## ■ Bi-amplification connection

A bi-amplification connection uses two amplifiers for a speaker. One amplifier is connected to the woofer section of a loudspeaker while the other is connected to the combined mid and tweeter section. With this arrangement each amplifier operates over a restricted frequency range. This restricted range presents each amplifier with a much simpler job and each amplifier is less likely to influence the sound in some way.

## ■ Component video signal

With the component video signal system, the video signal is separated into the Y signal for the luminance and the Pb and Pr signals for the chrominance. Color can be reproduced more faithfully with this system because each of these signals is independent. The component signal is also called the “color difference signal” because the luminance signal is subtracted from the color signal. A monitor with component input jacks is required in order to output component signals.

## ■ Composite video signal

With the composite video signal system, the video signal is composed of three basic elements of a video picture: color, brightness and synchronization data. A composite video jack on a video component transmits these three elements combined.

## ■ Deep Color

Deep Color refers to the use of various color depths in displays, up from the 24-bit depths in previous versions of the HDMI specification. This extra bit depth allows HDTVs and other displays go from millions of colors to billions of colors and eliminate on-screen color banding for smooth tonal transitions and subtle gradations between colors. The increased contrast ratio can represent many times more shades of gray between black and white. Also Deep Color increases the number of available colors within the boundaries defined by the RGB or YCbCr color space.

## ■ Dolby Digital

Dolby Digital is a digital surround sound system that gives you completely independent multi-channel audio. With 3 front channels (front L/R and center), and 2 surround stereo channels, Dolby Digital provides 5 full-range audio channels. With an additional channel especially for bass effects, called LFE (Low Frequency Effect), the system has a total of 5.1-channels (LFE is counted as 0.1 channel). By using 2-channel stereo for the surround speakers, more accurate moving sound effects and surround sound environment are possible than with Dolby Surround. The wide dynamic range from maximum to minimum volume reproduced by the 5 full-range channels and the precise sound orientation generated using digital sound processing provide listeners with unprecedented excitement and realism. With this unit, any sound environment from monaural up to a 5.1-channel configuration can be freely selected for your enjoyment.

## ■ Dolby Digital Surround EX

Dolby Digital EX creates 6 full-bandwidth output channels from 5.1-channel sources.

For the best results, Dolby Digital EX should be used with movie sound tracks recorded with Dolby Digital Surround EX. With this additional channel, you can experience more dynamic and realistic moving sound especially with scenes with “fly-over” and “fly-around” effects.

## ■ Dolby Digital Plus

Dolby Digital Plus is an advanced audio technology developed for high-definition programming and media including HD broadcasts, and Blu-ray Disc. Selected as an optional audio standard for Blu-ray Disc, this technology delivers multichannel sound with discrete channel output. Supporting bitrates up to 6.0 Mbps, Dolby Digital Plus can carry up to 7.1 discrete audio channels simultaneously. Supported by HDMI version 1.3 and designed for the optical disc players and AV receivers/amplifiers of the future, Dolby Digital Plus also remains fully compatible with the existing multichannel audio systems that incorporate Dolby Digital.

## ■ Dolby Pro Logic II

Dolby Pro Logic II is an improved technique used to decode vast numbers of existing Dolby Surround sources. This new technology enables a discrete 5-channel playback with 2 front left and right channels, 1 center channel, and 2 surround left and right channels instead of only 1 surround channel for conventional Pro Logic technology. There are three modes available: “Music mode” for music sources, “Movie mode” for movie sources and “Game mode” for game sources.

## ■ Dolby Pro Logic IIx

Dolby Pro Logic IIx is a new technology enabling discrete multichannel playback from 2-channel or multi-channel sources. There are three modes available: “Music mode” for music sources, “Movie mode” for movie sources (for 2-channel sources only) and “Game mode” for game sources.

## ■ Dolby Surround

Dolby Surround is widely used with nearly all video tapes and laser discs, and in many TV and cable broadcasts as well. Dolby Surround uses a 4-channel analog recording system to reproduce realistic and dynamic sound effects: 2 front left and right channels (stereo), a center channel for dialog (monaural), and a surround channel for special sound effects (monaural). The surround channel reproduces sound within a narrow frequency range. The Dolby Pro Logic decoder built into this unit employs a digital signal processing system that automatically stabilizes the volume on each channel to enhance moving sound effects and directionality.

## ■ Dolby TrueHD

Dolby TrueHD is an advanced lossless audio technology developed for high-definition disc-based media including Blu-ray Disc. Selected as an optional audio standard for Blu-ray Disc, this technology delivers sound that is bit-for-bit identical to the studio master, offering a high-definition home theater experience. Supporting bitrates up to 18.0 Mbps, Dolby TrueHD can carry up to 8 discrete channels of 24-bit/96 kHz audio simultaneously. Dolby TrueHD also remains fully compatible with the existing multichannel audio systems and retains the metadata capability of Dolby Digital, allowing dialog normalization and dynamic range control.

## ■ DSD

Direct Stream Digital (DSD) technology stores audio signals on digital storage media, such as Super Audio CDs. Using DSD, signals are stored as single bit values at a high-frequency sampling rate of 2.8224 MHz, while noise shaping and oversampling are used to reduce distortion, a common occurrence with very high quantization of audio signals. Due to the high sampling rate, better audio quality can be achieved than that offered by the PCM format used for normal audio CDs. The frequency is equal to or higher than 100 kHz and the dynamic range is 120 dB. This unit can transmit or receive DSD signals input from the HDMI jack.

## ■ DTS 96/24

DTS 96/24 offers an unprecedented level of audio quality for multi-channel sound on DVD video, and is fully backward-compatible with all DTS decoders. “96” refers to a 96 kHz sampling rate compared to the typical 48 kHz sampling rate. “24” refers to 24-bit word length. DTS 96/24 offers sound quality transparent to the original 96/24 master, and 96/24 5.1-channel sound with full-quality full-motion video for music programs and motion picture soundtracks on DVD video.

## ■ DTS Digital Surround

DTS digital surround was developed to replace the analog soundtracks of movies with a 5.1-channel digital sound track, and is now rapidly gaining popularity in movie theaters around the world. DTS, Inc. has developed a home theater system so that you can enjoy the depth of sound and natural spatial representation of DTS digital surround in your home. This system produces practically distortion-free 6-channel sound (technically, front left and right, center, surround left and right, and LFE 0.1 (subwoofer) channels for a total of 5.1 channels). This unit incorporates a DTS-ES decoder that enables 6.1-channel reproduction by adding the surround back channel to the existing 5.1-channel format.

## ■ DTS Express

This is an audio format for next-generation optical discs such as Blu-ray discs. It uses optimized low bit rate signals for network streaming. In the case of a Blu-ray disc, this format is used with secondary audio, enabling you to enjoy the commentary of the movie producer via the Internet while playing the main program.

## ■ DTS-HD High Resolution Audio

DTS-HD High Resolution Audio is a high resolution audio technology developed for high-definition disc-based media including Blu-ray Disc. Selected as an optional audio standard for Blu-ray Disc, this technology delivers sound that is virtually indistinguishable from the original, offering a high-definition home theater experience. Supporting bitrates up to 6.0 Mbps for Blu-ray Disc, DTS-HD High Resolution Audio can carry up to 7.1 discrete channels of 24-bit/96 kHz audio simultaneously.

DTS-HD High Resolution Audio also remains fully compatible with the existing multichannel audio systems that incorporate DTS Digital Surround.

## ■ DTS-HD Master Audio

DTS-HD Master Audio is an advanced lossless audio technology developed for high-definition disc-based media including Blu-ray Disc. Selected as an optional audio standard for Blu-ray Disc, this technology delivers sound that is bit-for-bit identical to the studio master, offering a high-definition home theater experience. Supporting bitrates up to 24.5 Mbps for Blu-ray Disc, DTS-HD Master Audio can carry up to 7.1 discrete channels of 24-bit/96 kHz audio simultaneously. Supported by HDMI version 1.3 and designed for the optical disc players and AV receivers/amplifiers of the future, DTS-HD Master Audio also remains fully compatible with the existing multichannel audio systems that incorporate DTS Digital Surround.

## ■ FLAC

This is a file format for lossless audio data compression. FLAC is inferior to lossy compression formats in compression rate but provides higher audio quality.

## ■ HDMI

HDMI (High-Definition Multimedia Interface) is the first industry-supported, uncompressed, all-digital audio/video interface. Providing an interface between any source (such as a set-top box or AV receiver) and an audio/video monitor (such as a digital television), HDMI supports standard, enhanced or high-definition video as well as multi-channel digital audio using a single cable. HDMI transmits all ATSC HDTV standards and supports 8-channel digital audio, with bandwidth to spare to accommodate future enhancements and requirements.

When used in combination with HDCP (High-bandwidth Digital Content Protection), HDMI provides a secure audio/video interface that meets the security requirements of content providers and system operators. For further information on HDMI, visit the HDMI website at “<http://www.hdmi.org/>”.

## ■ LFE 0.1 channel

This channel reproduces low-frequency signals. The frequency range of this channel is from 20 Hz to 120 Hz. This channel is counted as 0.1 because it only enforces a low-frequency range compared to the full-range reproduced by the other 5/6 channels in Dolby Digital or DTS 5.1/6.1-channel systems.

## ■ Neo:6

Neo:6 decodes the conventional 2-channel sources for 6-channel playback by the specific decoder. It enables playback with the full-range channels with higher separation just like digital discrete signal playback. There are two modes available: “Music mode” for music sources and “Cinema mode” for movie sources.

## ■ PCM (Linear PCM)

Linear PCM is a signal format under which an analog audio signal is digitized, recorded and transmitted without using any compression. This is used as a method of recording CDs and DVD audio. The PCM system uses a technique for sampling the size of the analog signal per very small unit of time. Standing for “Pulse Code Modulation”, the analog signal is encoded as pulses and then modulated for recording.

## ■ Sampling frequency and number of quantized bits

When digitizing an analog audio signal, the number of times the signal is sampled per second is called the sampling frequency, while the degree of fineness when converting the sound level into a numeric value is called the number of quantized bits. The range of rates that can be played back is determined based on the sampling rate, while the dynamic range representing the sound level difference is determined by the number of quantized bits. In principle, the higher the sampling frequency, the wider the range of frequencies that can be played back, and the higher the number of quantized bits, the more finely the sound level can be reproduced.

## ■ “x.v.Color”

A color space standard supported by HDMI version 1.3. It is a more extensive color space than sRGB, and allows the expression of colors that could not be expressed before. While remaining compatible with the color gamut of sRGB standards, “x.v.Color” expands the color space and can thus produce more vivid, natural images. It is particularly effective for still pictures and computer graphics.

# Sound field program information

## ■ Elements of a sound field

What really creates the rich, full tones of a live instrument are the multiple reflections from the walls of the room. In addition to making the sound live, these reflections enable us to tell where the player is situated as well as the size and shape of the room in which we are sitting. There are two distinct types of sound reflections that combine to make up the sound field in addition to the direct sound coming straight to our ears from the player's instrument.

### Early reflections

Reflected sounds reach our ears extremely rapidly (50 ms to 100 ms after the direct sound), after reflecting from one surface only (for example, from a wall or the ceiling). Early reflections actually add clarity to the direct sound.

### Reverberations

These are caused by reflections from more than one surface (for example, from the walls, and/or the ceiling) so numerous that they merge together to form a continuous sonic afterglow. They are nondirectional and lessen the clarity of the direct sound.

Direct sound, early reflections and subsequent reverberations taken together help us to determine the subjective size and shape of the room, and it is this information that the digital sound field processor reproduces in order to create sound fields. If you could create the appropriate early reflections and subsequent reverberations in your listening room, you would be able to create your own listening environment. The acoustics in your room could be changed to those of a concert hall, a dance floor, or a room with virtually any size at all. This ability to create sound fields at will is exactly what Yamaha has done with the digital sound field processor.

## ■ CINEMA DSP

Since the Dolby Surround and DTS systems were originally designed for use in movie theaters, their effect is best felt in a theater having many speakers designed for acoustic effects. Since home conditions, such as room size, wall material, number of speakers, and so on, can differ so widely, it is inevitable that there are differences in the sound heard.

Based on a wealth of actually measured data, Yamaha CINEMA DSP provides the audiovisual experience of a movie theater in the listening room of your own home by using the Yamaha original sound field technology combined with various digital audio systems.

## ■ CINEMA DSP 3D

The actually measured sound field data contain the information of the height of the sound images. CINEMA DSP 3D feature achieves the reproduction of the accurate height of the sound images so that it creates the accurate and intensive stereoscopic sound fields in a listening room.

## ■ SILENT CINEMA

Yamaha has developed a natural, realistic sound effect DSP algorithm for headphones. Parameters for headphones have been set for each sound field so that accurate representations of all the sound field programs can be enjoyed on headphones.

## ■ Virtual CINEMA DSP

Yamaha has developed a Virtual CINEMA DSP algorithm that allows you to enjoy DSP sound field surround effects even without any surround speakers by using virtual surround speakers. It is even possible to enjoy Virtual CINEMA DSP using a minimal two-speaker system that does not include a center speaker.

## ■ Compressed Music Enhancer

The Compressed Music Enhancer feature of this unit enhances your listening experience by regenerating the missing harmonics in a compression artifact. As a result, flattened complexity due to the loss of high-frequency fidelity as well as lack of bass due to the loss of low-frequency bass is compensated, providing improved performance of the overall sound system.

# Information on HDMI™

## ■ HDMI signal compatibility

### Audio signals

Audio signal types	Audio signal formats	Compatible media
2ch Linear PCM	2ch, 32 to 192 kHz, 16/20/24 bit	CD, DVD-Video, DVD-Audio, etc.
Multi-ch Linear PCM	8ch, 32 to 192 kHz, 16/20/24 bit	DVD-Audio, Blu-ray Disc, HD DVD, etc.
DSD	2/5.1ch, 2.8224 MHz, 1 bit	SA-CD, etc.
Bitstream	Dolby Digital, DTS	DVD-Video, etc.
Bitstream (High definition audio)	Dolby TrueHD, Dolby Digital Plus, DTS-HD Master Audio, DTS-HD High Resolution Audio, DTS Express	Blu-ray Disc, HD DVD, etc.



- If the input source component can decode the bitstream audio signals of audio commentaries, you can play back the audio sources with the audio commentaries mixed down by using the following connections:
  - multi-channel analog audio input (page 16)
  - digital input (OPTICAL or COAXIAL)
- Refer to the supplied instruction manuals of the input source component, and set the component appropriately.

### Notes

- When CPPM copy-protected DVD-Audio is played back, video and audio signals may not be output depending on the type of the DVD player.
- This unit is not compatible with HDCP-incompatible HDMI or DVI components.
- To decode audio bitstream signals on this unit, set the input source component appropriately so that the component outputs the bitstream audio signals directly (does not decode the bitstream signals on the component). Refer to the supplied instruction manuals for details.
- This unit is not compatible with the audio commentary features (for example, the special audio contents downloaded via Internet) of Blu-ray Disc or HD DVD. This unit does not play back the audio commentaries of the Blu-ray Disc or HD DVD contents.

### Video signals

This unit is compatible with the video signals of the following resolutions:

- 480i/60 Hz
- 576i/50 Hz
- 480p/60 Hz
- 576p/50 Hz
- 720p/60 Hz, 50 Hz
- 1080i/60 Hz, 50 Hz
- 1080p/60 Hz, 50 Hz, 24 Hz

# Specifications

## AUDIO SECTION

- Minimum RMS Output Power for Front, Center, Surround, Surround back  
20 Hz to 20 kHz, 0.08% THD, 8 Ω ..... 105 W
- Dynamic Power (IHF)  
Front Speakers 8/6/4/2 Ω ..... 140/175/205/250 W
- Maximum Useful Output Power (JEITA)  
[General, China, Korea and Asia models]  
1 kHz, 10% THD, 8 Ω ..... 145 W
- Maximum Output Power [Europe, Russia and Asia models]  
1 kHz, 0.7% THD, 4 Ω ..... 155 W
- Dynamic Headroom [U.S.A. and Canada models]  
8 Ω ..... 1.25 dB
- IEC Output Power [Europe, Russia and Asia models]  
Front Speakers 1 kHz, 0.08% THD, 8 Ω ..... 115 W
- Input Sensitivity/Input Impedance  
PHONO ..... 3.5 mV/47 kΩ  
AV5, etc. .... 200 mV/47 kΩ  
MULTI CH INPUT ..... 200 mV/47 kΩ
- Maximum Input Voltage  
PHONO (1 kHz, 0.1% THD) ..... 60 mV or more  
AV5, etc. (1 kHz, 0.5% THD) ..... 2.0 V or more
- Rated Output Voltage/Output Impedance  
AUDIO OUT ..... 200 mV/1.2 kΩ  
PRE OUT ..... 1.0 V/1.2 kΩ  
SUBWOOFER (2ch Stereo, Front Speaker: Small)  
..... 1.0 V/1.2 kΩ  
ZONE2 OUT ..... 200 mV/1.2 kΩ
- Headphone Jack Rated Output/Impedance  
AV5, etc. (1 kHz, 50 mV, 8 Ω) ..... 100 mV/470 Ω
- Frequency Response  
AV5 to FRONT ..... 10 Hz to 100 kHz, +0/-3 dB
- RIAA Equalization Deviation  
PHONO ..... 0 ± 0.5 dB
- Total Harmonic Distortion  
PHONO to AUDIO OUT  
(20 Hz to 20 kHz, 1 V) ..... 0.02% or less  
AV5, etc. to FRONT, Pure Direct  
(20 Hz to 20 kHz, 50 W, 8 Ω) ..... 0.06% or less
- Signal to Noise Ratio (IHF-A Network)  
PHONO Input Shorted (5.0 mV to AUDIO OUT)  
[U.S.A., Canada, General and China models] ..... 86 dB or more  
[Other models] ..... 81 dB or more  
AV5, etc. Input Shorted (250 mV to Front Speakers)  
..... 100 dB or more
- Residual Noise (IHF-A Network)  
Front Speakers ..... 150 μV or less
- Channel Separation (1 kHz/10 kHz)  
PHONO (Input Shorted) ..... 60 dB/55 dB or more  
AV5, etc. (5.1 kΩ shortened) ..... 60 dB/45 dB or more
- Volume Control ..... Mute / -80 dB to +16.5 dB
- Tone Control (Front Speakers)  
Bass Boost/Cut ..... ±10 dB at 50 Hz  
Bass Turnover Frequency ..... 350 Hz  
Treble Boost/Cut ..... ±10 dB at 20 kHz  
Treble Turnover Frequency ..... 3.5 kHz
- Filter Characteristics (fc=40/60/80/90/100/110/120/160/200 Hz)  
H.P.F. (Front, Center, Surround, Surround back: Small)  
..... 12 dB/oct.  
L.P.F. (Subwoofer) ..... 24 dB/oct.

## VIDEO SECTION

- Video Signal Type (Gray Back)  
[U.S.A., Canada, General and Korea models] ..... NTSC  
[Other models] ..... PAL
- Video Signal Type (Video Conversion) ..... NTSC/PAL
- Signal Level  
Composite ..... 1 Vp-p/75 Ω  
S-video [U.K., Europe and Russia models]  
..... 1 Vp-p/75 Ω (Y), 0.286 Vp-p/75 Ω (C)  
Component ..... 1 Vp-p/75 Ω (Y), 0.7 Vp-p/75 Ω (Cb, Cr)
- Maximum Input Level (Video Conversion: Off)  
..... 1.5 Vp-p or more
- Signal to Noise Ratio ..... 50 dB or more
- Frequency Response [MONITOR OUT]  
Component (Video Conversion: Off)  
..... 5 Hz to 60 MHz, -3 dB

## FM SECTION

- Tuning Range  
[U.S.A. and Canada models] ..... 87.5 to 107.9 MHz  
[General and Asia models] ..... 87.5/87.5 to 108.0/108.0 MHz  
[Other models] ..... 87.50 to 108.00 MHz
- 50 dB Quietening Sensitivity (IHF)  
Mono ..... 3.0 μV (20.8 dBf)
- Signal to Noise Ratio (IHF)  
Mono/Stereo ..... 74 dB/70 dB
- Harmonic Distortion (1 kHz)  
Mono/Stereo ..... 0.3/0.3%
- Antenna Input (unbalanced) ..... 75 Ω

## AM SECTION

- Tuning Range  
[U.S.A. and Canada models] ..... 530 to 1710 kHz  
[General and Asia models] ..... 530/531 to 1710/1611 kHz  
[Other models] ..... 531 to 1611 kHz

## GENERAL

- Power Supply  
[U.S.A. and Canada models] ..... AC 120 V, 60 Hz  
[General model] ..... AC 110/120/220/230-240 V, 50/60 Hz  
[China model] ..... AC 220 V, 50 Hz  
[Korea model] ..... AC 220 V, 60 Hz  
[Australia model] ..... AC 240 V, 50 Hz  
[U.K., Europe and Russia models] ..... AC 230 V, 50 Hz  
[Asia model] ..... AC 220/230-240 V, 50/60 Hz
- Power Consumption  
[U.S.A. and Canada models] ..... 400 W/500 VA  
[Other models] ..... 400 W
- Standby Power Consumption  
(HDMI Control: Off, Standby Through: Off) ..... 0.2 W or less  
(HDMI Control: On, Standby Through: On)  
No Repeat ..... 1.2 W or less  
Repeat ..... 3 W or less
- Maximum Power Consumption  
[General and Asia models] ..... 590 W
- Dimensions (W x H x D) ..... 435 x 171 x 365 mm  
(17-1/8 x 6-3/4 x 14-3/8 in)
- Weight ..... 11.1 kg (24.5 lbs)

\* Specifications are subject to change without notice.

# Index

## ■ Numerics

2ch Stereo, sound field program .....	27
3D DSP, sound field parameter .....	40
5.1-channel speaker layout .....	10
6.1-channel speaker layout .....	10
7.1-channel speaker layout .....	10
7ch Enhancer, sound field program .....	28
7ch Stereo, sound field program .....	28

## ■ A

Action Game, sound field program .....	27
Adaptive DRC, Volume, Function Setup .....	49
Adjusting high frequency sound .....	24
Adjusting low frequency sound .....	24
Advanced setup .....	54
Adventure, sound field program .....	26
AM antenna connection .....	18
AM tuning .....	30
Analog audio jack .....	13
ANTENNA terminal, rear panel .....	5
Aspect, HDMI, Function Setup .....	49
AUDIO 1/2 jack, rear panel .....	5
Audio and video player connection .....	15
Audio jack .....	13
AUDIO L/R (VIDEO AUX) jack, front panel .....	4
AUDIO OUT jack, rear panel .....	5
Audio Output, HDMI, Function Setup .....	48
Audio player connection .....	16
Auto Delay, Lipsync, Sound Setup .....	48
Auto Preset, Option menu .....	38
Auto Setup (YPAO), troubleshooting .....	62
Auto Setup, Speaker Setup .....	45
Automatic setup .....	20
AV 1-6 jack, rear panel .....	5
AV OUT jack, rear panel .....	5

## ■ B

Basic operation, Setup menu .....	45
Bass Crossover Frequency, Manual Setup, Speaker Setup .....	47
BI AMP, advanced setup .....	54
Bi-amplification connection .....	12
Bluetooth component playback .....	34
Bluetooth wireless audio receiver connection .....	17
Bluetooth, troubleshooting .....	61

## ■ C

Cellar Club, sound field program .....	27
Center Image, decoder parameter .....	43
Center Level, sound field parameter .....	42
Center speaker .....	10
Center Speaker, Manual Setup, Speaker Setup .....	46
Center Width, decoder parameter .....	43
Chamber, sound field program .....	27
Changing information on the front panel display .....	25
CINEMA DSP 3D .....	29
CINEMA DSP 3D indicator, front panel display .....	6
CINEMA DSP indicator, front panel display .....	6
Clear Preset, Option menu .....	38
COAXIAL jack .....	13
CODE SET, remote control .....	7
COMPONENT VIDEO jack .....	13
Connect, Option menu .....	39
Connecting audio and video player .....	15
Connecting audio player .....	16
Connecting Bluetooth wireless audio receiver .....	17
Connecting external amplifier .....	17
Connecting external decoder .....	16
Connecting FM antenna .....	18

Connecting iPod universal dock .....	17
Connecting multi-format player .....	16
Connecting power cable .....	19
Connecting projector .....	14
Connecting set-top box .....	15
Connecting speaker .....	11
Connecting speaker cable .....	12
Connecting TV monitor .....	14
Connecting USB storage device .....	18
Connecting Zone2 .....	51
Connections .....	10
Controlling other component, remote control .....	53
Controlling Zone2 .....	52
Cursor indicator, front panel display .....	6
Cursors $\Delta / \nabla / \triangleleft / \triangleright$ , remote control .....	7

## ■ D

Decode Type, sound field parameter .....	42
Decoder Mode, Option menu .....	38
Decoder parameter .....	43
Dialogue Lift, sound field parameter .....	40
Dimension, decoder parameter .....	43
Dimer, Display, Function Setup .....	49
Direct, sound field parameter .....	42
Disconnect, Option menu .....	39
DISPLAY, remote control .....	7
Displaying input signal information .....	25
DOCK terminal, rear panel .....	5
Drama, sound field program .....	27
DSP Level, sound field parameter .....	40
DSP Parameter, Setup menu .....	50
Dynamic Range, Sound Setup .....	47

## ■ E

Editing sound field program .....	40
Editing surround decoder .....	40
Effect Level, sound field parameter .....	43
ENTER, remote control .....	7
EQ Type Select, Manual Setup, Speaker Setup .....	47
Equalizer, Manual Setup, Speaker Setup .....	47
Extended Surround, Option menu .....	38
External amplifier connection .....	17
External component operation key, remote control .....	7
External decoder connection .....	16
Extra Speaker Assignment, Manual Setup, Speaker Setup .....	46

## ■ F

FIRM UPDATE, advanced setup .....	54
Firmware update .....	54
FM antenna connection .....	18
FM Mode, Option menu .....	38
FM tuning .....	30
FM/AM, front panel .....	4
Frequency tuning .....	30
Front left speaker .....	10
Front panel .....	4
Front panel display .....	6
Front Panel Display Scroll, Display, Function Setup .....	49
Front panel display, front panel .....	4
Front right speaker .....	10
Front Speaker, Manual Setup, Speaker Setup .....	46
Function Setup, Setup menu .....	48

## ■ G

GEQ, Manual Setup, Speaker Setup .....	47
GUI Position, Display, Function Setup .....	49

## ■ H

Hall in Munich, sound field program .....	27
Hall in Vienna, sound field program .....	27

HDMI Auto Lipsync, Lipsync, Sound Setup .....	48
HDMI control .....	36
HDMI Control, HDMI, Function Setup .....	48
HDMI indicator, front panel display .....	6
HDMI information .....	67
HDMI jack .....	13
HDMI OUT/HDMI IN 1-4 jack, rear panel .....	5
HDMI THROUGH, front panel .....	4
HDMI, Function Setup .....	48
HDMI, troubleshooting .....	59
Headphones, use .....	25
Hi-fi sound playback .....	24
High frequency sound adjustment .....	24

## ■ I

INFO, front panel .....	4
INFO, remote control .....	7
INIT, advanced setup .....	54
Initial Delay, sound field parameter .....	41
Initial Volume, Volume, Function Setup .....	49
Input Rename, Function Setup .....	50
Input selection key, remote control .....	7
INPUT selector, front panel .....	4
Input signal information display .....	25
Input source registration, SCENE function .....	24
Installing batteries, remote control .....	9
iPod playback .....	32
iPod universal dock connection .....	17
iPod, troubleshooting .....	60

## ■ L

LFE / Bass Out, Manual Setup, Speaker Setup .....	46
Lipsync, Sound Setup .....	48
Liveness, sound field parameter .....	41

## ■ M

MAIN ZONE ON/OFF, front panel .....	4
MAIN/ZONE2, remote control .....	7
Manual Delay, Lipsync, Sound Setup .....	48
Manual Setup, Speaker Setup .....	45
Max Volume, Volume, Function Setup .....	49
Memory Guard, Setup menu .....	50
MEMORY, front panel .....	4
MON.CHK, advanced setup .....	54
MONITOR OUT jack, rear panel .....	5
Mono Movie, sound field program .....	27
Movie, sound field program .....	26
MULTI CH INPUT jack, rear panel .....	5
Multi information display, front panel display .....	6
Multi-format player connection .....	16
Multi-zone configuration .....	51
Music Video, sound field program .....	27
MUTE indicator, front panel display .....	6
MUTE, remote control .....	7

## ■ N

Neo:6 Cinema, decoder .....	28
Neo:6 Music, decoder .....	28
Numeric key, remote control .....	7

## ■ O

ON SCREEN, remote control .....	7
OPTICAL jack .....	13
OPTIMIZER MIC jack, front panel .....	4
Option menu .....	37
OPTION, remote control .....	7

## ■ P

P. Initial Delay, sound field parameter .....	41
P. Room Size, sound field parameter .....	41
Pairing Bluetooth components .....	34
Pairing, Option menu .....	39
Panorama, decoder parameter .....	43

- PHONES jack, front panel ..... 4  
 PHONO jack, rear panel ..... 5  
 Placing speaker ..... 10  
 PLII Game, decoder ..... 28  
 PLII Movie, decoder ..... 28  
 PLII Music, decoder ..... 28  
 PLIIx Game, decoder ..... 28  
 PLIIx Movie, decoder ..... 28  
 PLIIx Music, decoder ..... 28  
 Power cable connection ..... 19  
 Power cable, rear panel ..... 5  
 POWER, remote control ..... 7  
 PRE OUT jack, rear panel ..... 5  
 Presence L Level, sound field parameter ..... 42  
 Presence left speaker ..... 11  
 Presence R Level, sound field parameter ..... 42  
 Presence right speaker ..... 11  
 PRESET ◀ / ▶, front panel ..... 4  
 Preset tuning ..... 30  
 Pro Logic, decoder ..... 28  
 PROGRAM selector, front panel ..... 4  
 Projector connection ..... 14  
 PURE DIRECT, front panel ..... 4
- **R**
- Rear panel ..... 5  
 Receiving remote control signal ..... 17  
 Registering input source, SCENE function ... 24  
 Registering sound field program,  
   SCENE function ..... 24  
 Remote control ..... 7  
 Remote control code resetting ..... 53  
 Remote control code setting ..... 53  
 Remote control ID setting ..... 54  
 Remote control signal transmitter,  
   remote control ..... 7  
 Remote control,  
   controlling other component ..... 53  
 Remote control, preparation ..... 9  
 Remote control, troubleshooting ..... 60  
 Remote control, use ..... 9  
 REMOTE ID, advanced setup ..... 54  
 REMOTE IN/OUT jack, rear panel ..... 5  
 Repeat playback, iPod ..... 33  
 Repeat playback, USB storage device ..... 35  
 Repeat, Option menu ..... 38  
 Resetting remote control code ..... 53  
 Resolution, HDMI, Function Setup ..... 48  
 RETURN, remote control ..... 7  
 Reverb Delay, sound field parameter ..... 42  
 Reverb Level, sound field parameter ..... 42  
 Reverb Time, sound field parameter ..... 42  
 Roleplaying Game, sound field program ..... 27  
 Room Size, sound field parameter ..... 41
- **S**
- SCENE function ..... 23  
 SCENE IR, advanced setup ..... 54  
 SCENE, front panel ..... 4  
 SCENE, remote control ..... 7  
 Sci-Fi, sound field program ..... 26  
 Selecting a source on GUI screen ..... 24  
 Selecting SCENE ..... 23  
 Setting remote control code ..... 53  
 Setting remote control ID ..... 54  
 Setup menu ..... 44  
 Setup menu basic operation ..... 45  
 Shuffle playback, iPod ..... 33  
 Shuffle playback, USB storage device ..... 35  
 Shuffle, Option menu ..... 38  
 Signal Info, Option menu ..... 38  
 SILENT CINEMA ..... 29  
 SLEEP indicator, front panel display ..... 6  
 Sleep timer ..... 36  
 SLEEP, remote control ..... 7  
 Sound field parameter ..... 40  
 Sound field program editing ..... 40  
 Sound field program registration,  
   SCENE function ..... 24
- Sound selection keys, remote control ..... 7  
 Sound Setup, Setup menu ..... 47  
 SOURCE POWER, remote control ..... 7  
 SP IMP., advanced setup ..... 54  
 Speaker cable connection ..... 12  
 Speaker Configuration, Manual Setup,  
   Speaker Setup ..... 45  
 Speaker connection ..... 11  
 Speaker Distance, Manual Setup,  
   Speaker Setup ..... 47  
 Speaker indicator, front panel display ..... 6  
 Speaker layout ..... 10  
 Speaker Level, Manual Setup,  
   Speaker Setup ..... 47  
 Speaker placement ..... 10  
 Speaker Setup, Setup menu ..... 45  
 SPEAKERS terminal, rear panel ..... 5  
 Specifications ..... 68  
 Spectacle, sound field program ..... 26  
 Sports, sound field program ..... 27  
 Standby Through, HDMI, Function Setup ..... 48  
 Staright decode mode ..... 29  
 Straight Enhancer, sound field program ..... 28  
 STRAIGHT, front panel ..... 4  
 Subwoofer ..... 10  
 Subwoofer Phase, Manual Setup,  
   Speaker Setup ..... 47  
 Sur. Back Initial Delay,  
   sound field parameter ..... 41  
 Sur. Back Liveness, sound field parameter .... 41  
 Sur. Back Room Size,  
   sound field parameter ..... 41  
 Sur. Initial Delay, sound field parameter ..... 41  
 Sur. Liveness, sound field parameter ..... 41  
 Sur. Room Size, sound field parameter ..... 41  
 Surround back left speaker ..... 10  
 Surround Back Level,  
   sound field parameter ..... 42  
 Surround back right speaker ..... 10  
 Surround back speaker ..... 10  
 Surround Back Speaker, Manual Setup,  
   Speaker Setup ..... 46  
 Surround decoder editing ..... 40  
 Surround L Level, sound field parameter ..... 42  
 Surround left speaker ..... 10  
 Surround R Level, sound field parameter ..... 42  
 Surround right speaker ..... 10  
 Surround Speaker, Manual Setup,  
   Speaker Setup ..... 46
- **T**
- Test Tone, Manual Setup, Speaker Setup ..... 47  
 The Bottom Line, sound field program ..... 27  
 The Roxy Theatre, sound field program ..... 27  
 Tone control ..... 24  
 TONE CONTROL, front panel ..... 4  
 TRANSMIT, remote control ..... 7  
 Transmitting remote control signal ..... 17  
 TRIGGER OUT jack, rear panel ..... 5  
 Tuner (FM/AM), troubleshooting ..... 59  
 Tuner indicator, front panel display ..... 6  
 Tuner key, remote control ..... 7  
 TUNING ◀ / ▶, front panel ..... 4  
 Tuning, AM ..... 30  
 Tuning, FM ..... 30  
 Turning off ..... 19  
 Turning on ..... 19  
 TV control key, remote control ..... 7  
 TV monitor connection ..... 14
- **U**
- Updating firmware ..... 54  
 USB port, front panel ..... 4  
 USB storage device connection ..... 18  
 USB storage device playback ..... 35  
 USB, troubleshooting ..... 61
- **V**
- VER, advanced setup ..... 54
- VIDEO (VIDEO AUX) jack, front panel ..... 4  
 VIDEO jack ..... 13  
 Video jack ..... 13  
 Video Out, Option menu ..... 39  
 Video/audio jack ..... 13  
 Virtual CINEMA DSP ..... 29  
 VOLUME +/-, remote control ..... 7  
 VOLUME control, front panel ..... 4  
 VOLUME indicator, front panel display ..... 6  
 Volume Trim, Option menu ..... 37  
 Volume, Function Setup ..... 49
- **Y**
- YPAO ..... 20  
 YPAO, troubleshooting ..... 62
- **Z**
- ZONE2 CONTROL, front panel ..... 4  
 ZONE2 indicator, front panel display ..... 6  
 Zone2 Initial Volume, Zone2,  
   Function Setup ..... 50  
 Zone2 Max Volume, Zone2,  
   Function Setup ..... 50  
 ZONE2 ON/OFF, front panel ..... 4  
 ZONE2 OUT jack, rear panel ..... 5  
 Zone2, Function Setup ..... 50

“(Ⓚ) MAIN ZONE ON/OFF” or  
 “(Ⓚ) POWER” (example)  
 indicates the name of the parts on  
 the front panel or the remote  
 control. Refer to “Part names and  
 functions” on page 4.



## **Information about software**

### **About FLAC codec library**

Copyright (C) 2000,2001,2002,2003,2004 Josh Coalson  
Redistribution and use in source and binary forms, with or without modification, are permitted provided that the following conditions are met:

- Redistributions of source code must retain the above copyright notice, this list of conditions and the following disclaimer.
- Redistributions in binary form must reproduce the above copyright notice, this list of conditions and the following disclaimer in the documentation and/or other materials provided with the distribution.
- Neither the name of the Xiph.org Foundation nor the names of its contributors may be used to endorse or promote products derived from this software without specific prior written permission.

THIS SOFTWARE IS PROVIDED BY THE COPYRIGHT HOLDERS AND CONTRIBUTORS “AS IS” AND ANY EXPRESS OR IMPLIED WARRANTIES, INCLUDING, BUT NOT LIMITED TO, THE IMPLIED WARRANTIES OF MERCHANTABILITY AND FITNESS FOR A PARTICULAR PURPOSE ARE DISCLAIMED. IN NO EVENT SHALL THE FOUNDATION OR CONTRIBUTORS BE LIABLE FOR ANY DIRECT, INDIRECT, INCIDENTAL, SPECIAL, EXEMPLARY, OR CONSEQUENTIAL DAMAGES (INCLUDING, BUT NOT LIMITED TO, PROCUREMENT OF SUBSTITUTE GOODS OR SERVICES; LOSS OF USE, DATA, OR PROFITS; OR BUSINESS INTERRUPTION) HOWEVER CAUSED AND ON ANY THEORY OF LIABILITY, WHETHER IN CONTRACT, STRICT LIABILITY, OR TORT (INCLUDING NEGLIGENCE OR OTHERWISE) ARISING IN ANY WAY OUT OF THE USE OF THIS SOFTWARE, EVEN IF ADVISED OF THE POSSIBILITY OF SUCH DAMAGE.

### **About Vorbis library**

Copyright (c) 2001, Xiphophorus  
Redistribution and use in source and binary forms, with or without modification, are permitted provided that the following conditions are met:

- Redistributions of source code must retain the above copyright notice, this list of conditions and the following disclaimer.
- Redistributions in binary form must reproduce the above copyright notice, this list of conditions and the following disclaimer in the documentation and/or other materials provided with the distribution.
- Neither the name of the Xiphophorus nor the names of its contributors may be used to endorse or promote products derived from this software without specific prior written permission.

THIS SOFTWARE IS PROVIDED BY THE COPYRIGHT HOLDERS AND CONTRIBUTORS “AS IS” AND ANY EXPRESS OR IMPLIED WARRANTIES, INCLUDING, BUT NOT LIMITED TO, THE IMPLIED WARRANTIES OF MERCHANTABILITY AND FITNESS FOR A PARTICULAR PURPOSE ARE DISCLAIMED. IN NO EVENT SHALL THE REGENTS OR CONTRIBUTORS BE LIABLE FOR ANY DIRECT, INDIRECT, INCIDENTAL, SPECIAL, EXEMPLARY, OR CONSEQUENTIAL DAMAGES (INCLUDING,

BUT NOT LIMITED TO, PROCUREMENT OF SUBSTITUTE GOODS OR SERVICES; LOSS OF USE, DATA, OR PROFITS; OR BUSINESS INTERRUPTION) HOWEVER CAUSED AND ON ANY THEORY OF LIABILITY, WHETHER IN CONTRACT, STRICT LIABILITY, OR TORT (INCLUDING NEGLIGENCE OR OTHERWISE) ARISING IN ANY WAY OUT OF THE USE OF THIS SOFTWARE, EVEN IF ADVISED OF THE POSSIBILITY OF SUCH DAMAGE.

# List of remote control codes

TV		Ausind		Clatronic		Durabrand	
A.R. Systems	0274	Ausind	0249	Clatronic	0243, 0249, 0259,	Durabrand	0077, 0097, 0133,
Acme	0260	Autovox	0249, 0257, 0259,		0260, 0261, 0262,		0225
Acura	0261, 0273		0260, 0328		0268, 0269, 0273,	Dux	0271
ADC	0259	Aventura	0097		0274, 0328	Dwin	0224
Admiral	0100, 0224, 0257,	Awa	0327, 0328	CMS	0327	Dynatron	0268, 0271, 0274
	0258, 0259, 0264,	Axion	0206	CMS Hightec	0328	Dynex	0181, 0182
	0265	Baird	0328	Coby	0151	Elbe	0243, 0250, 0274,
Advent	0204	Bang & Olufsen	0230, 0257	Colortyme	0072, 0090		0328
Adventura	0107	Basic Line	0261, 0262, 0268,	Commercial Solutions	0071	Elcit	0257
Adyson	0260, 0327, 0328		0273, 0274, 0328			Electa	0270
Agashi	0327, 0328	Bastide	0260, 0328	Concerto	0072, 0090	ELECTRO TECH	0261
Agazi	0259	Baur	0271, 0274	Concorde	0261, 0273	Electroband	0057, 0101
Aiko	0260, 0261, 0273,	Bazin	0328	Condor	0243, 0260, 0268,	Electrograph	0226
	0274, 0327, 0328	Beko	0243, 0269, 0274,		0269, 0273, 0274,	Electrohome	0072, 0090, 0101,
Aim	0274		0282, 0351, 0357,	Contec	0327		0102
Aiwa	0028, 0297	Belcor	0372, 0380		0225, 0260, 0261,	Element	0180
Akai	0063, 0096, 0101,	Bell & Howell	0090	Contec/Cony	0266, 0273, 0327	Elin	0260, 0268, 0271,
	0205, 0231, 0261,	Benq	0065, 0100	Continental Edison	0094, 0104		0273, 0274, 0327
	0262, 0268, 0271,	Beon	0051, 0160, 0315			Elite	0262, 0268, 0274
	0273, 0274, 0327,	Best	0268, 0271, 0274	Cosmel	0267	Elman	0263
	0328	Bestar	0243, 0268, 0274	Craig	0261, 0273	Elta	0261, 0273, 0327
Akiba	0262, 0274	Binatone	0260, 0328	Crosley	0104, 0225	Emerson	0065, 0072, 0077,
Akura	0259, 0262, 0273,	Blue Sky	0260, 0328		0088, 0119, 0249,		0082, 0085, 0090,
	0274	Blue Star	0262, 0274		0257		0094, 0095, 0097,
Alaron	0327	Boots	0270	Crown	0104, 0225, 0243,		0104, 0105, 0119,
Alba	0243, 0260, 0261,	BPL	0260, 0328		0249, 0261, 0268,		0225, 0243, 0257,
	0262, 0266, 0269,	Bradford	0270, 0274		0269, 0271, 0273,	Emprex	0274
	0271, 0273, 0274,	Brandt	0104, 0225	CS Electronics	0274	Envision	0200
	0294, 0300, 0327	Brilliant	0267, 0272		0260, 0262, 0327	Epson	0072, 0090, 0096
Albatron	0222	Brinkmann	0228	CTC Clatronic	0263	Erres	0156, 0201, 0309
Alcyon	0249	Brionvega	0274	CTX	0159	ESA	0268, 0271, 0274
Alleron	0105		0257, 0268, 0271,	Curtis Mathes	0065, 0071, 0072,	ESC	0097
Allorgan	0328	Britannia	0274		0085, 0088, 0090,	Etron	0328
Allstar	0268, 0274	Brockwood	0260, 0327, 0328	CXC	0096, 0099, 0224	Eurofeel	0261
America Action	0225	Broksonic	0090	Cybertron	0104, 0225	Euro-Feel	0328
AMOi	0326	Bruns	0063, 0225	Cytron	0262	Euroline	0259
Amplivision	0243, 0260, 0275,	BTC	0257	Daewoo	0202	Euroman	0271
	0328	Bush	0262		0072, 0085, 0090,	Euromann	0243, 0327, 0328
Amstrad	0259, 0261, 0262,		0261, 0262, 0264,		0103, 0119, 0245,		0259, 0260, 0268,
	0273, 0274		0266, 0268, 0270,		0260, 0261, 0268,	Europhon	0274
Amtron	0104		0271, 0273, 0274,		0273, 0274, 0281,		0260, 0263, 0268,
Anam	0225, 0261		0282, 0286, 0294,		0285, 0303, 0321,	Expert	0274, 0327, 0328
Anam National	0102, 0104		0300, 0328, 0329,		0327, 0328, 0344,	Exquisit	0275
Anglo	0261, 0273		0351, 0388, 0394,		0361, 0387	Fenner	0274
Anitech	0249, 0259, 0261,	Candle	0413	Dainichi	0262, 0327	Ferguson	0261, 0273
	0273, 0274		0072, 0090, 0096,	Dansai	0259, 0268, 0271,	Fidelity	0267, 0271, 0272
Ansonic	0243, 0250, 0261,	Capsonic	0107		0274, 0327, 0328		0260, 0264, 0274,
	0263, 0273, 0274	Carena	0259	Dantax	0243, 0271		0327
AOC	0072, 0090, 0096,	Carnivale	0274	Dawa	0274	Filsai	0328
	0103	Carrefour	0096	Daytron	0072, 0085, 0090,	Finlandia	0264
Apex	0061, 0117, 0139	Carver	0266		0261, 0273	Finlux	0249, 0257, 0260,
Arcam	0327, 0328	Cascade	0088	De Graaf	0264		0263, 0268, 0271,
Arcam Delta	0260	Casio	0261, 0273, 0274	Decca	0260, 0268, 0271,	FIRST LINE	0274, 0328
Aristona	0268, 0271, 0274	Cathy	0317		0274, 0328		0260, 0261, 0268
Arthur Martin	0275	CCE	0268, 0271, 0274	Dell	0167, 0195	Firstline	0273, 0274, 0327,
ASA	0257, 0265	Celebrity	0229, 0328	Denver	0308, 0312		0328
Asberg	0249, 0268, 0274	Celera	0057, 0101	Desmet	0268, 0271, 0274	Fisher	0065, 0243, 0257,
Astra	0261	Centurion	0117	Diamant	0274		0260, 0266, 0269,
Asuka	0259, 0260, 0262,	Century	0268, 0271, 0274	Diamond	0327		0328
	0327, 0328	CGE	0257	DiamondVision	0213, 0221	Flint	0268, 0274
Atlantic	0260, 0268, 0271,	Changhong	0243, 0249	Dimensia	0099	Formenti	0249, 0257, 0258,
	0274, 0327	Chimei	0117	Disney	0137		0260, 0271, 0327
Atori	0261, 0273	Cimline	0323	Dixi	0261, 0268, 0271,	Formenti/Phoenix	0327
Auchan	0275	Citizen	0261, 0273		0273, 0274, 0328	Fortress	0257, 0258
Audiosonic	0243, 0260, 0261,		0072, 0085, 0090,	Dream Vision	0415, 0416	Fraba	0243, 0274
	0262, 0268, 0271,	City	0096, 0104	DTS	0261, 0273	Friac	0243
	0274, 0328	Clarion	0261, 0273	Dual	0260, 0274, 0328	Frontech	0259, 0261, 0264,
AudioTon	0243, 0260, 0328	Clarivox	0225	Dual-Tec	0260, 0261		0265, 0273, 0328
Audiovox	0104, 0144, 0225		0271	Dumont	0076, 0090, 0108,	Fujitsu	0023, 0024, 0025,
					0257, 0260, 0263,		0105, 0328
					0328	Fujitsu General	0328

Fujitsu Siemens	0425, 0426, 0427, 0428, 0429	Hinari	0261, 0262, 0266, 0268, 0271, 0273, 0274	Kaisui	0260, 0261, 0262, 0270, 0273, 0274, 0327, 0328	Magnavox	0072, 0088, 0090, 0091, 0095, 0096, 0098, 0114, 0115, 0129, 0134, 0176, 0178, 0189, 0210
Funai	0033, 0034, 0035, 0036, 0037, 0097, 0104, 0105, 0225, 0259	Hisawa Hisense Hitachi	0262, 0270, 0275 0165 0006, 0014, 0015, 0016, 0042, 0072, 0090, 0094, 0173, 0254, 0255, 0256, 0260, 0264, 0265, 0266, 0274, 0285, 0300, 0319, 0328, 0348, 0349, 0385, 0402, 0410	Kamosonic Kamp Kapsch Karcher	0260 0260, 0327 0265 0243, 0260, 0261, 0271, 0274	Magnum Majestic Mandor	0259, 0261 0100 0259
Futuretech	0104, 0225			Kawasho	0072, 0090, 0101, 0327	Manesth	0259, 0260, 0268, 0271, 0274, 0328
Galaxi	0269, 0274			KEC	0225	Marantz	0072, 0088, 0090, 0096, 0158, 0268, 0271, 0274
Galaxis	0243, 0274			Kendo	0243, 0263, 0264, 0274		
Gateway	0163, 0226, 0227			Kenwood	0072, 0090, 0096	Marelli	0257
GBC	0261, 0266, 0273			KIC	0328	Mark	0268, 0271, 0273, 0274, 0327, 0328
GE	0069, 0071, 0072, 0073, 0077, 0090, 0099, 0102, 0106, 0112, 0131	Hornlyphon	0268, 0274	Kingsley	0260, 0327		
Geant Casino	0275	Hoshai	0262	KLH	0117	Masuda	0328
GEC	0260, 0265, 0268, 0271, 0274, 0328	Huanyu	0260, 0327	Kloss Novabeam	0104, 0107	Matsui	0260, 0261, 0264, 0266, 0268, 0271, 0273, 0274, 0328, 0405
Geloso	0261, 0264, 0273	Hygashi	0260, 0327, 0328	Kneissel	0243, 0250, 0274		
General Technic	0261, 0273	Hyper	0260, 0261, 0273, 0327, 0328	Kolster	0268, 0274		
Genexxa	0262, 0265, 0268, 0274	Hypson	0259, 0260, 0268, 0270, 0271, 0274, 0275, 0328	Konka	0262	Matsushita	0067
GFM	0177, 0210			Korpel	0268, 0271, 0274	Maxent	0193, 0226
Giant	0328	Hyundai	0223	Korting	0243, 0257	Mediator	0268, 0271, 0274
Gibraltar	0076, 0090, 0096, 0108	Iberia	0274	Kosmos	0274	Medion	0259, 0261, 0274
GoldHand	0327	ICE	0259, 0260, 0261, 0262, 0268, 0273, 0274, 0327, 0328	Koyoda	0261	Megapower	0222
Goldline	0274			KTV	0085, 0096, 0104, 0225, 0229, 0260, 0328	Megatron	0072, 0077
GoldStar	0072, 0077, 0085, 0090, 0094, 0096, 0103, 0243, 0260, 0261, 0264, 0268, 0271, 0273, 0274, 0327, 0328	ICeS	0327	Kyoto	0327, 0328	MElectronic	0273, 0274, 0327, 0328
		Ilo	0198, 0203	Lasat	0243	Melvox	0275
		IMA	0104	Lenco	0261, 0273	Memorex	0065, 0072, 0077, 0100, 0103, 0133, 0219, 0261, 0273
		Imperial	0243, 0249, 0265, 0268, 0269, 0274	Lenoir	0260, 0261, 0273		
		Indiana	0268, 0271, 0274	Leyco	0259, 0268, 0271, 0274	Memphis	0261, 0273
Goodmans	0164, 0259, 0261, 0266, 0268, 0271, 0273, 0274, 0322, 0328, 0395, 0399, 0412	Infinity	0088	LG	0016, 0038, 0039, 0077, 0103, 0145, 0222, 0243, 0246, 0253, 0260, 0261, 0264, 0268, 0271, 0273, 0274, 0282, 0290, 0299, 0316, 0327, 0328, 0351, 0359, 0367, 0382, 0384, 0389, 0396	Mercury	0273, 0274
		InFocus	0168, 0277, 0313, 0397, 0430			Metz	0257
		Ingelen	0265			MGA	0072, 0077, 0090, 0096, 0103
		Ingersol	0261, 0273			Micromaxx	0259, 0261
Gorenje	0243, 0269	Initial	0203			Microstar	0259, 0261
GPM	0262	Inno Hit	0249, 0260, 0261, 0262, 0268, 0271, 0273, 0274, 0328			Midland	0069, 0071, 0073, 0076, 0085, 0106, 0108
GPX	0211					Minerva	0249
Gradiente	0162	Innovation	0259, 0261			Minoka	0268, 0274
Graetz	0265	Insignia	0182, 0188, 0190, 0209	LG/GoldStar	0246	Mintek	0203
Granada	0249, 0260, 0264, 0266, 0268, 0271, 0274, 0275, 0328	Inteq	0076	Liesenk	0271	Mitsubishi	0006, 0015, 0016, 0048, 0072, 0077, 0090, 0103, 0196, 0224, 0257, 0266, 0268, 0274, 0298, 0371
Grandin	0261, 0262, 0270, 0271	Interactive	0243	Liesenkotter	0274		
Gronic	0328	Interbuy	0261, 0273	Life	0259, 0261		
Grundig	0242, 0243, 0249, 0274, 0356	Interfunk	0243, 0257, 0265, 0268, 0271, 0274	Lifetec	0259, 0261, 0273, 0274		
Grunpy	0104, 0105, 0225	International	0327	Lloyds	0273		
Haier	0187, 0207	Intervision	0243, 0259, 0260, 0263, 0274, 0328	Loewe	0243, 0250, 0274, 0280, 0306, 0347	Mivar	0243, 0249, 0250, 0260, 0327, 0328
Halifax	0259, 0260, 0327, 0328	Irradio	0249, 0261, 0262, 0268, 0271, 0273, 0274	Loewe Opta	0257, 0268, 0271	Monivision	0222
Hallmark	0072, 0077, 0090			Logik	0100	Montgomery Ward	
Hampton	0260, 0327, 0328	Isukai	0262, 0274	Luma	0264, 0271, 0273, 0274		0100
Hanseatic	0243, 0250, 0260, 0261, 0266, 0268, 0271, 0273, 0274, 0328	ITC	0260, 0328	Lumatron	0264, 0268, 0271, 0274, 0328	Motion	0249
		ITS	0262, 0268, 0270, 0274, 0327	Lux May	0268	Motorola	0102, 0224
		ITV	0261, 0265	Luxman	0072, 0090	MTC	0072, 0090, 0096, 0103, 0243, 0327
Hantarex	0261, 0273, 0274	ITT	0261, 0271, 0274	Luxor	0260, 0264, 0328	Multi System	0271
Hantor	0274	ITV	0261, 0271, 0274	LXI	0061, 0065, 0071, 0072, 0073, 0077, 0088, 0099	Multitech	0104, 0225, 0229, 0243, 0260, 0261, 0263, 0264, 0266, 0271, 0273, 0274, 0327, 0328
Harman/Kardon	0088	Jancil	0107				
Harvard	0104, 0225	JBL	0088			Murphy	0260, 0327
Harwood	0273, 0274	JC Penney	0072, 0073, 0085, 0090, 0099, 0103, 0106	M Electronic	0260, 0261, 0265, 0267, 0268, 0271	NAD	0061, 0072, 0077
Havermy	0224			MAG	0050	Naonis	0264
HCM	0259, 0260, 0261, 0270, 0273, 0274, 0328	JCB	0057, 0101	Magnadyne	0257, 0263, 0271	NEC	0266, 0053, 0072, 0090, 0096, 0102, 0103, 0266, 0328
		Jensen	0072, 0090	Magnafon	0249, 0260, 0263, 0327		
Hema	0273, 0328	JVC	0017, 0018, 0019, 0092, 0093, 0094, 0106, 0251, 0252, 0266, 0268, 0293, 0360, 0379				
Hewlett Packard	0146						
Higashi	0327						
HiLine	0274						

Neckermann	0243, 0257, 0260, 0264, 0268, 0269, 0271, 0274, 0328		0114, 0135, 0143, 0176, 0178, 0189, 0210, 0212, 0232, 0233, 0257, 0260, 0268, 0271, 0274, 0278, 0287, 0301, 0302, 0307, 0311, 0314, 0330, 0331, 0333, 0337, 0338, 0339, 0341, 0343, 0345, 0355, 0363, 0365, 0377, 0378, 0381, 0383, 0406, 0409, 0414	RCA	0071, 0072, 0073, 0074, 0075, 0090, 0099, 0102, 0103, 0109, 0120, 0179, 0218	SEI-Sinudyne Seleco Sencora Sentra Serino Sharp	0257, 0263, 0265 0264, 0265, 0266 0261, 0273 0273 0327 0009, 0010, 0011, 0072, 0080, 0081, 0082, 0083, 0085, 0090, 0094, 0110, 0148, 0183, 0216, 0224, 0247, 0248, 0258, 0266, 0288, 0304, 0324, 0325, 0340, 0358, 0362, 0369, 0386, 0392, 0398, 0400, 0401, 0403	
NEI	0268, 0271, 0274			Realistic	0065, 0077, 0096, 0225			
Net-TV	0226			Recor	0274			
Neufunk	0273, 0274			Redstar	0274			
New Tech	0261, 0268			Reflex	0274			
New World	0262			Revex	0243, 0268, 0271, 0274			
NewTech	0273, 0274, 0328			Rex	0259, 0264, 0265			
Nicamagic	0260, 0327			RFT	0243, 0250, 0257			
Nikkai	0259, 0260, 0262, 0268, 0271, 0273, 0274, 0327, 0328			Rhapsody	0327			
Nikko	0072, 0077, 0096			R-Line	0268, 0271, 0274			
Nobliko	0249, 0260, 0263, 0327	Philips Magnavox Phoenix	0089, 0114, 0115 0243, 0257, 0268, 0271, 0274, 0327	Roadstar	0259, 0261, 0262, 0273	Sheng Chia	0224	
Nokia	0265			Robotron	0257	Shogun	0090	
Norcent	0155	Phonola	0257, 0268, 0271, 0274, 0327	Rowa	0327, 0328	Sierra	0257, 0263, 0274	
Nordic	0328			Royal Lux	0243	Sierra	0268, 0274	
Nordmende	0257, 0265, 0267, 0268	Pilot Pioneer	0085, 0090, 0096 0012, 0013, 0072, 0090, 0243, 0265, 0267, 0268, 0271, 0274, 0408	RTF	0257	Siesta	0243	
Nordvision	0271			Runco	0076, 0096, 0108	Signature	0100	
Novatronic	0274			Saba	0257, 0265, 0267, 0272, 0376	Silva	0327	
Oceanic	0265, 0275			Saisha	0259, 0260, 0261, 0273, 0328	Silver	0266	
Okano	0243, 0269, 0274	Plantron	0259, 0268, 0273, 0274			Singer	0257, 0263, 0275	
Olevia	0052, 0140, 0149, 0154, 0157	Playsonic Polaroid	0328 0117, 0152, 0184, 0220	Salora	0264, 0265	Sinudyne	0257, 0263, 0271, 0274	
ONCEAS	0260			Sambers	0249, 0263	Skantic	0265	
Onwa	0104, 0225			Sampo	0072, 0085, 0090, 0096, 0226	Solavox	0265	
Opera	0274	Poppy	0261, 0273			Sonitron	0243, 0328	
Oppo	0208	Portland	0072, 0085, 0090, 0103	Samsung	0029, 0030, 0031, 0032, 0044, 0045, 0046, 0047, 0072, 0077, 0084, 0085, 0086, 0087, 0090, 0094, 0096, 0103, 0118, 0217, 0229, 0235, 0236, 0237, 0243, 0259, 0260, 0261, 0268, 0269, 0271, 0273, 0274, 0284, 0295, 0327, 0328, 0336, 0346, 0390, 0407		Sonoko	0259, 0260, 0261, 0268, 0271, 0273, 0274, 0328
Optimus	0065, 0067					Sonorlor	0265, 0275	
Optoma	0194	Prandoni-Prince	0249, 0264			Sontec	0243, 0268, 0271, 0274	
Optonica	0224	Precision	0260, 0328			Sony	0041, 0057, 0058, 0059, 0060, 0101, 0116, 0125, 0126, 0127, 0142, 0169, 0170, 0171, 0172, 0174, 0234, 0261, 0266, 0276, 0289, 0292, 0393, 0411	
Orbit	0268, 0274	Prima	0161, 0207, 0261, 0265, 0273			Sound & Vision	0262, 0263	
Orion	0121, 0192, 0261, 0268, 0271, 0273, 0274, 0282, 0329	Princeton Prism Profex	0222 0069, 0106 0261, 0273			Soundesign	0072, 0077, 0090, 0104, 0105, 0225	
Online	0274	Profline	0268, 0274			Soundwave	0268, 0271, 0274	
Osaki	0259, 0260, 0262, 0274, 0328	Profi-Tronic	0268, 0274			Squareview	0097	
Oso	0262	Proscan	0071, 0073, 0099			SSS	0090, 0104, 0225	
Otto Versand	0258, 0260, 0266, 0268, 0270, 0271, 0274, 0328	Prosonic	0243, 0260, 0271, 0274, 0327, 0328			Standard	0260, 0261, 0262, 0268, 0273, 0274, 0328	
Pael	0260, 0327	Protech	0259, 0260, 0261, 0263, 0268, 0271, 0328	Sandra	0260, 0327, 0328	Starlite	0104, 0225, 0271, 0273, 0274	
Palladium	0243, 0260, 0269, 0274, 0328	Proton	0072, 0077, 0090, 0094	Sansui	0063, 0121, 0268, 0274	Stenway	0270	
Palsonic	0328			Sanyo	0020, 0021, 0022, 0049, 0065, 0090, 0141, 0191, 0243, 0250, 0260, 0266, 0273, 0291, 0327, 0328, 0370, 0373, 0391	Stern	0264, 0265	
Panama	0259, 0260, 0261, 0273, 0274, 0327, 0328	Protron PROVIEW Provision	0150 0050, 0164 0271, 0274			Strato	0273, 0274	
Panasonic	0006, 0007, 0066, 0067, 0068, 0069, 0070, 0102, 0106, 0113, 0147, 0215, 0241, 0265, 0274, 0279, 0310, 0332, 0334, 0368, 0374	Pulsar Pye Pymi Quandra Vision Quasar	0076, 0090, 0108 0268, 0271, 0274, 0296, 0338 0261, 0273 0275 0067, 0069, 0102, 0106	SBR Sceptre Schaub Lorenz Schneider	0271, 0274 0166, 0185 0265 0260, 0262, 0268, 0271, 0274, 0287, 0300, 0328, 0364, 0366	Stylandia Sunkai Sunstar Sunwood	0328 0104, 0225, 0271, 0273, 0274 0270 0264, 0265 0273, 0274 0261 0273, 0274 0261, 0268, 0273, 0274	
Panavision	0274	Quelle	0259, 0260, 0268, 0271, 0274, 0328			Supera	0260, 0327, 0328	
Pathe Cinema	0243, 0250, 0260, 0275, 0327	Questa	0266			Superscan	0095, 0224	
Pausa	0261, 0273	Radialva	0274			SuperTech	0273, 0274, 0327	
Penney	0061, 0069, 0071, 0077, 0096	RadioShack	0065, 0071, 0077, 0096, 0225, 0274	Scotch Scott	0072, 0077 0072, 0077, 0090, 0094, 0104, 0105, 0199, 0225	Supra	0261, 0273	
Perdio	0274, 0327	RadioShack/Realistic	0072, 0085, 0090, 0094, 0099, 0104	Sears	0061, 0065, 0071, 0072, 0073, 0077, 0088, 0090, 0097, 0099, 0105	Supre-Macy	0107	
Perfekt	0274					Supreme	0057, 0101	
Philco	0072, 0088, 0090, 0091, 0094, 0096, 0102, 0103, 0243, 0249, 0257, 0274	Radiola	0268, 0271, 0274, 0328			Susumu	0262	
Philharmonic	0260, 0328	Radiomarelli	0257, 0274	SEG	0259, 0260, 0263, 0266, 0271, 0273, 0274, 0300, 0327, 0328	Sutron	0261, 0273	
Philips	0040, 0088, 0089, 0090, 0091, 0094, 0098, 0099, 0102,	Radiotone	0243, 0268, 0273, 0274			SVA	0197	
		Rank	0266	SEI	0274	Sydney	0260, 0327, 0328	

Sylvania	0072, 0088, 0089, 0090, 0091, 0095, 0096, 0097, 0098, 0175, 0177, 0210	Triumph Uher  Ultravox	0274 0243, 0249, 0265, 0268, 0274 0257, 0260, 0263, 0274, 0327	Adventura Adyson Aiwa	1023 1090 1023, 1072, 1073, 1074	Dumont Durabrand Dynatech Echostar	1072, 1078 1032 1023 1064
Symphonic	0097, 0104, 0108, 0133, 0210, 0225	Unic Line United	0274 0271	Akai Akiba	1071, 1073 1079, 1090	Elbe Elcotech	1091 1090
Syntax	0149	Universum	0243, 0249, 0259, 0268, 0269, 0271, 0274, 0328	Akura Alba	1073, 1079, 1090 1074, 1075, 1076, 1079, 1090, 1091	Electrohome Electroponic Elsay	1021 1021 1090
Syntax-Brilliant	0149			Alienware	1066	Elta	1079, 1090, 1091
Sysline	0271	Univox	0274	Ambassador	1076	Emerson	1021, 1022, 1023, 1070, 1090
Sytong	0327	Vector Research	0096	American High	1022	ESC	1075, 1091
Tandy	0224, 0258, 0260, 0262, 0265, 0328	Vestel	0264, 0265, 0268, 0269, 0271, 0274, 0328	Amstrad Anitech	1072, 1090, 1091 1079, 1090	Etzuko Expressvu	1079, 1090 1064
Tashiko	0260, 0264, 0266, 0327, 0328	Vexa	0261, 0271, 0273, 0274	Apex ASA	1010 1077, 1078	Ferguson Fidelity	1064 1073 1072, 1090
Tatung	0102, 0227, 0260, 0268, 0271, 0274, 0328	Victor	0093, 0266, 0268	Asha Asuka	1020 1072, 1077, 1078, 1079, 1090	Finlandia Finlux Firstline	1078 1072, 1073, 1078 1074, 1077, 1079, 1090
TCM	0259, 0261	VIDEOLIGIC	0327	Audio Dynamics	1018	Fisher	1019
Teac	0274, 0328	Videologique	0260, 0262, 0327, 0328	Audiosonic	1091	Flint	1074
Tec	0260, 0261, 0273, 0328	VideoSystem	0268, 0274	Audiovox	1021	Formenti/Phoenix	1078
Technics	0067, 0069, 0106	Videtechnic	0327, 0328	Baird	1072, 1073, 1075, 1091	Frontech	1076
TechniSat	0320, 0417, 0418, 0419	Vidikron	0088	Bang & Olufsen	1067	Fuji	1022
Techwood	0069, 0072, 0090, 0106	Vidtech	0072, 0077, 0090, 0103	Basic Line	1074, 1075, 1076, 1079, 1090, 1091	Fujitsu Funai	1072 1023, 1072
TEDELEX	0072, 0085, 0088, 0090, 0094, 0100, 0103, 0104, 0105, 0225	Viewsonic	0153, 0186, 0226, 0318	Baur	1078	Galaxy	1072
Teknika	0103, 0104, 0105, 0225	Viking	0107	Beaumarck	1020	Garrard	1023
Teleavia	0267	Viore	0198	Bell & Howell	1019	Gateway	1066
Telecor	0274, 0328	Visiola	0260, 0327	Bestar	1075, 1076, 1091	GBC	1076, 1079
Telefunken	0267, 0268, 0272, 0274	Vision	0268, 0274, 0328	Black Panther Line	1075, 1091	GE	1020, 1022
Telegazi	0274	Vizio	0090, 0136, 0160, 0227, 0420, 0421, 0422, 0423, 0424	Blaupunkt	1078	GEC	1078
Telemeister	0274	Vortec	0268, 0271, 0274	Bondstec	1076, 1090	Geloso	1079
Telesonic	0274	Voxson	0249, 0257, 0264, 0265, 0268, 0274	Broksonic	1054	General	1076
Telestarc	0274			Bush	1074, 1075, 1079, 1090, 1091, 1097, 1099, 1109, 1139	General Technic GOI	1074 1064
Teletech	0261, 0271, 0273, 0274	Waltham	0260, 0274, 0328	Black Panther Line		GoldHand	1079, 1090
Teleton	0260, 0328	Wards	0072, 0077, 0088, 0090, 0091, 0096, 0098, 0099, 0100, 0103, 0105	Calix	1021	Goldstar	1018, 1021, 1072, 1077
Televideon	0327			Candle	1020, 1021	Goodmans	1072, 1075, 1076, 1077, 1079, 1090, 1091
Televideo	0275	Watson	0268, 0271, 0274	Canon	1022		
Tensai	0261, 0262, 0268, 0273, 0274, 0328	Watt Radio	0260, 0263, 0327	Cathay	1091	Gradiente	1023
Tesmet	0268	Waycon	0061	Catron	1076	Graetz	1073
Tevion	0259, 0261	Wega	0257, 0266, 0274	CGE	1072, 1073	Granada	1078
Texet	0260, 0273, 0327, 0328	Wegavox	0273	Cimline	1074, 1079, 1090	Grandin	1072, 1075, 1076, 1077, 1079, 1090, 1091
Thomson	0238, 0239, 0240, 0260, 0267, 0268, 0272, 0274, 0335 0271, 0274	Weltblick	0268, 0271, 0274, 0328	CineVision	1058		
Thorn		Westinghouse	0057, 0138, 0142	Citizen	1020, 1021		
TMK	0072, 0077, 0090	White Westinghouse	0008, 0119, 0260, 0263, 0271, 0274, 0327	Clatronic	1076, 1090		
TNCi	0076			Colortyme	1018		
Tokai	0268, 0274, 0328	Wincom	0055, 0056	Condor	1075, 1076, 1091	Grundig	1078, 1079
Tokyo	0260, 0327	Xrypton	0274	Craig	1020, 1021	Hanseatic	1077, 1078, 1091
Tomashi	0270	Yamaha	0000, 0001, 0002, 0003, 0004, 0005, 0072, 0090, 0096, 0103	Crown	1075, 1076, 1079, 1090, 1091	Harley Davidson	1023
Toshiba	0027, 0043, 0053, 0054, 0061, 0062, 0063, 0064, 0065, 0122, 0123, 0124, 0128, 0130, 0132, 0139, 0214, 0244, 0266, 0283, 0305, 0328, 0329, 0342, 0350, 0352, 0353, 0354, 0375, 0404	Yamishi	0274, 0328	CyberPower	1066	Harman/Kardon	1018
Totevision	0085	Yokan	0274	Daewoo	1023, 1075, 1076, 1091, 1116, 1141	Harwood	1090
Towada	0265, 0328	Yoko	0243, 0259, 0260, 0261, 0262, 0268, 0271, 0273, 0274, 0327, 0328	Dansai	1079, 1090, 1091	HCM	1079, 1090
Trakton	0328			Dantax	1074	Headquarter	1019
Trans Continens	0274, 0328	Yorx	0262	Daytron	1075, 1091	Hewlett Packard	1066
Transtec	0327	Zanussi	0264, 0328	De Graaf	1078	Hinari	1074, 1079, 1090, 1091
Trident	0328	Zenith	0076, 0077, 0078, 0079, 0090, 0100, 0108, 0111	Decca	1072, 1073, 1078	Hisawa	1074
				Dell	1066	Hitachi	1072, 1073, 1078, 1089, 1108, 1124
				Denko	1090	HNS	1060
				DiamondVision	1050	Howard Computers	1066
				DigiFusion	1092		1066
				DIRECTV	1035, 1038, 1040, 1059, 1060, 1061, 1065	HP	1066
				Dish Network	1064	HTS	1064
				Dishpro	1064	Hughes	1035, 1040, 1061
				Dual	1073, 1078, 1091	Hughes Network Systems	1038, 1060
						Humax	1035, 1060, 1094
						Hush	1066
						Hypson	1074, 1079, 1090, 1091

---

### VCR

ABS 1066

iBUYPOWER	1066	Multitech	1020, 1023, 1072,	Ricavision	1066	Telefunken	1073
Impego	1076		1076, 1078, 1079,	Roadstar	1075, 1077, 1079,	Teletech	1090, 1091
Imperial	1072		1090		1090, 1091	Tenosal	1079, 1090
Inno Hit	1075, 1076, 1078,	Murphy	1072	Royal	1090	Tensai	1072, 1077, 1079,
	1079, 1090, 1091	NEC	1018, 1019, 1073	Runco	1032		1090
Innovation	1074	Neckermann	1073, 1078	Saba	1073	Tevion	1074
Instant Replay	1022	NEI	1078	Saisho	1074, 1079	Thomson	1073, 1087
Interbuy	1077, 1090	Nesco	1079, 1090	Samsung	1006, 1020, 1038,	Thorn	1073
Interfunk	1078	Nikkai	1076, 1090, 1091		1040, 1046, 1060,	Tivo	1035, 1036, 1037,
Intervision	1072, 1091	Nikko	1021		1080, 1107, 1110,		1039, 1040, 1060,
Irradio	1077, 1079, 1090	Niveus Media	1066		1112, 1121, 1123,		1061, 1062
ITT	1073	Noblex	1020		1140, 1142	TMK	1020
ITV	1075, 1077, 1091	Nokia	1073, 1091	Samurai	1076, 1090	Tokai	1077, 1079, 1090
JC Penney	1018, 1019, 1020,	Nordmende	1073	Sanky	1032	Tonsai	1079
	1021, 1022	Northgate	1066	Sansui	1033, 1056, 1069,	Toshiba	1004, 1005, 1034,
JCL	1022	Oceanic	1072, 1073		1073		1051, 1063, 1066,
JVC	1011, 1012, 1013,	Okano	1074, 1090, 1091	Sanyo	1019, 1020, 1114		1073, 1078, 1086,
	1014, 1015, 1016,	Olympus	1022	Saville	1091		1099, 1102, 1119,
	1017, 1018, 1019,	Optimus	1021	SBR	1078		1144
	1028, 1035, 1064,	Orion	1033, 1069, 1074,	Schaub Lorenz	1072, 1073	Totevision	1020, 1021
	1073, 1085, 1117,		1097, 1139	Schneider	1072, 1074, 1075,	Touch	1066
	1130, 1131, 1133,	Orson	1072		1076, 1077, 1078,	Towada	1079, 1090
	1134, 1135, 1136	Osaki	1072, 1077, 1079,		1079, 1090, 1091	Towika	1079, 1090
Kaisui	1079, 1090		1090	Sears	1019, 1021, 1022	TVA	1076
Karcher	1078	Otto Versand	1078	SEG	1079, 1090, 1091	Uher	1077
Kendo	1074, 1075, 1076,	Palladium	1073, 1077, 1079,	SEI-Sinudyne	1078	UltimateTV	1065
	1090		1090	Seleco	1073	Ultravox	1091
Kenwood	1018, 1019, 1073	Panasonic	1007, 1008, 1009,	Sentra	1076, 1090	Unitech	1020
Kodak	1021, 1022		1022, 1026, 1042,	Sentron	1079, 1090	United Quick Star	1075, 1091
Korpel	1079, 1090		1043, 1068, 1082,	Sharp	1031, 1045, 1057,	Universum	1072, 1077, 1078
Kyoto	1090		1101, 1126, 1132		1081, 1115, 1137	Vector Research	1018
Lenco	1075	Pathe Marconi	1073	Shintom	1079, 1090	Video Concepts	1018
Leyco	1079, 1090	Perdio	1072	Shivaki	1077	Videon	1074
LG	1021, 1053, 1072,	Philco	1022, 1090	Shogun	1020	Videosonic	1020
	1077, 1088, 1100,	Philips	1022, 1030, 1035,	Siemens	1077	Viewsonic	1066
	1106, 1125, 1143		1038, 1039, 1040,	Silva	1077	Voodoo	1066
Lifetec	1074		1044, 1055, 1060,	Silver	1091	Wards	1020, 1021, 1022,
Linksys	1066		1078, 1084, 1095,	Singer	1022		1023
Lloyd's	1023		1096, 1104, 1105,	Sinudyne	1078	Weltblick	1077
Loewe Opta	1077, 1078		1111, 1113, 1122,	Solavox	1076	XR-1000	1022, 1023
Logik	1079, 1090		1124, 1127, 1128,	Sonic Blue	1041, 1068	Yamaha	1018, 1019
Lumatron	1075, 1091		1129	Sonneclair	1090	Yamishi	1079, 1090
Luxor	1090	Philips Magnavox	1030	Sonoko	1075, 1091	Yokan	1079, 1090
LXI	1021	Phonola	1078	Sontec	1077	Yoko	1076, 1077, 1079,
M Electronic	1072	Pilot	1021	Sony	1000, 1001, 1002,		1090
Magnavox	1022, 1032, 1044,	Pioneer	1078, 1118		1003, 1024, 1027,	Zenith	1032
	1070	Polaroid	1010, 1049		1036, 1062, 1066,	ZT Group	1066
Magnin	1021	Portland	1075, 1076, 1091		1083, 1098, 1103,		
Manesth	1079, 1090	Prinz	1072		1138		
Marantz	1018, 1019, 1022,	Profex	1079	Stack	1066	<b>DVD</b>	
	1078	Proline	1072	Stack 9	1066	4Kus	2097
Mark	1091	Proscan	1065	Standard	1075, 1091	Accurian	2220
Marta	1021	Prosonic	1074, 1091	Stern	1091	Advent	2169, 2201
Matsui	1074, 1077	Pulsar	1032	STS	1022	AEG	2312
Matsushita	1022	Pye	1052, 1078	Sunkai	1074	Airis	2318
Media Center PC	1066	Quarter	1019	Sunstar	1072	Aiwa	2272
Mediator	1078	Quartz	1019	Suntronic	1072	Akai	2170, 2195, 2225,
Medion	1074	Quasar	1022	Sunwood	1079, 1090		2227
MEI	1022	Quelle	1072, 1078	Superscan	1070	Akura	2310
Memorex	1019, 1020, 1021,	Radialva	1090	Sylvania	1022, 1023, 1044,	Alba	2018, 2232, 2247,
	1022, 1023, 1032,	RadioShack	1021		1052, 1070		2259, 2264
	1048, 1069, 1072,	RadioShack/Realistic	1019, 1020, 1021,	Symphonic	1023, 1044, 1090	Alco	2199
	1077		1022, 1023	Systemax	1066	Alize	2315
Memphis	1079, 1090			Tagar Systems	1066	Allegro	2215
MGN Technology	1020	Radiola	1078	Taisho	1074	Amitech	2312
Micromaxx	1074	Radix	1021	Tandberg	1091	Amphion MediaWorks	
Microsoft	1066	Randex	1021	Tandy	1019		2145
Microstar	1074	RCA	1020, 1022, 1025,	Tashiko	1021, 1072	AMW	2145, 2313
Migros	1072		1035, 1040, 1047,	Tatung	1072, 1073, 1078	Apex	2044, 2045, 2046,
Mind	1066		1060, 1065	TCM	1074, 1093, 1120		2047, 2076, 2208,
Mitsubishi	1029, 1072, 1078	Realistic	1019, 1020, 1021,	Teac	1023, 1091		2209
Motorola	1022		1022, 1023	Tec	1076, 1090, 1091	Apple	2163
MTC	1020	ReplayTV	1041, 1068	Technics	1022	Argo	2216
		Rex	1073	Teknika	1021, 1022, 1023	Asono	2318
		RFT	1076, 1078, 1090	Teleavia	1073	Aspire	2140, 2202
						Astar	2162

ATACOM	2318	Enzer	2302	LG	2080, 2107, 2115,	2252, 2256, 2260,
Audiovox	2111, 2199	Epson	2165		2116, 2141, 2188,	2268, 2282, 2332,
Avious	2317	ESA	2219		2211, 2215, 2237,	2333, 2343, 2344,
Awa	2313	Finlux	2304, 2312, 2317		2239, 2285, 2293,	2345, 2367, 2371,
Axion	2171	Fintec	2299		2295, 2348, 2370	2373, 2380, 2382,
Bang & Olufsen	2210	Fisher	2212	Life	2228	2385
Baze	2317	Funai	2219	Lifetec	2228	Phonotrend 2317
BBK	2318	Gateway	2097	Limit	2305	Pioneer 2012, 2013, 2014,
Bellagio	2313	GE	2079, 2206, 2209	Liquid Video	2204	2063, 2064, 2065,
Best Buy	2309	Gericom	2269	Liteon	2097, 2121, 2220	2066, 2067, 2113,
Blaupunkt	2209	GFM	2176	Loewe	2274	2134, 2207, 2230,
Blue Parade	2207	Giec	2300	LogicLab	2305	2236, 2265, 2266,
Boghe	2300	Global Solutions	2305	Magnavox	2075, 2096, 2178,	2267, 2297, 2322,
Brainwave	2312	Global Sphere	2305		2180, 2196, 2205,	2351, 2352, 2353,
Brandt	2198, 2238	Go Video	2135, 2215		2219, 2308	2354, 2355, 2356,
Broksonic	2192, 2195	Goodmans	2247, 2289, 2298,	Magnex	2317	2357, 2358, 2359,
Bush	2018, 2060, 2248,		2300, 2308, 2330,	Majestic	2314	2377
	2264, 2301, 2308,		2369	Marantz	2282	Pointer 2312
	2317, 2350, 2368	GPX	2177	Marquant	2312	Polaroid 2047, 2133, 2185
California Audio Labs		Gradiente	2197	Matsui	2198, 2296	Portland 2312
	2197	Graetz	2302	McIntosh	2149	Powerpoint 2313
Cambridge Audio	2304	Greenhill	2209	Mecotek	2312	Prima 2174
CAT	2306, 2307	Grundig	2271	Medion	2228	Proceed 2208
CAVS	2146	Grunkel	2312, 2316	Memorex	2078, 2184, 2195	Proscan 2206
Centrum	2307	GVG	2299	MiCO	2300, 2304	Prosonic 2299, 2314
CGV	2304, 2312	H&B	2308	Micromaxx	2228	Protron 2152
Changhong	2222	H_her	2318	Microsoft	2206	Provision 2308
Cinetec	2313	Haaz	2304, 2305	Microstar	2228	Pye 2194
CineVision	2191, 2215	Haier	2172	Minoka	2312	Qwestar 2198
Clatronic	2308, 2317	Hamman/Kardon	2125, 2213	Minowa	2317	Raite 2302
Coby	2077, 2124, 2314	HiMAX	2309	Mintek	2167, 2209	RCA 2058, 2059, 2071,
Conia	2301	Hitachi	2008, 2033, 2108,	Mitsubishi	2081	2079, 2183, 2199,
Continental Edison			2302, 2309, 2320,	Mizuda	2308, 2309	2206, 2207, 2209
	2313		2366	Monyka	2302	RedStar 2310, 2312, 2314
Crown	2312	Hiteker	2208	Mustek	2232	Regent 2203
C-Tech	2305	Home Tech Industries		Mx Onda	2304	Reoc 2305
Curtis Mathes	2217		2318	Mystral	2316	Rimax 2315
CVG	2299	Hyundai	2316	Naiko	2312	Rio 2215
CyberHome	2048, 2068, 2216,	Ilo	2167	Nesa	2209	Roadstar 2281, 2308
	2233, 2258	Initial	2167, 2209	Neufunk	2302	Ronin 2313
Cytron	2166	Innovation	2228	Nevir	2312	Rotel 2153
Daenyx	2313	Insignia	2080, 2175, 2219	Next Base	2221	Rowa 2200, 2301
Daewoo	2083, 2215, 2280,	Integra	2207	Nexstech	2161	Rownsonic 2307
	2299, 2312, 2313,	Irradio	2103	NU-TEC	2301	Saba 2198, 2238
	2326, 2376	iSymphony	2164	Onkyo	2205, 2290	Sabaki 2305
Daewoo International		JBL	2213	Oopla	2097	Saivod 2312
	2313	JVC	2049, 2050, 2051,	Oppo	2150, 2173	Sampo 2223
Dalton	2311		2052, 2053, 2054,	Optim	2303	Samsung 2031, 2032, 2033,
Dansai	2303, 2312		2055, 2056, 2057,	Optimus	2230	2034, 2035, 2082,
Daytek	2145, 2234, 2313		2070, 2242, 2261,	Orava	2308	2127, 2137, 2138,
Dayton	2313		2275, 2276, 2277,	Orbit	2313	2154, 2182, 2197,
DEC	2308		2278, 2339, 2340,	Orion	2027, 2060	2283, 2319, 2325,
Decca	2312		2341, 2342, 2386,	Oritron	2198, 2204	2346, 2347, 2349,
Denon	2105, 2147, 2197,		2387, 2389, 2390,	P&B	2308	2372, 2381
	2286		2391	Pacific	2305	Sansui 2027, 2195, 2304,
Denver	2288, 2308, 2310,	Jwin	2148	Panasonic	2015, 2016, 2017,	2305, 2312
	2314	Kansai	2314		2036, 2037, 2038,	Sanyo 2139, 2195, 2212,
Denzel	2302	Kawasaki	2199		2039, 2040, 2041,	2374
Desay	2159	Kennex	2312		2042, 2043, 2074,	ScanMagic 2232
Diamond	2304, 2305	Kenwood	2123, 2197, 2270		2089, 2104, 2108,	Schaub Lorenz 2312
DiamondVision	2179, 2186	KeyPlug	2312		2112, 2120, 2131,	Schneider 2226
Disney	2078, 2088	Kiirro	2312		2132, 2197, 2205,	Scientific Labs 2305
DK Digital	2257	Kingavon	2308		2244, 2245, 2246,	Scott 2243, 2311
Dmtech	2226	Kiss	2302		2253, 2254, 2255,	Seeltech 2318
Dual	2302	KLH	2199, 2209		2292, 2321, 2324,	SEG 2240, 2302, 2305,
Durabrand	2218	Koda	2308		2327, 2328, 2329,	2313
DVX	2305	Koss	2095, 2198, 2204		2331, 2383, 2388	Sharp 2009, 2010, 2084,
Easy Home	2309	KXD	2309	Parasound	2151	2122, 2142, 2143,
Eclipse	2304	Landel	2221	peeKTON	2318	2144, 2181, 2190,
E-Dem	2318	Lasonic	2214	Philips	2026, 2061, 2062,	2228, 2262, 2375
Electrohome	2312	Lawson	2305		2075, 2090, 2094,	Shinsonic 2167
Elin	2312	Lecson	2303		2096, 2097, 2103,	Sigmathek 2309, 2318
Elta	2263, 2312, 2315	Lenco	2308, 2312, 2317		2110, 2126, 2180,	Silva 2310
Emerson	2196, 2211, 2219	Lenox	2203, 2218		2193, 2205, 2231,	Singer 2304, 2305
Enterprise	2211				2235, 2241, 2251,	Skymaster 2279, 2305

Skyworth	2310	Woxter	2315, 2318	Alcatel	3066	Movie Time	3031, 3063
Slim Art	2312	Xbox	2206, 2229	Americast	3046	Mr Zapp	3055
SM Electronic	2305	Xlogic	2305, 2312	Amstrad	3048, 3068	Multichoice	3057
Sonic Blue	2215	XMS	2312	Antronix	3019, 3020	Multitech	3045
Sontech	2316	Xoro	2300	Archer	3020	NEC	3018
Sony	2005, 2006, 2007, 2020, 2021, 2022, 2023, 2024, 2025, 2069, 2072, 2073, 2085, 2086, 2087, 2091, 2092, 2093, 2102, 2128, 2129, 2130, 2249, 2250, 2323, 2334, 2335, 2336, 2360, 2361, 2362, 2363, 2364, 2365, 2384	Yamada	2097, 2313, 2315	Arcon	3048	NET Brazil	3007
Soundmaster	2305	Yamaha	2000, 2001, 2002, 2003, 2011, 2018, 2019, 2036, 2106, 2197, 2273	AT&T	3013	Nokia	3051
Soundmax	2305	Yamakawa	2302, 2313	Axis	3048	Noos	3055
Spectra	2313	Yukai	2232	Bell South	3046	NSC	3031
Spectroniq	2155	Zenith	2080, 2141, 2205, 2211, 2215	Cable Vision	3014	Oak	3024
Standard	2305			Cabletenna	3019	Pace	3011, 3043, 3084
Star Cluster	2305			Cabletime	3058	Palladium	3049
Starmedia	2308, 2318			Cableview	3005	Panasonic	3034, 3036, 3040
Sungale	2158			Clearmaster	3045	Paragon	3040
Sunkai	2312			ClearMax	3045	Philips	3021, 3022, 3029, 3049, 3053, 3054, 3055
Superscan	2196			Clyde Cablevision	3059	Pioneer	3012, 3032, 3038, 3042, 3048, 3083, 3084
Supervision	2305			Colour Voice	3022	Popular Mechanics	3044
Sylvania	2094, 2180, 2189, 2196, 2219, 2224 2062, 2180			Comcast	3006, 3010, 3039	Proscan	3015, 3016
Symphonic	2305			Comcrypt	3057	Pulsar	3040
Synn	2305			Comtronics	3023	PVP Stereo Visual Matrix	3064 3040
T.D.E. Systems	2316			Contec	3024	Quasar	3040
Tatung	2083, 2312			Coolmax	3045	RadioShack	3041, 3045
TCM	2228, 2379			COX	3006	RCA	3005, 3036, 3076, 3077
Teac	2199, 2287, 2301, 2305			Cryptovision	3060	Realistic	3020
Tec	2310			Director	3006	Recoton	3044
Technics	2197			Eastern	3025	Regal	3028
Technika	2312, 2317			Everquest	3041	Regency	3025
Telefunken	2307			Fidelity	3048	Rembrandt	3016
Tensai	2312			Filmnet	3057	Runco	3040
Tevion	2228, 2305, 2311			Filmnet Cablecrypt	3061	Sagem	3055
Theta Digital	2207			Filmnet Comcrypt	3061	Samsung	3011, 3023, 3032, 3042
Thomson	2229, 2238, 2284, 2294			Finlux	3051	SAT	3048
Tokai	2302, 2310			Focus	3044	Scientific Atlanta	3003, 3004, 3011, 3012, 3013, 3062, 3078, 3079, 3080, 3081, 3082, 3083, 3084
Top Sucess	2318			Foxtel	3068	Signal	3026, 3041
Toshiba	2004, 2026, 2027, 2028, 2029, 2030, 2098, 2099, 2100, 2101, 2114, 2117, 2118, 2119, 2136, 2187, 2195, 2205, 2291, 2337, 2338, 2378			France Telecom	3054, 3055	Signature	3016
TRANScontinents	2313, 2317			Freebox	3069	Sony	3014, 3047
Transonic	2317			GC Electronics	3020	Sprucer	3036
Trio	2312			GE	3015, 3016	Standard Component	3033
Trutech	2160			GEC	3059	Starcom	3026, 3037, 3041, 3067
TruVision	2309			Gemini	3026, 3041	Stargate	3026, 3041
TSM	2318			General Instrument	3006, 3008, 3016, 3039, 3050, 3067, 3075	Starquest	3026, 3041
Umax	2315			Goldstar	3042	Supercable	3008
United	2317			Gooding	3049	Supermax	3045
Urban Concepts	2205			Grundig	3048, 3049	Tele+1	3057, 3061
US Logic	2167			Hamlin	3027, 3028	Telepiu	3057
Venturer	2199			Hirschmann	3051	Thomson	3000, 3009
Viewmaster	2318			Hitachi	3016	TIME WARNER	3006
Vocopro	2156			HomeChoice	3056	Tocom	3017
VocoStar	2157			Humax	3001, 3002, 3071	Torx	3067
Waitec	2318			ITT Nokia	3051	Toshiba	3040
Welltech	2300			Jasco	3041	Tristar	3045
Westinghouse	2109, 2168			Jerrold	3006, 3008, 3016, 3026, 3037, 3041, 3050, 3064, 3067, 3075	Tudi	3052
Wharfedale	2304, 2305			JVC	3049	Tusa	3026, 3041
				Kabel Deutschland	3043, 3073, 3074	TV86	3031
				Macab	3055	Unika	3019, 3020
				Magnavox	3029	United Cable	3037, 3064
				Maspro	3049	Universal	3019, 3020
				Matsui	3049	Universum	3049, 3051
				MegaCable	3039	V2	3045
				Memorex	3030, 3040	Videoway	3065
				Minerva	3049	View Star	3024, 3029, 3031
				Mnet	3057		
				Motorola	3006, 3008, 3010, 3013, 3039, 3072, 3075		

### Blu-ray Disc

LG	2115
Panasonic	2089, 2131, 2132
Pioneer	2134
Samsung	2035, 2127
Sharp	2142, 2143, 2144
Sony	2025
Yamaha	2018

### DVR

Bush	2060
Panasonic	2037, 2038, 2039, 2040, 2041, 2042
Philips	2061, 2062
Pioneer	2063, 2064, 2065, 2066, 2067
RCA	2059
Samsung	2035
Yamaha	2036

### DVD Recorder

Aspire	2140
Astar	2162
Broksonic	2192
Go Video	2135
Hitachi	2108
Insignia	2080
Irradio	2103
JVC	2054, 2055, 2056, 2057
LG	2107, 2115, 2141, 2188
Liteon	2121
Panasonic	2037, 2038, 2039, 2041, 2042, 2043, 2089, 2104, 2108, 2112
Philips	2090, 2096, 2097, 2126, 2193
Pioneer	2067, 2113
Pye	2194
Samsung	2034, 2082, 2138
Sansui	2027
Sanyo	2139
Sony	2022, 2023, 2024, 2085, 2086, 2087, 2102, 2128, 2129, 2130
Sylvania	2189
Toshiba	2030, 2099, 2100, 2101, 2114, 2117, 2118, 2119
Yamaha	2106

### Cable

ABC	3004, 3015, 3016, 3017, 3037, 3040, 3067, 3080, 3081
ADB	3070
Adelphia	3003



Viewmaster	3045	Condor	4074, 4090, 4137	Fuba	4074, 4083, 4090,	Lasat	4074, 4088, 4090,
Vision	3045	Connexions	4074, 4092		4092, 4093, 4101,		4100, 4133, 4134,
Visiopass	3051, 3054, 3055	Conrad	4074, 4133, 4136,		4133		4137
Vortex View	3045		4137	Galaxis	4074, 4087, 4090,	Lasonic	4062
Wittenberg	3048	Conrad Electronic	4137, 4139		4091, 4096, 4098,	Lenco	4074, 4083, 4099,
Zenith	3035, 3040, 3046	Contec	4096		4133, 4140		4133, 4137, 4139
Zentek	3044	Coolsat	4050	GE	4015, 4016, 4061,	Leng	4095
		Cosat	4098		4151	Lennox	4098
<b>Sattelite</b>		Coship	4063	General Instrument		Lenson	4136
AB Sat	4138, 4139	Crown	4089		4027, 4065	Lexus	4103
AccessHD	4058	Daeryung	4092	GMI	4089	LG	4053, 4057, 4099
ADB	4142	Daewoo	4107, 4139	GOI	4039	Lifesat	4074, 4090, 4134,
AGS	4138	DDC	4085	Goldbox	4135		4139
Akai	4101, 4103	Delega	4085	GoldStar	4099	Lifetec	4090
Alba	4083, 4084, 4085,	Dew	4096	Goodmans	4079, 4080, 4084	Lorenzen	4137
	4086, 4108, 4139	Diamond	4097	Goodmind	4061	Lorraine	4099
Aldes	4085, 4087, 4088	Digitality	4137	Grandin	4077	Lupus	4074, 4090
Allsat	4098, 4101, 4103	Digital Stream	4059	Grothusen	4083, 4099	Luxor	4136
Allsonic	4074, 4087, 4090	DIRECTV	4017, 4018, 4020,	Grundig	4084, 4086, 4093,	Lyonnaise	4102
Alltech	4139		4021, 4022, 4024,		4113, 4129, 4136,	Macab	4102
Alpha	4103		4037, 4038, 4040,		4140	Magnavox	4045, 4055
Alpha Digital	4058		4041, 4043, 4045,	Hänsel & Gretel	4137	Manata	4077, 4138, 4139
Alphastar	4031		4057, 4106, 4143,	Hantor	4083, 4095	Manhattan	4084, 4088, 4098,
Amitronica	4139		4144, 4145, 4146,	Hanuri	4088		4138
Amstrad	4089, 4113, 4136,		4147, 4148, 4149,	Hauppauge	4126	Marantz	4101
	4139		4150, 4151, 4152,	Heliocom	4137	Mascom	4088
Anglo	4139		4153, 4154, 4155,	Helium	4137	Maspro	4084, 4139
Ankaro	4074, 4087, 4090,		4156, 4157	Hinari	4085	Matsui	4138
	4139	Discoverer	4134	Hirschmann	4074, 4093, 4128,	Max	4137
Anttron	4083, 4086	Discovery	4138		4136, 4137, 4138	Mediabox	4135
Apollo	4083	Diseqc	4138	Hisawa	4095	Mediamarkt	4089
Armstrong	4089, 4103	Dish Network	4011, 4012, 4013,	Hisense	4066	Mediasat	4091, 4135, 4136
Artec	4054		4014, 4019, 4039,	Hitachi	4032, 4084, 4149,	Medion	4074, 4090, 4139
Asat	4101, 4103		4064		4153	Medison	4139
ASLF	4139	Dishpro	4039, 4064	Homecast	4005, 4006, 4007	Mega	4101, 4103
Astacom	4138	Distrisat	4103	Houston	4098	Memorex	4045
Astra	4089, 4091, 4100,	Ditrisatrad	4098	HTS	4039	Metronic	4077, 4078, 4083,
	4137, 4139	DNT	4092, 4101, 4103	Hughes	4018, 4022, 4144,		4086, 4087, 4088,
Astro	4074, 4086, 4088,	Drake	4026		4146, 4150, 4152		4139
	4090, 4093, 4135,	DStv	4140	Hughes Network Systems		Metz	4093
	4136, 4137	Dune	4074		4021	Micro electronic	4136, 4137, 4139
AudioTon	4086, 4098	Echostar	4011, 4019, 4039,	Humax	4051, 4075, 4076,	Micro Technology	4139
Aurora	4140		4064, 4092, 4139		4110	MicroGem	4056
Austar	4140	Einhell	4083, 4087, 4089,	Huth	4087, 4089, 4094,	Micromaxx	4074, 4090
Axiel	4138		4136, 4139		4095, 4096, 4098,	Microstar	4090
Axis	4074, 4090, 4091,	Elap	4138, 4139		4137, 4141	Microtec	4139
	4096	Elekta	4088	Hypson	4077	Minerva	4093
Best	4074, 4090	Elsat	4139	Ilo	4066	Mitsubishi	4084, 4093, 4152
Blaupunkt	4093	Elta	4074, 4083, 4090,	Imex	4077	Mitsumi	4100
Blue Sky	4139		4098, 4101, 4103	Innovation	4090	Morgan's	4089, 4100, 4101,
Boca	4089, 4100, 4105,	Emanon	4083	Insignia	4057		4103, 4139
	4139	Emme Esse	4074, 4090	Intertronic	4089	Motorola	4008, 4009, 4010,
Boston	4138	Engel	4139	Intervision	4098, 4137		4065
Brain Wave	4095	Ep Sat	4084	ITT Nokia	4084	Multichoice	4140
Broadcast	4094	EURIEULT	4077	Jerrold	4065	Multitec	4134
Broco	4139	Eurodec	4102	Johansson	4095	Muratto	4099
BSkyB	4113, 4123	Europa	4103, 4136, 4137	JOK	4138	Mysat	4139
BT	4138	Europhon	4137	JSR	4098	Navex	4095
Bubu Sat	4139	Eurosat	4089	JVC	4011, 4019, 4039,	Neuhaus	4091, 4098, 4136,
Bush	4084, 4127	Eurosky	4074, 4089, 4090,		4079		4137, 4139
Cambridge	4136		4133, 4136, 4137	Kamm	4139	Neusat	4139
Canal Satellite	4135	Eurostar	4089, 4133, 4137	Kathrein	4093, 4101, 4103,	Next Level	4065
Canal+	4135	Eutelsat	4139		4109, 4112, 4120,	NextWave	4141
CaptiveWorks	4049	Exator	4083, 4086		4133, 4138, 4139	Nikko	4089, 4139
Channel Master	4060, 4085	Expressvu	4039	Kathrein Eurostar	4133	Nokia	4084, 4122
Chaparral	4025	Fenner	4074, 4134, 4139	Klap	4138	Nordmende	4083, 4084, 4085,
CHEROKEE	4138	Ferguson	4084, 4102, 4132	Konig	4137		4088, 4102
Chess	4134, 4139	Fidelity	4136	Kosmos	4099	Nova	4140
CityCom	4084, 4133, 4137	Finlandia	4084	KR	4086	Novis	4095
Clatronic	4095	Finlux	4084	Kreiselmeyer	4093	Oceanic	4097
CNT	4088	FinnSat	4096, 4102	K-SAT	4139	Octagon	4083, 4086, 4096
Comag	4000, 4001, 4002,	Flair Mate	4139	Kyostar	4083	Okano	4089
	4003, 4004	Foxtel	4140	L&S Electronic	4074	Optex	4098
Commlink	4087	Freecom	4083, 4099, 4136			Optus	4135, 4140, 4141
Comtech	4096	FTEmaximal	4074, 4139				

Orbitech	4083, 4134, 4135, 4136	Satcom	4094, 4137	Tivax	4058
OSat	4086	Satec	4139	Tivo	4150
Otto Versand	4093	Satelco	4074	Tokai	4103
Pace	4084, 4093, 4113, 4121, 4125, 4138	Satford	4094	Tonna	4084, 4094, 4098, 4136, 4139
Pacific	4097	Satmaster	4094	Toshiba	4144, 4152, 4153
Packsat	4138	Satplus	4134	Triad	4099
Palcom	4085	Schneider	4090, 4134, 4138	Triasat	4136
Palladium	4089, 4136	Schwaiger	4097, 4134, 4137	Triax	4093, 4133, 4136, 4139
Palsat	4134, 4136	SCS	4133	Turnsat	4139
Panasat	4140	Seemann	4089, 4091, 4092	Tvonic	4132
Panasonic	4043, 4044, 4046, 4084, 4113, 4118, 4143, 4148	SEG	4074, 4083, 4090, 4095	Twiner	4077, 4139
Panda	4084, 4137	Seleco	4098	UEC	4140
Pansat	4047	Servi Sat	4077, 4139	Uher	4134
Patriot	4138	Siemens	4093	UltimateTV	4020
Paysat	4045	Silva	4099	Uniden	4029, 4045
PCT	4060	Skantin	4139	Unisat	4089, 4096, 4103
Philco	4055	Skardin	4091	Unitor	4095
Philips	4021, 4022, 4045, 4084, 4101, 4103, 4111, 4115, 4135, 4138, 4150, 4152, 4153, 4155, 4156	Skinsat	4136	Universum	4093, 4133, 4137
Phoenix	4096	SKR	4139	US Digital	4066
Phonotrend	4084, 4087, 4098	Skymaster	4067, 4068, 4087, 4134, 4139	Variosat	4093
Pioneer	4124, 4135	Skymax	4101, 4103	Vega	4074
Polsat	4102	SkySat	4134, 4136, 4137, 4139	Ventana	4101, 4103
Predki	4095	Skyvision	4098	Viewsat	4048
Premiere	4098, 4135	SM Electronic	4134, 4139	Visiosat	4095, 4098, 4138, 4139
Priesner	4089	Smart	4133, 4139	Voom	4065
Primestar	4030	Sony	4017, 4020, 4135	Vortec	4083
Profile	4138	SR	4089, 4100	Welltech	4134
Promax	4084	Star Choice	4065	WeTeKom	4134, 4136
Prosat	4085, 4087	Starland	4139	Wevasat	4084
Proscan	4015, 4016, 4040, 4151	Starring	4095	Wewa	4084
Protek	4097	Start Trak	4083	Winersat	4095
Proton	4066	Strong	4074, 4083, 4086, 4090, 4099, 4140	Wisi	4084, 4092, 4093, 4136, 4137
Provision	4088	STS	4033	Woorisat	4088
Quadral	4074, 4085, 4087, 4090, 4138	STVI	4077	Worldsat	4138
Quelle	4093, 4133, 4137	Sumida	4089	Xrypton	4074
Quiero	4102	Sunny Sound	4074	XSat	4139
RadioShack	4065	Sunsat	4139	Zehnder	4074, 4088, 4090, 4131, 4133
Radiola	4101, 4103	Sunstar	4074, 4089, 4100	Zenith	4052, 4057, 4145
Radix	4092, 4119	Supermax	4141	Zodiac	4086
Rainbow	4086	Tandberg	4102		
RCA	4015, 4016, 4034, 4035, 4036, 4037, 4038, 4040, 4151, 4157	Tandy	4086		
Realistic	4028	Tantec	4084		
Redpoint	4091	TCM	4090		
Redstar	4074, 4090	Techniland	4094		
RFT	4087, 4101, 4103	TechniSat	4071, 4072, 4073, 4092, 4103, 4116, 4117, 4134, 4135, 4136		
Roadstar	4139	Technology	4140		
Roch	4077	Technosat	4141		
Rover	4074, 4139	Technowelt	4137		
Saba	4088, 4133, 4137, 4138	Teco	4089, 4100		
Sabre	4084	Telanor	4085		
Sagem	4069, 4102	Telasat	4133, 4137		
Sakura	4096	Telecom	4139		
Samsung	4018, 4021, 4023, 4041, 4042, 4081, 4082, 4083, 4114, 4150, 4154	Telefunken	4067, 4083, 4138		
SAT	4085, 4136	Teleka	4086, 4089, 4092, 4136, 4137		
Sat Cruiser	4141	Telemaster	4088		
Sat Partner	4083, 4086, 4088, 4095, 4099, 4136	Telesat	4137		
Sat Team	4139	Telestar	4134, 4135, 4136		
		Televs	4084, 4136		
		Telewire	4098		
		Tempo	4141		
		Tevion	4090, 4139		
		Thomson	4070, 4084, 4102, 4104, 4130, 4133, 4135, 4137, 4138, 4139		
		Thorens	4097		
		Thorn	4084		

---

## CD

Yamaha 5000, 5013

---

## CD Recoder

Yamaha 5001

---

## MD

Yamaha 5002, 5003, 5004

---

## Tape

Yamaha 5005, 5006

---

## Tuner

Yamaha 5007, 5008, 5009, 5010, 5014, 5015, 5016, 5017, 5018

---

## USB

Yamaha 5012, 5021

---

## DOCK

Yamaha 5011, 5022

---

## LD

Yamaha 2002



