



Portable Grand™

DGX-500

DGX-300

Owner's Manual



SPECIAL MESSAGE SECTION

This product utilizes batteries or an external power supply (adapter). DO NOT connect this product to any power supply or adapter other than one described in the manual, on the name plate, or specifically recommended by Yamaha.

This product should be used only with the components supplied or; a cart, rack, or stand that is recommended by Yamaha. If a cart, etc., is used, please observe all safety markings and instructions that accompany the accessory product.

SPECIFICATIONS SUBJECT TO CHANGE:

The information contained in this manual is believed to be correct at the time of printing. However, Yamaha reserves the right to change or modify any of the specifications without notice or obligation to update existing units.

This product, either alone or in combination with an amplifier and headphones or speaker/s, may be capable of producing sound levels that could cause permanent hearing loss. DO NOT operate for long periods of time at a high volume level or at a level that is uncomfortable. If you experience any hearing loss or ringing in the ears, you should consult an audiologist. **IMPORTANT:** The louder the sound, the shorter the time period before damage occurs.

NOTICE:

Service charges incurred due to a lack of knowledge relating to how a function or effect works (when the unit is operating as designed) are not covered by the manufacturer's warranty, and are therefore the owners responsibility. Please study this manual carefully and consult your dealer before requesting service.

ENVIRONMENTAL ISSUES:

Yamaha strives to produce products that are both user safe and environmentally friendly. We sincerely believe that our products and the production methods used to produce them, meet these goals. In keeping with both the letter and the spirit of the law, we want you to be aware of the following:

Battery Notice:

This product MAY contain a small non-rechargeable battery which (if applicable) is soldered in place. The average life span of this type of battery is approximately five years. When replacement becomes necessary, contact a qualified service representative to perform the replacement.

This product may also use "household" type batteries. Some of these may be rechargeable. Make sure that the battery being charged is a rechargeable type and that the charger is intended for the battery being charged.

When installing batteries, do not mix batteries with new, or with batteries of a different type. Batteries MUST be installed correctly. Mismatches or incorrect installation may result in overheating and battery case rupture.

Warning:

Do not attempt to disassemble, or incinerate any battery. Keep all batteries away from children. Dispose of used batteries promptly and as regulated by the laws in your area. Note: Check with any retailer of household type batteries in your area for battery disposal information.

Disposal Notice:

Should this product become damaged beyond repair, or for some reason its useful life is considered to be at an end, please observe all local, state, and federal regulations that relate to the disposal of products that contain lead, batteries, plastics, etc. If your dealer is unable to assist you, please contact Yamaha directly.

NAME PLATE LOCATION:

The name plate is located on the bottom of the product. The model number, serial number, power requirements, etc., are located on this plate. You should record the model number, serial number, and the date of purchase in the spaces provided below and retain this manual as a permanent record of your purchase.

Model

Serial No.

Purchase Date

PLEASE KEEP THIS MANUAL

FCC INFORMATION (U.S.A.)

1. IMPORTANT NOTICE: DO NOT MODIFY THIS UNIT!

This product, when installed as indicated in the instructions contained in this manual, meets FCC requirements. Modifications not expressly approved by Yamaha may void your authority, granted by the FCC, to use the product.

2. IMPORTANT: When connecting this product to accessories and/or another product use only high quality shielded cables. Cable/s supplied with this product MUST be used. Follow all installation instructions. Failure to follow instructions could void your FCC authorization to use this product in the USA.

3. NOTE: This product has been tested and found to comply with the requirements listed in FCC Regulations, Part 15 for Class "B" digital devices. Compliance with these requirements provides a reasonable level of assurance that your use of this product in a residential environment will not result in harmful interference with other electronic devices. This equipment generates/uses radio frequencies and, if not installed and used according to the instructions found in the users manual, may cause interference harmful to the operation of other electronic devices. Compliance with FCC regulations does not guarantee

that interference will not occur in all installations. If this product is found to be the source of interference, which can be determined by turning the unit "OFF" and "ON", please try to eliminate the problem by using one of the following measures:

Relocate either this product or the device that is being affected by the interference.

Utilize power outlets that are on different branch (circuit breaker or fuse) circuits or install AC line filter/s.

In the case of radio or TV interference, relocate/reorient the antenna. If the antenna lead-in is 300 ohm ribbon lead, change the lead-in to coaxial type cable.

If these corrective measures do not produce satisfactory results, please contact the local retailer authorized to distribute this type of product. If you can not locate the appropriate retailer, please contact Yamaha Corporation of America, Electronic Service Division, 6600 Orangethorpe Ave, Buena Park, CA90620

The above statements apply ONLY to those products distributed by Yamaha Corporation of America or its subsidiaries.

* This applies only to products distributed by YAMAHA CORPORATION OF AMERICA.

(class B)

OBSERVERA!

Apparaten kopplas inte ur växelströmskällan (nätet) så länge som den är ansluten till vägguttaget, även om själva apparaten har stängts av.

ADVARSSEL: Netspændingen til dette apparat er IKKE afbrudt, så længe netledningen sidder i en stikkontakt, som er tændt — også selv om der er slukket på apparatets afbryder.

VAROITUS: Laitteen toisiopiiriin kytketty käyttökytin ei irroita koko laitetta verkosta.

(standby)

Entsorgung leerer Batterien (nur innerhalb Deutschlands)

Leisten Sie einen Beitrag zum Umweltschutz. Verbrauchte Batterien oder Akkumulatoren dürfen nicht in den Hausmüll. Sie können bei einer Sammelstelle für Altbatterien bzw. Sondermüll abgegeben werden. Informieren Sie sich bei Ihrer Kommune.

(battery)

PRECAUTIONS

PLEASE READ CAREFULLY BEFORE PROCEEDING

* Please keep this manual in a safe place for future reference.



WARNING

Always follow the basic precautions listed below to avoid the possibility of serious injury or even death from electrical shock, short-circuiting, damages, fire or other hazards. These precautions include, but are not limited to, the following:

Power supply/AC power adaptor

- Only use the voltage specified as correct for the instrument. The required voltage is printed on the name plate of the instrument.
- Use the specified adaptor (PA-5D, PA-5C or an equivalent recommended by Yamaha) only. Using the wrong adaptor can result in damage to the instrument or overheating.
- Check the electric plug periodically and remove any dirt or dust which may have accumulated on it.
- Do not place the AC adaptor cord near heat sources such as heaters or radiators, and do not excessively bend or otherwise damage the cord, place heavy objects on it, or place it in a position where anyone could walk on, trip over, or roll anything over it.

Do not open

- Do not open the instrument or attempt to disassemble the internal parts or modify them in any way. The instrument contains no user-serviceable parts. If it should appear to be malfunctioning, discontinue use immediately and have it inspected by qualified Yamaha service personnel.

Water warning

- Do not expose the instrument to rain, use it near water or in damp or wet conditions, or place containers on it containing liquids which might spill into any openings.
- Never insert or remove an electric plug with wet hands.

Fire warning

- Do not put burning items, such as candles, on the unit. A burning item may fall over and cause a fire.

If you notice any abnormality

- If the AC adaptor cord or plug becomes frayed or damaged, or if there is a sudden loss of sound during use of the instrument, or if any unusual smells or smoke should appear to be caused by it, immediately turn off the power switch, disconnect the adaptor plug from the outlet, and have the instrument inspected by qualified Yamaha service personnel.



CAUTION

Always follow the basic precautions listed below to avoid the possibility of physical injury to you or others, or damage to the instrument or other property. These precautions include, but are not limited to, the following:

Power supply/AC power adaptor

- When removing the electric plug from the instrument or an outlet, always hold the plug itself and not the cord.
- Unplug the AC power adaptor when not using the instrument, or during electrical storms.
- Do not connect the instrument to an electrical outlet using a multiple-connector. Doing so can result in lower sound quality, or possibly cause overheating in the outlet.

Battery

- Always make sure all batteries are inserted in conformity with the +/- polarity markings. Failure to do so might result in overheating, fire, or battery fluid leakage.
- Always replace all batteries at the same time. Do not use new batteries together with old ones. Also, do not mix battery types, such as alkaline batteries with manganese batteries, or batteries from different makers, or different types of batteries from the same maker, since this can cause overheating, fire, or battery fluid leakage.
- Do not dispose of batteries in fire.
- Do not attempt to recharge batteries that are not intended to be charged.

- When the batteries run out, or if the instrument is not to be used for a long time, remove the batteries from the instrument to prevent possible leakage of the battery fluid.
- Keep batteries away from children.
- If the batteries do leak, avoid contact with the leaked fluid. If the battery fluid should come in contact with your eyes, mouth, or skin, wash immediately with water and consult a doctor. Battery fluid is corrosive and may possibly cause loss of sight or chemical burns.

Location

- Do not expose the instrument to excessive dust or vibrations, or extreme cold or heat (such as in direct sunlight, near a heater, or in a car during the day) to prevent the possibility of panel disfiguration or damage to the internal components.
- Do not use the instrument in the vicinity of a TV, radio, stereo equipment, mobile phone, or other electric devices. Otherwise, the instrument, TV, or radio may generate noise.
- Do not place the instrument in an unstable position where it might accidentally fall over.
- Before moving the instrument, remove all connected adaptor and other cables.
- Use only the stand specified for the instrument. When attaching the stand or rack, use the provided screws only. Failure to do so could cause damage to the internal components or result in the instrument falling over.

Connections

- Before connecting the instrument to other electronic components, turn off the power for all components. Before turning the power on or off for all components, set all volume levels to minimum. Also, be sure to set the volumes of all components at their minimum levels and gradually raise the volume controls while playing the instrument to set the desired listening level.

Maintenance

- When cleaning the instrument, use a soft, dry cloth. Do not use paint thinners, solvents, cleaning fluids, or chemical-impregnated wiping cloths.

Handling caution

- Do not insert a finger or hand in any gaps on the instrument.
- Never insert or drop paper, metallic, or other objects into the gaps on the panel or keyboard. If this happens, turn off the power immediately and unplug the power cord from the AC outlet. Then have the instrument inspected by qualified Yamaha service personnel.
- Do not place vinyl, plastic or rubber objects on the instrument, since this might discolor the panel or keyboard.

- Do not rest your weight on, or place heavy objects on the instrument, and do not use excessive force on the buttons, switches or connectors.
- Do not operate the instrument for a long period of time at a high or uncomfortable volume level, since this can cause permanent hearing loss. If you experience any hearing loss or ringing in the ears, consult a physician.

Saving data

Saving and backing up your data

For instruments with RAM that retains data by using dry cell batteries or a power adaptor

- As long as dry cell batteries are installed or the power adaptor is connected, the instrument retains the internal data when the power is turned off. If you remove the batteries and disconnect the adaptor, the data will be lost. Save important data to a floppy disk/external media such as the Yamaha MDF3 MIDI data filer. Keep the power adaptor connected while you replace the batteries to prevent loss of data.

Backing up the floppy disk

- To protect against data loss through media damage, we recommend that you save your important data onto two floppy disks.

Yamaha cannot be held responsible for damage caused by improper use or modifications to the instrument, or data that is lost or destroyed.

Always turn the power off when the instrument is not in use.

When using a power adaptor, even when the power switch is in the "STANDBY" position, electricity is still flowing to the instrument at the minimum level. When you are not using the instrument for a long time, make sure you unplug the AC power adaptor from the wall AC outlet.

Make sure to discard used batteries according to local regulations.

- The illustrations and LCD screens as shown in this owner's manual are for instructional purposes only, and may be different from the ones on your instrument.
- Unless otherwise indicated, the example panel control illustrations, Keyboard illustrations and LCD screenshots are taken from the DGX-500.

● Three of the demo-songs (or compositions) included in this keyboard are as follows:

Composition Title: Just The Way You Are
Composer's Name: Joel 0273671
Copyright Owner's Name: EMI MUSIC PUBLISHING LTD

Composition Title: Ribbon In The Sky
Composer's Name: Wonder 0404386
Copyright Owner's Name: Black Bull Music / Jobete Music Co Ltd

Composition Title: Look Of Love
Composer's Name: Bacharach/David 0093316
Copyright Owner's Name: Screen Gems - EMI Music Ltd

CAUTION: All Rights Reserved, Unauthorized copying, public performance and broadcasting are strictly prohibited regarding the above three demo-songs.

● COPYRIGHT NOTICE

This product incorporates and bundles computer programs and contents in which Yamaha owns copyrights or with respect to which it has license to use others' copyrights. Such copyrighted materials include, without limitation, all computer software, styles files, MIDI files, WAVE data and sound recordings. Any unauthorized use of such programs and contents outside of personal use is not permitted under relevant laws. Any violation of copyright has legal consequences. **DON'T MAKE, DISTRIBUTE OR USE ILLEGAL COPIES.**

● Trademarks

- Apple and Macintosh are trademarks of Apple Computer, Inc., registered in the U.S. and other countries.
- Windows is the registered trademark of Microsoft[®] Corporation.

All other trademarks are the property of their respective holders.

Congratulations on your purchase of the Yamaha DGX-500/300 Portable Grand™ !

You now own a portable keyboard that combines advanced functions, great sound and exceptional ease-of-use in a highly compact package. Its outstanding features also make it a remarkably expressive and versatile instrument.

Read this Owner's Manual carefully while playing your new DGX-500/300 in order to take full advantage of its various features.

Main Features

The DGX-500/300 is a sophisticated yet easy-to-use keyboard with the following features and functions:

■ MUSIC DATABASE page 53

The DGX-500/300 has an advanced, easy-to-use Music Database feature that automatically selects the style, voice, and effect settings for playing in a specific type of music. This can be a big help if you know what genre of music you want to play, but you don't know what settings to make. Just select the genre, and the DGX-500/300 takes care of the rest!

■ Disk Drive page 73

The DGX-500/300 also features a convenient floppy disk drive letting you load and save your own original User Songs or load the Style Files. The DGX-500/300 is also compatible with a wide variety of disk formats, allowing you to play back song data on commercially available GM, DOC, and Clavinova Disklavier Piano Soft disks. It also allows you to save and play back Standard MIDI File (SMF) format 0 data, making it possible to use song data with your favorite sequencer or sequencing software.



■ Powerful Speaker System

The built-in stereo amplifier/speaker system of the DGX-500/300 with a special Bass Boost feature — provides exceptionally powerful, high-quality sound, letting you hear the full dynamic range of the DGX-500/300's authentic voices.

■ GM System Level 1

"GM System Level 1" is an addition to the MIDI standard which ensures that any GM-compatible music data can be accurately played by any GM-compatible tone generator, regardless of manufacturer. The GM mark is affixed to all software and hardware products that support GM System Level.



■ XGlite

As its name implies, "XGlite" is a simplified version of Yamaha's high-quality XG tone generation format. Naturally, you can play back any XG song data using an XGlite tone generator. However, keep in mind that some songs may play back differently compared to the original data, due to the reduced set of control parameters and effects.



Other powerful features include:

- The advanced **Yamaha Education Suite** — a special set of learning tools that make it easy and fun to master the keyboard. These tools include **Lesson**, which guides you through the parts of a song just as a teacher would, **Grade**, which evaluates your practice sessions and rates your performance, and **Dictionary**, which teaches you how to play chords.
- Instant **Portable Grand** function, for automatically configuring the DGX-500/300 for optimum piano play. Includes an authentic Stereo Sampled Piano voice.
- **619** exceptionally **realistic and dynamic voices**, utilizing digital recordings of actual instruments.
- Special **Split voices**, with two different voices playable from separate sections of the keyboard.
- **12** different **Drum Kit voices**, with individual drum and percussion sounds on each key.
- High-quality **Reverb, DSP, and Harmony effects** for enhancing the sound of the voices — and your performance.
- **135 auto accompaniment styles**, each with Intro, Main A and B, and Ending sections. An Auto Fill function adds dynamic fills when switching sections.
- Powerful, easy-to-use **song recording** operations, for recording and playing back up to five of your original songs.
- **Registration Memory** presets for storing all of the DGX-500/300's panel settings to a single button for instant and automatic recall.
- **One Touch Setting** function for automatically calling up an appropriate voice to match the style or song you select.
- **Touch Response** and **Dynamic Filter** that give you extraordinarily expressive control over the voices. They automatically change both the volume and tone according to your playing strength — just like a real musical instrument!

Contents

Panel Controls and Terminals	8	Selecting and Playing Songs	57
Setting Up	10	• Selecting and Playing a Song	57
• Power Requirements	10	• A-B Repeat	58
• Turning On the Power	11	• Melody Voice Change	59
• Accessory Jacks	11	• Changing the Tempo	60
		• Adjusting the Song Volume	61
Quick Guide	12	Song Recording	62
Step 1 Voices	12	• Recording a User Song	62
Step 2 Songs	14	• Song Clear	65
Step 3 Music Database	16	• Track Clear	66
Step 4 Lesson	18	Song Lesson	67
		• Using the Lesson Feature	67
Panel Display Indications	20	• Select the Lesson Track	69
Portable Grand	22	• Lesson 1 — Timing	69
• Playing the Portable Grand	22	• Lesson 2 — Waiting	70
• Using the Metronome	22	• Lesson 3 — Minus One	70
Playing Voices	24	• Lesson 4 — Both Hands	71
• Playing a Voice	24	• Grade	72
• Dual Voice	26	Disk Operations	73
Main Voice and Dual Voice settings	27	• Disk Song Playback	75
• Split Voice	28	• Save	76
• One Touch Setting	28	Saving files in SMF Format 0	78
• Transpose and Tuning	29	• Load	79
• Pitch Bend Range	31	• Utility – Delete	80
• Touch and Touch Sensitivity	32	• Utility – Formatting an Unformatted Disk	81
Effects	33	• Utility – Formatting a Previously Formatted Disk	82
• Reverb	33	MIDI Functions	83
• DSP	34	• What Is MIDI?	83
• Harmony	35	• Connecting to a Personal Computer	85
Selecting and Playing Styles	38	• Local Control	86
• Selecting a Style	38	• Using Initial Setup Send with a Sequencer	87
• Playing the styles	39	• External Clock	88
• Sync Stop	43	Troubleshooting	89
• Changing the Tempo	44	Data Backup & Initialization	90
• MAIN/AUTO FILL (Main A/B and Fill-ins)	45	Voice List	91
• Adjusting the Accompaniment Volume	46	Style List	98
• Using Auto Accompaniment — Multi Fingering	47	Music Database List	99
• Setting the Split Point	49	Drum Kit List	100
• Dictionary	50	MIDI Implementation Chart	102
Using the Music Database	53	Effect map	104
• Data stored by the Music Database	54	Keyboard Stand Assembly (DGX-500 only)	105
Registration Memory	55	Specifications	108
• Registration Memory Presets	55	Index	109
• Recording a Registration Memory Preset	55		
• Recalling a Registration Memory Preset	56		



Panel Controls and Terminals

■ Front Panel

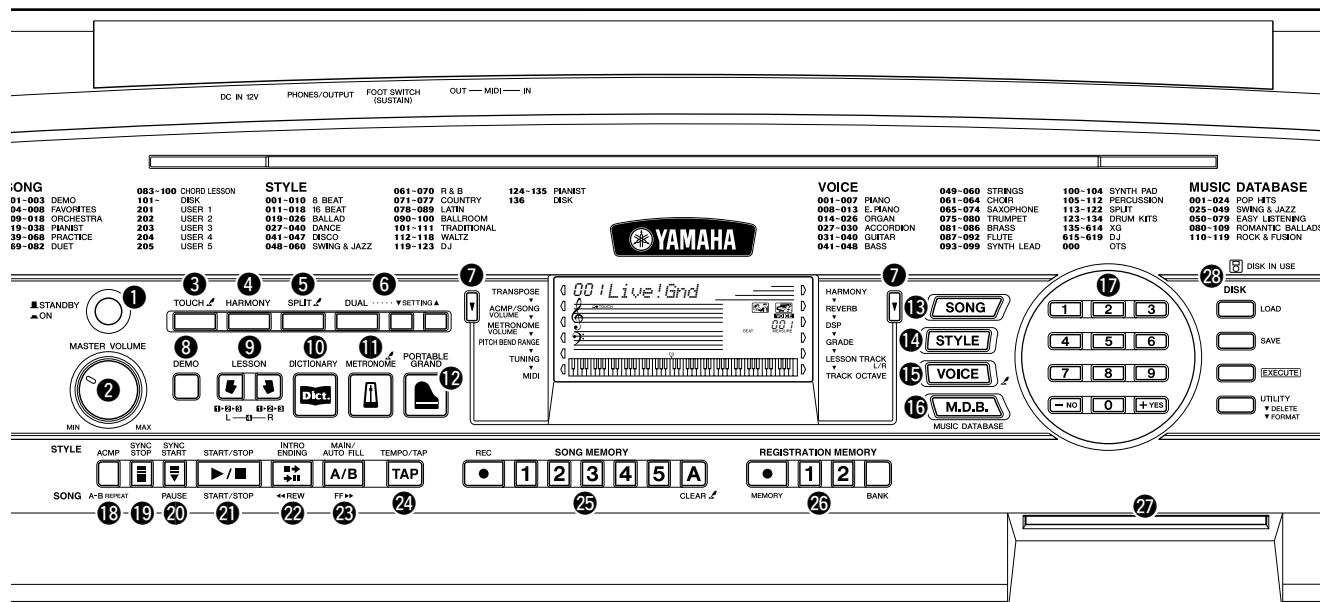

1 Power switch ([STANDBY/ON])

2 [MASTER VOLUME] dial

This determines the overall volume of the DGX-500/300.

3 [TOUCH] button

This turns the Touch function on and off. (See page 32.) Holding down this button allows you to adjust the Touch Sensitivity setting. (See page 32.)

4 [HARMONY] button

This turns the Harmony effect on and off. (See page 35.)

5 [SPLIT] button

This instantly calls up the last selected Split Voice. (See page 28.)

6 [DUAL] and [SETTING ▲/▼] buttons

Use the [DUAL] button to turn the Dual voice on or off. Use the [SETTING ▲/▼] buttons to set the parameters related to the Main and Dual voices. (See page 26.)

7 Overall (left, right) buttons

These two buttons on either side of the LCD let you call up various functions, settings, and operations of the DGX-500/300, including effects, transpose, tuning, and MIDI. (See page 20.)

8 [DEMO] button

This is used to play the Demo songs. (See page 14.)

9 LESSON [L] (Left) and [R] (Right) buttons

These call up the Lesson exercises for the corresponding hand (left or right) for the selected song. (See page 68.)

10 [DICTIONARY] button

This calls up the Dictionary function (page 50).

11 [METRONOME] button

This turns the metronome on and off. (See page 22.) Holding down this button allows you to set the Time Signature.

12 [PORTABLE GRAND] button

This instantly calls up the Grand Piano voice. (See page 12.)

13 [SONG] button

This is for enabling song selection. (See page 57.)

14 [STYLE] button

This is for enabling style selection. (See page 38.)

15 [VOICE] button

This is for enabling voice selection. (See page 24.) Holding down this button calls up the Melody Voice Change function. (See page 59.)

16 [M.D.B.] (MUSIC DATABASE) button

This calls up the optimum panel settings for selected music genre. (See page 53.)

17 Numeric keypad, [+ / YES] and [- / NO] buttons

These are used for selecting songs, voices, styles, and M.D.B.. (See pages 25.) They are also used for adjusting certain settings and answering certain display prompts.

18 [ACMP] / [A-B REPEAT] button

When the Style mode is selected, this turns the auto accompaniment on and off. (See page 39.) This also determines the Accompaniment Split Point. In the Song mode, this calls up the A-B Repeat function. (See page 58.)

19 [SYNC STOP] button

This turns the Sync Stop function on and off. (See page 43.)

20 [SYNC START] / [PAUSE] button

This turns the Sync Start function on and off. (See page 40.) In the Song mode, it is used to temporarily pause song playback. (See page 59.)

21 [START/STOP] button

When the Style mode is selected, this alternately starts and stops the style. (See page 39.) In the Song mode, this alternately starts and stops song playback. (See page 58.)

22 [INTRO ENDING] / [◀◀REW] button

When the Style mode is selected, this is used to control the Intro and Ending functions. (See page 39.) When the Song mode is selected, this is used as a “rewind” control, or move the song playback point back toward the beginning.

23 [MAIN/AUTO FILL] / [FF▶▶] button

When the Style mode is selected, these are used to change auto accompaniment sections and control the Auto Fill function. (See page 45.) When the Song mode is selected, this is used as a “fast forward” control, or move the song playback point toward the end.

24 [TEMPO/TAP] button

This button is used to call up the Tempo setting, letting you set the Tempo with the numeric keypad or [+]/[-] buttons. (See page 22.) It also allows you to tap out the tempo and automatically start a selected song or style at that tapped speed. (See page 40.)

25 [SONG MEMORY] buttons

These buttons ([REC], [1] - [5], [A]) are used for song recording, letting you record up to six different tracks of a song (including a special Accompaniment track). (See page 63.) They are also used for clearing recorded data of all or specific tracks of a User song. (See pages 65, 66.)

26 REGISTRATION MEMORY buttons

These are used for selecting and recording the Registration Memory presets. (See page 55.)

27 Disk Drive

This is for insertion of floppy disks, for loading and saving of data. (See page 73.)

28 Disk control buttons

These buttons are used for disk drive control.

29 [PITCH BEND] wheel

This is used for raising or lowering the pitch of the voices as you play. The pitch bend range of the wheel can also be set. (See page 31.)

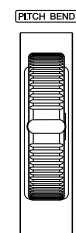

■ Rear Panel

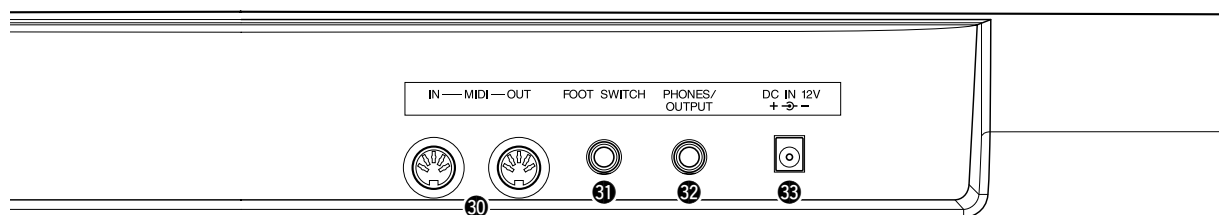

30 MIDI IN, OUT terminals

These are for connection to other MIDI instruments and devices. (See page 84.)

31 FOOTSWITCH jack

This is for connection to Footswitch for control over sustain, just like the damper pedal on a piano. (See page 11.)

32 PHONES/OUTPUT jack

This is for connection to a set of stereo headphones or to an external amplifier/speaker system. (See page 11.)

33 DC IN 12V jack

This is for connection to a PA-5D or PA-5C AC power adaptor. (See page 10.)



Setting Up

This section contains information about setting up your DGX-500/300 for playing. Make sure to read this section carefully before using the instrument.

Power Requirements

Although the DGX-500/300 will run either from an AC adaptor or batteries, Yamaha recommends use of an AC adaptor whenever possible. An AC adaptor is more environmentally friendly than batteries and does not deplete resources.

CAUTION

- Never interrupt the power supply (e.g. remove the batteries or unplug the AC adaptor) during any DGX-500/300 record operation! Doing so can result in a loss of data.

■ Using an AC Power Adaptor

- ① Make sure that the [STANDBY/ON] switch of the DGX-500/300 is set to STANDBY.
- ② Connect the AC adaptor (PA-5D, PA-5C or other adaptor specifically recommended by Yamaha) to the power supply jack.
- ③ Plug the AC adaptor into an AC outlet.

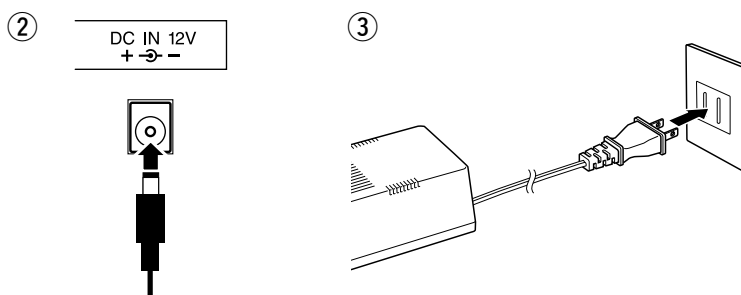

WARNING

- Use ONLY a Yamaha PA-5D, PA-5C AC Power Adaptor (or other adaptor specifically recommended by Yamaha) to power your instrument from the AC mains. The use of other adaptors may result in irreparable damage to both the adaptor and the DGX-500/300.
- Unplug the AC Power Adaptor when not using the DGX-500/300, or during electrical storms.

■ Using Batteries

For battery operation the DGX-500/300 requires six 1.5V “D” size, R20P (LR20) or equivalent batteries. (Alkaline batteries are recommended.) When the batteries need to be replaced, the volume may be reduced, the sound may be distorted, and other problems may occur. When this happens, turn the power off and replace the batteries, as described below

- ① Turn the instrument upside-down on the soft cloth, then open the battery compartment cover located on the instrument’s bottom panel.
- ② Insert the six new batteries as shown in the illustration, making sure that the positive and negative terminals are properly aligned.
- ③ Replace the compartment cover, making sure that it locks firmly in place.

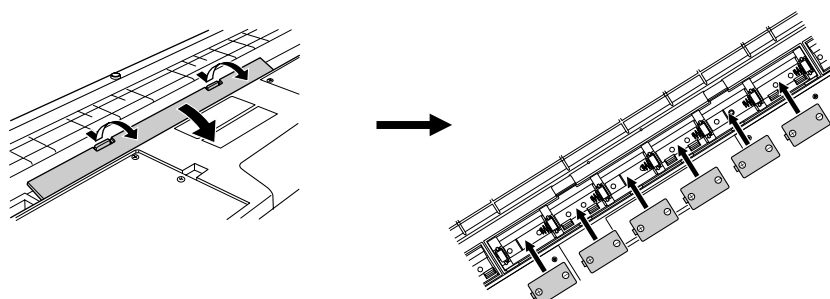

CAUTION

- When the batteries run down, replace them with a complete set of six new batteries. NEVER mix old and new batteries.
- Do not use different kinds of batteries (e.g. alkaline and manganese) at the same time.
- If the instrument is not to be in use for a long time, remove the batteries from it, in order to prevent possible fluid leakage from the battery.
- Do not open the battery compartment cover while the instrument is still on the stand. Make sure to properly turn the instrument face down when opening the battery compartment cover.

Turning On the Power

With the AC power adaptor connected or with batteries installed, simply press the power switch until it locks in the ON position. When the instrument is not in use, be sure to turn the power off. (Press the switch again so that it pops up.)



CAUTION

• Even when the switch is in the “STANDBY” position, electricity is still flowing to the instrument at the minimum level. When you are not using the DGX-500/300 for a long time, make sure you unplug the AC power adaptor from the wall AC outlet, and/or remove the batteries from the instrument.

Accessory Jacks

■ Using Headphones

For private practicing and playing without disturbing others, connect a set of stereo headphones to the rear panel PHONES/OUTPUT jack. Sound from the built-in speaker system is automatically cut off when you insert a headphone plug into this jack.

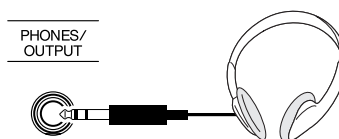

■ Connecting a Keyboard Amplifier or Stereo System

Though the DGX-500/300 is equipped with a built-in speaker system, you can also play it through an external amplifier/speaker system. First, make sure the DGX-500/300 and any external devices are turned off, then connect one end of a stereo audio cable to the LINE IN or AUX IN jack(s) of the other device and the other end to the rear panel PHONES/OUTPUT jack on the DGX-500/300.

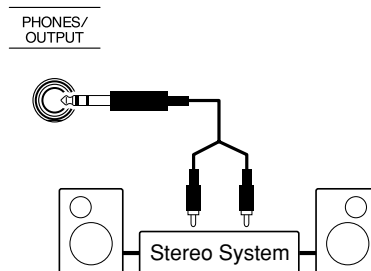

CAUTION

• To prevent damage to the speakers, set the volume of the external devices at the minimum setting before connecting them. Failure to observe these cautions may result in electric shock or equipment damage. Also, be sure to set the volumes of all devices at their minimum levels and gradually raise the volume controls while playing the instrument to set the desired listening level.

■ Using a Footswitch

This feature lets you use a footswitch (Yamaha FC4 or FC5) to sustain the sound of the voices. The footswitch functions the same way as a damper pedal on an acoustic piano — press and hold down the footswitch as you play the keyboard to sustain the sound.

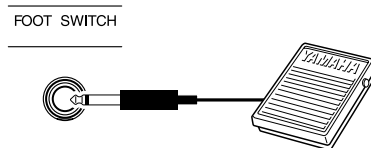

NOTE

• Make sure that the footswitch plug is properly connected to the FOOT SWITCH jack before turning on the power.
• Do not press the footswitch while turning the power on. Doing this changes the recognized polarity of the footswitch, resulting in reversed footswitch operation.

■ Using the MIDI Terminals

The DGX-500/300 also features MIDI terminals, allowing you to interface the DGX-500/300 with other MIDI instruments and devices. (For more information, see page 84.)

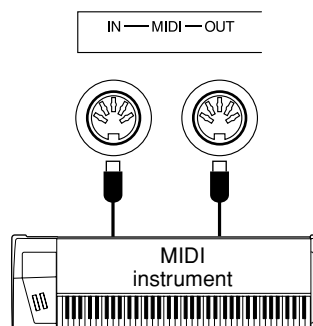

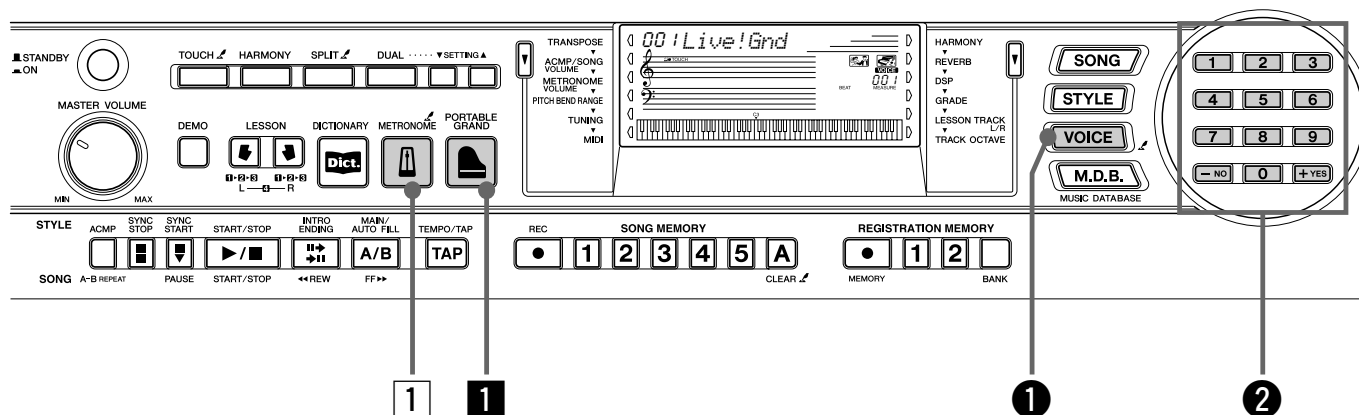

Playing the Piano

Simply by pressing the [PORTABLE GRAND] button, you can automatically reset the entire DGX-500/300 for piano play.

- 1 Press the [PORTABLE GRAND] button.

PORTABLE GRAND



00 | Live! Gnd

- 2 Play the keyboard.

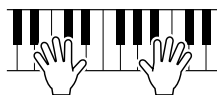

Want to find out more? See page 22.

Playing along with the Metronome

- 1 Press the [METRONOME] button.

METRONOME



Want to find out more? See page 22.

Selecting and Playing Other Voices

The DGX-500/300 has a huge total of 619 dynamic and realistic instrument voices. Let's try a few of them out now...

1 Press the [VOICE] button.



00 | Live! Gnd



2 Select a voice.

1 2 3

4 5 6

7 8 9

- NO 0 + YES

002 GrandPno

3 Play the keyboard.

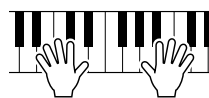

Want to find out more? See page 24.

Panel Voice List

No.	Voice Name
PIANO	
001	Live! Grand
002	Grand Piano
003	Bright Piano
004	Honky-tonk Piano
005	MIDI Grand Piano
006	CP 80
007	Harpischord
E.PIANO	
008	Galaxy EP
009	Funky Electric Piano
010	DX Modern Elec. Piano
011	Hyper Tines
012	Venus Electric Piano
013	Clavi
ORGAN	
014	Cool! Organ
015	Jazz Organ 1
016	Jazz Organ 2
017	Click Organ
018	Bright Organ
019	Rock Organ
020	Purple Organ
021	16'+2' Organ
022	16'+4' Organ
023	Theater Organ
024	Church Organ
025	Chapel Organ
026	Reed Organ
ACCORDION	
027	Traditional Accordion
028	Musette Accordion
029	Bandoneon
030	Harmonica
GUITAR	
031	Classical Guitar
032	Folk Guitar
033	12Strings Guitar
034	Jazz Guitar

No.	Voice Name
035	Octave Guitar
036	Clean Guitar
037	60's Clean Guitar
038	Muted Guitar
039	Overdriven Guitar
040	Distortion Guitar
BASS	
041	Acoustic Bass
042	Finger Bass
043	Pick Bass
044	Fretless Bass
045	Slap Bass
046	Synth Bass
047	Hi-Q Bass
048	Dance Bass
STRINGS	
049	String Ensemble
050	Chamber Strings
051	Synth Strings
052	Slow Strings
053	Tremolo Strings
054	Pizzicato Strings
055	Orchestra Hit
056	Violin
057	Cello
058	Contrabass
059	Banjo
060	Harp
CHOIR	
061	Choir
062	Vocal Ensemble
063	Vox Humana
064	Air Choir
SAXOPHONE	
065	Soprano Sax
066	Alto Sax
067	Sweet Tenor
068	Breathy Tenor
069	Tenor Sax

No.	Voice Name
070	Baritone Sax
071	Oboe
072	English Horn
073	Bassoon
074	Clarinet
TRUMPET	
075	Trumpet
076	Muted Trumpet
077	Trombone
078	Trombone Section
079	French Horn
080	Tuba
BRASS	
081	Brass Section
082	Big Band Brass
083	Mellow Horns
084	Synth Brass
085	Jump Brass
086	Techno Brass
FLUTE	
087	Sweet Flute
088	Flute
089	Piccolo
090	Pan Flute
091	Recorder
092	Ocarina
SYNTH LEAD	
093	Square Lead
094	Sawtooth Lead
095	Voice Lead
096	Star Dust
097	Brightness
098	Analogon
099	Fargo
SYNTH PAD	
100	Fantasia
101	Bell Pad
102	Xenon Pad
103	Equinox

No.	Voice Name
104	Dark Moon
PERCUSSION	
105	Vibraphone
106	Marimba
107	Xylophone
108	Steel Drums
109	Celesta
110	Tubular Bells
111	Timpani
112	Music Box
SPLIT	
113	Acoustic Bass/Live! Grand
114	Finger Bass /Grand Piano
115	Fretless Bass/DX Modern Elec. Piano
116	Acoustic Bass/Vibraphone
117	Fretless Bass/Brass Section
118	Analogon/Sawtooth Lead
119	Slap Bass/Clavi
120	Classical Guitar/Sweet Flute
121	String Ensemble/Live! Grand
122	Vox Humana/Choir
DRUM KITS	
123	Standard Kit 1
124	Standard Kit 2
125	Room Kit
126	Rock Kit
127	Electronic Kit
128	Analog Kit
129	Dance Kit
130	Jazz Kit
131	Brush Kit
132	Symphony Kit
133	SFX Kit 1
134	SFX Kit 2

* This list includes only a portion of the total available voices.

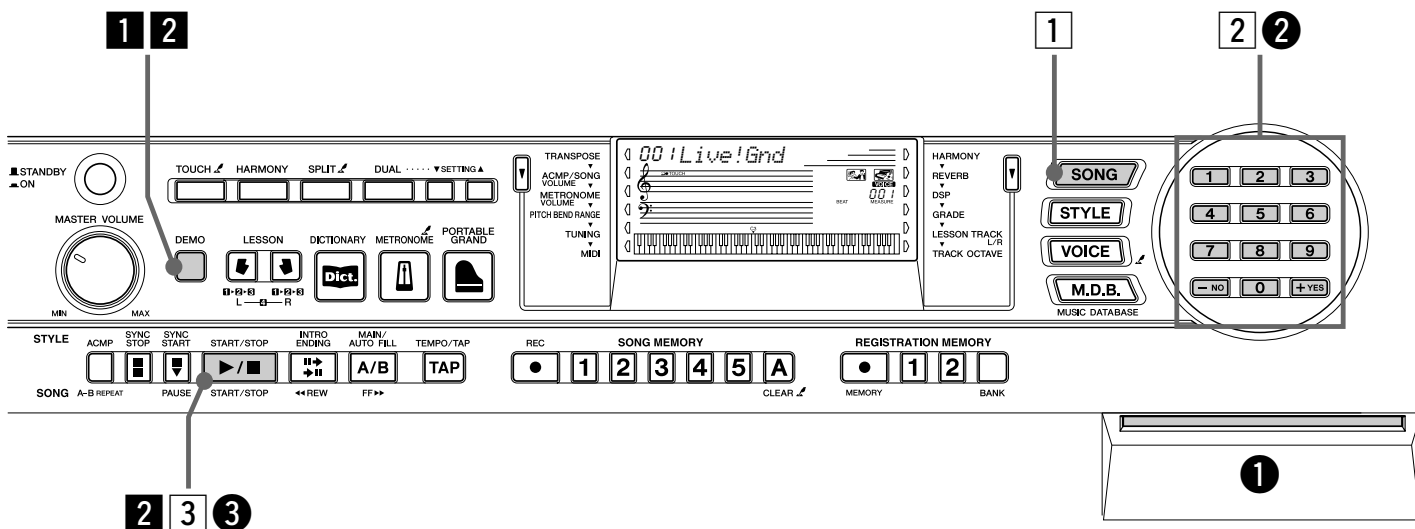

Playing the Songs

The DGX-500/300 is packed with a total of 100 songs, including three Demo songs that have been specially created to showcase the rich and dynamic sounds of the instrument. You can also try out the songs with the educational Lesson feature.

Playing the Demo songs

Let's play the Demo songs now, Repeating with (001 - 003)

1 Start the Demo song.



You can also play back songs of other categories. Simply select the appropriate number of the desired song during playback.

2 Stop the Demo song.

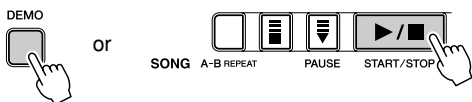

NOTE

- The DGX-500/300 also has a Demo Cancel function that allows you to disable Demo playback. To enable Demo Cancel, simultaneously hold down the [DEMO] button and turn on the power. To restore the Demo capabilities, simply turn the power off and on again.

Playing a single song

Naturally, you can also individually select and play back the DGX-500/300's songs (001 - 205).

1 Press the [SONG] button.

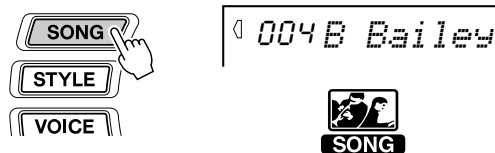

2 Select a song.

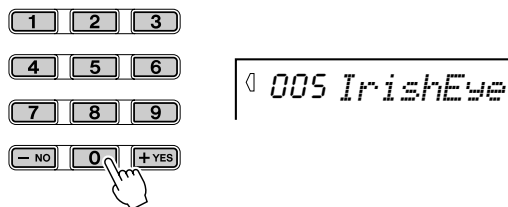

3 Start (and stop) the song.

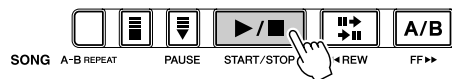

Want to find out more? See page 57.

Playing the Disk Song

This function lets you play songs contained on the included disk or on other song data disks.

1 Insert the disk.

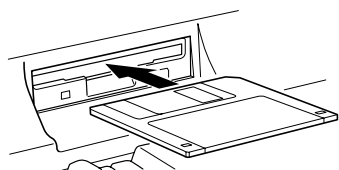

2 Select a desired User song.

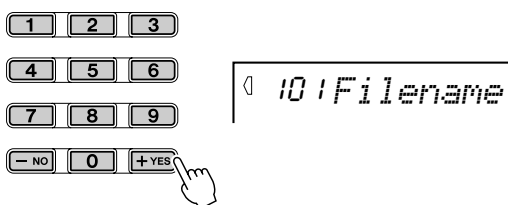

3 To start or stop playing, press the [START/STOP] button.

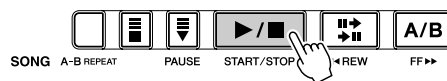

Want to find out more? See page 75.

● Song List

No.	Song Name
DEMO	
001	The Look Of Love (DGX-500)
	Ribbon In The Sky (DGX-300)
002	Just The Way You Are
003	Ribbon In The Sky (DGX-500)
	The Look Of Love (DGX-300)
FAVORITES	
004	Bill Bailey (Won't You Please Come Home)
005	When Irish Eyes Are Smiling
060	Down By The Riverside
007	America The Beautiful
008	When The Saints Go Marchin' In
ORCHESTRA	
009	Frühlingsstimmen
010	Danse Des Mirlitons From "The Nutcracker"
011	"Orphée Aux Enfers" Overture
012	Slavonic Dances No.10
013	La Primavera (From Le Quattro Stagioni)
014	Méditation De Thais
015	Guillaume Tell
016	Camptown Races
017	Frühlingslied
018	Ungarische Tänze Nr.5
PIANIST	
019	Dolly's Dreaming And Awakening
020	La Candeur
021	Arabesque

No.	Song Name
022	Pastorale
023	Petite Réunion
024	Innocence
025	Progrès
026	Tarentelle
027	La Chevaleresque
028	Etude Op.10-3 "Chanson De L'adieu"
029	Marcia Alla Turca
030	Turkish March
031	Valse Op.64-1 "Peiti Chien"
032	Menuett
033	Nocturne Op.9-2
034	Moments Musicaux Op.94-3
035	The Entertainer
036	Prelude (Wohltemperierte Klavier 1-1)
037	La Violette
038	Für Elise
PRACTICE	
039	Little Brown Jug
040	Loch Lomond
041	Oh! Susanna
042	Greensleeves
043	Aura Lee
044	Londonderry Air
045	Ring De Banjo
046	Wenn Ich Ein Vöglein Wär ?
047	Die Lorelei
048	Funiculi-Funicula
049	Turkey In The Straw
050	Old Folks At Home
051	Silent Night
052	Jingle Bells
053	Muss I Denn

No.	Song Name
054	Liebesträume Nr.3
055	Jesu, Joy Of Man's Desiring
056	Symphonie Nr.9
057	Song Of The Pearl Fisher
058	Gavotte
059	String Quartet No.17 2nd Mov. "Serenade"
060	Menuett
061	Canon
062	The Danube Waves
063	From "The Magic Flute"
064	Piano Sonate Op.27-2 "Mondschein"
065	"The Surprise" Symphony
066	To A Wild Rose
067	Air de Toréador "Carmen"
068	O Mio Babbino Caro (From "Gianni Schicchi")
DUET	
069	Row Row Row Your Boat
070	On Top Of Old Smoky
071	We Wish You A Merry Christmas
072	Scarborough Fair
073	Im Mai
074	O Christmas Tree
075	Mary Had A Little Lamb
076	Ten Little Indians
077	Pop Goes The Weasel
078	Twinkle Twinkle Little Star
079	Close Your Hands, Open Your Hands
080	The Cuckoo
081	O Du Lieber Augustin
082	London Bridge

No.	Song Name
CHORD LESSON	
083	Twinkle Twinkle Little Star
084	The Cuckoo
085	London Bridge
086	American Patrol
087	Beautiful Dreamer
088	Battle Hymn Of The Republic
089	Home Sweet Home
090	Valse Des Fleurs (From "The Nutcracker")
091	Aloha Oe
092	I've Been Working On The Railroad
093	My Darling Clementine
094	Auld Lang Syne
095	Grandfather's Clock
096	Amazing Grace
097	My Bonnie
098	Yankee Doodle
099	Joy To The World
100	Ave Maria

* For the songs #004 - #100, refer to the included Song Book.

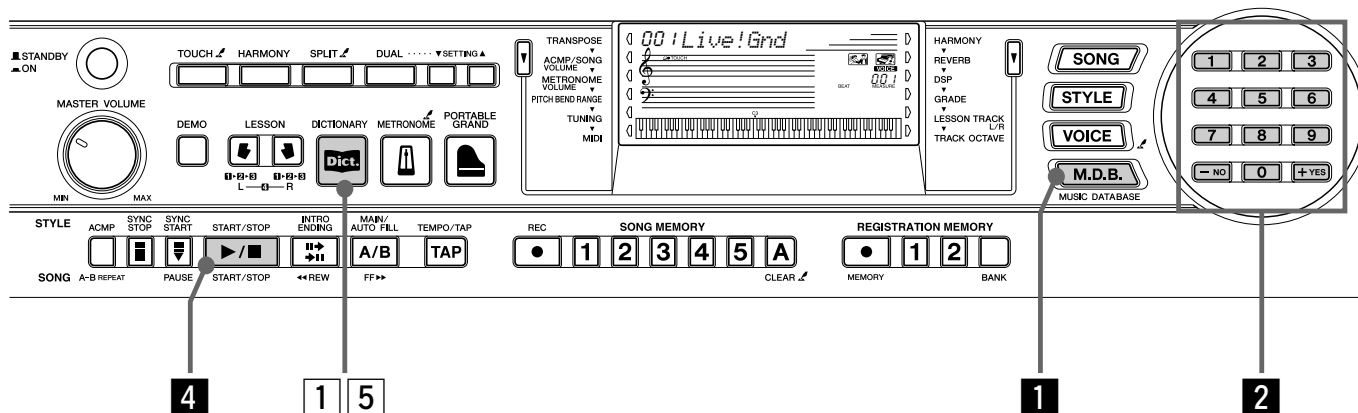

Music Database

Here's a convenient feature that lets you instantly reconfigure the DGX-500/300 for playing in different music styles. If you want to perform in a certain genre but don't know what settings to make, simply select the genre from the Music Database — and the DGX-500/300 makes all the right settings for you!

NOTE

- For more information on playing proper chords for the auto accompaniment, see "Using Auto Accompaniment — Multi Fingering" on page 47 and "Looking up Chords in the Dictionary" on the next page.

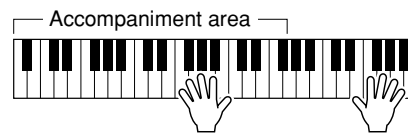

Left hand + Right hand

Auto accompaniment (for example, bass + guitar + drums) + **Melody**

1 Press the [M.D.B.] (MUSIC DATABASE) button.

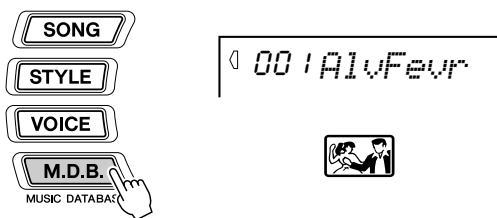

2 Select a Music Database.

Refer to the Music Database List on page 99.

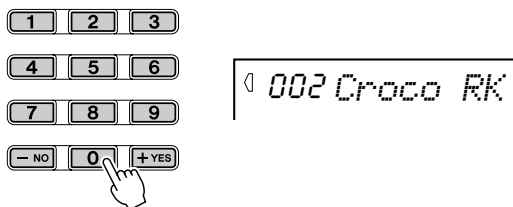

3 Play a chord with your left hand.

The style starts as soon as you play the keyboard. For more on chords, see "Looking up Chords in the Dictionary" on the next page.

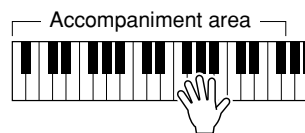

4 Stop the style.

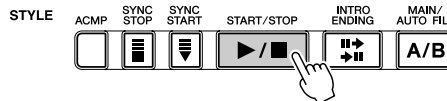

Want to find out more? See page 53.

Looking up Chords in the Dictionary

The convenient Dictionary function teaches you how to play chords by showing you the individual notes. In the example below, we'll learn how to play a GM7 chord...

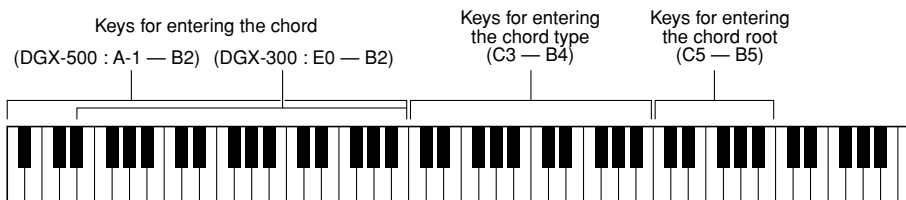

Learning how to play a specific chord

Example: **G M7**
 Root note Chord type

- 1 Press the [DICTIONARY] button.

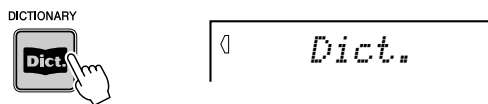

- 2 Specify the root note of the chord (in this case, G).

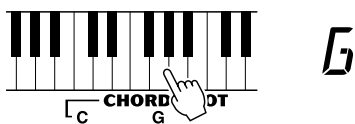

- 3 Specify the chord type of the chord (in this case, M7).

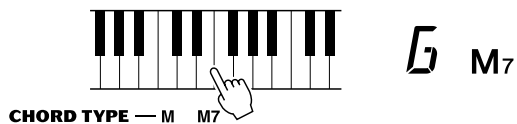

- 4 Play the notes of the chord as indicated in the keyboard diagram in the display. The chord name flashes when the chord is played properly.

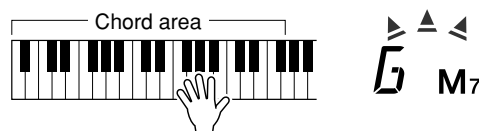
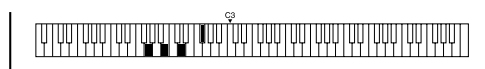

- 5 To leave the Dictionary function, press the [DICTIONARY] button again



Want to find out more? See page 50.

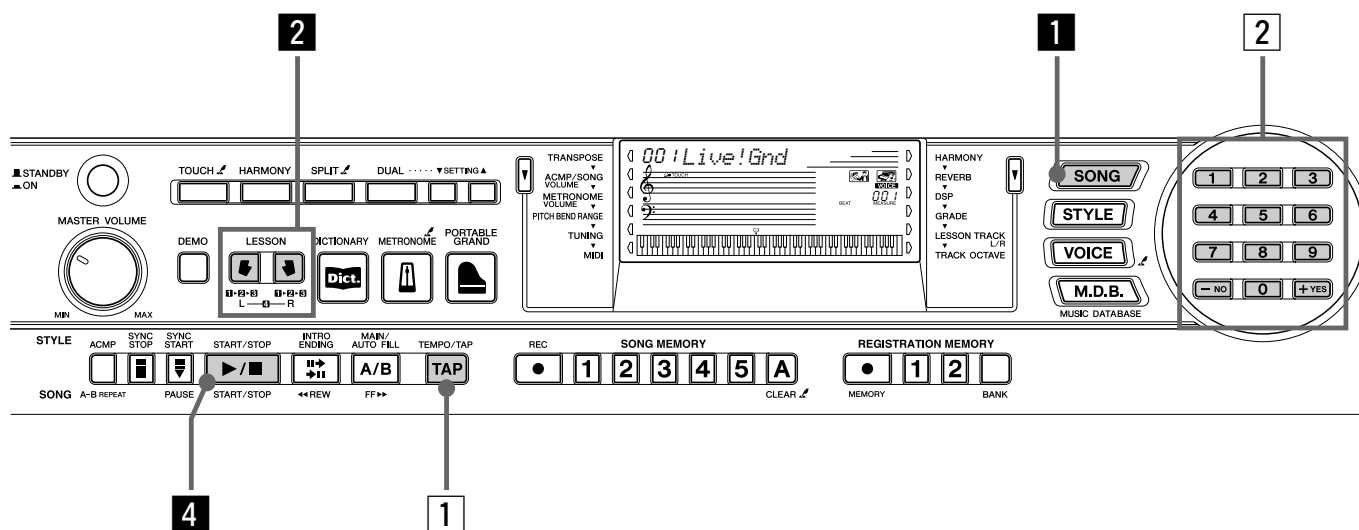

Using the Lesson Feature

Songs 001 to 100 are specially designed for use with the educational Lesson feature. Lesson makes it fun and easy to master these songs. You can practice the left- and right-hand parts of each song individually: simply press the appropriate button, [L] (left) or [R] (right). The practice steps below apply to either hand.

- Lesson 1 — Timing** This lesson step lets you practice just the timing of the notes.
- Lesson 2 — Waiting** In this lesson step, the DGX-500/300 waits for you to play the correct notes before continuing playback of the song.
- Lesson 3 — Minus One** This lesson step plays back the song with one part muted — letting you play and master the missing part yourself.
- Lesson 4 — Both Hands** This lesson step is the same as “Minus One,” except in that both the left- and right-hand parts are muted — letting you play and master both hands.

1 Select one of the Lesson songs.
For instructions on selecting songs, see page 67.



2 Select the part you wish to work on (left or right) and the Lesson step.
If you want to work on the right-hand part, press the [R] button; to work on the left, press the [L] button.

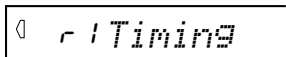
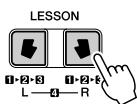

NOTE

- Each press of the corresponding button ([L] or [R]) alternately selects Lessons 1 - 3. Pressing both buttons simultaneously calls up Lesson 4, Both Hands.

3 Start the Lesson.

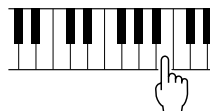

4 When you're finished, stop the Lesson.



NOTE

- You can also exit from the Lesson by pressing one the LESSON buttons ([L] or [R]) repeatedly until song name is shown in the display.

Lesson 1 — Timing

This step lets you work on the timing of the notes. In Lesson 1, the particular note you play on the keyboard is unimportant. The DGX-500/300 checks your timing and how rhythmically “tight” your playing is.

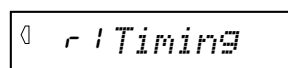
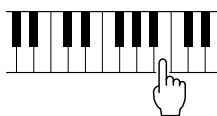

Want to find out more? See page 69.

Lesson 2 — Waiting

In Lesson 2, you practice playing the notes correctly as they appear in the display notation. The accompaniment pauses and waits for you to play the notes correctly before it continues.

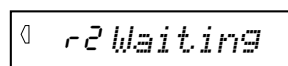
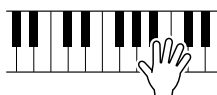

Want to find out more? See page 70.

Lesson 3 — Minus One

In Lesson 3, one of the parts is muted, and you practice the missing part in time with the rhythm.

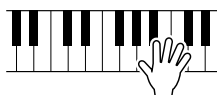

Want to find out more? See page 70.

Lesson 4 — Both Hands

Lesson 4 is just like Lesson 3, except that the parts for both hands are muted, letting you practice the missing parts in time with the rhythm.



Want to find out more? See page 71.

Grade

The DGX-500/300 has a built-in evaluation function that monitors your practicing and — like a real teacher — tells you how well you did each exercise. Four grades are assigned, depending on your performance: “OK,” “Good,” “Very Good!,” and “Excellent!”

Want to find out more? See page 72.

Changing the Tempo

Naturally, you can change the tempo (speed) of the song to your liking, letting you slow down difficult passages and bring up the tempo gradually until you master them at normal speed.

- 1 Press the [TEMPO/TAP] button.



- 2 Use the numeric keypad to set the desired tempo.

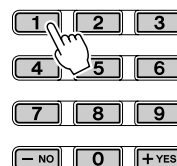

NOTE

• The DGX-500/300 also has a convenient Tap Tempo function that allows you to “tap” a new tempo in real time. (See page 40.)



Panel Display Indications

The DGX-500/300 features a large multi-function display that shows all important settings for the instrument. The section below briefly explains the various icons and indications in the display.

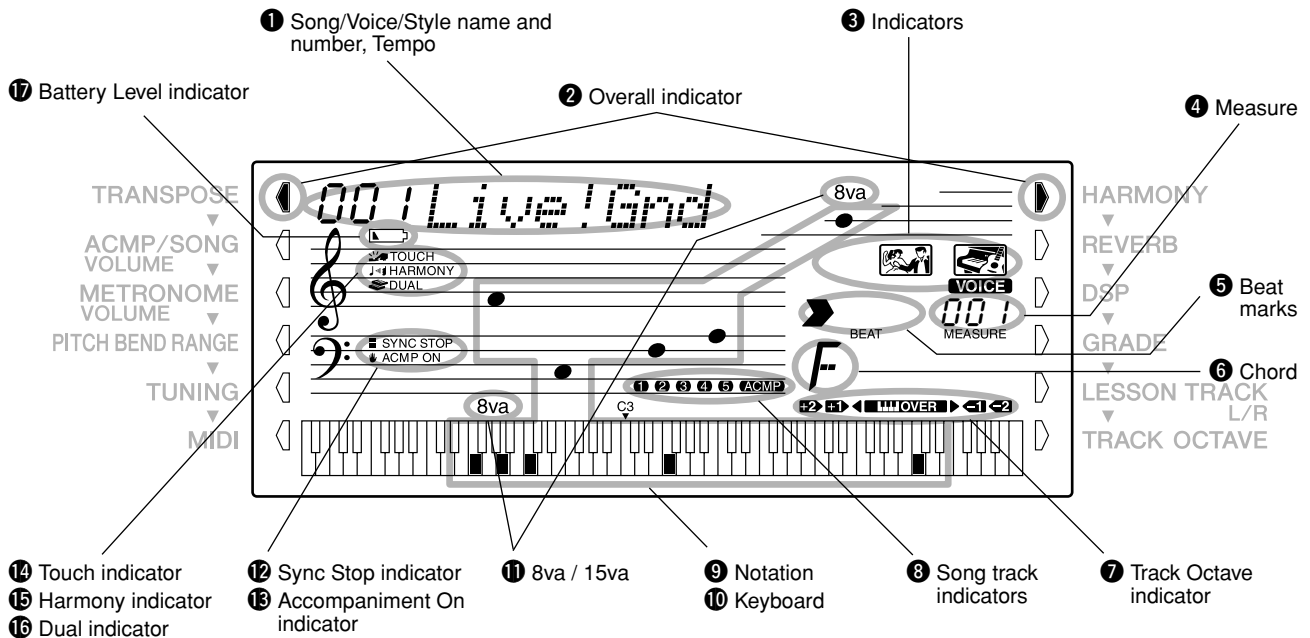

1 Song/Voice/Style name and number, Tempo

This portion of the display indicates the name and number of the currently selected song, voice, or style. It also displays the name and current value or setting of the Overall functions and the Function parameters, as well as other important operation messages. When the tempo setting is active, the value is shown.

2 Overall indicator

The Overall buttons (on either side of the LCD) let you access the Function operations and settings of the DGX-500/300. The currently selected setting is indicated by a dark bar that appears next to its name (printed on the panel).

3 Indicators

These indicate the operating condition of the DGX-500/300 as shown below:

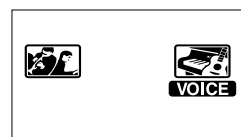

Using the numeric keypad selects **voice** numbers. Pressing the [START/STOP] button starts **song** playback.



Using the numeric keypad selects **voice** numbers. Pressing the [START/STOP] button starts **style** playback.



Using the numeric keypad selects **song** numbers. Pressing the [START/STOP] button starts **song** playback.



Using the numeric keypad selects **style** numbers. Pressing the [START/STOP] button starts **style** playback.

④ Measure

These show the current measure during playback of a song or style.

⑤ Beat marks

These marks (one large, three small) flash in sequence and in time with the song or style. The large arrow indicates the first beat of the measure.

⑥ Chord

When a song (with chords) is being played back, this indicates the current chord root and type. It also indicates chords played in the accompaniment area of the keyboard when the Style mode and auto accompaniment are on.

⑦ Track Octave indicator

When a disk song is playing and the note data exceeds the range limit of A-1 – C7 (DGX-500) and E0 – G6 (DGX-300), an “OVER” indication flashes and ◀ or ▶ appears in the display.

When a disk song is playing and the track octave setting is raised or lowered, one of +2, +1, -1 and -2 indications appears in the display.

⑧ Song track indicators

In the song recording and playback, these indicate the status of the tracks. (See page 63.)

⑨ Notation / ⑩ Keyboard

These two portions of the display conveniently indicate notes. When a song is being played back, they show the melody or chord notes in succession. When you play the keyboard yourself, the display shows the notes you play.

NOTE

- For a few specific chords, not all notes may be shown in the notation section of the display. This is due to space limitations in the display.

⑪ 8va / 15va

Notes played outside the displayable area are indicated by octave marks (“8va” or “15va”).

⑫ Sync Stop indicator

This appears when the Sync Stop function is turned on. (See page 43.)

⑬ Accompaniment On indicator

This appears when the auto accompaniment has been turned on. (See page 39.)

⑭ Touch indicator

This appears when the Touch function is turned on. (See page 32.)

⑮ Harmony indicator

This appears when the Harmony effect is turned on. (See page 35.)

⑯ Dual indicator

This appears when the Dual function is turned on. (See page 26.)

⑰ Battery Level indicator

This appears when the battery power is too low to ensure proper operation. (See page 10.)

Music Rest

Insert the bottom edge of the included music rest into the slot located at the top rear of the DGX-500/300 control panel.

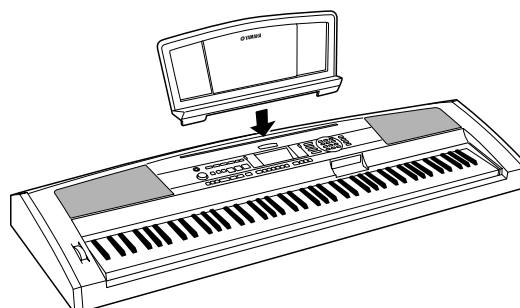



Portable Grand

This convenient function lets you instantly call up the Grand Piano voice.

Playing the Portable Grand

Press the [PORTABLE GRAND] button.



Doing this automatically calls up the special “Stereo Sampled Piano” Live! Grand voice.

Using the Metronome

1 Call up the Tempo setting.

Press the [TEMPO/TAP] button.

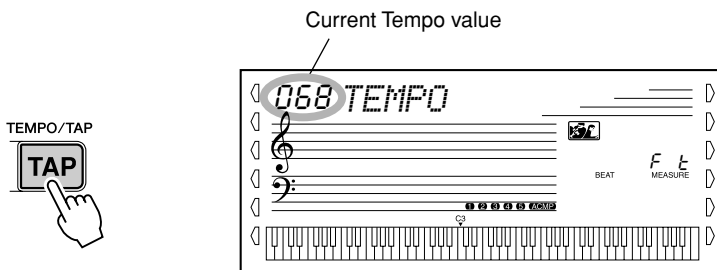

2 Change the value.

Use the numeric keypad to set the desired Tempo value, or use the [+]/[-] buttons to increase or decrease the value.

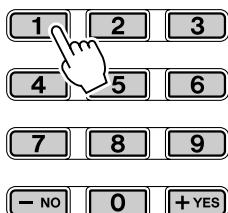

3 Turn on the Metronome.

Press the [METRONOME] button.

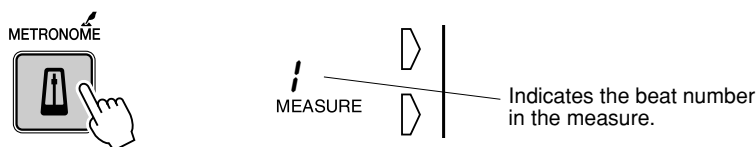

To turn the Metronome off, press the [METRONOME] button again.

Setting the Metronome Time Signature

The time signature of the Metronome can be set to various quarter-note based meters.



- The time signature changes automatically when a style or song is selected.

Numeric keypad	Time signature
01	1/4 — Plays only “1” beats (all high clicks)
02	2/4
03	3/4
04	4/4
:	:
15	15/4
0	Plays no “1” beats (all low clicks)

Hold down the [METRONOME] button (until “TIME SIG” appears in the display), then press the button on the numeric keypad that corresponds to the desired time signature (see chart at right).

Indicates current beat number



Adjusting the Metronome Volume

You can adjust the volume of the Metronome sound independently of the other DGX-500/300 sounds. The volume range is 000 - 127.

1 Call up the Metronome Volume setting.

Press the left Overall button until “MTR VOL” appears in the display.

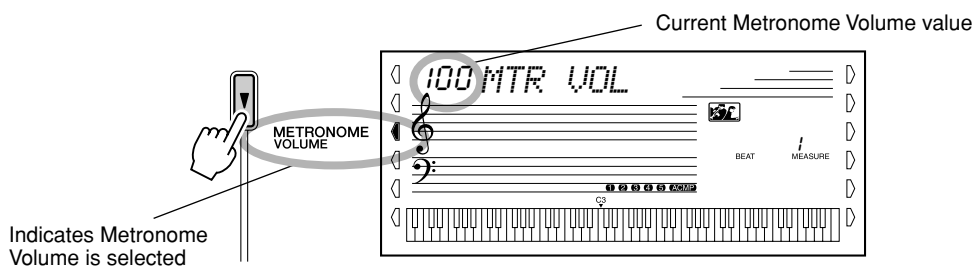

Indicates Metronome Volume is selected

2 Change the value.

Use the numeric keypad to set the desired Metronome Volume value, or use the [+]/[-] buttons to increase or decrease the value.

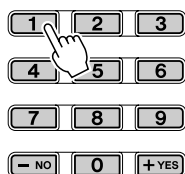

Restoring the Default Metronome Volume Value

To restore the default Metronome Volume value (100), press both [+]/[-] buttons simultaneously (when Metronome Volume is selected in the Overall menu).



Playing Voices

The DGX-500/300 features a total of 619 authentic voices — all of which have been created with Yamaha’s sophisticated AWM (Advanced Wave Memory) tone generation system. These include 480 XG voices, plus special Split voices, DJ voices and drum kits. The DGX-500/300 also has a Dual Voice function that lets you combine two different voices in a layer, and play the two together across the keyboard.

The voices are divided into various instrument categories, and the names are printed on the panel for convenience. For a complete list of available voices, see page 91.

Special **Split voices** (#113 - #122) feature two different voices that you can play from separate area of the keyboard — for example, playing a bass voice with your left hand and a piano voice with your right hand.

A special set of **DJ voices** (#615 - #619) provides dynamic, exciting voices for playing many of today’s popular music styles. (See page 97.)

The Voice mode also features special effect sections that let you enhance the sound of the voice. These include Reverb and Harmony, as well as a “DSP” section that provides miscellaneous effects, such as tremolo, echo, delay, equalization, and wah. (See page 34.)

There’s also a Touch Sensitivity control (page 32), which determines how the voices respond to your playing technique.

The DGX-500/300 also includes special **Drum Kit voices** — #123 - #134 — that let you play various drum and percussion sounds from the keyboard. (Refer to the Drum Kit Voice list on page 100.)

When a voice is selected, the most suitable DSP Type (page 36) and Harmony Type (page 37) for the voice are automatically called up.

Playing a Voice

1 Press the [VOICE] button.

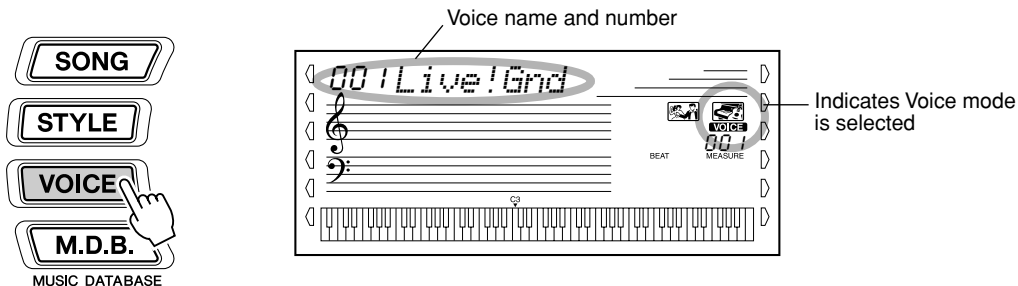

2 Select the desired voice number.

Use the numeric keypad. The voice categories and their numbers are shown on the panel. A complete list of the available voices is given on page 91.

VOICE

001~007 PIANO	049~060 STRINGS	100~104 SYNTH PAD
008~013 E. PIANO	061~064 CHOIR	105~112 PERCUSSION
014~026 ORGAN	065~074 SAXOPHONE	113~122 SPLIT
027~030 ACCORDION	075~080 TRUMPET	123~134 DRUM KITS
031~040 GUITAR	081~086 BRASS	135~614 XG
041~048 BASS	087~092 FLUTE	615~619 DJ
	093~099 SYNTH LEAD	000 OTS

There are two ways to select voices: 1) directly entering the voice number with the numeric keypad, or 2) using the [+]/[-] buttons to step up and down through the voice numbers.

■ Using the numeric keypad

Enter the digits of the voice number as indicated on the panel. For example, to select voice #109, press “1” on the numeric keypad, then “0”, “9.” For voice numbers beginning with zeroes (such as #042 or #006), the initial zeroes may be omitted. In this case, there is a short pause before the indication appears.

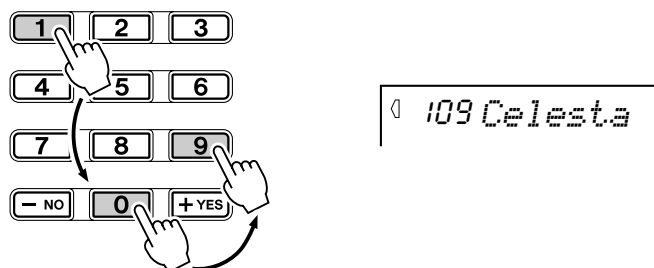

■ Using the [+]/[-] buttons

Press the [+] button to select the next voice number, and press the [-] button to select the previous voice. Holding down either button continuously scrolls up or down through the numbers.

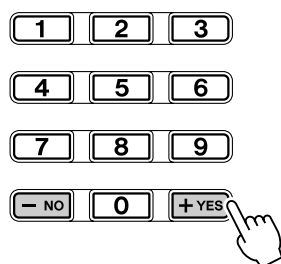

NOTE

- Each voice is automatically called up with the most suitable octave range setting. Thus, playing middle C with one voice may sound higher or lower than another voice at the same key.

3 Play the selected voice.

Since either the Style or Song mode is active in the background (as indicated by the illustration in the display), you can also play styles or songs, respectively, in the Voice mode by simply pressing the [START/STOP] button. The last selected style or song will be played.

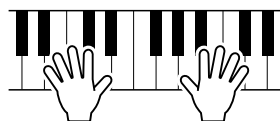

Playing Voices

Drum Kit Voice Chart (voices 123 - 134)

When one of the 12 Drum Kit voices are selected you can play different drums and percussion instruments on the keyboard.

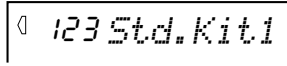

No.	Name	LCD
123	Standard Kit 1	Std.Kit1
124	Standard Kit 2	Std.Kit2
125	Room Kit	Room Kit
126	Rock Kit	Rock Kit
127	Electronic Kit	Elct.Kit
128	Analog Kit	AnlogKit
129	Dance Kit	DanceKit
130	Jazz Kit	Jazz Kit
131	Brush Kit	BrushKit
132	Symphony Kit	SymphKit
133	SFX Kit 1	SFX Kit1
134	SFX Kit 2	SFX Kit2

● For example, when 123 “Standard Kit 1” is selected:

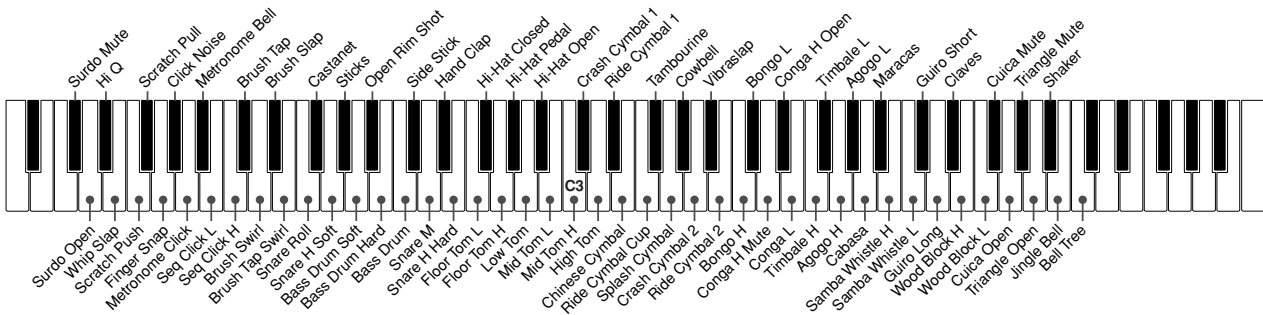

Dual Voice

The Dual Voice function lets you combine two different voices in a layer — one the Main voice, which is selected normally, and the other the Dual voice, which is selected here. You can also set various parameters independently for these voices, such as giving them separate volume, octave, Reverb and DSP settings. This lets you create an optimum mix for the voices, and enhance the way they blend together.

1 Turn the Dual voice on or off.

Press the [DUAL] button.

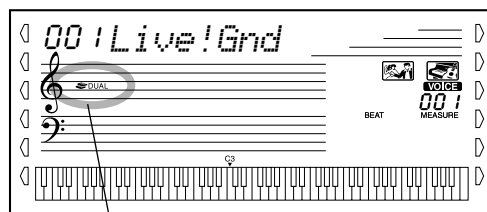
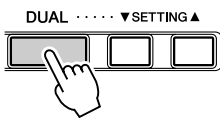

Indicates Dual is turned on

2 Select one of the parameters for the Main and Dual voices.

Press the [SETTING ▲] or [SETTING ▼] button, repeatedly if necessary, until the desired parameter's name appears in the display.

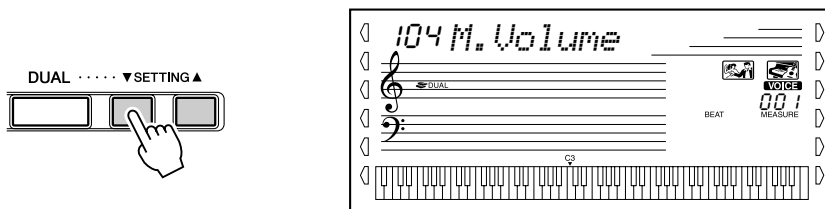

3 Set the parameter's value.

Use the numeric keypad or the [+]/[-] buttons. (Refer to the parameter list below.)

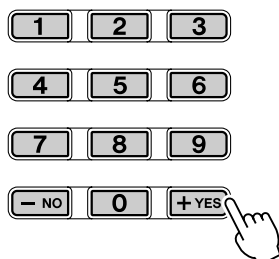

NOTE

• The Dual Voice function is not available in the Lesson.

Main Voice and Dual Voice settings

The parameters below provide all settings for both the Main Voice and Dual Voice — letting you change or enhance the sound of these voices independently.

- Main Volume
- Dual DSP Level
- Main DSP Level
- Dual Reverb Level
- Main Reverb Level
- Dual Octave
- Dual Voice
- Dual Volume

Parameters

Parameter Name	Display Name	Range / Settings	
Main Voice Volume	M. Volume	0 – 127	This determines the volume of the Main voice, letting you create an optimum mix with the Dual voice.
Dual Voice DSP	D. DspLv1	0 – 127	This determines how much of the Dual voice's signal is sent to the DSP effect. Higher values result in a louder DSP effect for the Dual voice.
Main Voice DSP	M. DspLv1	0 – 127	This determines how much of the Main voice's signal is sent to the DSP effect. Higher values result in a louder DSP effect for the Main voice.
Dual Voice Reverb	D. RevLv1	0 – 127	This determines how much of the Dual voice's signal is sent to the Reverb effect. Higher values result in a louder Reverb effect for the Dual voice.
Main Voice Reverb	M. RevLv1	0 – 127	This determines how much of the Main voice's signal is sent to the Reverb effect. Higher values result in a louder Reverb effect for the Main voice.
Dual Voice Octave	D. Octave	-2 – 2 (Octaves)	This determines the octave of the Dual voice.
Dual Voice Select	D. Voice name	1 – 619	This selects the Dual voice.
Dual Voice Volume	D. Volume	0 – 127	This determines the volume of the Dual voice, letting you create an optimum mix with the Main voice.

Split Voice

Split Voices let you play two different instrument sounds from separate areas of the keyboard. For example, you can play a bass voice with your left hand and a piano voice with your right.

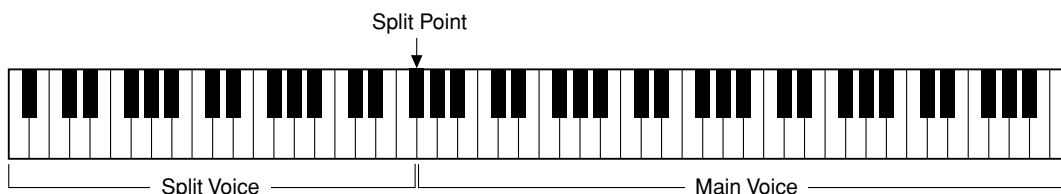

1 Call up a Split Voice.

Press the [SPLIT] button.

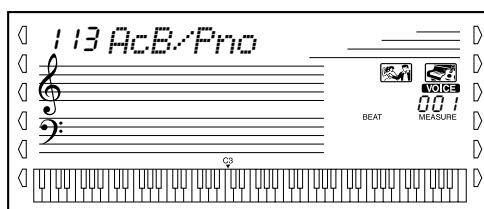

NOTE

- The Split Point setting for the voice is the same as that of the Accompaniment Split Point. (See page 49.)

This instantly calls up the last selected Split Voice.

One Touch Setting

This special “voice” is actually a convenient feature which automatically selects a suitable voice for you when you select a style. The voice is selected to best match the style or song you’ve called up.

1 Select voice #000 (One Touch Setting).

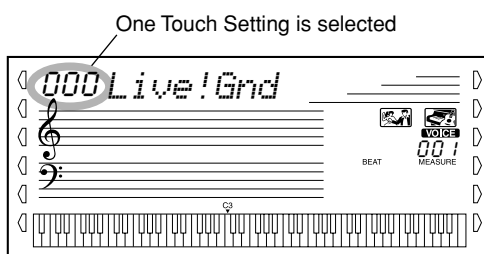
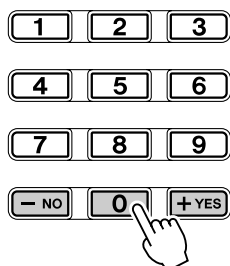

You can also turn on One Touch Setting by simultaneously pressing both the [+]/[-] buttons.

Transpose and Tuning

You can also adjust the tuning and change the transposition (key) of the entire DGX-500/300 sound with the Transpose and Tuning functions.

■ Transpose

Transpose determines the key of both the main voice and the bass/chord accompaniment of the selected style. It also determines the pitch of the songs. This allows you to easily match the pitch of the DGX-500/300 to other instruments or singers, or play in a different key without changing your fingering. The Transpose settings can be adjusted over a range of ± 12 semitones (± 1 octave).

NOTE

• The Transpose function has no effect on the DJ voices (#615 - #619) or the Drum Kits voices (#123 - #134).

1 Select the Transpose function.

Press the left Overall button, repeatedly if necessary, until “TRANSPOS” appears in the display.

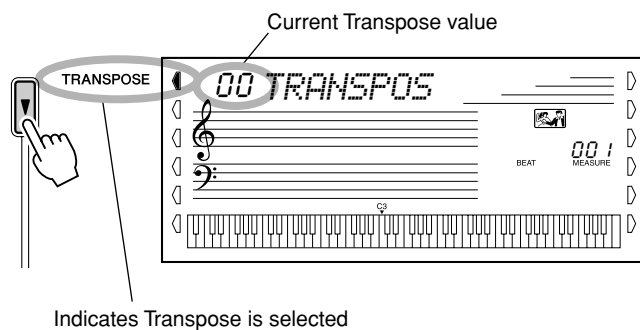

2 Change the value.

Use the numeric keypad to set the desired Transpose value (-12 – +12). To transpose the pitch down, simultaneously press and hold the [-] button, and use the numeric keypad to type in the (negative) value. You can also use the [+]/[-] buttons to increase or decrease the value. Holding down either button continuously increases or decreases the value.

Restoring the Default Transpose Value

If you've changed the Transpose setting, you can instantly restore the default setting of "00" by pressing both [+]/[-] buttons simultaneously (when Transpose is selected).

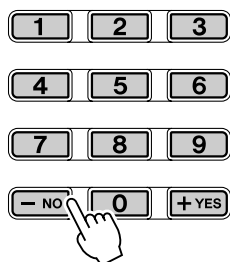

Playing Voices

■ Tuning

Tuning determines the fine pitch setting of both the main voice and the bass/chord accompaniment of the selected style. It also determines the pitch of the songs. This allows you to accurately match the tuning with that of other instruments. The Tuning settings can be adjusted over a range of ± 100 (approx. ± 1 semitone).

1 Select the Tuning function.

Press the left Overall button, repeatedly if necessary, until “TUNING” appears in the display.

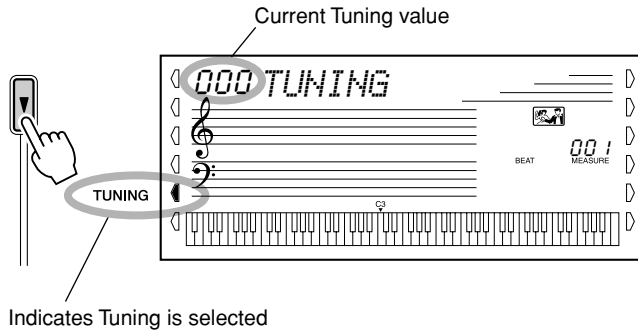

NOTE

- The Tuning settings have no effect on the Drum Kit voices (#123 - #134).

2 Change the value.

Use the numeric keypad to set the desired Tuning value (-100 – +100). To tune the pitch down, simultaneously press and hold the [-] button, and use the numeric keypad to type in the (negative) value. You can also use the [+] / [-] buttons to increase or decrease the value. Holding down either button continuously increases or decreases the value.

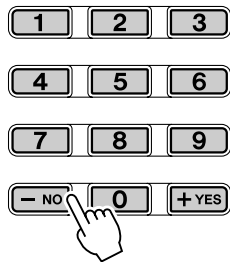

Restoring the Default Tuning Value

If you've changed the Tuning setting, you can instantly restore the default setting of "00" by pressing both [+] / [-] buttons simultaneously (when Tuning is selected).

Pitch Bend Range

The DGX-500/300 has a [PITCH BEND] wheel that lets you change the pitch of the voices in real time, as you play. The Pitch Bend Range parameter determines the amount that pitch is raised or lowered when using the [PITCH BEND] wheel.

At the minimum setting, moving the [PITCH BEND] wheel up or down changes the pitch by a maximum of 1 semitone or half-step in either direction. At the maximum setting of 12, pitch is changed over a range of \pm one octave (12 semitones). The [PITCH BEND] wheel affects the voices played in the right-hand section of the keyboard. (It has no effect on the auto accompaniment.)

1 Select the Pitch Bend Range parameter.

Press the left Overall button, repeatedly if necessary, until “PB RANGE” appears in the display.

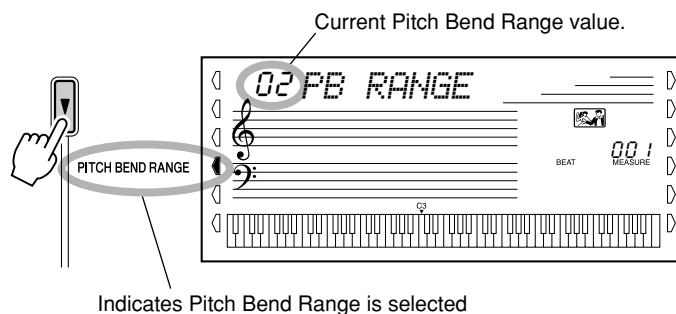

2 Set the Pitch Bend Range value.

Use the numeric keypad or [+] / [-] buttons to set the desired range: 1 - 12 (semitones).

3 Play the keyboard and move the [PITCH BEND] wheel.

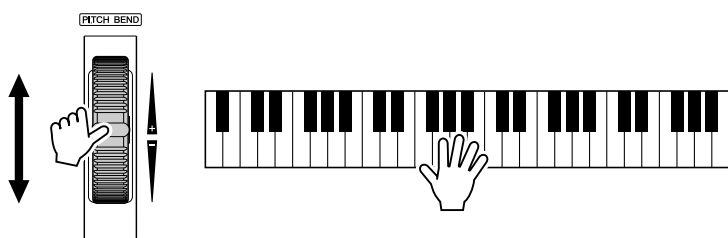

Touch and Touch Sensitivity

The Touch function gives you dynamic, expressive control over the voices, letting you determine how loud or soft the sound is by your playing strength.

Turn the Touch function on or off as desired by pressing the [TOUCH] button.

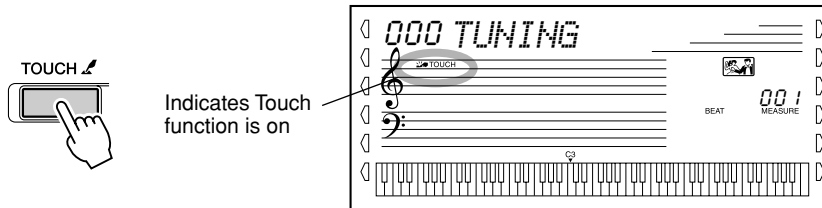

Touch Sensitivity lets you set how the DGX-500/300 responds to your playing strength, allowing you to customize this expressive function to suit your own playing style.

1 Select the Touch Sensitivity control.

Press and hold the [TOUCH] button until the Touch Sensitivity setting and name appears in the display.

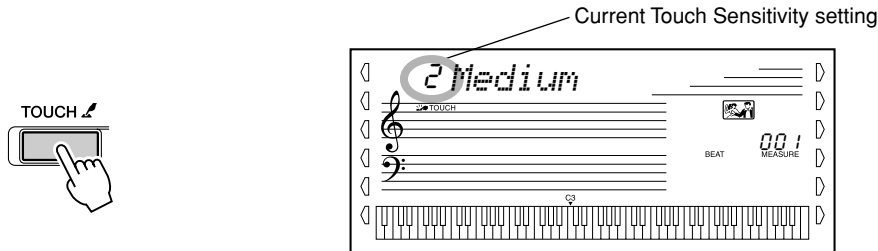

2 Change the value.

Use the numeric keypad or [+]/[-] buttons to set the desired setting: 1, 2, or 3 (explained below).

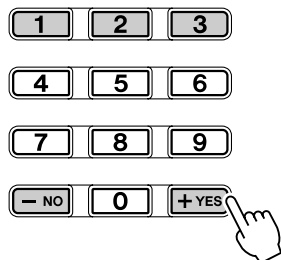

● Settings:

1 (Soft)	This results in limited touch response, and produces a relatively narrow dynamic range, no matter how lightly or strongly you play the keys.
2 (Medium)	This lets you play over a normal dynamic range (soft to loud).
3 (Hard)	This is designed for playing very soft passages, giving you slightly more detailed control in the soft volume range.

When Touch is turned off, a constant volume (corresponding to a velocity value of 80) is produced.

Restoring the Default Touch Sensitivity Value

The default Touch Sensitivity is 2 (Medium). To restore the default value, press both [+]/[-] buttons simultaneously (when Touch Sensitivity is selected).



The DGX-500/300 is equipped with a wide variety of effects that can be used to enhance the sound of the voices. The DGX-500/300 has three separate effect systems — Reverb, DSP, and Harmony — and each has many different effect types to choose from.

Reverb

The Reverb effect reproduces the natural ambient “wash” of sound that occurs when a instrument is played in a room or concert hall. A total of eight different Reverb types simulating various different performance environments are available.

1 Select the Reverb function.

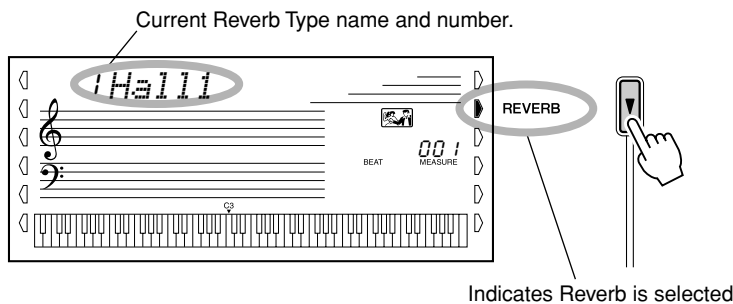

NOTE

- Twelve additional Reverb Types are available when controlling the DGX-500/300 from a MIDI device. (For details, See page 104.)

2 Set the Reverb Type, if desired.

Use the numeric keypad or [+]/[-] buttons to set the desired Reverb Type. (For a list of the available Reverb Types, see page 36.) To turn the Reverb effect off, select Reverb Type #9.

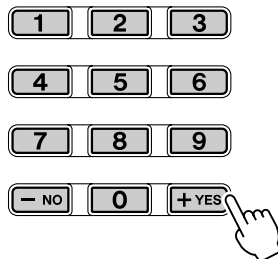

NOTE

- Each style of the DGX-500/300 has its own independent Reverb setting.
- You can also determine the Reverb level. (See page 26.)

Restoring the Default Reverb Type

If you've changed the Reverb Type, you can instantly restore the default setting by pressing both [+]/[-] buttons simultaneously (when Reverb is selected).

DSP

The DSP effect section provides distortion and chorus effects, plus a wealth of other useful and dynamic effects for enhancing and changing the sound of the voices. Included among these miscellaneous effects are reverse gate reverb, phaser, rotary speaker, tremolo, echo, delay, distortion, equalization, and wah. A total of thirty-eight DSP types are available.

1 Select the DSP function.

Press the right Overall button, repeatedly if necessary, until the dark bar indication appears next to DSP.

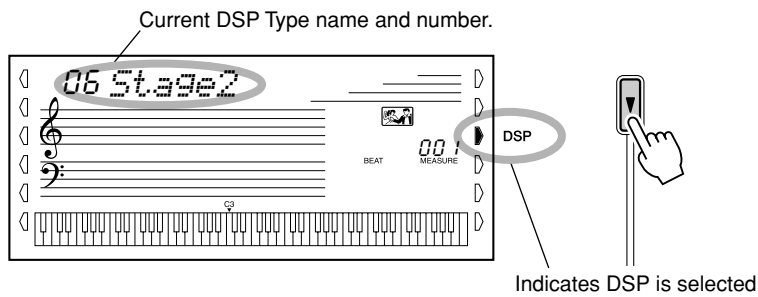

2 Set the DSP Type, if desired.

Use the numeric keypad or [+]/[-] buttons to set the desired DSP Type. (For a list of the available DSP Types, see page 36.) To turn the DSP effect off, select DSP Type #39.

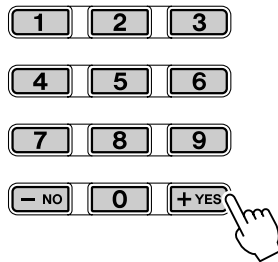

NOTE

- Each voice of the DGX-500/300 has its own independent DSP setting.
- Fifty-one additional DSP Types are available when controlling the DGX-500/300 from a MIDI device. (For details, see page 104.)
- You can also determine the DSP level. (See Page 26.)

Restoring the Default DSP Type

If you've changed the DSP Type, you can instantly restore the default setting by pressing both [+]/[-] buttons simultaneously (when DSP is selected).

Harmony

The Harmony section features a variety of performance effects that enhance the melodies you play when using the accompaniment styles of the DGX-500/300. A total of twenty-six Harmony types are available.

Trill, Tremolo and Echo types can be used even if accompaniment is off. There are five different Harmony Types that automatically create harmony parts (for notes played in the upper section of the keyboard) to match the accompaniment chords.

- 1 Turn on the Harmony effect.**
Press the [HARMONY] button.



- 2 Select the Harmony function.**

Press the right Overall button, repeatedly if necessary, until the dark bar indication appears next to HARMONY.

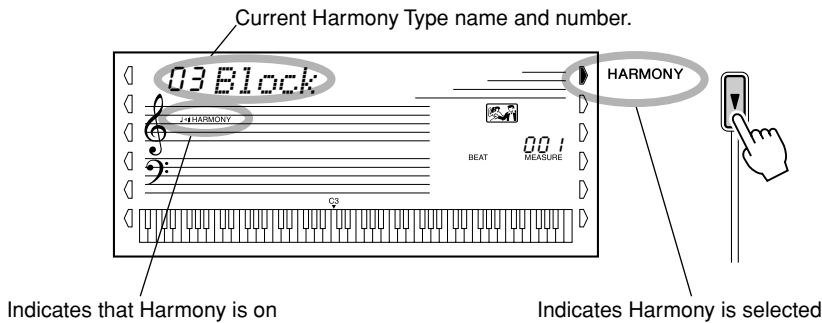

IMPORTANT

- For the first five Harmony Types (Duet, Trio, Block, Country, and Octave), chords must be played in the Accompaniment area of the keyboard.
- The speed of the Trill, Tremolo, and Echo effects depends on the Tempo setting (page 37).

NOTE

- Each voice of the DGX-500/300 has its own independent Harmony setting.

- 3 Set the Harmony Type, if desired.**

Use the numeric keypad or [+]/[-] buttons to set the desired Harmony Type. (For a list of the available Harmony Types, see page 37.)

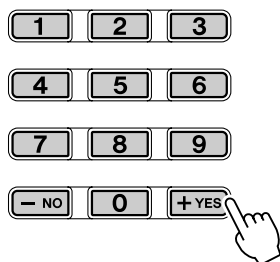

Restoring the Default Harmony Type

If you've changed the Harmony Type, you can instantly restore the default setting by pressing both [+]/[-] buttons simultaneously (when Harmony is selected).

■ Effect Types





















● Reverb Types

No.	Reverb Type	Display Name	Description
1	Hall 1	Hall1	Concert hall reverb.
2	Hall 2	Hall1	
3	Room 1	Room1	Small room reverb.
4	Room 2	Room2	
5	Stage 1	Stage1	Reverb for solo instruments.
6	Stage 2	Stage2	
7	Plate 1	Plate1	Simulated steel plate reverb.
8	Plate 2	Plate2	
9	Off	Off	No effect.

● DSP Types

No.	DSP Type	Display Name	Description
1	Hall 1	Hall1	Concert hall reverb.
2	Hall 2	Hall2	
3	Room 1	Room1	Small room reverb.
4	Room 2	Room2	
5	Stage 1	Stage1	Reverb for solo instruments.
6	Stage 2	Stage2	
7	Plate 1	Plate1	Simulated steel plate reverb.
8	Plate 2	Plate2	
9	Early Reflection 1	ER1	Early reflections only.
10	Early Reflection 2	ER2	
11	Gate Reverb	Gate1	Gated reverb effect, in which the reverberation is quickly cut off for special effects.
12	Reverse Gate	Gate2	Similar to Gate Reverb, but with a reverse increase in reverb.
13	Chorus 1	Chorus1	Conventional chorus effect with rich, warm chorusing.
14	Chorus 2	Chorus2	
15	Flanger 1	Flanger1	Pronounced three-phase modulation with slight metallic sound.
16	Flanger 2	Flanger2	
17	Symphonic	Symphony	Exceptionally rich & deep chorusing.
18	Phaser	Phaser	Pronounced, metallic modulation with periodic phase change.
19	Rotary Speaker 1	Rotary1	Rotary speaker simulation.
20	Rotary Speaker 2	Rotary2	
21	Tremolo 1	Tremolo1	Rich Tremolo effect with both volume and pitch modulation.
22	Tremolo 2	Tremolo2	
23	Guitar Tremolo	Guitar Tremolo	Simulated electric guitar tremolo.
24	Auto Pan	AutoPan	Several panning effects that automatically shift the sound position (left, right, front, back).
25	Auto Wah	AutoWah	Repeating filter sweep "wah" effect.
26	Delay Left - Center - Right	DelayLCR	Three independent delays, for the left, right and center stereo positions.
27	Delay Left - Right	DelayLR	Initial delay for each stereo channel, and two separate feedback delays.
28	Echo	Echo	Stereo delay, with independent feedback level settings for each channel.
29	Cross Delay	CrossDly	Complex effect that sends the delayed repeats "bouncing" between the left and right channels.
30	Karaoke	Karaoke	Deep, pronounced echo effect.
31	Distortion Hard	D Hard	Hard-edged, warm distortion.
32	Distortion Soft	D Soft	Soft, warm distortion.
33	Overdrive	Overdrv	Natural distortion, like that of an overdriven amplifier.
34	Amp Simulation	AmpSimu	Characteristic sound of a guitar amplifier/speaker.
35	EQ Disco	EQ Disco	Equalizer effect that boosts both high and low frequencies, as is typical in most disco music.
36	EQ Telephone	EQ Tel	Equalizer effect that cuts both high and low frequencies, to simulate the sound heard through a telephone receiver.
37	3Band EQ	3BandEQ	Equalizer with three separate frequency bands.
38	2Band EQ	2BandEQ	Equalizer with two separate frequency bands.
39	No Effect	Off	No effect

● Harmony Types

No.	Harmony Type	Display Name		Description
1	Duet	Duet		Harmony types 1 - 5 are pitch-based and add one-, two- or three-note harmonies to the single-note melody played in the right hand. These types only sound when chords are played in the auto accompaniment area of the keyboard.
2	Trio	Trio		
3	Block	Block		
4	Country	Country		
5	Octave	Octave		
6	Trill 1/4 note	Tril1/4		<p>Types 6 - 26 are rhythm-based effects and add embellishments or delayed repeats in time with the auto accompaniment. These types sound whether the auto accompaniment is on or not; however, the actual speed of the effect depends on the Tempo setting (page 44). The individual note values in each type let you synchronize the effect precisely to the rhythm. Triplet settings are also available: 1/6 = quarter-note triplets, 1/12 = eighth-note triplets, 1/24 = sixteenth-note triplets.</p> <ul style="list-style-type: none"> • The Trill effect Types (6 - 12) create two-note trills (alternating notes) when two notes are held. • The Tremolo effect Types (13 - 19) repeat all held notes (up to four). • The Echo effect Types (20 - 26) create delayed repeats of each note played.
7	Trill 1/6 note	Tril1/6		
8	Trill 1/8 note	Tril1/8		
9	Trill 1/12 note	Tril1/12		
10	Trill 1/16 note	Tril1/16		
11	Trill 1/24 note	Tril1/24		
12	Trill 1/32 note	Tril1/32		
13	Tremolo 1/4 note	Trem1/4		
14	Tremolo 1/6 note	Trem1/6		
15	Tremolo 1/8 note	Trem1/8		
16	Tremolo 1/12 note	Trem1/12		
17	Tremolo 1/16 note	Trem1/16		
18	Tremolo 1/24 note	Trem1/24		
19	Tremolo 1/32 note	Trem1/32		
20	Echo 1/4 note	Echo1/4		
21	Echo 1/6 note	Echo1/6		
22	Echo 1/8 note	Echo1/8		
23	Echo 1/12 note	Echo1/12		
24	Echo 1/16 note	Echo1/16		
25	Echo 1/24 note	Echo1/24		
26	Echo 1/32 note	Echo1/32		



Selecting and Playing Styles

The DGX-500/300 provides dynamic rhythm/accompaniment patterns (styles) — as well as voice settings appropriate for each style — for various popular musical categories.

A total of 135 different styles are available, in several different categories. Each style is made up of separate “sections” — Intro, Main A and B, and Ending — letting you call up different accompaniment sections as you perform.

The style features that are built into the rhythms add the excitement of instrumental backing to your performance, letting you control the accompaniment by the chords you play. Auto accompaniment effectively splits the keyboard into two areas: The upper is used for playing a melody line, and the lower (set by default to keys F#2 and lower) is for the auto accompaniment function.

The DGX-500/300 also features the convenient Dictionary function (page 50). Dictionary provides you with a built-in “chord encyclopedia” that teaches you how to play any chord you specify by showing you the appropriate notes in the display.

The DGX-500/300 can also be used with the included disk or commercially available Style File data, allowing you to load additional styles (auto accompaniment patterns) to the instrument. Style File data is loaded individually as style number 136, and can be played just like the preset styles.

Selecting a Style

1 Press the [STYLE] button.

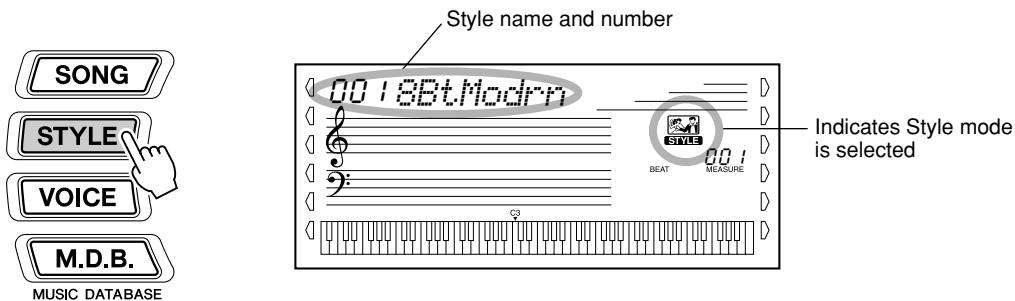

2 Select the desired style number.

Use the numeric keypad. The basic categories of styles and their numbers are shown at the left of the panel. A complete list of the available styles is given on page 98.

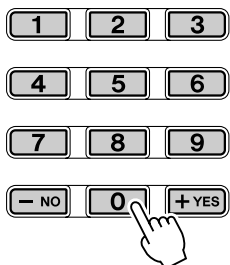

STYLE

001~010	8 BEAT	061~070	R & B	124~135	PIANIST
011~018	16 BEAT	071~077	COUNTRY	136	DISK
019~026	BALLAD	078~089	LATIN		
027~040	DANCE	090~100	BALLROOM		
041~047	DISCO	101~111	TRADITIONAL		
048~060	SWING & JAZZ	112~118	WALTZ		
		119~123	DJ		

Style numbers can be selected in the same way as with the voices (see page 25). You can use the numeric keypad to directly enter the style number, or use the [+]/[-] buttons to step up and down through the styles.

Playing the styles

The panel buttons below function as style controls.

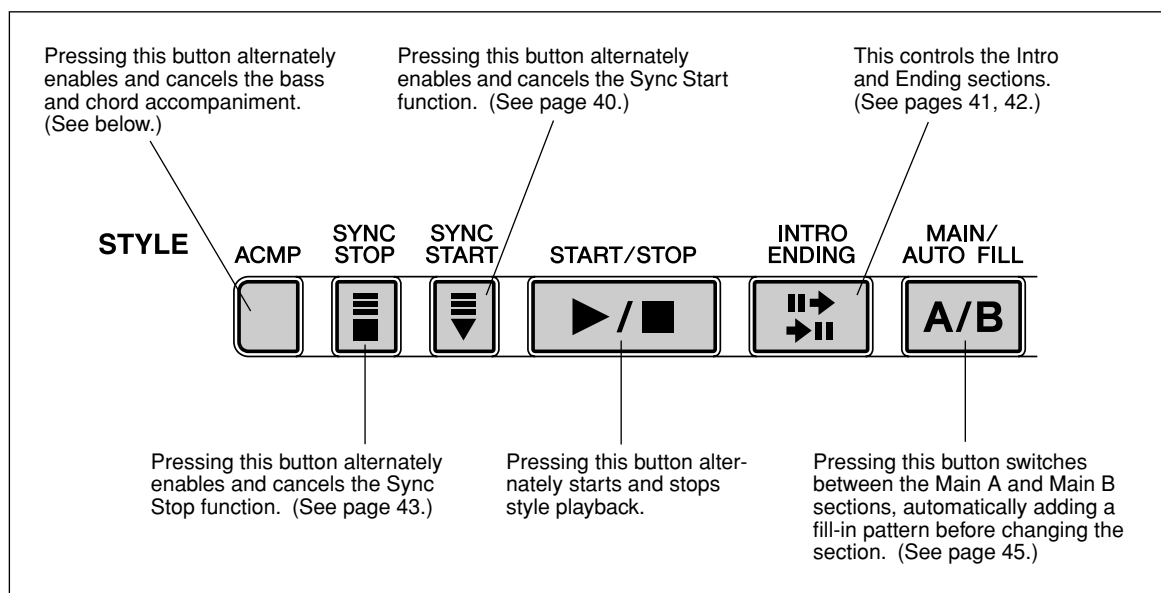

1 Turn on the auto accompaniment.

Press the [ACMP] button to turn on (enable) the auto accompaniment.

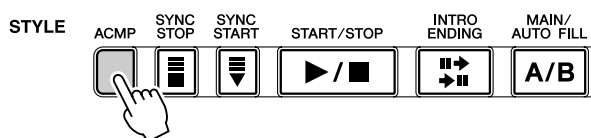

Indicates that auto accompaniment is on.

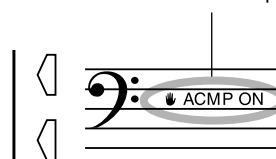

2 Start the style.

You can do this in one of the following ways:

■ Pressing the [START/STOP] button

The rhythm starts playing immediately without bass and chord accompaniment. The currently selected Main A or B section will play.

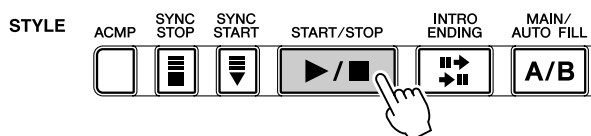

Selecting and Playing Styles

You can select the Main A or B section by pressing the appropriate button — [MAIN A/B] — before pressing the [START/STOP] button. (The display briefly shows the letter of the selected section: “MAIN A” or “MAIN B.”)

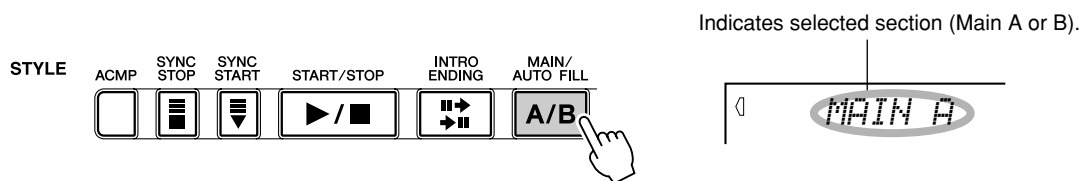

■ Using Tap Tempo to Start

This useful feature lets you tap out the speed (tempo) of the style and automatically start the style at that tapped speed.

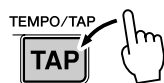

Simply tap the [TEMPO/TAP] button four times (or three times for a 3/4 time style), and the style starts automatically at the tempo you tapped. You can also change the tempo while the style is playing by tapping the [TEMPO/TAP] button twice at the desired tempo.

■ Using Sync Start

The DGX-500/300 also has a Sync Start function that allows you to start the style by simply pressing a key on the keyboard. To use Sync Start, first press the [SYNC START] button (the beat marks all flash to indicate Sync Start stand-by), then press any key on the keyboard. (When auto accompaniment is on, play a key or chord in the auto accompaniment area of the keyboard.)

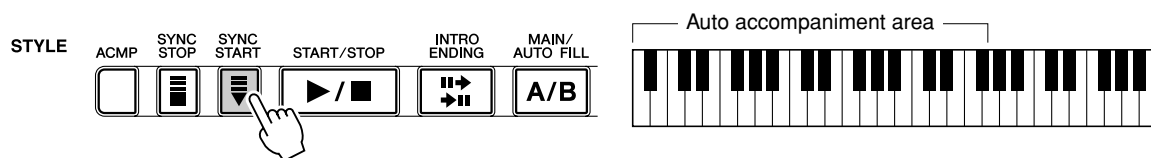

Starting with an Intro section

Each style has its own two- or four-measure Intro section. When used with the auto accompaniment, many of the Intro sections also include special chord changes and embellishments to enhance your performance.

To start with an Intro section:

- 1) Press the [MAIN/AUTO FILL] button — to select which section (A or B) is to follow the Intro.

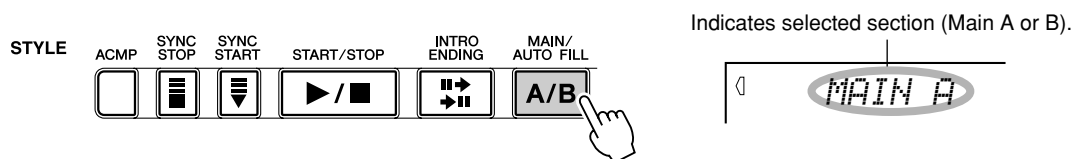

- 2) Press the [INTRO ENDING] button.

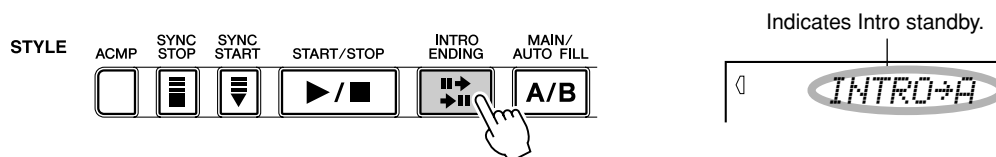

To actually start the Intro section, press the [START/STOP] button.

Using Sync Start with an Intro section

You can also use the Sync Start function with the special Intro section of the selected style.

To use Sync Start with an Intro section:

- 1) Press the [MAIN/AUTO FILL] button — to select which section (A or B) is to follow the Intro.

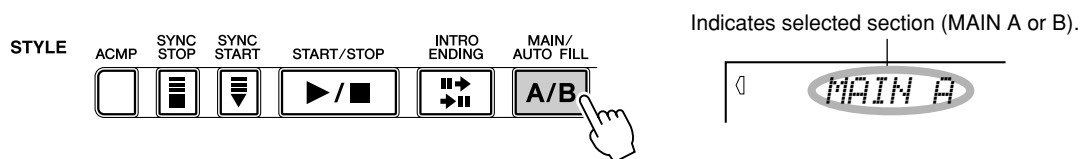

- 2) Press the [INTRO ENDING] button.

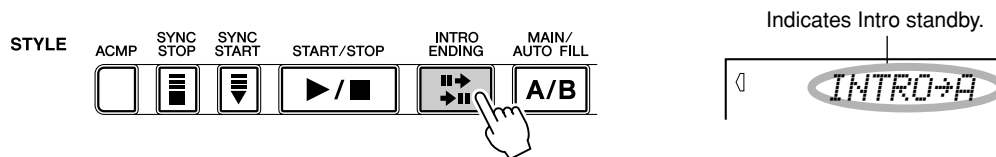

- 3) Press the [SYNC START] button to enable Sync Start, and start the Intro section by playing any key on the keyboard. (When auto accompaniment is on, play a key or chord in the auto accompaniment area of the keyboard.)

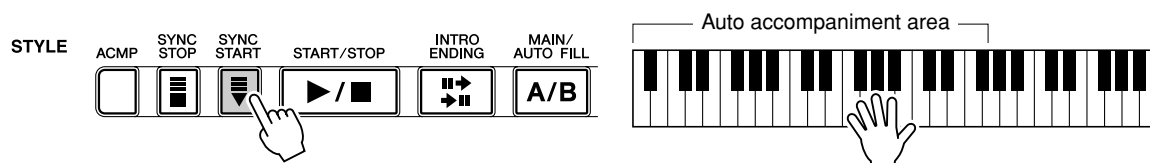

3 Change chords using the auto accompaniment feature.

Try playing a few successive chords with your left hand, and notice how the bass and chord accompaniment change with each chord you play. (Refer to page 47 for more information on how to use auto accompaniment.)

HINT

- The [ACMP] button can also be used to turn off and on the bass/chord accompaniment while playing — allowing you to create dynamic rhythmic breaks in your performance.
- You can use the Sync Stop function to create a similar, yet even more dramatic break. With Sync Stop on (page 43), you can control breaks in the rhythm and accompaniment simply by releasing your fingers from the keys. As long as you play and hold a chord, the accompaniment continues. When you release it, the accompaniment stops. You can also use this feature to create exciting rhythmic stutter effects, chord hits, and accents by playing staccato chords.

NOTE

- Chords played in the auto accompaniment area of the keyboard are also detected and played when the style is stopped. In effect, this gives you a “split keyboard,” with bass and chords in the left hand and the normally selected voice in the right.

4 Stop the style.

You can do this in one of three ways:

■ Pressing the [START/STOP] button

The style stops playing immediately.

■ Using an Ending section

Press the [INTRO ENDING] button. The style stops after the Ending section is finished.

■ Pressing the [SYNC START] button

This immediately stops style and automatically enables Sync Start, letting you re-start the style by simply playing a chord or key in the auto accompaniment area of the keyboard.

NOTE

- To have the Ending section gradually slow down (*ritardando*) as it is playing, press the [INTRO ENDING] button twice quickly.

Sync Stop

This convenient feature lets you stop (or pause) the style by releasing your fingers from the auto accompaniment area of the keyboard. Playing the chord again restarts the style. This is ideal for putting dynamic breaks in your performance — for example, stopping the rhythm and accompaniment briefly while you play a melodic break or solo with your right hand.

1 Press the [ACMP] button.

To turn accompaniment on.

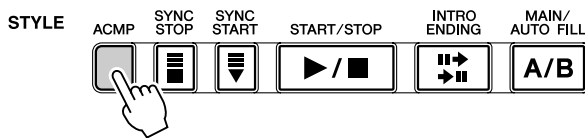

Indicates that auto accompaniment is on.

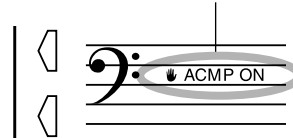

2 Press the [SYNC STOP] button.

Setting Sync Stop to on before starting the style automatically sets Sync Start to on as well, letting you immediately start the style by playing the keyboard.

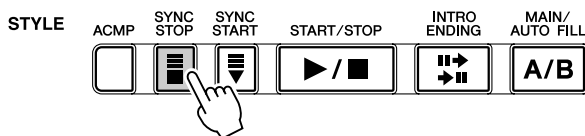

Indicates that Sync Stop is on.

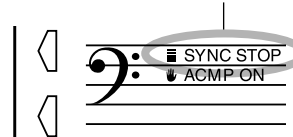

3 Play a chord on the keyboard (in the auto accompaniment area of the keyboard).

The style starts as soon as you play a chord.

4 Stop the style by releasing the chord.

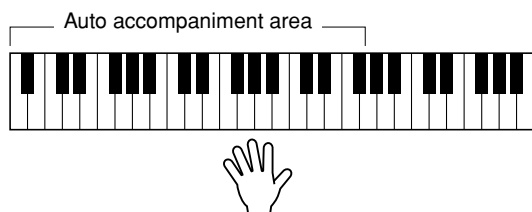

5 To start the style again, play a chord.

To turn Sync Stop off, press the [SYNC STOP] button again. To stop the style completely, press the [START/STOP] button.

Changing the Tempo

The tempo of style playback can be adjusted over a range of 32 - 280 bpm (beats per minute).

1 Call up the Tempo setting.

Press the [TEMPO/TAP] button.

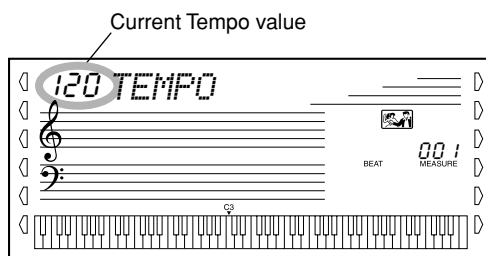

NOTE

- When style playback is stopped and a different style is selected, the tempo returns to the default setting of the new style. When switching styles during playback, the last tempo setting is maintained. (This allows you to keep the same tempo, even when changing styles.)

2 Change the value.

Use the numeric keypad to set the desired Tempo value, or use the [+]/[-] buttons to increase or decrease the value.

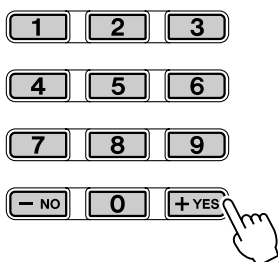

Restoring the Default Tempo Value

- Each song and style has been given a default or standard Tempo setting. If you've changed the Tempo, you can instantly restore the default setting by pressing both [+]/[-] buttons simultaneously (when Tempo is selected).

HINT

- You can also use the convenient Tap Tempo function to change the tempo by "tapping" a new one in real time. (See page 40.)

MAIN/AUTO FILL (Main A/B and Fill-ins)

While the style is playing, you can add variation in the rhythm/accompaniment by pressing the [MAIN/AUTO FILL] button. This switches between the Main A and Main B sections, automatically playing a fill-in pattern to smoothly lead into the next section. For example, if the Main A section is currently playing, pressing this button automatically plays a fill-in pattern, followed by the Main B section. (See below.)

You can also select either the Main A or B section to start by pressing the [MAIN/AUTO FILL] button before starting the style.

NOTE

- Rhythm sounds and fill-in sections are not available when one of the Pianist styles (#124 - #135) are selected.

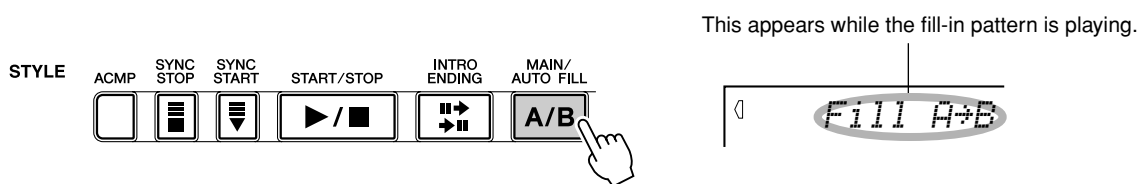

About the Fill-in Patterns

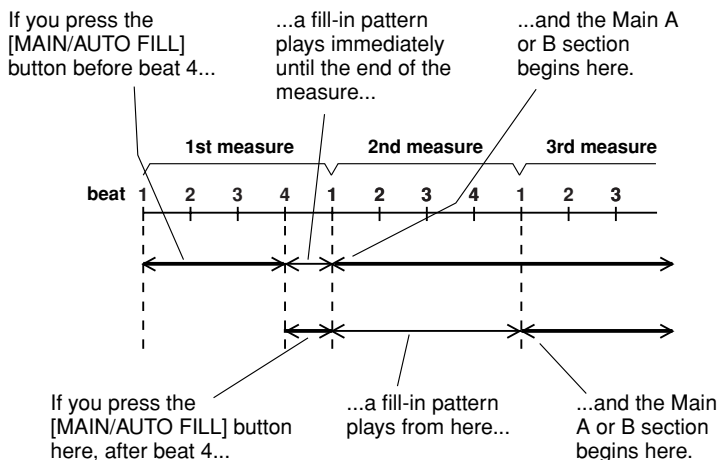

Selecting and Playing Styles

Adjusting the Accompaniment Volume

The playback volume of the style can be adjusted. This volume control affects only the accompaniment volume. The volume range is 000 - 127.

1 Select the Accompaniment Volume function.

Press the left Overall button, repeatedly if necessary, until “ACMP VOL” appears in the display.

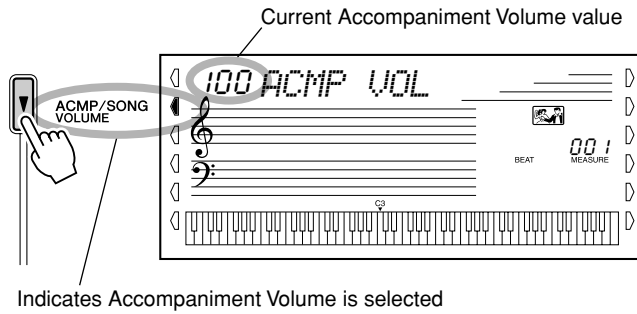

2 Change the value.

Use the numeric keypad to set the desired Accompaniment Volume value (000 - 127). You can also use the [+]/[-] buttons to increase or decrease the value. Holding down either button continuously increases or decreases the value.

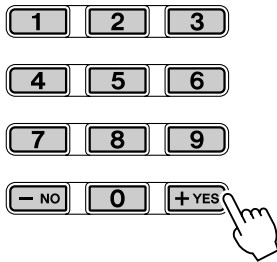

NOTE

- Accompaniment Volume cannot be changed unless the Style mode is active.

Restoring the Default Accompaniment Volume Value



If you've changed the Accompaniment Volume setting, you can instantly restore the default setting of "100" by pressing both [+]/[-] buttons simultaneously (when Accompaniment Volume is selected).

Using Auto Accompaniment — Multi Fingering

When it is set to on (page 39), the auto accompaniment function automatically generates bass and chord accompaniment for you to play along with, by using Multi Fingering operation. You can change the chords of the accompaniment by playing keys in the auto accompaniment area of the keyboard using either the “Single Finger” or “Fingered” method. With Single Finger you can simply play a one-, two- or three-finger chord indication (see Single Finger Chords below). The Fingered technique is that of conventionally playing all the notes of the chord. Whichever method you use, the DGX-500/300 “understands” what chord you indicate and then automatically generates the accompaniment.

■ Single Finger Chords

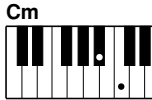

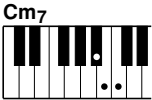







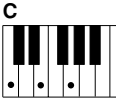
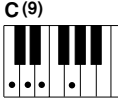
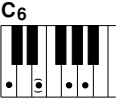
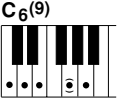
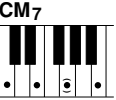
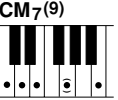
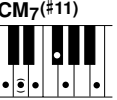
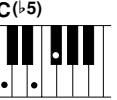
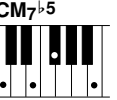





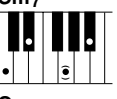
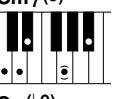
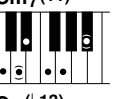





Chords that can be produced in Single Finger operation are major, minor, seventh and minor seventh. The illustration shows how to produce the four chord types. (The key of C is used here as an example; other keys follow the same rules. For example, B \flat 7 is played as B \flat and A.)

 <p>C</p>	 <p>Cm</p>	 <p>C7</p>	 <p>Cm7</p>
<p>To play a major chord: Press the root note of the chord.</p>	<p>To play a minor chord: Press the root note together with the nearest black key to the left of it.</p>	<p>To play a seventh chord: Press the root note together with the nearest white key to the left of it.</p>	<p>To play a minor seventh chord: Press the root note together with the nearest white and black keys to the left of it (three keys altogether).</p>

■ Fingered Chords

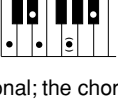
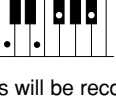
Using the key of C as an example, the chart below shows the types of chords that can be recognized in the Fingered mode.

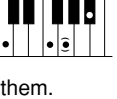
● Example for “C” chords

* Notes enclosed in parentheses are optional; the chords will be recognized without them.

Selecting and Playing Styles

Chord Name/[Abbreviation]	Normal Voicing	Chord (C)	Display
Major [M]	1 - 3 - 5	C	C
Add ninth [(9)]	1 - 2 - 3 - 5	C(9)	C(9)
Sixth [6]	1 - (3) - 5 - 6	C6	C6
Sixth ninth [6(9)]	1 - 2 - 3 - (5) - 6	C6(9)	C6(9)
Major seventh [M7]	1 - 3 - (5) - 7 or 1 - (3) - 5 - 7	CM7	CM7
Major seventh ninth [M7(9)]	1 - 2 - 3 - (5) - 7	CM7(9)	CM7(9)
Major seventh add sharp eleventh [M7(#11)]	1 - (2) - 3 - #4 - 5 - 7 or 1 - 2 - 3 - #4 - (5) - 7	CM7(#11)	CM7(#11)
Flatted fifth [(b5)]	1 - 3 - b5	C(b5)	Cb5
Major seventh flatted fifth [M7b5]	1 - 3 - b5 - 7	CM7b5	CM7b5
Suspended fourth [sus4]	1 - 4 - 5	Csus4	Csus4
Augmented [aug]	1 - 3 - #5	Caug	Caug
Major seventh augmented [M7aug]	1 - (3) - #5 - 7	CM7aug	CM7aug
Minor [m]	1 - b3 - 5	Cm	Cm
Minor add ninth [m(9)]	1 - 2 - b3 - 5	Cm(9)	Cm(9)
Minor sixth [m6]	1 - b3 - 5 - 6	Cm6	Cm6
Minor seventh [m7]	1 - b3 - (5) - b7	Cm7	Cm7
Minor seventh ninth [m7(9)]	1 - 2 - b3 - (5) - b7	Cm7(9)	Cm7(9)
Minor seventh add eleventh [m7(11)]	1 - (2) - b3 - 4 - 5 - (b7)	Cm7(11)	Cm7(11)
Minor major seventh [mM7]	1 - b3 - (5) - 7	CmM7	CmM7
Minor major seventh ninth [mM7(9)]	1 - 2 - b3 - (5) - 7	CmM7(9)	CmM7(9)
Minor seventh flatted fifth [m7b5]	1 - b3 - b5 - b7	Cm7b5	Cm7b5
Minor major seventh flatted fifth [mM7b5]	1 - b3 - b5 - 7	CmM7b5	CmM7b5
Diminished [dim]	1 - b3 - b5	Cdim	Cdim
Diminished seventh [dim7]	1 - b3 - b5 - 6	Cdim7	Cdim7
Seventh [7]	1 - 3 - (5) - b7 or 1 - (3) - 5 - b7	C7	C7
Seventh flatted ninth [7(b9)]	1 - b2 - 3 - (5) - b7	C7(b9)	C7(b9)
Seventh add flatted thirteenth [7(b13)]	1 - 3 - 5 - b6 - b7	C7(b13)	C7(b13)
Seventh ninth [7(9)]	1 - 2 - 3 - (5) - b7	C7(9)	C7(9)
Seventh add sharp eleventh [7(#11)]	1 - (2) - 3 - #4 - 5 - b7 or 1 - 2 - 3 - #4 - (5) - b7	C7(#11)	C7(#11)
Seventh add thirteenth [7(13)]	1 - 3 - (5) - 6 - b7	C7(13)	C7(13)
Seventh sharp ninth [7(#9)]	1 - #2 - 3 - (5) - b7	C7(#9)	C7(#9)
Seventh flatted fifth [7b5]	1 - 3 - b5 - b7	C7b5	C7b5
Seventh augmented [7aug]	1 - 3 - #5 - b7	C7aug	C7aug
Seventh suspended fourth [7sus4]	1 - 4 - (5) - b7	C7sus4	C7sus4
One plus two plus five [1+2+5]	1 - 2 - 5	C1+2+5	C

NOTE

- Notes in parentheses can be omitted.
- Playing two same root keys in the adjacent octaves produces accompaniment based only on the root.
- A perfect fifth (1 + 5) produces accompaniment based only on the root and fifth which can be used with both major and minor chords.
- The chord fingerings listed are all in "root" position, but other inversions can be used — with the following exceptions:
 - m7, m7b5, 6, m6, sus4, aug, dim7, 7b5, 6(9), 1+2+5.
- Inversion of the 7sus4 and m7(11) chords are not recognized if the notes shown in parentheses are omitted.
- The auto accompaniment will sometimes not change when related chords are played in sequence (e.g. some minor chords followed by the minor seventh).
- Two-note fingerings will produce a chord based on the previously played chord.

Setting the Split Point

The Split Point determines the highest key for the auto accompaniment area. The accompaniment can be played with the keys up to and including the Accompaniment Split Point key.

NOTE

• This setting also affects the split point for the special Split voices.

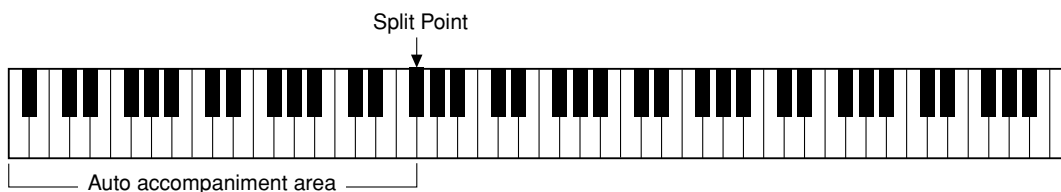

1 Select the Split Point control.

Press and hold the [SPLIT] button until "S_POINT" appears in the display.

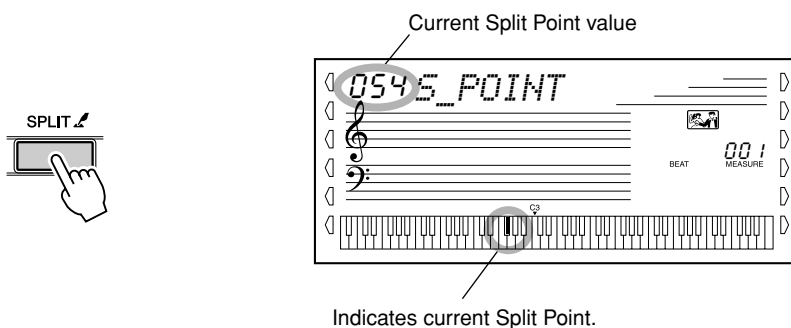

2 Change the value.

Use the numeric keypad or [+]/[-] buttons to set the desired value: 0 (C-2) - 127 (G8).

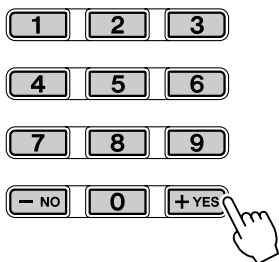

Restoring the Default Split Point Value

If you've changed the Split Point setting, you can instantly restore the default setting of "54" (F#2) by pressing both [+]/[-] buttons simultaneously (when Split Point is selected).

To leave the Split Point function, simply go on to another operation or function.

Dictionary

The Dictionary function is essentially a built-in “chord book” that shows you the individual notes of chords. It is ideal when you know the name of a certain chord and want to quickly learn how to play it.

IMPORTANT

- Pressing the [DICTIONARY] button automatically turns on the auto accompaniment.

1 Press the [DICTIONARY] button.

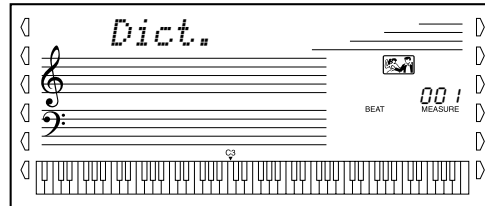

2 Specify the root of the chord.

Press the key on the keyboard that corresponds to the desired chord root (as printed on the panel).

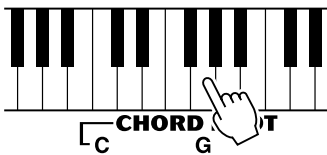

Pressing this key selects the root G.

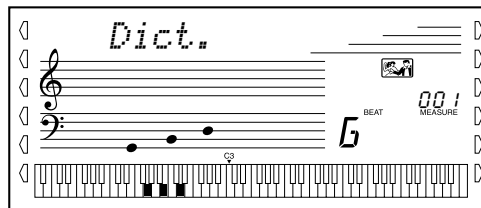

3 Specify the type of the chord (major, minor, seventh, etc.).

Press the key on the keyboard that corresponds to the desired chord type (as printed on the panel).

NOTE

- For a few specific chords, not all notes may be shown in the notation section of the display. This is due to space limitations in the display.
- You can also show the inversion of chord when using [+]/[-] button.

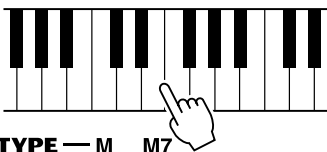

Pressing this key selects the major seventh chord type (M7).

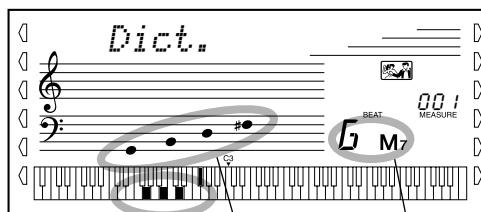

Individual notes of chord (keyboard)
 Notation of chord
 Chord name (root and type)

4 Play the chord.

Play the chord (as indicated in the display) in the auto accompaniment area of the keyboard. The chord name flashes in the display (and a “congratulations” melody is played) when the correct notes are held down. (Inversions for many of the chords are also recognized.)

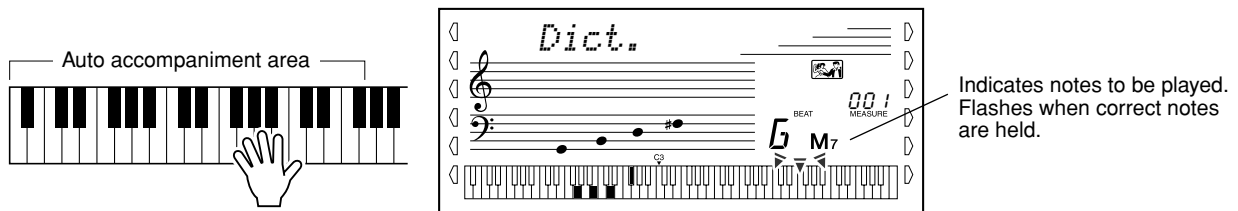

To leave the Dictionary function, press the [DICTIONARY] button again.

..... What is a Chord?

The simple answer: Three or more notes played simultaneously is a chord. (Two notes played together is an “interval” — an interval being the distance between two different notes. This is also referred to as a “harmony.”) Depending on the intervals between the three or more notes, a chord can sound beautiful or muddy and dissonant.



The organization of notes in the example at left — a triad chord — produces a pleasant, harmonious sound. Triads are made up of three notes and are the most basic and common chords in most music.

In this triad, the lowest note is the “root.” The root is the most important note in the chord, because it anchors the sound harmonically by determining its “key” and forms the basis for how we hear the other notes of the chord.

The second note of this chord is four semitones higher than the first, and the third is three semitones higher than the second. Keeping our root note fixed and changing these notes by a semitone up or down (sharp or flat), we can create four different chords.

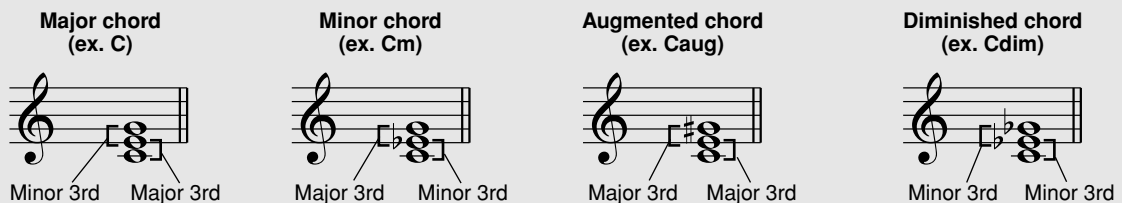

Keep in mind that we can also change the “voicing” of a chord — for example, change the order of the notes (called “inversions”), or play the same notes in different octaves — without changing the basic nature of the chord itself.

Inversion examples for the key of C



Selecting and Playing Styles

Beautiful sounding harmonies can be built in this manner. The use of intervals and chords is one of the most important elements in music. A wide variety of emotions and feelings can be created depending on the types of chords used and the order in which they are arranged.

..... Writing Chord Names

Knowing how to read and write chord names is an easy yet invaluable skill. Chords are often written in a kind of shorthand that makes them instantly recognizable (and gives you the freedom to play them with the voicing or inversion that you prefer). Once you understand the basic principles of harmony and chords, it's very simple to use this shorthand to write out the chords of a song.

First, write the root note of the chord in an uppercase letter. If you need to specify sharp or flat, indicate that to the right of the root. The chord type should be indicated to the right as well. Examples for the key of C are shown below.

Major chord C	Minor chord Cm	Augmented chord Caug	Diminished chord Cdim
-------------------------	--------------------------	--------------------------------	---------------------------------

For simple major chords, the type is omitted.

One important point: Chords are made up of notes “stacked” on top of each other, and the stacked notes are indicated in the chord name of the chord type as a number — the number being the distance of the note from the root. (See the keyboard diagram below.) For example, the minor 6th chord includes the 6th note of the scale, the major 7th chord has the 7th note of the scale, etc.

The Intervals of the Scale

To better understand the intervals and the numbers used to represent them in the chord name, study this diagram of the C major scale:

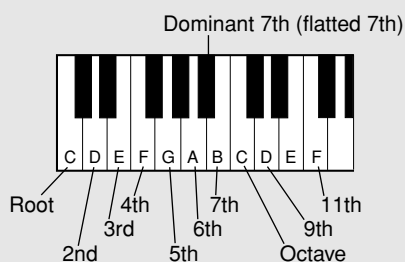

Other Chords

Csus4 5th 4th	C7 Dominant 7th Major chord	Cm7 Dominant 7th Minor chord	CM7 7th Major chord
Cm7b5 Dominant 7th Diminished chord	Cm6 Minor chord 6th	C(9) 9th	Cdim7 Diminished 7th (double flatted 7th) Diminished chord

* Bbb = A



Using the Music Database

If you want to play in a certain genre of music but don't know which style and voice settings would be appropriate, simply select the desired genre from the Music Database. The DGX-500/300 automatically makes all appropriate panel settings to let you play in that music style!

1 Press the [M.D.B.] (MUSIC DATABASE) button.

The MUSIC DATABASE menu appears in the display.

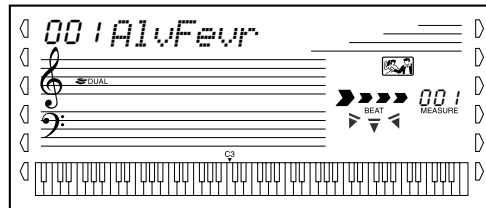
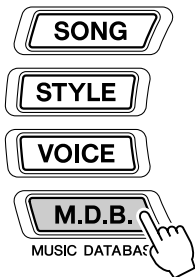

NOTE

- Press the [M.D.B.] (MUSIC DATABASE) button to switch into the Style mode, turn AUTO ACCOMPANIMENT on, and turn SYNCHRONIZED START on. See page 40 for details.

2 Select a "Music Database."

Use the numeric keypad to set the desired Music Database, or use the [+]/[-] buttons to increase or decrease the value.

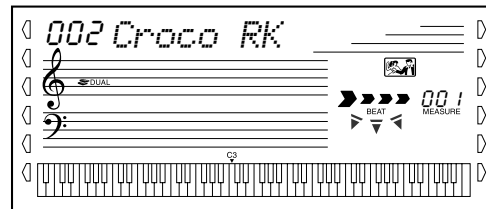
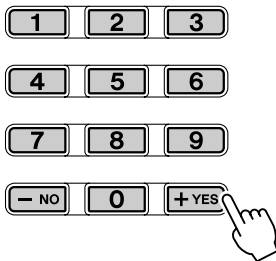

The DGX-500/300 has 208 panel setups in the Music Database and they are divided into 12 different categories.

In this example, we'll select #208 "Xmas Walz" and play the song "Silent Night." (The sheet music is provided on the next page.)

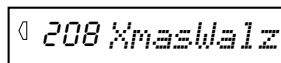

3 Play the chords with your left hand and the melody lines with your right hand along with the music.

As soon as you play a chord with your left hand, the style starts. For information on how to enter chords, see "Multi Fingering" on page 47.

NOTE

- See pages 38 through 49 for details about the Auto Accompaniment.

Using the Music Database

♩ = 82 Silent Night

4 When you reach the point in the music indicated by the arrow above, press the [ENDING] button.

The style plays an ending phrase in ritardando.
 When the ending is finished, the style automatically stops.
 You can also stop the style by using the [STOP] button.

Data stored by the Music Database

Each of the Music Database settings has been specially programmed to match the selected style and each features the best suited voice (or combination of voices), style and other settings. Pressing the [M.D.B.] (MUSIC DATABASE) button and selecting a number lets you instantly reconfigure all relevant settings, conveniently allowing you to start playing in the desired genre with all the appropriate sounds — without having to make each setting one by one. For each parameter, refer to the following pages.

■ VOICE PARAMETERS

MAIN Voice, Volume, Reverb Depth, DSP Depth.....	page 26
Dual On/Off, Voice, Octave, Volume, Reverb Depth, DSP Depth	page 26
• Reverb Type	page 33
• DSP Type	page 34
• Harmony On/Off.....	page 35
• Harmony Type.....	page 37
• Transpose	page 29
• Pitch Bend Range	page 31

■ STYLE PARAMETERS

• Synchro Start=ON*	page 40
• Style Number	page 38
• Accompaniment Split Point	page 49
• Main A/Main B	page 45
• Tempo	page 44
• Accompaniment Volume	page 46

* Set only when the accompaniment is not playing.



Registration Memory

Registration Memory is a flexible and convenient function that lets you instantly reconfigure virtually all settings of the DGX-500/300 with the touch of a single button. Simply save your favorite custom panel settings to one of the Registration Memory presets (up to sixteen are available) for future recall.

Registration Memory Presets

The DGX-500/300 has eight Registration Memory banks, each with two different presets (a total of sixteen) for your custom panel settings. Each of the sixteen Registration Memory can have different settings for the following parameters:

- Voice number
- Tempo
- Transpose
- Reverb Type
- DSP Type
- Harmony On/Off setting and Type
- Split Point
- Style number, and style-related settings: Accompaniment On/Off and Split Point
- Pitch Bend Range

Recording a Registration Memory Preset

1 Make all desired settings for the DGX-500/300.

Virtually all of the DGX-500/300's settings can be saved to a Registration Memory button.

2 Select the desired bank.

Press the [BANK] button, then press the desired bank number (1 - 8).

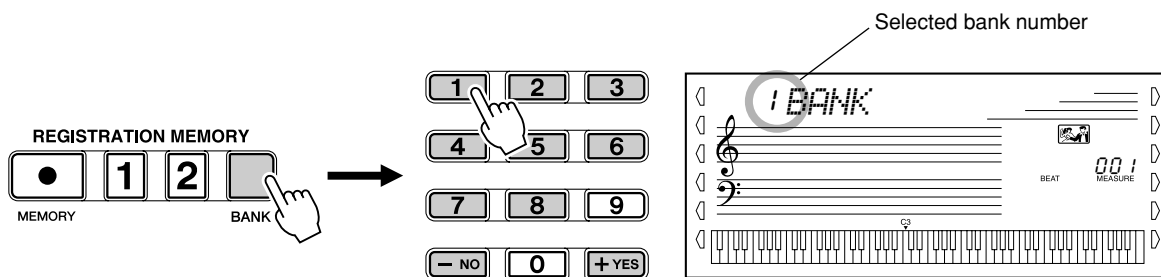

3 Record the settings to the desired preset, 1 or 2.

While holding down the [MEMORY] button, press the appropriate REGISTRATION MEMORY button, [1] or [2].

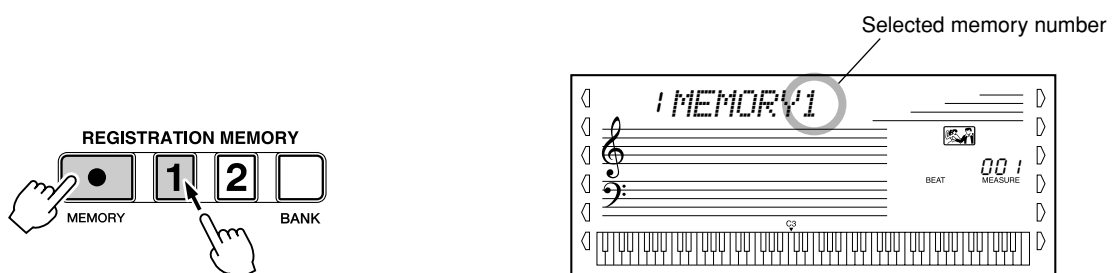

Recalling a Registration Memory Preset

1 Select the appropriate Registration Memory bank.

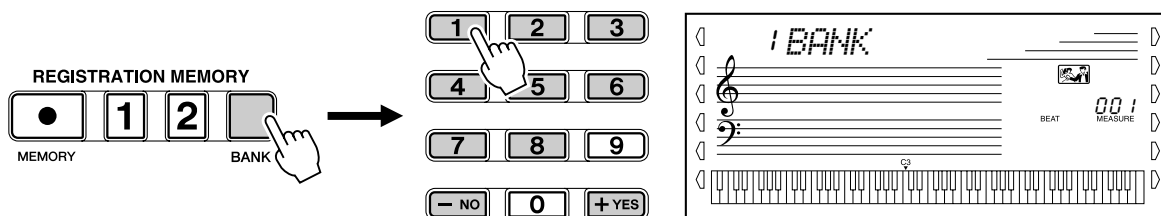

2 Press the desired Registration Memory preset button ([1] or [2]).

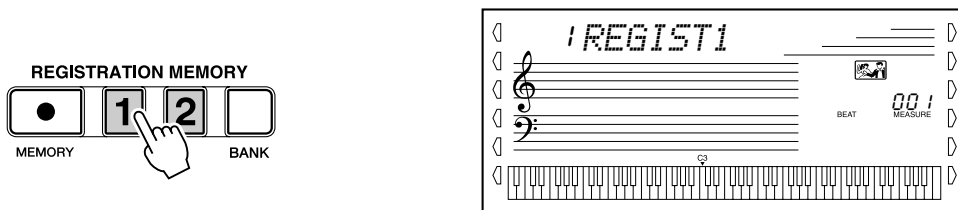



Selecting and Playing Songs

The DGX-500/300 features a total of 105 songs. These include 100 songs that showcase the rich and dynamic sounds of the instrument, and 100 of these songs can be used with the educational Lesson feature (page 67), a powerful tool that makes learning songs fun and easy. Three of the songs are special Demonstration songs that can be played automatically by pressing the [DEMO] button. Moreover, there are five special User songs to which you can record your own performance.

The User songs are “empty” and cannot be played until something has been recorded to them. (For instructions on recording your own songs, see page 62.)

You can also play back songs from floppy disks; for details, see page 73.

● Song Playback Display

Indicates the tracks currently playing back. (These can be alternately muted and sounded during playback by pressing the corresponding SONG MEMORY buttons.)

Current measure number
* The indication “F 1” appears in the display when a song having a “free” tempo is selected. Certain songs have been composed or arranged in “free” tempo, meaning that the tempo and/or the time signature are not constant during the piece. As a result, when a “free” tempo song plays back, the measure, beat and timing indications are not shown in the display.

These display the notes and name of the current chord.

About the Beat Display
The arrow marks in the beat display flash in time with the rhythm of the song or style. The first arrow indicates the first beat of the measure, and the others flash in sequence.

Selecting and Playing a Song

1 Press the [SONG] button.

Song name and number

Indicates Song mode is selected

MUSIC DATABASE

2 Select the desired song number.

Use the numeric keypad.

You can use the numeric keypad to directly enter the song number, or use the [+]/[-] buttons to step up and down through the songs.

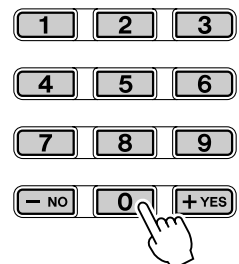

Selecting and Playing Songs

3 Start the selected song.

Press the [START/STOP] button. As the song plays back, the measure number and chords are shown in the display.

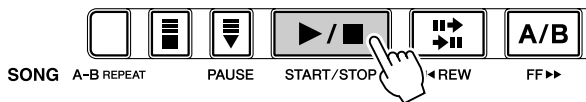

NOTE

- You can play along with the song using the currently selected voice, or even select a different voice for playing along. Simply call up the Voice mode while the song is playing back and select the desired voice. (See page 24.)

4 Stop the song.

Press the [START/STOP] button. If playback was started by pressing the [START/STOP] button, the selected song stops automatically.

A-B Repeat

The convenient A-B Repeat function is an ideal aid for practicing and learning. It allows you to specify a phrase of a song (between point A and point B) and repeat it — while you play or practice along with it.

1 While playing a song, set point A (the start point).

During playback, press the [A-B REPEAT] button once, at the beginning point to be repeated.

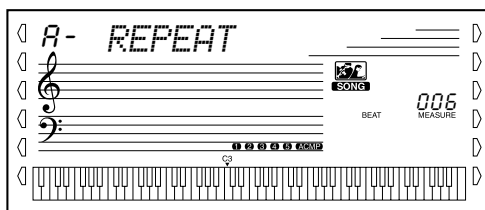
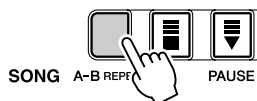

NOTE

- The A and B points can only be specified at the beginning of a measure (beat 1), and not at any point in the middle of a measure.
- To set the A point to the beginning of a song, press the [A-B REPEAT] button before starting playback.

2 Set point B (the end point).

As the song continues playing, press the [A-B REPEAT] button once again, at the ending point to be repeated. The selected phrase repeats indefinitely until stopped.

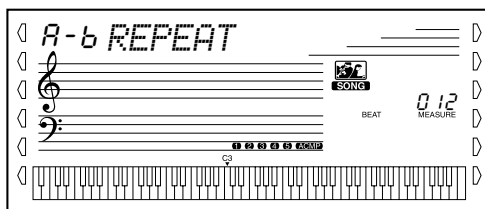
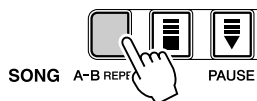

HINT

- If you're repeat practicing a particularly difficult section, try slowing down the Tempo to an appropriate speed to make it easier to play and master the part. You may also want to slow down the Tempo while setting the A and B points; this makes it easier to accurately set the points.
- You can also set the A-B Repeat function when the song is stopped. Simply use the [<< REW] and [FF >>] buttons to select the desired measures, pressing the [A-B REPEAT] button for each point, then start playback.

3 Pause or stop playback as needed.

Use the [PAUSE] button or [START/STOP] button. Stopping playback does not cancel the set A/B points or the A-B Repeat function.

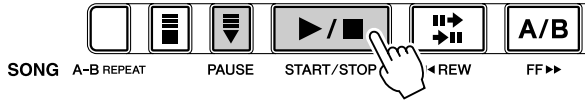

4 Turn off the A-B Repeat function.

Press the [A-B REPEAT] button.

Melody Voice Change

The DGX-500/300 lets you play a melody on the keyboard along with each of the songs, either with the original melody voice or one of your own selection. The convenient Melody Voice Change feature takes this one step further — it lets you replace the original voice used for the melody of the song with the panel voice of your own selection. For example, if the current voice selected on the panel is piano but the song's melody is being played by a flute voice, using Melody Voice Change will change the flute melody voice to piano.

1 Select the desired song.

Press the [SONG] button, then use the numeric keypad or [+] / [-] buttons to select the desired song.

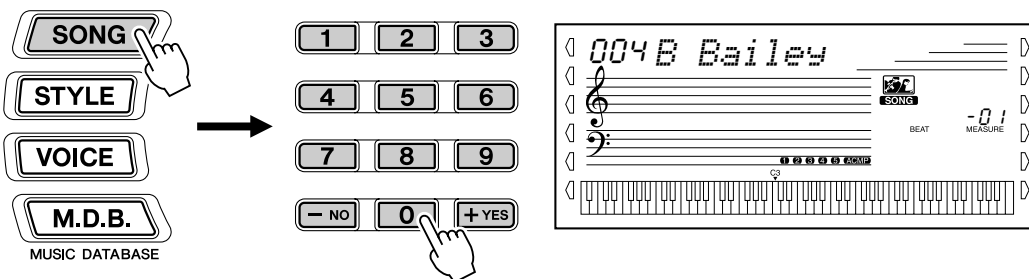

2 Select the desired voice.

Press the [VOICE] button, then use the numeric keypad or [+] / [-] buttons to select the desired voice.

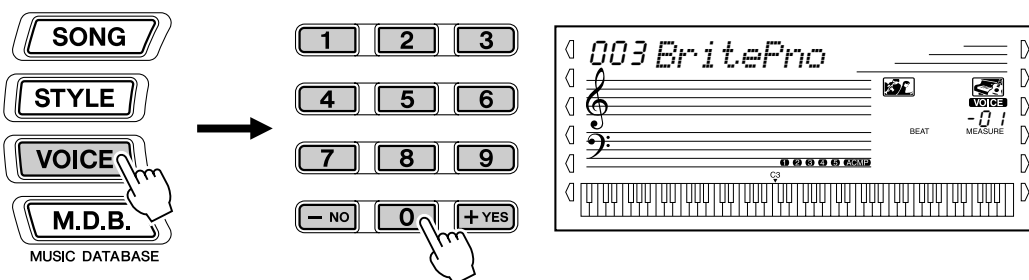

Selecting and Playing Songs

3 Press and hold down the [VOICE] button for at least one second.

“MELODY VOICE CHANGE” appears in the display, indicating that the selected panel voice has replaced the song’s original melody voice.

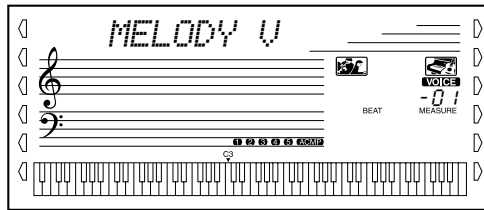

Changing the Tempo

The tempo of song playback can be adjusted over a range of 32 - 280 bpm (beats per minute).

1 Call up the Tempo setting.

Press the [TEMPO/TAP] button.

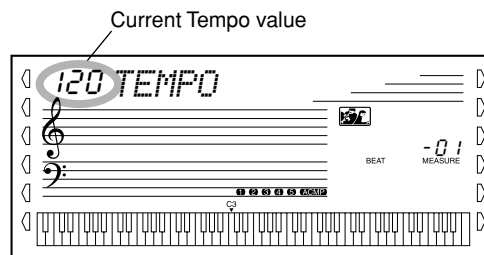

2 Change the value.

Use the numeric keypad to set the desired Tempo value, or use the [+]/[-] buttons to increase or decrease the value.

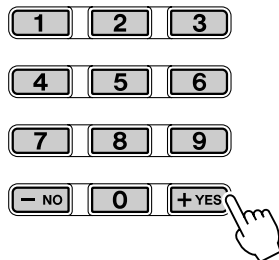

Also, the tempo of a song returns to the default setting when selecting a different song.

Restoring the Default Tempo Value

Each song has been given a default or standard Tempo setting. If you've changed the Tempo, you can instantly restore the default setting by pressing both [+]/[-] buttons simultaneously (when Tempo is selected).

HINT

- You can also use the convenient Tap Tempo function to change the tempo by "tapping" a new one in real time. (See page 40.)

Adjusting the Song Volume

The playback volume of the song can be adjusted. This volume control affects only the song volume. The volume range is 000 - 127.

1 Select the Song Volume function.

Press the left Overall button, repeatedly if necessary, until “SONG VOL” appears in the display.

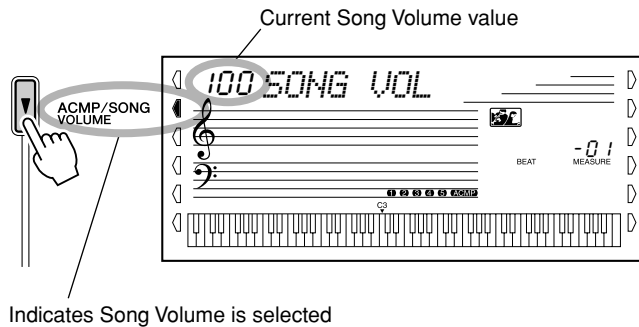

2 Change the value.

Use the numeric keypad to set the desired Song Volume value (000 - 127). You can also use the [+]/[-] buttons to increase or decrease the value. Holding down either button continuously increases or decreases the value.

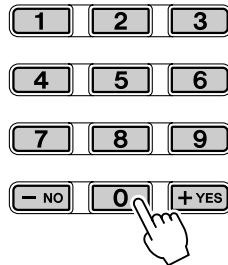

NOTE

- Song Volume cannot be changed unless the Song mode is active. (This function becomes Accompaniment Volume when the Style mode is active.)

Restoring the Default Song Volume Value

If you've changed the Song Volume setting, you can instantly restore the default setting of "100" by pressing both [+]/[-] buttons simultaneously (when Song Volume is selected).



Song Recording

The DGX-500/300 features powerful and easy-to-use song recording features that let you record your keyboard performances — using up to six independent tracks (including one track for accompaniment) — for creating your own complete, fully orchestrated compositions. You can record and save up to five User songs.

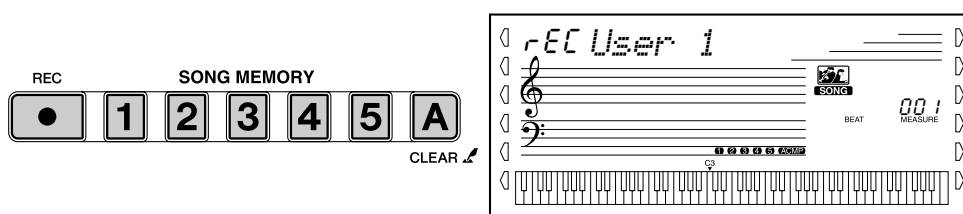

NOTE

Song Memory Capacity

- Maximum number of notes : approximately 10,000 (when only "melody" tracks are recorded)
- Maximum number of chords : approximately 5,500 (when only the accompaniment track is recorded)

Song recording on the DGX-500/300 is similar to using a tape recorder; whatever you play on the keyboard is recorded in real time as you play it. Also, when you record subsequent parts to other tracks, you can hear the previously recorded parts as you record new ones.

Recording a User Song

Data that can be recorded to the normal (melody) tracks:

- Note on/off
- Velocity
- Voice Number
- Reverb Type*
- Chorus Type*
- DSP Type*
- Sustain
- Pitch Bend data
- Tempo*, Time Signature* (if there is no such data in the Accompaniment track)

Data that can be recorded to the Accompaniment track:

- Style number*
- Chord changes and timing
- Changing sections (Intro, Main A/B, etc.)
- Reverb Type*
- DSP Type*
- Accompaniment Volume*
- Tempo, Time Signature*

* These settings can only be recorded once at the beginning of a song; other settings can be changed in the middle of a song.

1 Make all desired DGX-500/300 settings.

Before you actually start recording, you'll need to make various settings for the song — such as selecting a style, setting the Tempo, and selecting a voice. (See pages 38, 44, and 24.)

If desired, also make other settings. Refer to the list above for settings that can be recorded to a song.

Using the Metronome

You can use the Metronome instead of a style if desired. This allows you to keep your performance "in time," even when recording without style. To do this, press the [METRONOME] button before recording in step #4 below. After the song is completely recorded, simply play back the song with the Metronome turned off. (See page 22.)

2 Select a User song number for recording.

Use the numeric keypad to select the desired song: 201 - 205. If no song is manually selected, the DGX-500/300 automatically selects the first available empty song number.

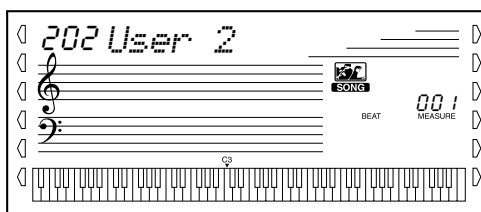
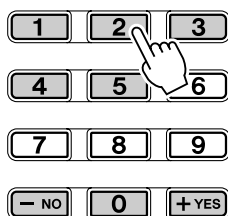

NOTE

- User song numbers can be selected in the same way as with the voices (see page 25). You can use the numeric keypad to directly enter the song number, use the [+]/[-] buttons to step up and down through the songs.

3 Select a track number for recording.

While holding down the [REC] button, press the appropriate SONG MEMORY button.

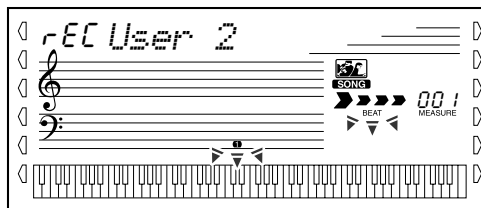

CAUTION

- Keep in mind that all recording operations "replace" the data. In other words, if you record to a track that already has recorded data, all previous data in the track will be erased and replaced by the newly recorded data.

● Muting Tracks During Playback

While recording is enabled, you can selectively mute different tracks. This is useful for when you want to clearly hear certain tracks, and not others, during recording. Muting can also be done "on the fly" during playback. To use muting, press the corresponding SONG MEMORY button, repeatedly if necessary, until the desired track number in the display is off.

Each press of a SONG MEMORY button (when playback is stopped) cycles through the following settings:

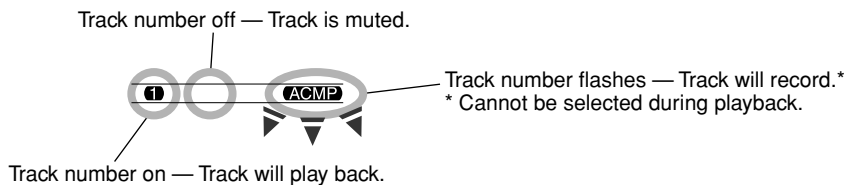

■ Recording to the Accompaniment Track

A special Accompaniment track is provided for recording accompaniment data. This is automatically recorded to the Accompaniment track (track A). Selecting the Accompaniment track automatically turns on the accompaniment.

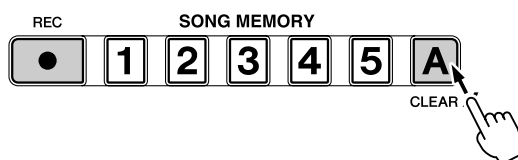

NOTE

- If accompaniment has already been turned on before entering the Record mode, the Accompaniment track is automatically selected.

Song Recording

■ Recording to a Melody Track (1 - 5)

Five independent Melody tracks are provided for recording your keyboard performance. Normally, you'll want to record these after you've recorded the Accompaniment track. You can also record the Accompaniment track and one of the Melody tracks simultaneously.

4 Start recording.

When the beat marks and track number start flashing, you can start recording simply by playing the keyboard (or by pressing the [START/STOP] button).

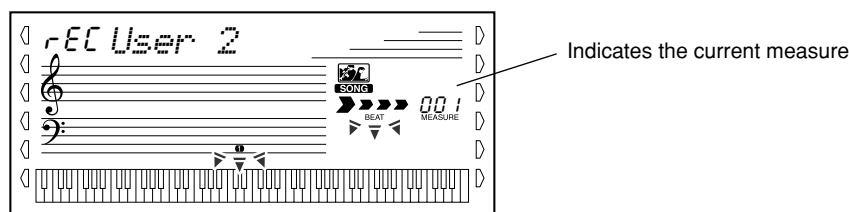

If you want to rehearse your part before recording, press the [SYNC START] button to turn Sync Start off. After rehearsing, press [SYNC START] again to return to the above condition.

■ When recording the Accompaniment track

With Sync Start on, play the first chord of the song in the auto accompaniment area of the keyboard. The accompaniment starts automatically and you can continue recording, playing other chords in time with the accompaniment.

5 Stop recording.

After you've finished playing the part, press the [START/STOP] or [REC] button.

6 Record to other tracks as desired.

To do this, simply repeat steps #3 - #5 above. Make sure that when you press the SONG MEMORY button corresponding to the desired track, the track number in the display flashes.

7 Listen to your new recording.

To play back the song from the beginning, simply press the [START/STOP] button again. Playback stops when the [START/STOP] button is pressed again.

Song Clear

The Song Clear operation completely erases all recorded data on all tracks of a selected User song. Use this operation only when you're sure you want to erase a song and record a new one. To erase an individual track of a song while leaving the other tracks intact, use the Track Clear operation (page 66).

1 Select the desired song.

Press the [SONG] button, then use the numeric keypad or [+]/[-] buttons to select the desired song (201 - 205).

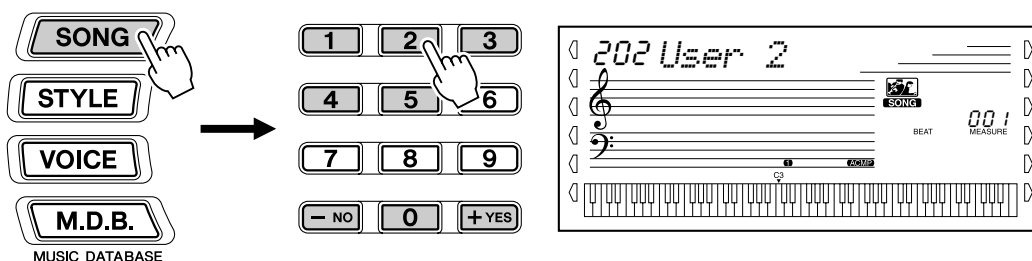

2 While holding down the [A] button, press SONG MEMORY button [1].

All track indications in the display flash, indicating that all tracks are to be erased.

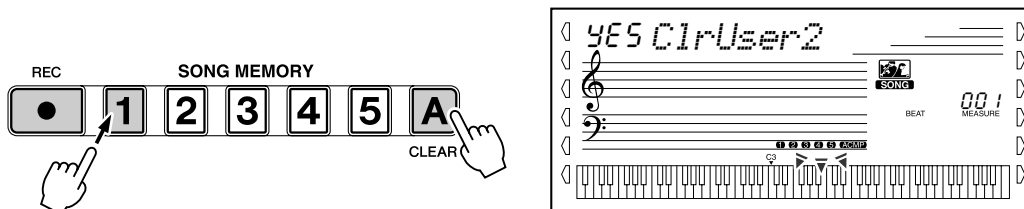

3 Press the [+ / YES] button.

4 At the "Sure?" prompt, press the [+ / YES] button, or press the [- / NO] button to abort.

Pressing the [+ / YES] button executes the Song Clear operation.

Pressing the [- / NO] button aborts.

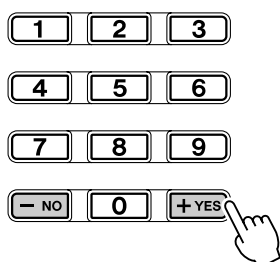

Track Clear

The Track Clear operation completely erases all recorded data on a selected track of a selected User song, leaving the other tracks intact. Use this operation only when you're sure you want to erase a track and record a new one. To erase the data of an entire song, use the Song Clear operation (page 65).

1 Select the desired song.

Press the [SONG] button, then use the numeric keypad or [+]/[-] buttons to select the desired song (201 - 205).

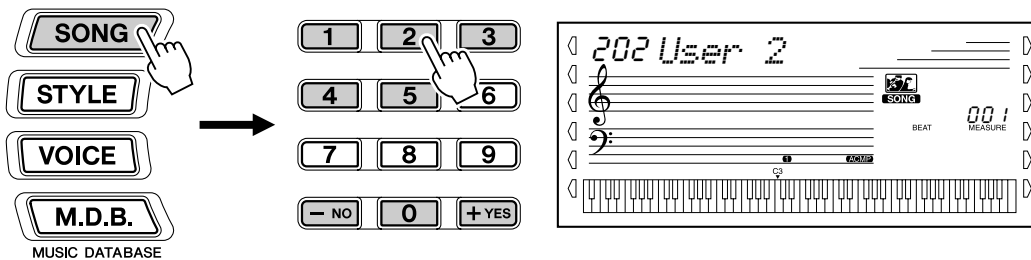

2 Press and hold down the button corresponding to the track to be erased.

Press and hold down the appropriate SONG MEMORY button ([1] - [5], [A]) for at least one second.

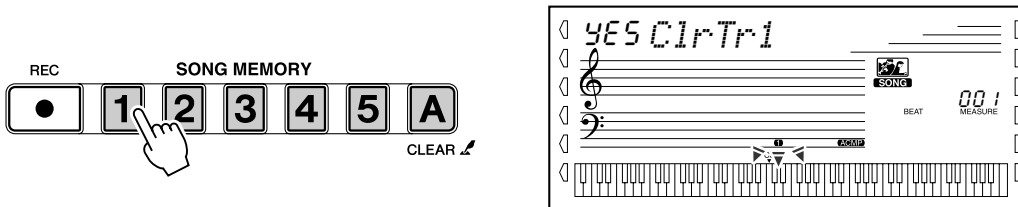

3 Press the [+ / YES] button.

4 At the "Sure?" prompt, press the [+ / YES] button, or press the [- / NO] button to abort.

Pressing the [+ / YES] button executes the Track Clear operation.

Pressing the [- / NO] button aborts.

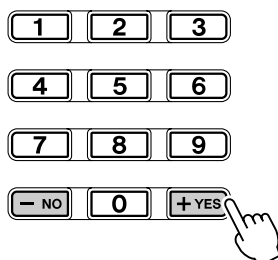



Song Lesson

The Lesson feature provides an exceptionally fun and easy-to-use way to learn how to read music and play the keyboard. There are a total of 100 songs (Songs 001 to 100), specially designed for use with the educational features. Lesson lets you practice the left- and right-hand parts of each song independently, step by step, until you've mastered them and are ready to practice with both hands together. These practices are divided into four Lesson steps, as described below. Lessons 1 - 3 apply to each hand; press the appropriate button, [L] (left) or [R] (right) to select the desired part for practice.

Naturally, you can also use Song data you've loaded from disk with the Lesson features.

■ Lesson 1 — Timing

This lesson step lets you practice just the timing of the notes — any note can be used, as long as you play in rhythm.

■ Lesson 2 — Waiting

In this lesson step, the DGX-500/300 waits for you to play the correct notes before continuing playback of the song.

■ Lesson 3 — Minus One

This lesson step plays back the song with one part muted, letting you play and master the missing part yourself — in rhythm and at the proper tempo.

■ Lesson 4 — Both Hands

Lesson 4 is a “Minus One” practice essentially the same as Lesson 3, except that both the left- and right-hand parts are muted — letting you play and master both hands at the same time.

Using the Lesson Feature

1 Select one of the Lesson songs.

Press the [SONG] button, then use the numeric keypad or [+] / [-] buttons to select the desired song.

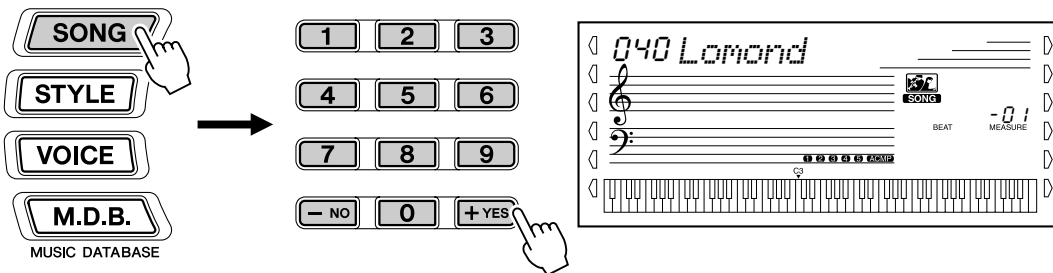

The Lesson songs are divided into several different categories or music genres, with 100 songs available.

Song Lesson

2 Select the part you wish to work on (left or right) and the Lesson step.

If you want to work on the right-hand part, press the [R] button; to work on the left, press the [L] button. Pressing either button repeatedly cycles through the available Lesson steps in order: Lesson 1 → Lesson 2 → Lesson 3 → Off → Lesson 1, etc. The selected Lesson step is indicated in the display.

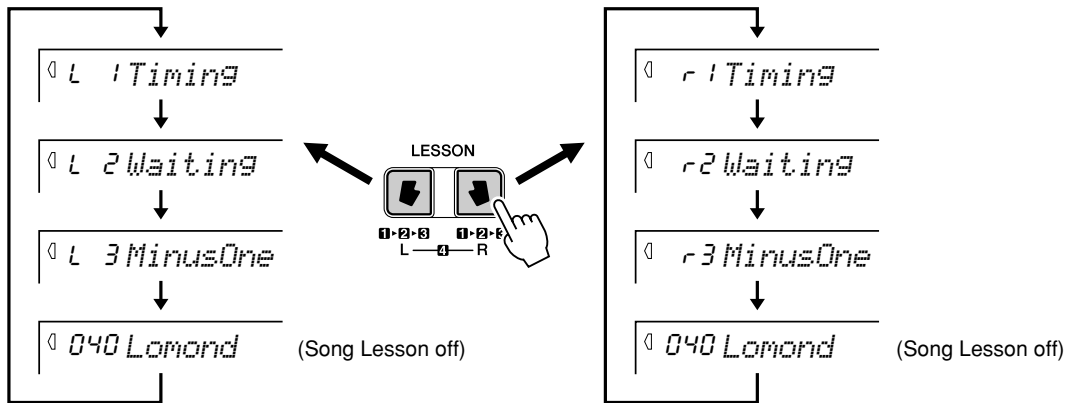

To select Lesson 4, press both [L] and [R] buttons simultaneously.

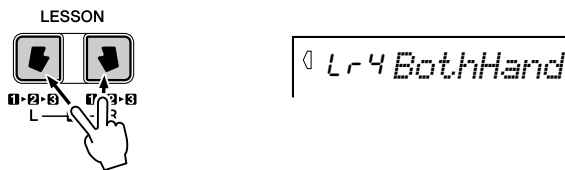

3 Start the Lesson.

The Lesson and song playback start automatically (following a lead-in count) as soon as the Lesson step is selected. When the Lesson is finished, your performance “grade” is shown in the display (if the Grade function is turned on; page 72). After a short pause, the Lesson begins again automatically.

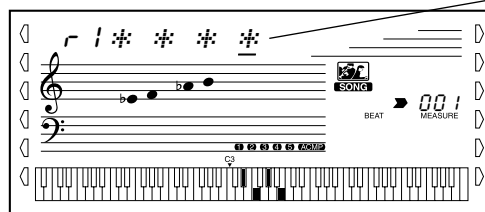
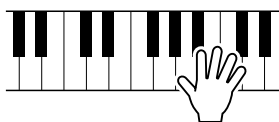

Asterisks appear indicating the timing at which you should play the notes. The line of asterisks represents one full measure. Sixteenth notes are indicated by an alternating asterisk and sharp sign. (for songs having a “free” tempo, no such indications appear.)

4 Press the [START/STOP] button to stop the Lesson.

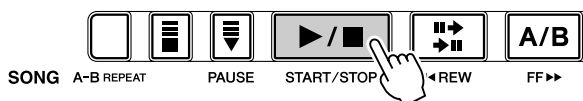

The DGX-500/300 exits from the Lesson feature automatically when the [START/STOP] button is pressed.

Select the Lesson Track

This function allows you to select the track number of a disk song (only SMF format 0). (Refer to the Disk Operations chapter on page 73.)



• If necessary, the Octave setting can be changed for lesson track. (See page 76.)

1 With Song playback stopped, press the Overall right button to select LESSON TRACK L or R.

LESSON TRACK R appears following TRACK L.

2 Set the Track number.

Use the numeric keypad number buttons [0] - [9], or the [+]/[-] buttons to select the Lesson Track number.

Lesson 1 — Timing

This lesson step lets you practice just the timing of the notes — any note can be used, as long as you play in rhythm. Pick a note to play. For the left hand, use a note in the auto accompaniment area or play the appropriate left-hand note; for the right, play a note above F#2. Simply concentrate on playing each note in time with the rhythmic accompaniment.



• The melody note does not sound unless your playing is in time with the rhythm.

1 Select one of the Lesson songs.

2 Select Lesson 1.

Press the [L] or [R] button (repeatedly, if necessary) until Lesson 1 is indicated.

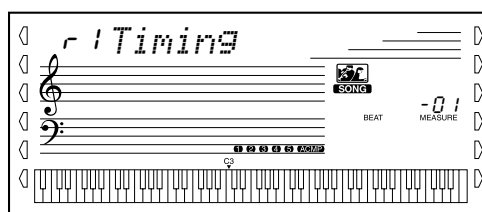
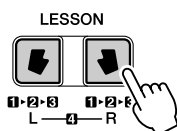

3 Play the appropriate melody or chord with the song.

After the lead-in, the song starts automatically, and the appropriate notes appear in the display. In Lesson 1, simply play one note repeatedly in time with the music.

Regarding chords and the use of the left hand, the DGX-500/300 actually has two different types of songs: 1) songs with normal left-hand chords, and 2) songs in which the left hand plays arpeggios or melodic figures in combination with the right.

In the case of the first type, play the chords with your left hand in the auto accompaniment area of the keyboard.

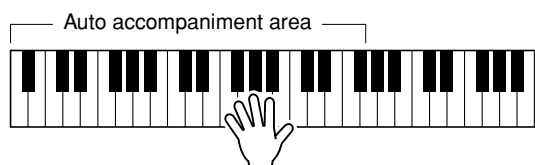

Lesson 2 — Waiting

In this lesson step, the DGX-500/300 waits for you to play the correct notes before continuing playback of the song. This lets you practice reading the music at your own pace. The notes to be played are shown in the display, one after another, as you play them correctly.

1 Select one of the Lesson songs.

2 Select Lesson 2.

Press the [L] or [R] button (repeatedly, if necessary) until Lesson 2 is indicated.

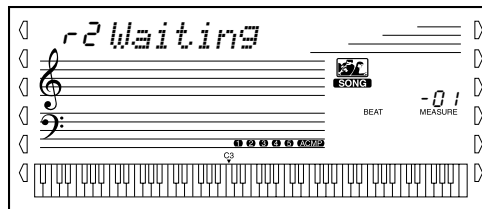
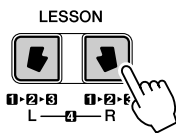

3 Play the appropriate melody or chord with the song.

After the lead-in, the song starts automatically, and the appropriate notes appear in the display. In Lesson 2, play the correct notes at your own pace, until you can master playing them in rhythm.

Lesson 3 — Minus One

This lesson step lets you practice one part of the song in rhythm at the proper tempo. The DGX-500/300 plays back the song accompaniment with one part muted (either the left part or the right)—letting you play and master the missing part yourself. The notes you are to play are shown continuously in the display as the song plays back.

1 Select one of the Lesson songs.

2 Select Lesson 3.

Press the [L] or [R] button (repeatedly, if necessary) until Lesson 3 is indicated.

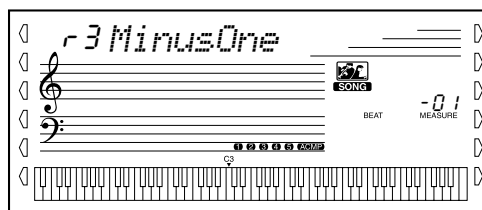
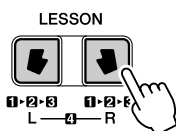

3 Play the appropriate part with the song.

After the lead-in, the song starts automatically, and the appropriate notes appear in the display. In Lesson 3, listen carefully to the un-muted part, and play the muted part yourself.

Lesson 4 — Both Hands

Lesson 4 is a “Minus One” practice essentially the same as Lesson 3, except that both the left- and right-hand parts are muted — letting you play and master both hands at the same time. Go on to this lesson step after you’ve mastered each hand’s part in the previous three lesson steps. Practice both hands in time with the rhythm along with the notation in the display.

1 Select one of the Lesson songs.

2 Select Lesson 4.

Press the [L] and [R] buttons simultaneously, so that Lesson 4 is indicated.

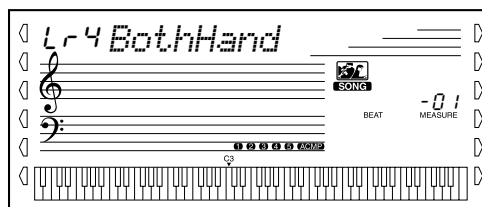
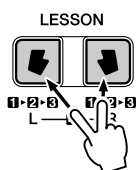

3 Play both the left- and right-hand parts with the song.

After the lead-in, the song starts automatically, and the appropriate notes appear in the display. In Lesson 4, both parts (left and right) are muted, letting you play the entire song by yourself.

Grade

The Lesson feature has a built-in evaluation function that monitors your practicing of the Lesson songs, and just like a real teacher, it tells you how well you did each exercise. Four grades are assigned, depending on your performance: “OK,” “Good,” “Very Good!,” and “Excellent!”

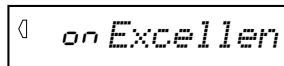

1 Select the Grade function.

Press the right Overall button, repeatedly if necessary, until “GRADE” appears in the display.



• Grade is automatically set to on as the default setting.

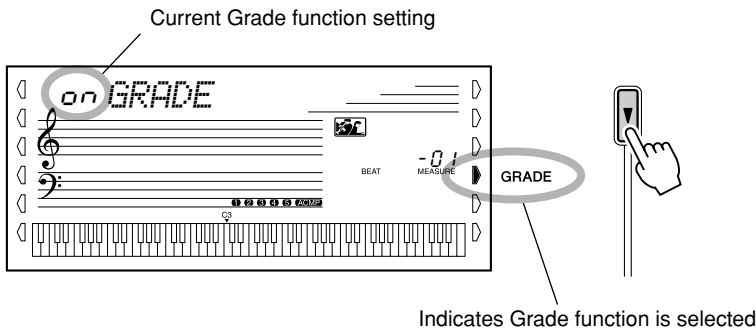

2 Set Grade to on or off as desired.

Use the [+]/[-] buttons to set Grade to on or off.

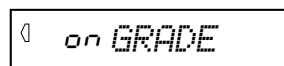
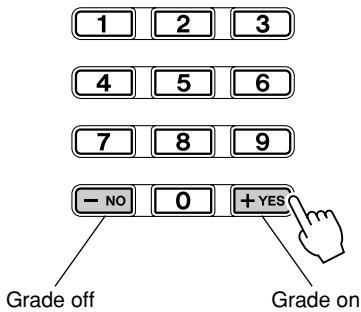



Disk Operations

The DGX-500/300 features a convenient floppy disk drive — built right into the instrument. Let you record and play back your own original User Songs, it allows you to save and load important DGX-500/300 data.

Moreover, since the DGX-500/300 is compatible with a wide variety of disk formats, you can play back song data on commercially available GM (General MIDI), DOC (Disk Orchestra Collection), and Clavinova Disklavier Piano Soft disks.

It also allows you to save and play back Standard MIDI File (SMF) format 0 data.

The DGX-500/300 can also be used with the included disk or commercially available Style File data, allowing you to load additional styles (auto accompaniment patterns) to the instrument. Style File data is loaded individually as style number 136, and can be played just like the preset styles. Once loaded, the Style File data can then be saved in combination with User songs.

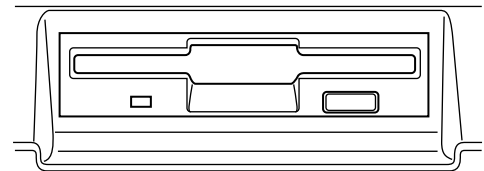
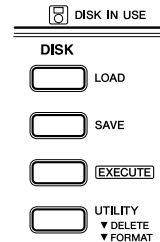

Data that Can be Saved or Loaded with the DGX-500/300

Data type	Extension	Save	Load
User Songs	.USR	○	○
Style File	.STY	-	○

Using Commercially Available Music Data (sold separately)

The DGX-500/300 is compatible with music disks (floppy disks) that bear the following marks:



You can playback song files collected on these disks using the voices defined in the GM standard. (See page 75)
“GM System Level 1” is an addition to the MIDI standard which ensures that any GM-compatible music data can be accurately played by any GM-compatible tone generator, regardless of manufacturer. The GM mark is affixed to all software and hardware products that support GM System Level 1. The DGX-500/300 supports GM System Level 1.



As its name implies, “XGlite” is a simplified version of Yamaha’s high-quality XG tone generation format. Naturally, you can play back any XG song data using an XGlite tone generator. However, keep in mind that some songs may play back differently compared to the original data, due to the reduced set of control parameters and effects.



You can playback song files collected on these disks using the voices defined in Yamaha’s DOC format. (See page 75)
The DOC voice allocation format provides data playback compatibility with a wide range of Yamaha instruments and MIDI devices, including the Clavinova series.



You can load and play with the style files collected on these disks. (See page 79)
The Style File Format — SFF — is Yamaha’s original style file format which uses a unique conversion system to provide high-quality automatic accompaniment based on a wide range of chord types. The DGX-500/300 uses the SFF data internally, reading from optional SFF style disks.

IMPORTANT

- While any of the disk-related displays are shown (called up by pressing the LOAD, SAVE, or UTILITY buttons), no panel operations can be executed (except for disk operations), and playing the keyboard does not produce any sound.

NOTE

- User Songs and Disk Style data (style number 136) are saved and loaded as a single file on the DGX-500/300.
- To ensure proper data storage, use only disks that have been formatted on the DGX-500/300 (page 81).
- The three letters following the file name (after the period) are referred to as a file “extension.” The extension indicates the type of file.

Using the Floppy Disk Drive (FDD) and Floppy Disk

Be sure to handle floppy disks and treat the disk drive with care. Follow the important precautions below.

Compatible Disk Type

3.5" 2DD and 2HD type floppy disks can be used.

Inserting/Ejecting Floppy Disks

- To insert a floppy disk into the disk drive:
 - Hold the disk so that the label of the disk is facing upward and the sliding shutter is facing forward, towards the disk slot. Carefully insert the disk into the slot, slowly pushing it all the way in until it clicks into place and the eject button pops out.

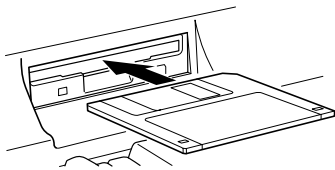

NOTE

- When the DGX-500/300 is turned on, the LED below the floppy disk slot will be lit indicating that the Disk Drive is ready to use.

- To eject a floppy disk:
 - Before ejecting the disk, be sure to confirm that the FDD is stopped. Press the eject button slowly as far as it will go; the disk will automatically pop out. When the disk is fully ejected, carefully remove it by hand.

This lamp lights during disk read/write operations, such as when a disk has been inserted, during recording, playback, formatting, etc.

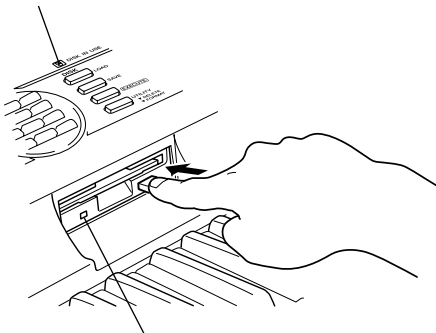

This lamp is always on when the power is on, regardless of Disk operation.

- If the eject button is pressed too quickly, or if it is not pressed in as far as it will go, the disk may not eject properly. The eject button may become stuck in a half-pressed position with the disk extending from the drive slot by only a few millimeters. If this happens, do not attempt to pull out the partially ejected disk, since using force in this situation can damage the disk drive mechanism or the floppy disk. To remove a partially ejected disk, try pressing the eject button once again, or push the disk back into the slot and then repeat the eject procedure.

- Never attempt to remove the disk or turn the power off during recording, reading and playing back (when the DISK IN USE lamp is lit). Doing so can damage the disk and possibly the disk drive.
- Be sure to remove the floppy disk from the disk drive before turning off the power. A floppy disk left in the drive for extended periods can easily pick up dust and dirt that can cause data read and write errors.

Cleaning the Disk Drive Read/Write Head

- Clean the read/write head regularly. This instrument employs a precision magnetic read/write head which, after an extended period of use, will pick up a layer of magnetic particles from the disks used that will eventually cause read and write errors.
- To maintain the disk drive in optimum working order Yamaha recommends that you use a commercially-available dry-type head cleaning disk to clean the head about once a month. Ask your Yamaha dealer about the availability of proper head-cleaning disks.
- Never insert anything but floppy disks into the disk drive. Other objects may cause damage to the disk drive or floppy disks.

About the Floppy Disks

- To handle floppy disks with care:
 - Do not place heavy objects on a disk or bend or apply pressure to the disk in any way. Always keep floppy disks in their protective cases when they are not in use.
 - Do not expose the disk to direct sunlight, extremely high or low temperatures, or excessive humidity, dust or liquids.
 - Do not open the sliding shutter and touch the exposed surface of the floppy disk inside.
 - Do not expose the disk to magnetic fields, such as those produced by televisions, speakers, motors, etc., since magnetic fields can partially or completely erase data on the disk, rendering it unreadable.
 - Never use a floppy disk with a deformed shutter or housing.
 - Do not attach anything other than the provided labels to a floppy disk. Also make sure that labels are attached in the proper location.
- To protect your data (write-protect tab):
 - To prevent accidental erasure of important data, slide the disk's write-protect tab to the "protect" position (tab open).

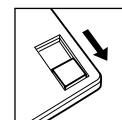
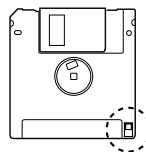

Write protect tab ON
(locked or write protected)

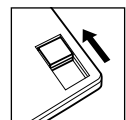

Write protect tab OFF
(unlocked or write enabled)

Disk Song Playback

This function allows you to play back song data on commercially available GM (General MIDI), Yamaha DOC (Disk Orchestra Collection), or Clavinova Disklavier Piano Soft disks. It also allows you to play back Standard MIDI File (SMF) format 0 data.

1 Insert the disk into the disk drive.

Once the disk is inserted, the DGX-500/300 will automatically switch to the Song mode.

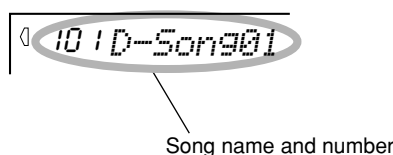
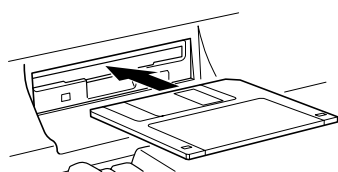

2 Select the desired song number.

Use the numeric keypad or the [+]/[-] buttons. The disk song numbers are from 101 to 199.

3 Start the selected song.

Press the [START/STOP] button.

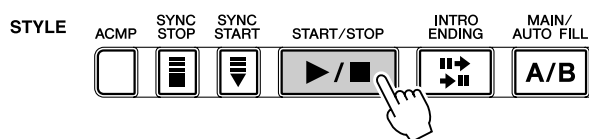

NOTE

- The tempo setting of some commercially available disk songs is fixed. These songs are called "free-tempo software." When playing back free-tempo song data on the DGX-500/300, the measure display shows "F t" and the beat display does not flash. Also, the measure number in the display does not match the actual measure number of playback, and only gives you an indication of how much of the song has played back.

Some of song files on the included sample disk are also free-tempo software.

4 If you want to change to another song, repeat step 2 above.

5 Stop the song.

Press the [START/STOP] button.

For details, see "Selecting and Playing a Song," page 57.

Change the Track Octave Setting for a Disk Song Track

When a disk song is playing and the note data exceeds the limit of A-1 – C7 (DGX-500), E0 – G6 (DGX-300), an “OVER” indication flashes and ◀ or ▶ appears in the display. If this happens, you can adjust the track octave setting of the relevant track up or down to compensate.



1 Select the Track Octave function.

Press the right Overall button, until “OCTAVE” appears in the display

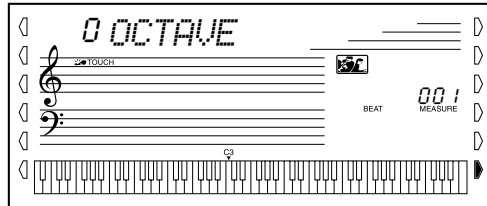

TRACK OCTAVE

2 Change the Track Octave setting.

To set a positive octave value, press the number button, 0, 1, or 2.

To set a negative value, simultaneously hold down the [-] button and press the appropriate number button, 1 or 2.

NOTE

- The Track Octave setting can only be changed when the Song is stopped.

Save

You can save User songs (song #201 - #205) to floppy disks.

1 Insert a formatted floppy disk.

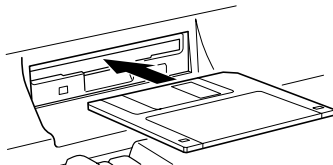

2 Press the [SAVE] button.

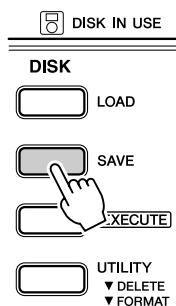

Indicates new file name

NOTE

- If the [SAVE] button is pressed when there is no floppy disk inserted into the disk drive, a “No disk” message appears at the top of the display, and all disk operations will be disabled.
- When the floppy disk’s write-protect tab is set to ON (page 74) or the disk is a purposely “copy-protected” disk, a “Protect” message appears, indicating that the Save function is not possible.

If you wish to overwrite the data already saved to an existing file, use the [+]/[-] buttons to select the file you want to overwrite.

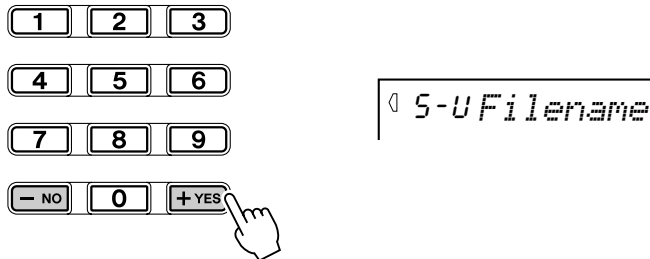

To exit from the Save screen, press the [UTILITY] button repeatedly.

3 If necessary change the file name.

The DGX-500/300 automatically creates a file name (for example “UF_00nnn”) for the file you are about to save. If you want to enter a more descriptive name for easier file identification (and this is recommended), this can be done directly from the keyboard.

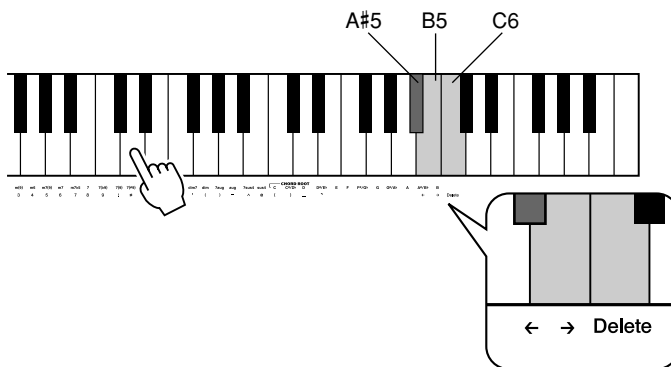

A file name can consist of up to 8 characters. Each key on the keyboard enters a different character, printed directly under the key (you cannot write over the file extension following the period at the end of the file name). The A#5 and B5 keys move the cursor backward and forward within the file name. Use these keys to place the cursor where you want to enter or change a character. The Delete key (C6) deletes the character at the cursor position.

To exit from the Save screen, press the [UTILITY] button repeatedly.

4 Press the [EXECUTE] button.

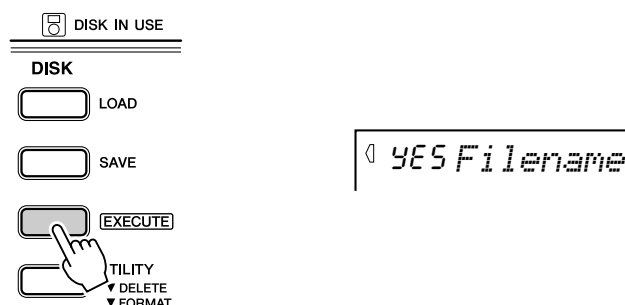

To exit from the Save screen, press the [UTILITY] button repeatedly.

NOTE

- Even if you chose a file where data is already saved because you want to overwrite the data, renaming the file will cause the new data to be saved in a different file, and the old data won't be overwritten.

NOTE

- If you have selected a file to which data has already been saved, “yES Over Wr?” will appear on the top line of the display.

5 Execute the Save operation.

Press the [+] button (“YES”), and the Save operation will start. Once started, the operation cannot be canceled.

As the file is saving, “Saving” will appear on the top line of the display.

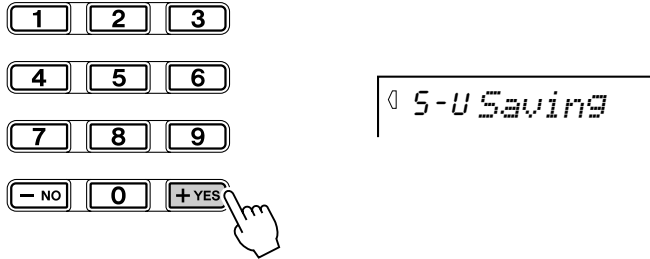

To avoid saving the file, press the [-] button (“NO”) instead of the [+] button (“YES”).

To exit from the Save screen, press the [UTILITY] button repeatedly.

When the operation is completed, the following display briefly appears.

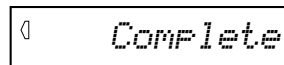

NOTE

- If there isn't enough space on the disk, a "DiskFull" message appears, and you will not be able to save any data. You can delete unneeded files on the disk (page 80), or replace the disk with a new one and repeat the save operation.
- If a write error occurs during a save operation, an "Error" message appears. If the error reoccurs after repeating the save operation, there could be something wrong with the disk. Insert a different disk in the drive and retry the save operation.

CAUTION

- While the file is being saved (the DISK IN USE lamp is lit), never eject the floppy disk or turn the power off.

Saving files in SMF Format 0

The DGX-500/300 can also save song data in SMF (Standard MIDI File) Format 0. To do this:

2-1 In step #2 of the above Save operation, after pressing the [SAVE] button, press the [SAVE] button again to call up the SMF Save mode.

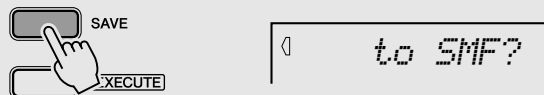

2-2 Press the [EXECUTE] button.

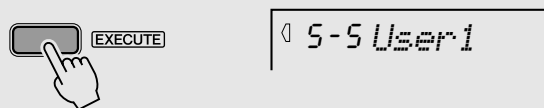

2-3 Select a song for saving, if necessary, using the [+]/[-] buttons.

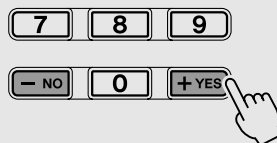

2-4 Press the [EXECUTE] button.



Continue with step #3 of the Save operation above.

Load

Once you've saved your User data onto a floppy disk, you can reload that data back to the DGX-500/300. You can also load style data from the included disk or commercially available Yamaha Style File disks.

1 Insert the floppy disk into the disk drive.

2 Press the [LOAD] button.

Press the [LOAD] button again to exit from the LOAD screen.

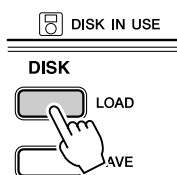

This case is user file. Style file indicates "L-S".

NOTE

- If the [LOAD] button is pressed when there is no floppy disk inserted into the disk drive, a "No disk" message appears at the top of the display, and all disk operations will be disabled.

3 Select the file to load.

Use the [+]/[-] buttons.

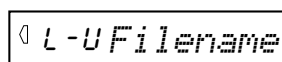
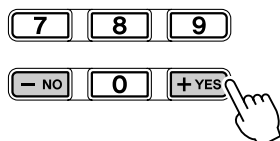

NOTE

- If the disk contains no file, the display shows "No file" indicating that the Load function is not possible.

4 Press the [EXECUTE] button.

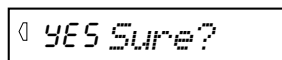

NOTE

- When data is loaded from a floppy disk to the DGX-500/300, the data already in the memory of the DGX-500/300 will be replaced by the data on the disk. Save important data into a disk file before doing the operation.

5 Execute the Load operation.

Press the [+] button ("YES"), and the Load operation will start. Once started, the operation cannot be canceled.

As the file is loading, "Loading" will appear on the top line of the display.

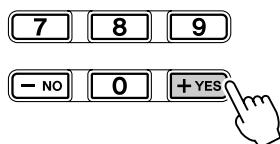

CAUTION

- While the file is loading (the DISK IN USE lamp is lit), never eject the floppy disk or turn the power off.

When the operation is completed, the following display briefly appears.



If you do not intend to load the file, press the [-] button ("NO") instead of the [+] button ("YES").

To exit from the LOAD screen, press the [LOAD] button.

Utility – Delete

This function allows you to delete individual files of User data you've saved to floppy disk.

1 Insert the floppy disk into the disk drive.

2 Press the [UTILITY] button.

The filename will appear at the top of the display.

To exit from the UTILITY screen, press the [UTILITY] button twice.

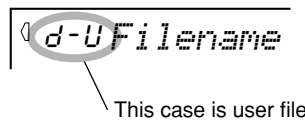
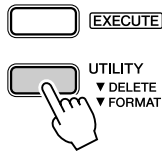

3 Select the file to be deleted.

Use the [+]/[-] buttons.

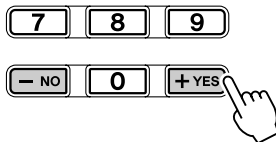

4 Press the [EXECUTE] button.



5 Execute the delete operation.

Press the [+] button ("YES"), and the Delete operation will start. Once started, the operation cannot be canceled.

As the file is deleting, "Deleting" will appear on the top line of the display.

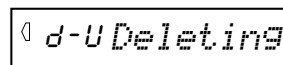
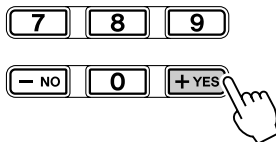

When the operation is completed, the following display briefly appears.

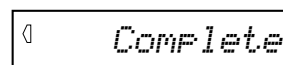

If you do not intend to delete the file, press the [-] button ("NO") instead of the [+] button ("YES").

To exit from the UTILITY screen, press the [UTILITY] button twice.

NOTE

- If the [UTILITY] button is pressed when there is no floppy disk inserted into the disk drive, a "No disk" message appears at the top of the display, and all disk operations will be disabled.
- When the floppy disk's write-protect tab is set to ON (see page 74) or the disk is a purposely "copy-protected" disk, a "Protect" message appears, indicating that the Utility function is not possible.
- SMF files are indicated by "d-s".

IMPORTANT

- Only files that were created on the DGX-500/300 and were saved as files (User song, etc.) can be deleted. When there are no files on disk that the DGX-500/300 can delete, the FORMAT display appears instead of DELETE, when the [UTILITY] button is pressed.

CAUTION

- While the file is being deleted (the DISK IN USE lamp is lit), never eject the floppy disk or turn the power off.

Utility – Formatting an Unformatted Disk

1 Insert the unformatted floppy disk into the disk drive.

A “Format?” message will appear at the top of the display.
Press the [UTILITY] button to exit from the FORMAT screen.

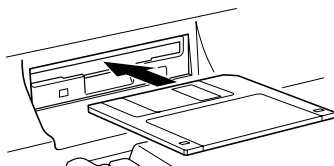

```
◁ CUE Format?
```

NOTE

- If you insert an unformatted disk with the write protect tab in the ON position into the drive, a “Protect” message appears. Eject the disk, move the protect tab to the OFF position, and reinsert it in the drive.

2 Press the [EXECUTE] button.



```
◁ YES Sure?
```

CAUTION

- If a disk that cannot be read by the DGX-500/300 is inserted into the disk drive, it will be treated the same as an unformatted floppy disk. Take care not to erase important data by accidentally formatting a disk.

3 Execute the Format operation.

Press the [+] button (“YES”), and the Format operation will start. Once started, the operation cannot be canceled.
During formatting, “Formatin” will appear at the top of the display.

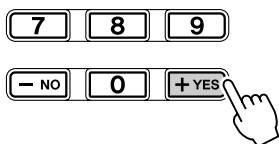

```
◁ 072 Formatin
```

CAUTION

- While formatting is in progress (the DISK IN USE lamp is lit), never eject the disk or turn the power off.

When the operation is completed, the following display briefly appears.

```
◁ Complete
```

If you do not intend to format the disk, press the [-] button (“NO”) instead of the [+] button (“YES”).

To exit from the UTILITY screen, press the [UTILITY] button.

Utility – Formatting a Previously Formatted Disk

This function is useful for quickly deleting unnecessary files from an already formatted disk. Be careful when using this operation, since it automatically deletes all data on the disk.

1 Insert the floppy disk into the disk drive.

2 Press the [UTILITY] button.

This calls up the Delete operation (page 80). The filename will appear at the top of the display. When there are no files on disk that the DGX-500/300 can delete, the FORMAT display appears instead of DELETE, when the [UTILITY] button is pressed. In this situation, step #2 is unnecessary.

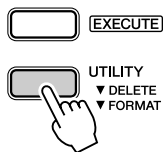

NOTE

- If the [UTILITY] button is pressed when there is no floppy disk inserted into the disk drive, a “No disk” message appears at the top of the display, and all disk operations will be disabled.

3 Press the [UTILITY] button again.

This calls up the Format operation.

“Format?” will appear at the top of the display.

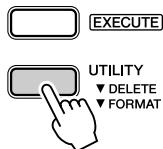

NOTE

- When the floppy disk’s write-protect tab is set to ON (see page 74) or the disk is a purposely “copy-protected” disk, a “Protect” message appears, indicating that the Utility function is not possible.

4 Press the [EXECUTE] button.

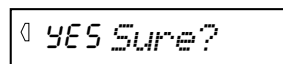

5 Execute the Format operation.

Press the [+] button (“YES”), and the Format operation will start. Once started, the operation cannot be canceled. During formatting, “Formatin” will appear at the top of the display.

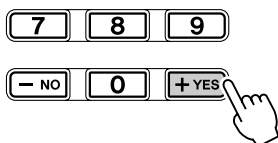

CAUTION

- While formatting is in progress (the DISK IN USE lamp is lit), never eject the disk or turn the power off.
- If data is already saved on the disk, be careful not to format it. If you format the disk, all the previously recorded data will be deleted.

When the operation is completed, the following display briefly appears.

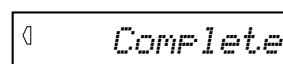

If you do not intend to format the disk, press the [-] button (“NO”) instead of the [+] button (“YES”). To exit from the operation, press the UTILITY button.



MIDI Functions

The DGX-500/300 is MIDI-compatible, featuring MIDI IN and MIDI OUT terminals and providing a variety of MIDI-related controls. By using the MIDI functions you can expand your musical possibilities. This section explains what MIDI is, and what it can do, as well as how you can use MIDI on your DGX-500/300.

What Is MIDI?

No doubt you have heard the terms “acoustic instrument” and “digital instrument.” In the world today, these are the two main categories of instruments. Let’s consider an acoustic piano and a classical guitar as representative acoustic instruments. They are easy to understand. With the piano, you strike a key, and a hammer inside hits some strings and plays a note. With the guitar, you directly pluck a string and the note sounds. But how does a digital instrument go about playing a note?

Acoustic guitar note production

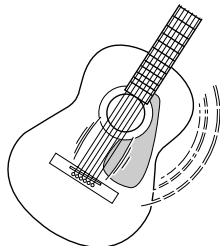

Pluck a string and the body resonates the sound.

Digital instrument note production

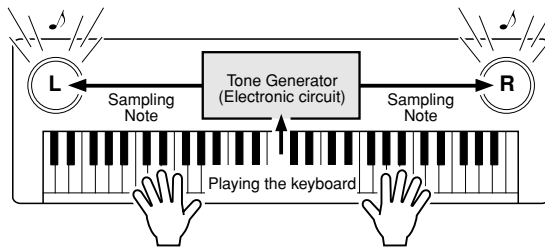

Based on playing information from the keyboard, a sampling note stored in the tone generator is played through the speakers.

As shown in the illustration above, in an electronic instrument the sampling note (previously recorded note) stored in the tone generator section (electronic circuit) is played based on information received from the keyboard. So then what is the information from the keyboard that becomes the basis for note production?

For example, let’s say you play a “C” quarter note using the grand piano sound on the DGX-500/300 keyboard. Unlike an acoustic instrument that puts out a resonated note, the electronic instrument puts out information from the keyboard such as “with what voice,” “with which key,” “about how strong,” “when was it pressed,” and “when was it released.” Then each piece of information is changed into a number value and sent to the tone generator. Using these numbers as a basis, the tone generator plays the stored sampling note.

● Example of Keyboard Information

Voice number (with what voice)	01 (Live! Grand)
Note number (with which key)	60 (C3)
Note on (when was it pressed) and note off (when was it released)	Timing expressed numerically (quarter note)
Velocity (about how strong)	20 (strong)

GM System Level 1

“GM System Level 1” is an addition to the MIDI standard which ensures that any GM-compatible music data can be accurately played by any GM-compatible tone generator, regardless of manufacturer. The GM mark is affixed to all software and hardware products that support GM System Level 1. The DGX-500/300 supports GM System Level 1.



MIDI Functions

MIDI is an acronym that stands for Musical Instrument Digital Interface, which allows electronic musical instruments to communicate with each other, by sending and receiving compatible Note, Control Change, Program Change and various other types of MIDI data, or messages.

The DGX-500/300 can control a MIDI device by transmitting note related data and various types of controller data. The DGX-500/300 can be controlled by the incoming MIDI messages which automatically determine tone generator mode, select MIDI channels, voices and effects, change parameter values and of course play the voices specified for the various parts.

MIDI messages can be divided into two groups: Channel messages and System messages. Below is an explanation of the various types of MIDI messages which the DGX-500/300 can receive/transmit.

● Channel Messages

The DGX-500/300 is an electronic instrument that can handle 16 channels. This is usually expressed as “it can play 16 instruments at the same time.” Channel messages transmit information such as Note ON/OFF, Program Change, for each of the 16 channels.

Message Name	DGX-500/300 Operation/Panel Setting
Note ON/OFF	Messages which are generated when the keyboard is played. Each message includes a specific note number which corresponds to the key which is pressed, plus a velocity value based on how hard the key is struck.
Program Change	Voice number (along with corresponding bank select MSB/LSB settings, if necessary).
Control Change	Messages that are used to change some aspect of the sound (modulation, volume, pan, etc.).

● System Messages

This is data that is used in common by the entire MIDI system. System messages include messages like Exclusive Messages that transmit data unique to each instrument manufacturer and Realtime Messages that control the MIDI device.

Message Name	DGX-500/300 Operation/Panel Setting
Exclusive Message	Reverb/chorus/DSP settings, etc.
Realtime Messages	Start/stop operation

The messages transmitted/received by the DGX-500/300 are shown in the MIDI Implementation Chart on page 102.

MIDI Terminals

In order to exchange MIDI data between multiple devices, each device must be connected by a cable. The MIDI terminals of the DGX-500/300 are located on the rear panel.

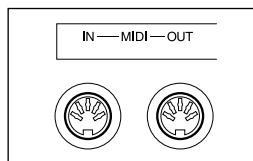

MIDI IN	Receives MIDI data from another MIDI device.
MIDI OUT	Transmits the DGX-500/300's keyboard information as MIDI data to another MIDI device.

NOTE

- Special MIDI cables (sold separately) must be used for connecting to MIDI devices. They can be bought at music stores, etc.
- Never use MIDI cables longer than about 15 meters. Cables longer than this can pick up noise which can cause data errors.

Connecting to a Personal Computer

By connecting your DGX-500/300's MIDI terminals to a personal computer, you can have access to a wide variety of music software.

When using a MIDI interface device installed in the personal computer, connect the MIDI terminals of the personal computer and the DGX-500/300.

Use only special MIDI cables when connecting MIDI devices.

- **Connect the MIDI terminals of the DGX-500/300 to the MIDI terminals of the personal computer.**

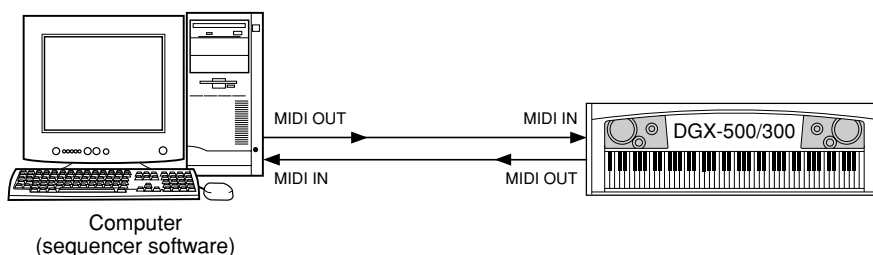

- **When using a MIDI interface with a Macintosh series computer, connect the RS-422 terminal of the computer (modem or printer terminal) to the MIDI interface, as shown in the diagram below.**

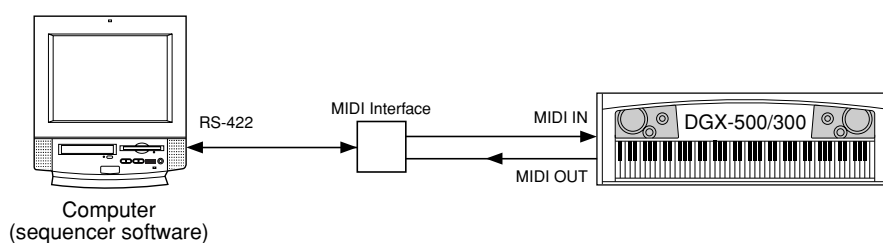

NOTE

• When using a Macintosh series computer, set the MIDI interface clock setting in the application software to match the setting of the MIDI interface you are using. For details, refer to the owner's manual for the software you are using.

NOTE

Viewing the Notation for MIDI Channel 1

- The DGX-500/300 has a special function that lets you view the notes of the MIDI data (channel 1 only) on the display.

- **When connecting to a computer with a USB interface, use the Yamaha UX16 USB/MIDI Interface. Connect the UX16 and the computer with a standard USB cable, then make the proper MIDI connections between the DGX-500/300 and the UX16.**

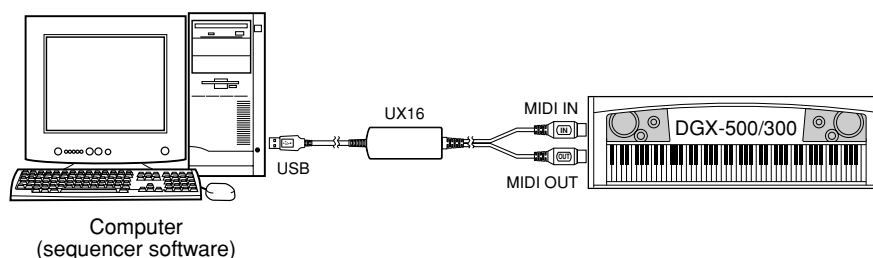

Local Control

This function lets you enable or disable keyboard control over the DGX-500/300's voices. This would come in handy, for example, when recording notes to MIDI sequencer. If you are using the sequencer to play back the voices of the DGX-500/300, you would want to set this to "off" — in order to avoid getting "double" notes, both from the keyboard and from the sequencer. Normally, when playing the DGX-500/300 by itself, this should be set to "on."

1 Select the MIDI operations.

Press the left Overall button, repeatedly if necessary, until MIDI is selected.

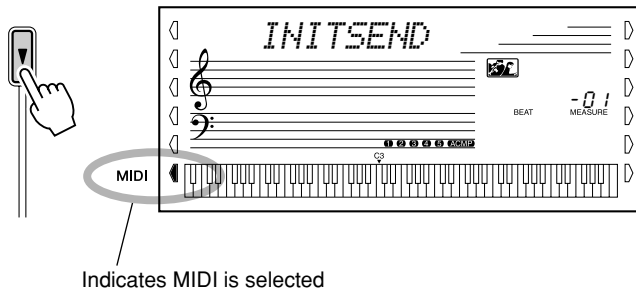

2 Select the Local Control parameter.

Press "1" on the numeric keypad to select operation #1, Local Control. If the LOCAL display appears instead of INITSEND in step #1 above, step #2 is unnecessary.

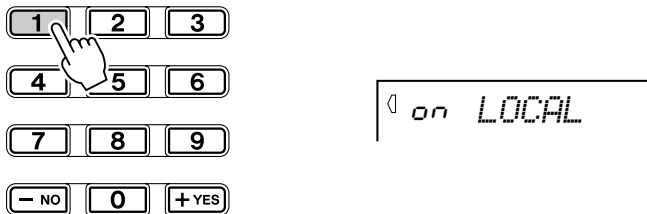

3 Press the [+]/[-] buttons.

Set Local Control to on or off, as desired.

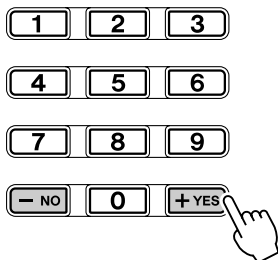

CAUTION

- No sound is output from the DGX-500/300 when Local ON/OFF is set to OFF.

Using Initial Setup Send with a Sequencer

The most common use for the Initial Setup Send function is in recording a song on a sequencer that is intended for playback with the DGX-500/300. Essentially, this takes a “snapshot” of the DGX-500/300 settings and sends that data to the sequencer. By recording this “snapshot” at the start of the song (before any actual performance data), you can instantly restore the necessary settings on the DGX-500/300. Provided there is a pause in the song, you could also do this in the middle of a song — for example, completely changing the DGX-500/300 settings for the next section of the song.

■ Sending Initial Setup Data

1 First, set up the sequencer for recording.

The actual procedure may differ depending on your particular equipment and software.

Ideally, you should leave two or more measures of silence (no performance data) before the song begins. The Initial Setup data should then be recorded to this space in the song.

2 Select the MIDI operations.

Press the left Overall button, repeatedly if necessary, until MIDI is selected.

3 Select the Initial Setup Send operation.

Press “2” on the numeric keypad to select operation #2, Initial Setup Send. If the INITSEND display appears instead of LOCAL in step #2 above, step #3 is unnecessary.

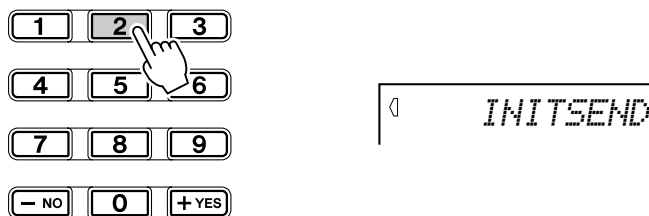

4 Press the [START/STOP] button.

Start the Initial Setup Send operation.

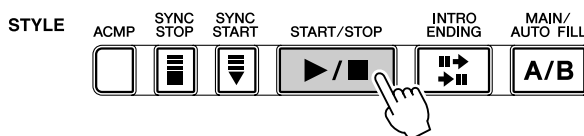

5 Start recording on the sequencer, then send the Initial Setup data.

Start recording on the sequencer in the normal way, then — with as little delay as possible — press the [+] button to actually start transmitting the data.

An “End” message briefly appears in the display when the operation is complete.



6 Stop recording on the sequencer.

Stop recording on the sequencer in the normal way. Make sure that any subsequently recorded performance data is recorded at least one measure following the Initial Setup data.



- When the Initial Setup Send operation is completed, the DGX-500/300 automatically returns to the previous panel condition.

External Clock

This determines whether the style and song playback functions are controlled by the DGX-500/300’s internal clock (off) or by MIDI clock data from an external sequencer or computer (on).

This should be set to on when you want to have style or song playback follow the external device (such as a rhythm machine or a sequencer). The default setting is off.

1 Press the [TEMPO] button.

2 Set the instrument to External Clock.

Press and hold the [+] button until the value “280” is indicated, then press the [+] button once more to select “ECL” (External Clock) in the display.

To return to the Internal Clock setting, simply select a Tempo value from 32 to 280.



- If External Clock is set to ON, style or song playback will not start unless external clock are received.

MIDI LSB receive cancel.

Set to receive or not receive the LSB data of BANK SELECT.
Press and hold the lowest key and turning on the power.

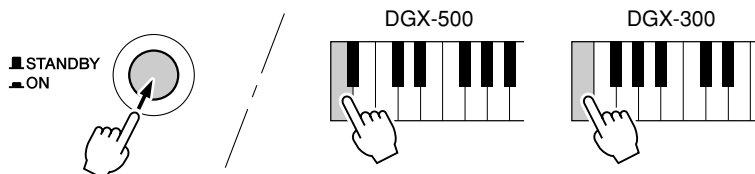

Turning on the power again normally, “MIDI LSB receive cancel” return to normal.



Troubleshooting

Problem	Possible Cause and Solution
When the DGX-500/300 is turned on or off, a popping sound is temporarily produced.	This is normal and indicates that the DGX-500/300 is receiving electrical power.
When using a mobile phone, noise is produced.	Using a mobile phone in close proximity to the DGX-500/300 may produce interference. To prevent this, turn off the mobile phone or use it further away from the DGX-500/300.
There is no sound even when the keyboard is played or when a song is being played back.	Check that nothing is connected to the PHONES/OUTPUT jack on the rear panel. When a set of headphones is plugged into this jack, no sound is output.
	Check the Local Control on/off. (See page 86.)
Playing keys in the right hand section of the keyboard does not produce any sound.	When using the Dictionary function (page 50), the keys in the right hand section are used only for entering the chord root and type.
The sound of the voices or rhythms seems unusual or strange.	The battery power is too low. Replace the batteries. (See page 10.)
The song or style does not start playback.	Check the External Clock. (See page 88.)
The auto accompaniment doesn't turn on, even when pressing the [ACMP] button.	Make sure the Style mode is active before using the auto accompaniment. Press the [STYLE] button to enable style operations.
The accompaniment does not sound properly.	Make sure that the Accompaniment Volume (page 46) is set to an appropriate level. Make sure that the Split Point (page 49) is set to an appropriate value.
When playing back one of the Pianist styles (#124 - #135), the rhythm cannot be heard.	This is normal. The Pianist styles have no drums or bass — only piano accompaniment. The accompaniment of the style can only be heard when accompaniment is set to ON and keys are played in the auto accompaniment area of the keyboard.
Not all of the voices seem to sound, or the sound seems to be cut off.	The DGX-500/300 is polyphonic up to a maximum of 32 notes. If the Dual voice or Split voice is being used and a style or song is playing back at the same time, some notes/sounds may be omitted (or "stolen") from the accompaniment or song.
A strange "flanging" or "doubling" sound occurs when using the DGX-500/300 with a sequencer. (This may also sound like a "dual" layered sound of two voices, even when Dual is turned off.)	When using the accompaniment with a sequencer, set MIDI Echo (or the relevant control) to "off." (Refer to the owner's manual of your particular device and/or software for details.)
The footswitch (for sustain) seems to produce the opposite effect. For example, pressing the footswitch cuts off the sound and releasing it sustains the sounds.	The polarity of the footswitch is reversed. Make sure that the footswitch plug is properly connected to the FOOT SWITCH jack before turning on the power. Do not press the pedal while turning the power on.
The sound of the voice changes from note to note.	The AWM tone generation method uses multiple recordings (samples) of an instrument across the range of the keyboard; thus, the actual sound of the voice may be slightly different from note to note.



Data Backup & Initialization

■ Data Backup

Except for the data listed below, all DGX-500/300 panel settings are reset to their initial settings whenever the power is turned on. The data listed below are backed up — i.e. retained in memory — as long as an AC adaptor is connected or a set of batteries is installed.

- User Song Data
- Song Volume
- Registration Memory Data
- Registration Memory Bank Number
- Metronome Volume
- Touch On/Off
- Tuning
- Grade On/Off

■ Data Initialization

All data can be initialized and restored to the factory preset condition by turning on the power while holding the highest (rightmost) white key on the keyboard. “CLr Backup” will appear briefly on the display.

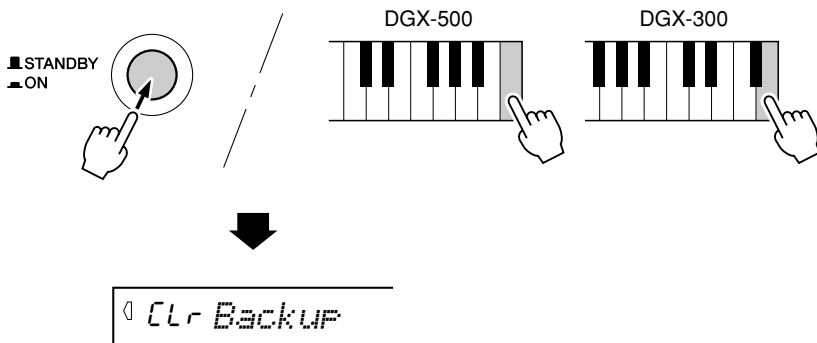

CAUTION

- All Registration Memory and User song data, plus the other settings listed above, will be erased and/or changed when the data initialization procedure is carried out.
- Carrying out the data initialization procedure will usually restore normal operation if the DGX-500/300 freezes or begins to act erratically for any reason.



Voice List

■ Maximum Polyphony

The DGX-500/300 has 32-note maximum polyphony. This means that it can play a maximum of up to 32 notes at once, regardless of what functions are used. Auto Accompaniment uses a number of the available notes, so when Auto Accompaniment is used the total number of available notes for playing on the keyboard is correspondingly reduced. The same applies to the Split Voice and Song functions.

NOTE

- The Voice List includes MIDI program change numbers for each voice. Use these program change numbers when playing the DGX-500/300 via MIDI from an external device.
- Some voices may sound continuously or have a long decay after the notes have been released while the sustain pedal (foot-switch) is held.

● Panel Voice List

Voice No.	Bank Select		MIDI Program Change#	Voice Name
	MSB	LSB		
PIANO				
001	000	113	000	Live! Grand
002	000	112	000	Grand Piano
003	000	112	001	Bright Piano
004	000	112	003	Honky-tonk Piano
005	000	112	002	MIDI Grand Piano
006	000	113	002	CP 80
007	000	112	006	Harpsichord
E. PIANO				
008	000	114	004	Galaxy EP
009	000	112	004	Funky Electric Piano
010	000	112	005	DX Modern Elec. Piano
011	000	113	005	Hyper Tines
012	000	114	005	Venus Electric Piano
013	000	112	007	Clavi
ORGAN				
014	000	118	018	Cool! Organ
015	000	112	016	Jazz Organ 1
016	000	113	016	Jazz Organ 2
017	000	112	017	Click Organ
018	000	116	016	Bright Organ
019	000	112	018	Rock Organ
020	000	114	018	Purple Organ
021	000	118	016	16'+2' Organ
022	000	119	016	16'+4' Organ
023	000	114	016	Theater Organ
024	000	112	019	Church Organ
025	000	113	019	Chapel Organ
026	000	112	020	Reed Organ
ACCORDION				
027	000	113	021	Traditional Accordion
028	000	112	021	Musette Accordion
029	000	113	023	Bandoneon
030	000	112	022	Harmonica
GUITAR				
031	000	112	024	Classical Guitar
032	000	112	025	Folk Guitar
033	000	113	025	12Strings Guitar
034	000	112	026	Jazz Guitar
035	000	113	026	Octave Guitar
036	000	112	027	Clean Guitar
037	000	117	027	60's Clean Guitar
038	000	112	028	Muted Guitar
039	000	112	029	Overdriven Guitar
040	000	112	030	Distortion Guitar
BASS				
041	000	112	032	Acoustic Bass
042	000	112	033	Finger Bass

Voice No.	Bank Select		MIDI Program Change#	Voice Name
	MSB	LSB		
043	000	112	034	Pick Bass
044	000	112	035	Fretless Bass
045	000	112	036	Slap Bass
046	000	112	038	Synth Bass
047	000	113	038	Hi-Q Bass
048	000	113	039	Dance Bass
STRINGS				
049	000	112	048	String Ensemble
050	000	112	049	Chamber Strings
051	000	112	050	Synth Strings
052	000	113	049	Slow Strings
053	000	112	044	Tremolo Strings
054	000	112	045	Pizzicato Strings
055	000	112	055	Orchestra Hit
056	000	112	040	Violin
057	000	112	042	Cello
058	000	112	043	Contrabass
059	000	112	105	Banjo
060	000	112	046	Harp
CHOIR				
061	000	112	052	Choir
062	000	113	052	Vocal Ensemble
063	000	112	053	Vox Humana
064	000	112	054	Air Choir
SAXOPHONE				
065	000	112	064	Soprano Sax
066	000	112	065	Alto Sax
067	000	117	066	Sweet Tenor
068	000	114	066	Breathy Tenor
069	000	112	066	Tenor Sax
070	000	112	067	Baritone Sax
071	000	112	068	Oboe
072	000	112	069	English Horn
073	000	112	070	Bassoon
074	000	112	071	Clarinet
TRUMPET				
075	000	112	056	Trumpet
076	000	112	059	Muted Trumpet
077	000	112	057	Trombone
078	000	113	057	Trombone Section
079	000	112	060	French Horn
080	000	112	058	Tuba
BRASS				
081	000	112	061	Brass Section
082	000	113	061	Big Band Brass
083	000	119	061	Mellow Horns
084	000	112	062	Synth Brass
085	000	113	062	Jump Brass
086	000	114	062	Techno Brass

Voice List

Voice No.	Bank Select		MIDI Program Change#	Voice Name
	MSB	LSB		
FLUTE				
087	000	114	073	Sweet Flute
088	000	112	073	Flute
089	000	112	072	Piccolo
090	000	112	075	Pan Flute
091	000	112	074	Recorder
092	000	112	079	Ocarina
SYNTH LEAD				
093	000	112	080	Square Lead
094	000	112	081	Sawtooth Lead
095	000	112	085	Voice Lead
096	000	112	098	Star Dust
097	000	112	100	Brightness
098	000	115	081	Analogon
099	000	119	081	Fargo
SYNTH PAD				
100	000	112	088	Fantasia
101	000	113	100	Bell Pad
102	000	112	091	Xenon Pad
103	000	112	094	Equinox
104	000	113	089	Dark Moon
PERCUSSION				
105	000	112	011	Vibraphone
106	000	112	012	Marimba
107	000	112	013	Xylophone
108	000	112	114	Steel Drums
109	000	112	08	Celesta
110	000	112	014	Tubular Bells
111	000	112	047	Timpani
112	000	112	010	Music Box
SPLIT				
113	000	112	000	Acoustic Bass/Live! Grand
114	000	112	001	Finger Bass /Grand Piano
115	000	112	005	Fretless Bass/DX Modern Elec. Piano
116	000	112	011	Acoustic Bass/Vibraphone
117	000	113	061	Fretless Bass/Brass Section
118	000	112	082	Analogon/Sawtooth Lead
119	000	112	007	Slap Bass/Clavi
120	000	112	073	Classical Guitar/Sweet Flute
121	000	112	000	String Ensemble/Live! Grand
122	000	112	052	Vox Humana/Choir
DRUM KITS				
123	127	000	000	Standard Kit 1
124	127	000	001	Standard Kit 2
125	127	000	008	Room Kit
126	127	000	016	Rock Kit
127	127	000	024	Electronic Kit
128	127	000	025	Analog Kit
129	127	000	027	Dance Kit
130	127	000	032	Jazz Kit
131	127	000	040	Brush Kit
132	127	000	048	Symphony Kit
133	126	000	000	SFX Kit 1
134	126	000	001	SFX Kit 2

● XG Voice List

Voice No.	Bank Select		MIDI Program Change#	Voice Name
	MSB	LSB		
PIANO				
135	000	000	000	Grand Piano
136	000	001	000	Grand Piano KSP
137	000	018	000	Mellow Grand Piano
138	000	040	000	Piano Strings
139	000	041	000	Dream
140	000	000	001	Bright Piano
141	000	001	001	Bright Piano KSP
142	000	000	002	Electric Grand Piano
143	000	001	002	Electric Grand Piano KSP
144	000	032	002	Detuned CP80
145	000	040	002	Layered CP 1
146	000	041	002	Layered CP 2
147	000	000	003	Honky-tonk Piano
148	000	001	003	Honky-tonk Piano KSP
149	000	000	004	Electric Piano 1
150	000	001	004	Electric Piano 1 KSP
151	000	018	004	Mellow Electric Piano 1
152	000	032	004	Chorus Electric Piano 1
153	000	040	004	Hard Electric Piano
154	000	045	004	Velocity Crossfade Electric Piano 1
155	000	064	004	60's Electric Piano 1
156	000	000	005	Electric Piano 2
157	000	001	005	Electric Piano 2 KSP
158	000	032	005	Chorus Electric Piano 2
159	000	033	005	DX Electric Piano Hard
160	000	034	005	DX Legend
161	000	040	005	DX Phase Electric Piano
162	000	041	005	DX + Analog Electric Piano
163	000	042	005	DX Koto Electric Piano
164	000	045	005	Velocity Crossfade Electric Piano 2
165	000	000	006	Harpsichord
166	000	001	006	Harpsichord KSP
167	000	025	006	Harpsichord 2
168	000	035	006	Harpsichord 3
169	000	000	007	Clavi
170	000	001	007	Clavi KSP
171	000	027	007	Clavi Wah
172	000	064	007	Pulse Clavi
173	000	065	007	Pierce Clavi
CHROMATIC				
174	000	000	008	Celesta
175	000	000	009	Glockenspiel
176	000	000	010	Music Box
177	000	064	010	Orgel
178	000	000	011	Vibraphone
179	000	001	011	Vibraphone KSP
180	000	045	011	Hard Vibraphone
181	000	000	012	Marimba
182	000	001	012	Marimba KSP
183	000	064	012	Sine Marimba
184	000	097	012	Balimba
185	000	098	012	Log Drums
186	000	000	013	Xylophone
187	000	000	014	Tubular Bells
188	000	096	014	Church Bells

Voice No.	Bank Select		MIDI Program Change#	Voice Name
	MSB	LSB		
189	000	097	014	Carillon
190	000	000	015	Dulcimer
191	000	035	015	Dulcimer 2
192	000	096	015	Cimbalom
193	000	097	015	Santur
ORGAN				
194	000	000	016	DrawOrg
195	000	032	016	Detuned DrawOrg
196	000	033	016	60's DrawOrg 1
197	000	034	016	60's DrawOrg 2
198	000	035	016	70's DrawOrg 1
199	000	036	016	DrawOrg 2
200	000	037	016	60's DrawOrg 3
201	000	038	016	Even Bar
202	000	040	016	16+2"2/3
203	000	064	016	Organ Bass
204	000	065	016	70's DrawOrg 2
205	000	066	016	Cheezy Organ
206	000	067	016	DrawOrg 3
207	000	000	017	Percussive Organ
208	000	024	017	70's Percussive Organ
209	000	032	017	Detuned Percussive Organ
210	000	033	017	Light Organ
211	000	037	017	Percussive Organ 2
212	000	000	018	Rock Organ
213	000	064	018	Rotary Organ
214	000	065	018	Slow Rotary
215	000	066	018	Fast Rotary
216	000	000	019	Church Organ
217	000	032	019	Church Organ 3
218	000	035	019	Church Organ 2
219	000	040	019	Notre Dame
220	000	064	019	Organ Flute
221	000	065	019	Tremolo Organ Flute
222	000	000	020	Reed Organ
223	000	040	020	Puff Organ
224	000	000	021	Accordion
225	000	032	021	Accord It
226	000	000	022	Hamonica
227	000	032	022	Harmonica 2
228	000	000	023	Tango Accordion
229	000	064	023	Tango Accordion 2
GUITAR				
230	000	000	024	Nylon Guitar
231	000	016	024	Nylon Guitar 2
232	000	025	024	Nylon Guitar 3
233	000	043	024	Velocity Guitar Harmonics
234	000	096	024	Ukulele
235	000	000	025	Steel Guitar
236	000	016	025	Steel Guitar 2
237	000	035	025	12-string Guitar
238	000	040	025	Nylon & Steel Guitar
239	000	041	025	Steel Guitar with Body Sound
240	000	096	025	Mandolin
241	000	000	026	Jazz Guitar
242	000	018	026	Mellow Guitar
243	000	032	026	Jazz Amp
244	000	000	027	Clean Guitar

Voice No.	Bank Select		MIDI Program Change#	Voice Name
	MSB	LSB		
245	000	032	027	Chorus Guitar
246	000	000	028	Muted Guitar
247	000	040	028	Funk Guitar 1
248	000	041	028	Muted Steel Guitar
249	000	043	028	Funk Guitar 2
250	000	045	028	Jazz Man
251	000	000	029	Overdriven Guitar
252	000	043	029	Guitar Pinch
253	000	000	030	Distortion Guitar
254	000	040	030	Feedback Guitar
255	000	041	030	Feedback Guitar 2
256	000	000	031	Guitar Harmonics
257	000	065	031	Guitar Feedback
258	000	066	031	Guitar Harmonics 2
BASS				
259	000	000	032	Acoustic Bass
260	000	040	032	Jazz Rhythm
261	000	045	032	Velocity Crossfade Upright Bass
262	000	000	033	Finger Bass
263	000	018	033	Finger Dark
264	000	027	033	Flange Bass
265	000	040	033	Bass & Distorted Electric Guitar
266	000	043	033	Finger Slap Bass
267	000	045	033	Finger Bass 2
268	000	065	033	Modulated Bass
269	000	000	034	Pick Bass
270	000	028	034	Muted Pick Bass
271	000	000	035	Fretless Bass
272	000	032	035	Fretless Bass 2
273	000	033	035	Fretless Bass 3
274	000	034	035	Fretless Bass 4
275	000	096	035	Synth Fretless
276	000	097	035	Smooth Fretless
277	000	000	036	Slap Bass 1
278	000	027	036	Resonant Slap
279	000	032	036	Punch Thumb Bass
280	000	000	037	Slap Bass 2
281	000	043	037	Velocity Switch Slap
282	000	000	038	Synth Bass 1
283	000	018	038	Synth Bass 1 Dark
284	000	020	038	Fast Resonant Bass
285	000	024	038	Acid Bass
286	000	035	038	Clavi Bass
287	000	040	038	Techno Synth Bass
288	000	064	038	Orbiter
289	000	065	038	Square Bass
290	000	066	038	Rubber Bass
291	000	096	038	Hammer
292	000	000	039	Synth Bass 2
293	000	006	039	Mellow Synth Bass
294	000	012	039	Sequenced Bass
295	000	018	039	Click Synth Bass
296	000	019	039	Synth Bass 2 Dark
297	000	032	039	Smooth Synth Bass
298	000	040	039	Modular Synth Bass
299	000	041	039	DX Bass
300	000	064	039	X Wire Bass

Voice List

Voice No.	Bank Select		MIDI Program Change#	Voice Name
	MSB	LSB		
STRING				
301	000	000	040	Violin
302	000	008	040	Slow Violin
303	000	000	041	Viola
304	000	000	042	Cello
305	000	000	043	Contrabass
306	000	000	044	Tremolo Strings
307	000	008	044	Slow Tremolo Strings
308	000	040	044	Suspense Strings
309	000	000	045	Pizzicato Strings
310	000	000	046	Orchestral Harp
311	000	040	046	Yang Chin
312	000	000	047	Timpani
ENSEMBLE				
313	000	000	048	Strings 1
314	000	003	048	Stereo Strings
315	000	008	048	Slow Strings
316	000	024	048	Arco Strings
317	000	035	048	60's Strings
318	000	040	048	Orchestra
319	000	041	048	Orchestra 2
320	000	042	048	Tremolo Orchestra
321	000	045	048	Velocity Strings
322	000	000	049	Strings 2
323	000	003	049	Stereo Slow Strings
324	000	008	049	Legato Strings
325	000	040	049	Warm Strings
326	000	041	049	Kingdom
327	000	064	049	70's Strings
328	000	65	049	String Ensemble 3
329	000	000	050	Synth Strings 1
330	000	027	050	Resonant Strings
331	000	064	050	Synth Strings 4
332	000	065	050	Synth Strings 5
333	000	000	051	Synth Strings 2
334	000	000	052	Choir Aahs
335	000	003	052	Stereo Choir
336	000	016	052	Choir Aahs 2
337	000	032	052	Mellow Choir
338	000	040	052	Choir Strings
339	000	000	053	Voice Oohs
340	000	000	054	Synth Voice
341	000	040	054	Synth Voice 2
342	000	041	054	Choral
343	000	064	054	Analog Voice
344	000	000	055	Orchestra Hit
345	000	035	055	Orchestra Hit 2
346	000	064	055	Impact
BRASS				
347	000	000	056	Trumpet
348	000	016	056	Trumpet 2
349	000	017	056	Bright Trumpet
350	000	032	056	Warm Trumpet
351	000	000	057	Trombone
352	000	018	057	Trombone 2
353	000	000	058	Tuba
354	000	016	058	Tuba 2
355	000	000	059	Muted Trumpet
356	000	000	060	French Horn

Voice No.	Bank Select		MIDI Program Change#	Voice Name
	MSB	LSB		
357	000	006	060	French Horn Solo
358	000	032	060	French Horn 2
359	000	037	060	Horn Orchestra
360	000	000	061	Brass Section
361	000	035	061	Trumpet & Trombone Section
362	000	040	061	Brass Section 2
363	000	041	061	High Brass
364	000	042	061	Mellow Brass
365	000	000	062	Synth Brass 1
366	000	012	062	Quack Brass
367	000	020	062	Resonant Synth Brass
368	000	024	062	Poly Brass
369	000	027	062	Synth Brass 3
370	000	032	062	Jump Brass
371	000	045	062	Analog Velocity Brass 1
372	000	064	062	Analog Brass 1
373	000	000	063	Synth Brass 2
374	000	018	063	Soft Brass
375	000	040	063	Synth Brass 4
376	000	041	063	Choir Brass
377	000	045	063	Analog Velocity Brass 2
378	000	064	063	Analog Brass 2
REED				
379	000	000	064	Soprano Sax
380	000	000	065	Alto Sax
381	000	040	065	Sax Section
382	000	043	065	Hyper Alto Sax
383	000	000	066	Tenor Sax
384	000	040	066	Breathy Tenor Sax
385	000	041	066	Soft Tenor Sax
386	000	064	066	Tenor Sax 2
387	000	000	067	Baritone Sax
388	000	000	068	Oboe
389	000	000	069	English Horn
390	000	000	070	Bassoon
391	000	000	071	Clarinet
PIPE				
392	000	000	072	Piccolo
393	000	000	073	Flute
394	000	000	074	Recorder
395	000	000	075	Pan Flute
396	000	000	076	Blown Bottle
397	000	000	077	Shakuhachi
398	000	000	078	Whistle
399	000	000	079	Ocarina
SYNTH LEAD				
400	000	000	080	Square Lead
401	000	006	080	Square Lead 2
402	000	008	080	LM Square
403	000	018	080	Hollow
404	000	019	080	Shroud
405	000	064	080	Mellow
406	000	065	080	Solo Sine
407	000	066	080	Sine Lead
408	000	000	081	Sawtooth Lead
409	000	006	081	Sawtooth Lead 2
410	000	008	081	Thick Sawtooth
411	000	018	081	Dynamic Sawtooth
412	000	019	081	Digital Sawtooth

Voice No.	Bank Select		MIDI Program Change#	Voice Name
	MSB	LSB		
413	000	020	081	Big Lead
414	000	024	081	Heavy Synth
415	000	025	081	Waspy Synth
416	000	040	081	Pulse Sawtooth
417	000	041	081	Dr. Lead
418	000	045	081	Velocity Lead
419	000	096	081	Sequenced Analog
420	000	000	082	Calliope Lead
421	000	065	082	Pure Pad
422	000	000	083	Chiff Lead
423	000	064	083	Rubby
424	000	000	084	Charang Lead
425	000	064	084	Distorted Lead
426	000	065	084	Wire Lead
427	000	000	085	Voice Lead
428	000	024	085	Synth Aahs
429	000	064	085	Vox Lead
430	000	000	086	Fifths Lead
431	000	035	086	Big Five
432	000	000	087	Bass & Lead
433	000	016	087	Big & Low
434	000	064	087	Fat & Perky
435	000	065	087	Soft Whirl
SYNTH PAD				
436	000	000	088	New Age Pad
437	000	064	088	Fantasy
438	000	000	089	Warm Pad
439	000	016	089	Thick Pad
440	000	017	089	Soft Pad
441	000	018	089	Sine Pad
442	000	064	089	Horn Pad
443	000	065	089	Rotary Strings
444	000	000	090	Poly Synth Pad
445	000	064	090	Poly Pad 80
446	000	065	090	Click Pad
447	000	066	090	Analog Pad
448	000	067	090	Square Pad
449	000	000	091	Choir Pad
450	000	064	091	Heaven
451	000	066	091	Itopia
452	000	067	091	CC Pad
453	000	000	092	Bowed Pad
454	000	064	092	Glacier
455	000	065	092	Glass Pad
456	000	000	093	Metallic Pad
457	000	064	093	Tine Pad
458	000	065	093	Pan Pad
459	000	000	094	Halo Pad
460	000	000	095	Sweep Pad
461	000	020	095	Shwimmer
462	000	027	095	Converge
463	000	064	095	Polar Pad
464	000	066	095	Celestial
SYNTH EFFECTS				
465	000	000	096	Rain
466	000	045	096	Clavi Pad
467	000	064	096	Harmo Rain
468	000	065	096	African Wind
469	000	066	096	Carib
470	000	000	097	Sound Track

Voice No.	Bank Select		MIDI Program Change#	Voice Name
	MSB	LSB		
471	000	027	097	Prologue
472	000	064	097	Ancestral
473	000	000	098	Crystal
474	000	012	098	Synth Drum Comp
475	000	014	098	Popcorn
476	000	018	098	Tiny Bells
477	000	035	098	Round Glockenspiel
478	000	040	098	Glockenspiel Chimes
479	000	041	098	Clear Bells
480	000	042	098	Chorus Bells
481	000	064	098	Synth Mallet
482	000	065	098	Soft Crystal
483	000	066	098	Loud Glockenspiel
484	000	067	098	Christmas Bells
485	000	068	098	Vibraphone Bells
486	000	069	098	Digital Bells
487	000	070	098	Air Bells
488	000	071	098	Bell Harp
489	000	072	098	Gamelimba
490	000	000	099	Atmosphere
491	000	018	099	Warm Atmosphere
492	000	019	099	Hollow Release
493	000	040	099	Nylon Electric Piano
494	000	064	099	Nylon Harp
495	000	065	099	Harp Vox
496	000	066	099	Atmosphere Pad
497	000	067	099	Planet
498	000	000	100	Brightness
499	000	064	100	Fantasy Bells
500	000	096	100	Smokey
501	000	000	101	Goblins
502	000	064	101	Goblins Synth
503	000	065	101	Creeper
504	000	066	101	Ring Pad
505	000	067	101	Ritual
506	000	068	101	To Heaven
507	000	070	101	Night
508	000	071	101	Glisten
509	000	096	101	Bell Choir
510	000	000	102	Echoes
511	000	008	102	Echoes 2
512	000	014	102	Echo Pan
513	000	064	102	Echo Bells
514	000	065	102	Big Pan
515	000	066	102	Synth Piano
516	000	067	102	Creation
517	000	068	102	Star Dust
518	000	069	102	Resonant & Panning
519	000	000	103	Sci-Fi
520	000	064	103	Starz
WORLD				
521	000	000	104	Sitar
522	000	032	104	Detuned Sitar
523	000	035	104	Sitar 2
524	000	096	104	Tambra
525	000	097	104	Tamboura
526	000	000	105	Banjo
527	000	028	105	Muted Banjo
528	000	096	105	Rabab
529	000	097	105	Gopichant

Voice List

Voice No.	Bank Select		MIDI Program Change#	Voice Name
	MSB	LSB		
530	000	098	105	Oud
531	000	000	106	Shamisen
532	000	000	107	Koto
533	000	096	107	Taisho-kin
534	000	097	107	Kanoon
535	000	000	108	Kalimba
536	000	000	109	Bagpipe
537	000	000	110	Fiddle
538	000	000	111	Shanai
539	000	064	111	Shanai 2
540	000	096	111	Pungi
541	000	097	111	Hichiriki
PERCUSSIVE				
542	000	000	112	Tinkle Bell
543	000	096	112	Bonang
544	000	097	112	Altair
545	000	098	112	Gamelan Gongs
546	000	099	112	Stereo Gamelan Gongs
547	000	100	112	Rama Cymbal
548	000	101	112	Asian Bells
549	000	000	113	Agogo
550	000	000	114	Steel Drums
551	000	097	114	Glass Percussion
552	000	098	114	Thai Bells
553	000	000	115	Woodblock
554	000	096	115	Castanets
555	000	000	116	Taiko Drum
556	000	096	116	Gran Cassa
557	000	000	117	Melodic Tom
558	000	064	117	Melodic Tom 2
559	000	065	117	Real Tom
560	000	066	117	Rock Tom
561	000	000	118	Synth Drum
562	000	064	118	Analog Tom
563	000	065	118	Electronic Percussion
564	000	000	119	Reverse Cymbal
SOUND EFFECTS				
565	000	000	120	Fret Noise
566	000	000	121	Breath Noise
567	000	000	122	Seashore
568	000	000	123	Bird Tweet
569	000	000	124	Telephone Ring
570	000	000	125	Helicopter
571	000	000	126	Applause
572	000	000	127	Gunshot
573	064	000	000	Cutting Noise
574	064	000	001	Cutting Noise 2
575	064	000	003	String Slap
576	064	000	016	Flute Key Click
577	064	000	032	Shower
578	064	000	033	Thunder
579	064	000	034	Wind
580	064	000	035	Stream
581	064	000	036	Bubble
582	064	000	037	Feed
583	064	000	048	Dog
584	064	000	049	Horse
585	064	000	050	Bird Tweet 2
586	064	000	054	Ghost

Voice No.	Bank Select		MIDI Program Change#	Voice Name
	MSB	LSB		
587	064	000	055	Maou
588	064	000	064	Phone Call
589	064	000	065	Door Squeak
590	064	000	066	Door Slam
591	064	000	067	Scratch Cut
592	064	000	068	Scratch Split
593	064	000	069	Wind Chime
594	064	000	070	Telephone Ring 2
595	064	000	080	Car Engine Ignition
596	064	000	081	Car Tires Squeal
597	064	000	082	Car Passing
598	064	000	083	Car Crash
599	064	000	084	Siren
600	064	000	085	Train
601	064	000	086	Jet Plane
602	064	000	087	Starship
603	064	000	088	Burst
604	064	000	089	Roller Coaster
605	064	000	090	Submarine
606	064	000	096	Laugh
607	064	000	097	Scream
608	064	000	098	Punch
609	064	000	099	Heartbeat
610	064	000	100	Footsteps
611	064	000	112	Machine Gun
612	064	000	113	Laser Gun
613	064	000	114	Explosion
614	064	000	115	Firework

● DJ Voice List

Voice No.	Bank Select		MIDI Program Change#	Voice Name
	MSB	LSB		
DJ				
615	000	123	118	DJ Set 1
616	000	123	119	DJ Set 2
617	000	123	120	DJ Set 3
618	000	123	121	DJ Set 4
619	000	123	122	DJ Set 5

● DJ Voice List

Voice No.		615	616	617	618	619
MSB/LSB/PC		0/123/118	0/123/119	0/123/120	0/123/121	0/123/122
Note No.	Note	DJ Set 1	DJ Set 2	DJ Set 3	DJ Set 4	DJ Set 5
036	C 1	BD Analog H	Bass Drum Soft	BD Analog H	BD Analog H	BD Analog H
037	C# 1	Analog Side Stick	Side Stick	Analog Side Stick	Analog Side Stick	Analog Side Stick
038	D 1	Analog Snare 1	Snare M	Analog Snare 1	Analog Snare 1	Analog Snare 1
039	D# 1	Hand Clap	Hand Clap	Hand Clap	Hand Clap	Hand Clap
040	E 1	Analog Snare 2	Snare H Hard	Analog Snare 2	Analog Snare 2	Analog Snare 2
041	F 1	Analog Tom 1	Floor Tom L	Analog Tom 1	Analog Tom 1	Analog Tom 1
042	F# 1	Analog HH Closed 1	Hi-Hat Closed	Analog HH Closed 1	Analog HH Closed 1	Analog HH Closed 1
043	G 1	Analog Tom 2	Floor Tom H	Analog Tom 2	Analog Tom 2	Analog Tom 2
044	G# 1	Analog HH Closed 2	Hi-Hat Pedal	Analog HH Closed 2	Analog HH Closed 2	Analog HH Closed 2
045	A 1	Analog Tom 3	Low Tom	Analog Tom 3	Analog Tom 3	Analog Tom 3
046	A# 1	Analog HH Open	Hi-Hat Open	Analog HH Open	Analog HH Open	Analog HH Open
047	B 1	Analog Tom 4	Mid Tom L	Analog Tom 4	Analog Tom 4	Analog Tom 4
048	C 2	Analog Tom 5	Mid Tom H	Analog Tom 5	Analog Tom 5	Analog Tom 5
049	C# 2	Analog Cymbal	Crash Cymbal 1	Analog Cymbal	Analog Cymbal	Analog Cymbal
050	D 2	Analog Tom 6	High Tom	Analog Tom 6	Analog Tom 6	Analog Tom 6
051	D# 2	Ride Cymbal 1	Ride Cymbal 1	Ride Cymbal 1	Ride Cymbal 1	Ride Cymbal 1
052	E 2	Chinese Cymbal	Chinese Cymbal	Chinese Cymbal	Chinese Cymbal	Chinese Cymbal
053	F 2	Ride Cymbal Cup	Ride Cymbal Cup	Ride Cymbal Cup	Ride Cymbal Cup	Ride Cymbal Cup
054	F# 2	Tambourine	Tambourine	Tambourine	Tambourine	Tambourine
055	G 2					
056	G# 2					
057	A 2					
058	A# 2					
059	B 2					
060	C 3					
061	C# 3					
062	D 3					
063	D# 3	Ohh2	FX01	ORCH	signal	Go
064	E 3					
065	F 3					
066	F# 3					
067	G 3					
068	G# 3					
069	A 3					
070	A# 3					
071	B 3					
072	C 4					
073	C# 4					
074	D 4					
075	D# 4					
076	E 4					
077	F 4	FX02	Onemoretime	Onemoretime	Uhh-Hit	Huea
078	F# 4					
079	G 4					
080	G# 4					
081	A 4					
082	A# 4					
083	B 4					
084	C 5	Joo	Go	GetUp	Huihu	GetUp
085	C# 5	Reverse	Ohh2	signal	Joo	Reverse
086	D 5	Huihu	Heau	Joo	ComeOn	Joo
087	D# 5	FXTBrs	FX02	FXTBrs	Onemoretime	FX01
088	E 5	Huea	Huihu	Go	Go	Ohh1
089	F 5	GetUp	GetUp	Huihu	GetUp	Ohh2
090	F# 5	Ohh1	Reverse	FX01	Huea	Onemoretime
091	G 5	Go	signal	ComeOn	Ohh2	ComeOn
092	G# 5	Scratch 1	Scratch 1	Scratch 1	Scratch 1	Scratch 1
093	A 5	Scratch 2	Scratch 2	Scratch 2	Scratch 2	Scratch 2
094	A# 5	Scratch 3	Scratch 3	Scratch 3	Scratch 3	Scratch 3
095	B 5	Scratch 4	Scratch 4	Scratch 4	Scratch 4	Scratch 4
096	C 6	Scratch 5	Scratch 5	Scratch 5	Scratch 5	Scratch 5



Style List

Serial No.	Style Name
8 BEAT	
001	8BeatModern
002	60'sGtrPop
003	8BeatAdria
004	60's8Beat
005	8Beat
006	OffBeat
007	60'sRock
008	HardRock
009	RockShuffle
010	8BeatRock
16 BEAT	
011	16Beat
012	PopShuffle1
013	PopShuffle2
014	GuitarPop
015	16BtUptempo
016	KoolShuffle
017	JazzRock
018	HipHopLight
BALLAD	
019	PianoBallad
020	LoveSong
021	6/8ModernEP
022	6/8SlowRock
023	OrganBallad
024	PopBallad
025	16BeatBallad1
026	16BeatBallad2
DANCE	
027	EuroTrance
028	Ibiza
029	HouseMusik
030	SwingHouse
031	TechnoPolis
032	Clubdance
033	ClubLatin
034	Garage1
035	Garage2
036	TechnoParty
037	UKPop
038	HipHopGroove
039	HipShuffle
040	HipHopPop
DISCO	
041	70'sDisco1
042	70'sDisco2
043	LatinDisco
044	DiscoPhilly
045	SaturdayNight
046	DiscoChocolate
047	DiscoHands

Serial No.	Style Name
SWING & JAZZ	
048	BigBandFast
049	BigBandMid
050	BigBandBallad
051	BigBandShfl
052	JazzClub
053	Swing1
054	Swing2
055	Five/Four
056	JazzBallad
057	Dixieland
058	Ragtime
059	AfroCuban
060	Charleston
R & B	
061	Soul
062	DetroitPop1
063	60'sRock&Roll
064	6/8Soul
065	CrocoTwist
066	Rock&Roll
067	DetroitPop2
068	BoogieWoogie
069	ComboBoogie
070	6/8Blues
COUNTRY	
071	Country8Beat
072	CountryPop
073	CountrySwing
074	Country2/4
075	CowboyBoogie
076	CountryShuffle
077	Bluegrass
LATIN	
078	BrazilianSamba
079	BossaNova
080	PopBossa
081	Tijuana
082	DiscoLatin
083	Mambo
084	Salsa
085	Beguine
086	GypsyRumba
087	RmbFlamenca
088	Rumbalsland
089	Reggae
BALLROOM	
090	VienneseWaltz
091	EnglishWaltz
092	Slowfox
093	Foxtrot
094	Quickstep

Serial No.	Style Name
095	Tango
096	Pasodoble
097	Samba
098	ChaChaCha
099	Rumba
100	Jive
TRADITIONAL	
101	USMarch
102	6/8March
103	GermanMarch
104	PolkaPop
105	OberPolka
106	Tarantella
107	Showtune
108	ChristmasSwing
109	ChristmasWaltz
110	ScottishReel
111	Hawaiian
WALTZ	
112	GuitarSerenade
113	SwingWaltz
114	JazzWaltz1
115	JazzWaltz2
116	CountryWaltz
117	OberWalzer
118	Musette
DJ	
119	DJ-HipHop
120	DJ-DanceSwing
121	DJ-House
122	DJ-GarageHouse
123	DJ-PopR&B
PIANIST	
124	Stride
125	PianoSwing
126	PianoRag
127	Arpeggio
128	Musical
129	Habanera
130	SlowRock
131	8BeatPianoBallad
132	PianoMarch
133	6/8PianoMarch
134	PianoWaltz
135	PianoBeguine



Music Database List

MDB No.	MDB Name
POP HITS	
001	AlvFever
002	Croco Rk
003	DayPdise
004	EasySday
005	GoMyWay
006	HowDeep!
007	HurryLuv
008	I'm Torn
009	Imagine
010	ISurvive
011	JustCall
012	JustWay
013	NikitTrp
014	ProudGtr
015	SailingSx
016	Sept.Pop
017	SultanSw
018	SweetLrd
019	ThnkMsic
020	TitanicH
021	WatchGrl
022	WhatALoo
023	WhitePle
024	YestDGtr
SWING & JAZZ	
025	Alex Rag
026	Blue Set
027	DayOfW&R
028	HighMoon
029	MistySax
030	MoonLit
031	New York
032	PanthrSw
033	PatrolBr
034	PatrolSx
035	PetiteCl
036	RedRoses
037	SaintMch
038	SatinWd
039	SaxMood
040	SF Heart
041	ShearJz
042	Showbiz
043	SplnkyTb
044	SunnySde
045	TstHoney
046	TwoFoot5
047	WhatsNew
048	Wild Cat
049	WondrLnd
EASY LISTENING	
050	BlackFst
051	CalliBlue
052	CiaoCpri
053	Close2U
054	DAMorStr
055	DolanesM
056	ElCondor
057	Entrtain
058	Frippers
059	LuckySax
060	LuvStory
061	MyPrince
062	OSoleMio
063	PalomaGt
064	PuppetBr
065	Raindrop
066	RedMouln
067	R'ticGtr
068	Schiwago
069	ShadowGt
070	SingRain
071	SmallWld

MDB No.	MDB Name
072	SpkSoft
073	SpnishEy
074	StrangeN
075	TieRibbn
076	TimeGoes
077	WhteXmas
078	WishStar
079	WondrWld
ROMANTIC BALLADS	
080	AdelineB
081	ArgenCry
082	BeautBdy
083	BI Bayou
084	CatMemry
085	CavaSolo
086	E Weiss
087	ElvGhett
088	Feeling
089	Fly Away
090	Fnl Date
091	GreenSlv
092	GtCncert
093	HrdToSay
094	LonlyPan
095	MBoxDnce
096	Mn Rivr
097	Norw.Flt
098	OnMyMnd
099	OverRbow
100	Red Lady
101	ReleseMe
102	SavingLv
103	Shore Cl
104	SierraMd
105	SilverMn
106	SmokyEye
107	SndOfSil
108	TblWater
109	WhisprSx
ROCK & FUSION	
110	DavAgain
111	JumpRock
112	OyComCha
113	PickUpPc
114	RdRiverR
115	SatsfyGt
116	Sheriff
117	SmokeWtr
118	TwistAgn
119	VenusPop
RHYTHM & BLUES	
120	AmazingG
121	BoogiePf
122	Clock Rk
123	CU later
124	HappyDay
125	JohnnyB
126	MercyBrs
127	RisingSn
128	S Preems
129	SuperStv
130	Yeh Orgn
HIP HOP HOUSE	
131	2 of US
132	B Leave
133	Back St
134	FunkyTwn
135	KillSoft
136	MiamiTrn
137	Nine PM
138	SharpRap
139	SingBack
140	StrandD

MDB No.	MDB Name
LATIN NIGHTS	
141	BambaBrs
142	BambaFit
143	BeHappy!
144	CopaLola
145	DayNight
146	Ipanema
147	MarinaAc
148	MuchoTrb
149	SmoothLt
150	SunOfLif
151	Sunshine
152	Tico Org
153	TrbWave
COUNTRY & WESTERN	
154	BlownWnd
155	Bonanza
156	BoxerGtr
157	CntryRds
158	GreenGrs
159	Jambala
160	LondonSt
161	LooseEL
162	TopWorld
163	YlwRose
DISCO & PARTY	
164	AlhHwaii
165	Babylon
166	Barbados
167	BirdySyn
168	FestaMex
169	HandsPty
170	LuvTheme
171	ModrnTlk
172	NxtAlice
173	PalomaFl
174	PubPiano
175	Tijuana
176	Why MCA?
BALLROOM	
177	BrazilBr
178	CherryBr
179	CherryOr
180	DanubeWv
181	MantoStr
182	SandmnFx
183	SundyNvr
184	TangoPiz
185	Tea4Two
186	TulipWtz
187	YesSirQk
TRADITIONAL	
188	AlpenTri
189	Balalaik
190	Ceilidh
191	CielPari
192	Cl Polka
193	Comrades
194	Funiculi
195	HappyPlk
196	Herzlin
197	HornPipe
198	JinglBel
199	Kufstein
200	MexiHat
201	MickyFit
202	NavyAway
203	RlBarrel
204	SnowWtz
205	StarMrch
206	WashPost
207	WdCuttrs
208	XmasWalz



Drum Kit List

- " " indicates that the drum sound is the same as "Standard Kit 1".
- Each percussion voice uses one note.
- The MIDI Note # and Note are actually one octave lower than keyboard Note # and Note. For example, in "123: Standard Kit 1", the "Seq Click H" (Note# 36/Note C1) corresponds to (Note# 24/Note C0).
- Key Off: Keys marked "O" stop sounding the instant they are released.
- Voices with the same Alternate Note Number (*1 ... 4) cannot be played simultaneously. (They are designed to be played alternately with each other.)

	Voice No.				Key Off	Alternate assign	123	124	125	126	127	128
	MSB/LSB/PC						127/000/000	127/000/001	127/000/008	127/000/16	127/000/24	127/000/25
	Keyboard Note#	Note	MIDI Note#	Note			Standard Kit 1	Standard Kit 2	Room Kit	Rock Kit	Electronic Kit	Analog Kit
D0	C#0	25	C# 0	13	C# -1		3	Surdo Mute				
D0	D#0	26	D 0	14	D -1		3	Surdo Open				
E0		27	D# 0	15	D# -1			Hi Q				
F0	F#0	28	E 0	16	E -1			Whip Slap				
G0	G#0	29	F 0	17	F -1		4	Scratch Push				
A0	A#0	30	F# 0	18	F# -1		4	Scratch Pull				
B0		31	G 0	19	G -1			Finger Snap				
C1	C#1	32	G# 0	20	G# -1			Click Noise				
D1	D#1	33	A 0	21	A -1			Metronome Click				
E1		34	A# 0	22	A# -1			Metronome Bell				
F1	F#1	35	B 0	23	B -1			Seq Click L				
G1	G#1	36	C 1	24	C 0			Seq Click H				
A1	A#1	37	C# 1	25	C# 0			Brush Tap				
B1		38	D 1	26	D 0	O		Brush Swirl				
C2	C#2	39	D# 1	27	D# 0			Brush Slap				
D2	D#2	40	E 1	28	E 0	O		Brush Tap Swirl			Reverse Cymbal	Reverse Cymbal
E2		41	F 1	29	F 0	O		Snare Roll				
F2	F#2	42	F# 1	30	F# 0			Castanet			Hi Q 2	Hi Q 2
G2	G#2	43	G 1	31	G 0			Snare H Soft	Snare H Soft 2	SD Rock H	Snare L	SD Rock H
A2	A#2	44	G# 1	32	G# 0			Sticks				
B2		45	A 1	33	A 0			Bass Drum Soft			Bass Drum H	Bass Drum H
C3	C#3	46	A# 1	34	A# 0			Open Rim Shot	Open Rim Shot 2			
D3	D#3	47	B 1	35	B 0			Bass Drum Hard		Bass Drum H	BD Rock	BD Analog L
E3		48	C 2	36	C 1			Bass Drum	Bass Drum 2	BD Rock	BD Gate	BD Analog H
F3	F#3	49	C# 2	37	C# 1			Side Stick				Analog Side Stick
G3	G#3	50	D 2	38	D 1			Snare M	Snare M 2	SD Room L	SD Rock L	SD Rock L
A3	A#3	51	D# 2	39	D# 1			Hand Clap				Analog Snare 2
B3		52	E 2	40	E 1			Snare H Hard	Snare H Hard 2	SD Room H	SD Rock Rim	SD Rock H
C4	C#4	53	F 2	41	F 1			Floor Tom L		Room Tom 1	Rock Tom 1	E Tom 1
D4	D#4	54	F# 2	42	F# 1	1		Hi-Hat Closed				Analog Tom 1
E4		55	G 2	43	G 1			Floor Tom H		Room Tom 2	Rock Tom 2	E Tom 2
F4	F#4	56	G# 2	44	G# 1	1		Hi-Hat Pedal				Analog HH Closed 1
G4	G#4	57	A 2	45	A 1			Low Tom		Room Tom 3	Rock Tom 3	E Tom 3
A4	A#4	58	A# 2	46	A# 1	1		Hi-Hat Open				Analog HH Closed 2
B4		59	B 2	47	B 1			Mid Tom L		Room Tom 4	Rock Tom 4	E Tom 4
C5	C#5	60	C 3	48	C 2			Mid Tom H		Room Tom 5	Rock Tom 5	E Tom 5
D5	D#5	61	C# 3	49	C# 2			Crash Cymbal 1				Analog Tom 4
E5		62	D 3	50	D 2			High Tom		Room Tom 6	Rock Tom 6	E Tom 6
F5	F#5	63	D# 3	51	D# 2			Ride Cymbal 1				Analog Cymbal
G5	G#5	64	E 3	52	E 2			Chinese Cymbal				Analog Tom 6
A5	A#5	65	F 3	53	F 2			Ride Cymbal Cup				
B5		66	F# 3	54	F# 2			Tambourine				
C6	C#6	67	G 3	55	G 2			Splash Cymbal				
D6	D#6	68	G# 3	56	G# 2			Cowbell				Analog Cowbell
E6		69	A 3	57	A 2			Crash Cymbal 2				
F6	F#6	70	A# 3	58	A# 2			Vibraslap				
G6	G#6	71	B 3	59	B 2			Ride Cymbal 2				
A6	A#6	72	C 4	60	C 3			Bongo H				
B6		73	C# 4	61	C# 3			Bongo L				
C7	C#7	74	D 4	62	D 3			Conga H Mute				Analog Conga H
D7	D#7	75	D# 4	63	D# 3			Conga H Open				Analog Conga M
E7		76	E 4	64	E 3			Conga L				Analog Conga L
F7	F#7	77	F 4	65	F 3			Timbale H				
G7	G#7	78	F# 4	66	F# 3			Timbale L				
A7	A#7	79	G 4	67	G 3			Agogo H				
B7		80	G# 4	68	G# 3			Agogo L				
C8	C#8	81	A 4	69	A 3			Cabasa				
D8	D#8	82	A# 4	70	A# 3			Maracas				Analog Maracas
E8		83	B 4	71	B 3	O		Samba Whistle H				
F8	F#8	84	C 5	72	C 4	O		Samba Whistle L				
G8	G#8	85	C# 5	73	C# 4			Guiro Short				
A8	A#8	86	D 5	74	D 4	O		Guiro Long				
B8		87	D# 5	75	D# 4			Claves				Analog Claves
C9	C#9	88	E 5	76	E 4			Wood Block H				
D9	D#9	89	F 5	77	F 4			Wood Block L				
E9		90	F# 5	78	F# 4			Cuica Mute			Scratch Push	Scratch Push
F9	F#9	91	G 5	79	G 4			Cuica Open			Scratch Pull	Scratch Pull
G9	G#9	92	G# 5	80	G# 4	2		Triangle Mute				
A9	A#9	93	A 5	81	A 4	2		Triangle Open				
B9		94	A# 5	82	A# 4			Shaker				
C10	C#10	95	B 5	83	B 4			Jingle Bell				
D10	D#10	96	C 6	84	C 5			Bell Tree				
E10		97	C# 6	85	C# 5							
F10	F#10	98	D 6	86	D 5							
G10	G#10	99	D# 6	87	D# 5							
A10	A#10	100	E 6	88	E 5							
B10		101	F 6	89	F 5							
C11	C#11	102	F# 6	90	F# 5							
D11	D#11	103	G 6	91	G 5							

Drum Kit List

		Voice No.						123	129	130	131	132	133	134
		MSB/LSB/PC						127/000/000	127/000/27	127/000/32	127/000/40	127/000/48	126/000/000	126/000/001
		Keyboard		MIDI		Key Off	Alternate assign	Standard Kit 1	Dance Kit	Jazz Kit	Brush Kit	Symphony Kit	SFX Kit 1	SFX Kit 2
		Note#	Note	Note#	Note									
C#0		25	C# 0	13	C# -1		3	Surdo Mute						
D0		26	D 0	14	D -1		3	Surdo Open						
D#0		27	D# 0	15	D# -1			Hi Q						
E0		28	E 0	16	E -1			Whip Slap						
F0		29	F 0	17	F -1		4	Scratch Push						
F#0		30	F# 0	18	F# -1		4	Scratch Pull						
G0		31	G 0	19	G -1			Finger Snap						
G#0		32	G# 0	20	G# -1			Click Noise						
A0		33	A 0	21	A -1			Metronome Click						
A#0		34	A# 0	22	A# -1			Metronome Bell						
B0		35	B 0	23	B -1			Seq Click L						
C1		36	C 1	24	C 0			Seq Click H						
C#1		37	C# 1	25	C# 0			Brush Tap						
D1		38	D 1	26	D 0	O		Brush Swirl						
D#1		39	D# 1	27	D# 0			Brush Slap						
E1		40	E 1	28	E 0	O		Brush Tap Swirl	Reverse Cymbal					
F1		41	F 1	29	F 0	O		Snare Roll						
F#1		42	F# 1	30	F# 0			Castanet	Hi Q 2					
G1		43	G 1	31	G 0			Snare H Soft	AnSD Snappy	SD Jazz H Light	Brush Slap L			
G#1		44	G# 1	32	G# 0			Sticks						
A1		45	A 1	33	A 0			Bass Drum Soft	AnBD Dance-1			Bass Drum L		
A#1		46	A# 1	34	A# 0			Open Rim Shot	AnSD OpenRim					
B1		47	B 1	35	B 0			Bass Drum Hard	AnBD Dance-2			Gran Cassa		
C2		48	C 2	36	C 1			Bass Drum	AnBD Dance-3	BD Jazz	BD Jazz	Gran Cassa Mute	Cutting Noise	Phone Call
C#2		49	C# 2	37	C# 1			Side Stick	Analog Side Stick				Cutting Noise 2	Door Squeak
D2		50	D 2	38	D 1			Snare M	AnSD Q	SD Jazz L	Brush Slap	Marching Sn M		Door Slam
D#2		51	D# 2	39	D# 1			Hand Clap					String Slap	Scratch Cut
E2		52	E 2	40	E 1			Snare H Hard	AnSD Ana+Acoustic	SD Jazz M	Brush Tap	Marching Sn H		Scratch
F2		53	F 2	41	F 1			Floor Tom L	Analog Tom 1	Jazz Tom 1	Brush Tom 1	Jazz Tom 1		Wind Chime
F#2		54	F# 2	42	F# 1	1		Hi-Hat Closed	Analog HH Closed 3					Telephone Ring 2
G2		55	G 2	43	G 1			Floor Tom H	Analog Tom 2	Jazz Tom 2	Brush Tom 2	Jazz Tom 2		
G#2		56	G# 2	44	G# 1	1		Hi-Hat Pedal	Analog HH Closed 4					
A2		57	A 2	45	A 1			Low Tom	Analog Tom 3	Jazz Tom 3	Brush Tom 3	Jazz Tom 3		
A#2		58	A# 2	46	A# 1	1		Hi-Hat Open	Analog HH Open 2					
B2		59	B 2	47	B 1			Mid Tom L	Analog Tom 4	Jazz Tom 4	Brush Tom 4	Jazz Tom 4		
C3		60	C 3	48	C 2			Mid Tom H	Analog Tom 5	Jazz Tom 5	Brush Tom 5	Jazz Tom 5		
C#3		61	C# 3	49	C# 2			Crash Cymbal 1	Analog Cymbal			Hand Cym. L		
D3		62	D 3	50	D 2			High Tom	Analog Tom 6	Jazz Tom 6	Brush Tom 6	Jazz Tom 6		
D#3		63	D# 3	51	D# 2			Ride Cymbal 1				Hand Cym.Short L		
E3		64	E 3	52	E 2			Chinese Cymbal					Flute Key Click	Car Engine Ignition
F3		65	F 3	53	F 2			Ride Cymbal Cup						Car Tires Squeal
F#3		66	F# 3	54	F# 2			Tambourine						Car Passing
G3		67	G 3	55	G 2			Splash Cymbal						Car Crash
G#3		68	G# 3	56	G# 2			Cowbell	Analog Cowbell					Siren
A3		69	A 3	57	A 2			Crash Cymbal 2				Hand Cym. H		Train
A#3		70	A# 3	58	A# 2			VibraSlap						Jet Plane
B3		71	B 3	59	B 2			Ride Cymbal 2				Hand Cym.Short H		Starship
C4		72	C 4	60	C 3			Bongo H						Burst
C#4		73	C# 4	61	C# 3			Bongo L						Roller Coaster
D4		74	D 4	62	D 3			Conga H Mute	Analog Conga H					Submarine
D#4		75	D# 4	63	D# 3			Conga H Open	Analog Conga M					
E4		76	E 4	64	E 3			Conga L	Analog Conga L					
F4		77	F 4	65	F 3			Timbale H						
F#4		78	F# 4	66	F# 3			Timbale L						
G4		79	G 4	67	G 3			Agogo H						
G#4		80	G# 4	68	G# 3			Agogo L					Shower	Laugh
A4		81	A 4	69	A 3			Cabasa				Thunder	Scream	
A#4		82	A# 4	70	A# 3			Maracas	Analog Maracas			Wind	Punch	
B4		83	B 4	71	B 3	O		Samba Whistle H				Stream	Heartbeat	
C5		84	C 5	72	C 4	O		Samba Whistle L				Bubble	FootSteps	
C#5		85	C# 5	73	C# 4			Guiro Short				Feed		
D5		86	D 5	74	D 4	O		Guiro Long						
D#5		87	D# 5	75	D# 4			Claves	Analog Claves					
E5		88	E 5	76	E 4			Wood Block H						
F5		89	F 5	77	F 4			Wood Block L						
F#5		90	F# 5	78	F# 4			Cuica Mute	Scratch Push					
G5		91	G 5	79	G 4			Cuica Open	Scratch Pull					
G#5		92	G# 5	80	G# 4		2	Triangle Mute						
A5		93	A 5	81	A 4		2	Triangle Open						
A#5		94	A# 5	82	A# 4			Shaker						
B5		95	B 5	83	B 4			Jingle Bell						
C6		96	C 6	84	C 5			Bell Tree					Dog	Machine Gun
C#6		97	C# 6	85	C# 5								Horse	Laser Gun
D6		98	D 6	86	D 5								Bird Tweet 2	Explosion
D#6		99	D# 6	87	D# 5									Firework
E6		100	E 6	88	E 5									
F6		101	F 6	89	F 5									
F#6		102	F# 6	90	F# 5								Ghost	
G6		103	G 6	91	G 5								Maou	

NOTE:

*1 By default (factory settings) the DGX-500/300 ordinarily functions as a 16-channel multi-timbral tone generator, and incoming data does not affect the panel voices or panel settings. However, the MIDI messages listed below do affect the panel voices, auto accompaniment, and songs.

- MIDI Master Tuning
- System exclusive messages for changing the Reverb Type, Chorus Type, and DSP Type.

*2 Messages for these control change numbers cannot be transmitted from the DGX-500/300 itself. However, they may be transmitted when playing the accompaniment, song or using the Harmony effect.

*3 Exclusive

<GM System ON> F0H, 7EH, 7FH, 09H, 01H, F7H

- This message automatically restores all default settings for the instrument, with the exception of MIDI Master Tuning.

<MIDI Master Volume> F0H, 7FH, 7FH, 04H, 01H, II, mm, F7H

- This message allows the volume of all channels to be changed simultaneously (Universal System Exclusive).
- The values of "mm" is used for MIDI Master Tuning. (Values for "II" are ignored.)

<MIDI Master Tuning> F0H, 43H, 1nH, 27H, 30H, 00H, 00H, mm, II, cc, F7H

- This message simultaneously changes the tuning value of all channels.
- The values of "mm" and "II" are used for MIDI Master Tuning.
- The default value of "mm" and "II" are 08H and 00H, respectively. Any values can be used for "n" and "cc."

<Reverb Type> F0H, 43H, 1nH, 4CH, 02H, 01H, 00H, mmH, IIH, F7H

- mm : Reverb Type MSB
- II : Reverb Type LSB

Refer to the Effect Map (page 104) for details.

<Chorus Type> F0H, 43H, 1nH, 4CH, 02H, 01H, 20H, mmH, IIH, F7H

- mm : Chorus Type MSB
- II : Chorus Type LSB

Refer to the Effect Map (page 104) for details.

<DSP Type> F0H, 43H, 1nH, 4CH, 02H, 01H, 40H, mmH, IIH, F7H

- mm : DSP Type MSB
- II : DSP Type LSB

Refer to the Effect Map (page 104) for details.

<DRY Level> F0H, 43H, 1nH, 4CH, 08H, 0mH, 11H, IIH, F7H

- II : Dry Level
- 0m : Channel Number

*4 When the accompaniment is started, an FAH message is transmitted. When accompaniment is stopped, an FCH message is transmitted. When the clock is set to External, both FAH (accompaniment start) and FCH (accompaniment stop) are recognized.

*5 Local ON/OFF

<Local ON> Bn, 7A, 7F

<Local OFF> Bn, 7A, 00

Value for "n" is ignored.

MIDI Implementation Chart

■ Effect map

- * If the received value does not contain an effect type in the TYPE LSB, the LSB will be directed to TYPE 0.
- * The numbers in parentheses in front of the Effect Type names correspond to the number indicated in the display.
- * By using an external sequencer, which is capable of editing and transmitting the system exclusive messages and parameter changes, you can select the Reverb, Chorus and DSP effect types which are not accessible from the DGX-500/300 panel itself. When one of the effects is selected by the external sequencer, " - " will be shown on the display.

● REVERB

TYPE MSB	TYPE LSB								
	00	01	02	08	16	17	18	19	20
000	No Effect								
001	(1)Hall1					(2)Hall2			
002	Room					(3)Room1		(4)Room2	
003	Stage				(5)Stage1	(6)Stage2			
004	Plate				(7)Plate1	(8)Plate2			
005...127	No Effect								

● CHORUS

TYPE MSB	TYPE LSB								
	00	01	02	08	16	17	18	19	20
000...064	No Effect								
065	Chorus		Chorus2						
066	Celeste					Chorus1			
067	Flanger			Flanger1		Flanger2			
068...127	No Effect								

● DSP

TYPE MSB	TYPE LSB								
	00	01	02	08	16	17	18	19	20
000	No Effect								
001	(1)Hall1					(2)Hall2			
002	Room					(3)Room1		(4)Room2	
003	Stage				(5)Stage1	(6)Stage2			
004	Plate				(7)Plate1	(8)Plate2			
005	Delay L,C,R				(26)Delay L,C,R				
006	(27)Delay L,R								
007	(28)Echo								
008	(29)Cross Delay								
009	(9)Early Reflection1	(10)Early Reflection2							
010	(11)Gate Reverb								
011	(12)Reverse Gate								
012...019	No Effect								
020	(30)Karaoke								
021...064	No Effect								
065	Chorus		(14)Chorus2						
066	Celeste					(13)Chorus1			
067	Flanger			(15)Flanger1		(16)Flanger2			
068	Symphonic				(17)Symphonic				
069	Rotary Speaker				(19)Rotary Speaker1				
070	Tremolo				(21)Tremolo1				
071	Auto Pan				(24)Auto Pan		(20)Rotary Speaker2	(22)Tremolo2	(23)Guitar Tremolo
072	(18)Phaser								
073	Distortion								
074	(33)Overdrive								
075	(34)Amp Simulation				(31)Distortion Hard	(32)Distortion Soft			
076	(37)3Band EQ				(35)EQ Disco	(36)EQ Telephone			
077	(38)2Band EQ								
078	Auto Wah				(25)Auto Wah				
079...127	No Effect								

Keyboard Stand Assembly (DGX-500 only)

CAUTION

- Be careful not to confuse parts, and be sure to install all parts in the correct direction. Please assemble in accordance with the sequence given below.
- Assembly should be carried out by at least two persons.
- Be sure to use the correct screw size, as indicated above. Use of incorrect screws can cause damage.
- Be sure to tighten all screws upon completing assembly of each unit.
- To disassemble, reverse the assembly sequence given below.

Have a phillips-head (+) screwdriver ready.

The parts shown in the "Assembly Parts" illustration will be used. Follow the assembly instructions and select the parts as needed.

■ Assembly Parts (DGX-500 only)

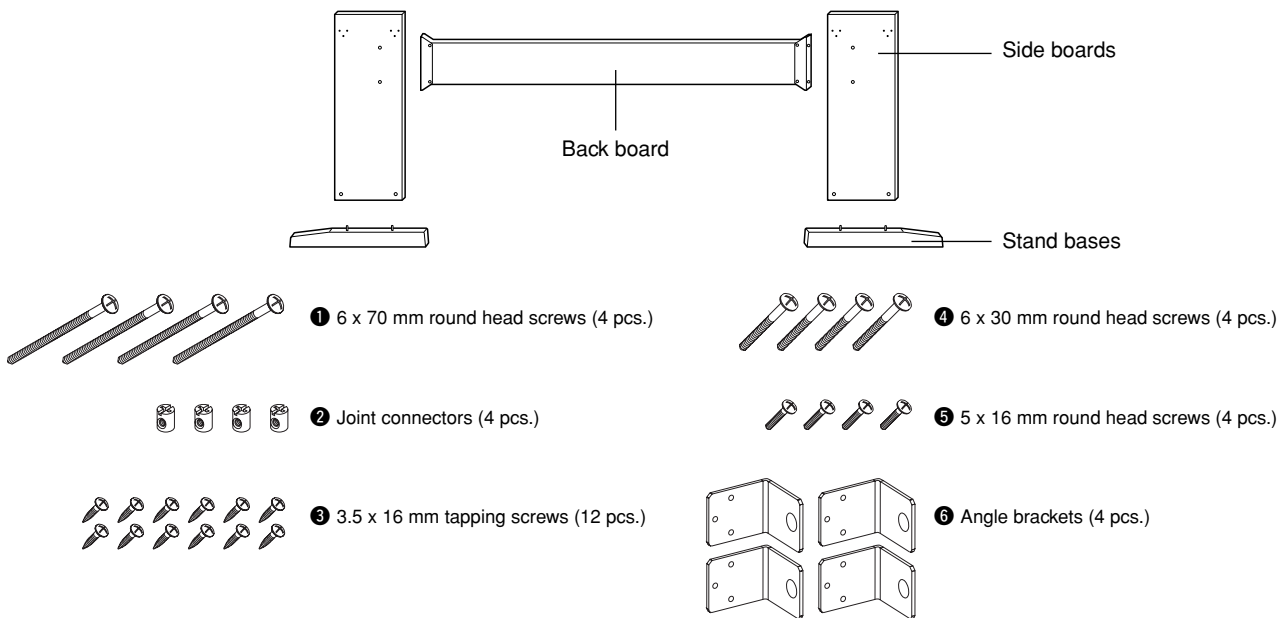

1

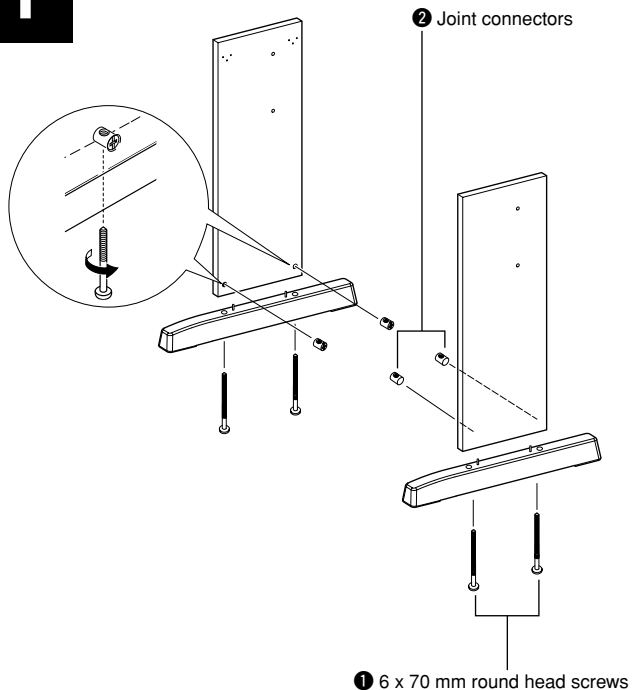

1 Attach the stand bases.

Making sure that the boards are facing the proper direction (the holes should face inside), insert the joint connectors 2 into the holes as shown. The joint connectors have been installed properly if you can see a plus mark on the connector.

Attach the stand bases to the rear of the side boards, using the 6 x 70 mm round head screws 1.

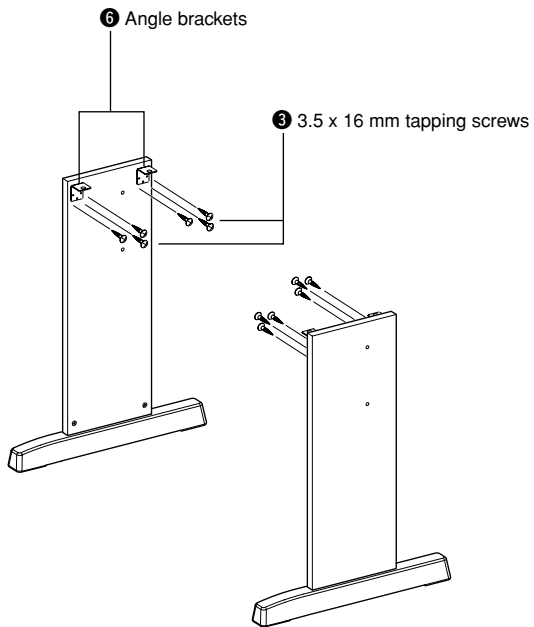
2**2 Attach the angle brackets.**

Attach the angle brackets **6** to the side boards using the 3.5 x 16 mm tapping screws **3**.

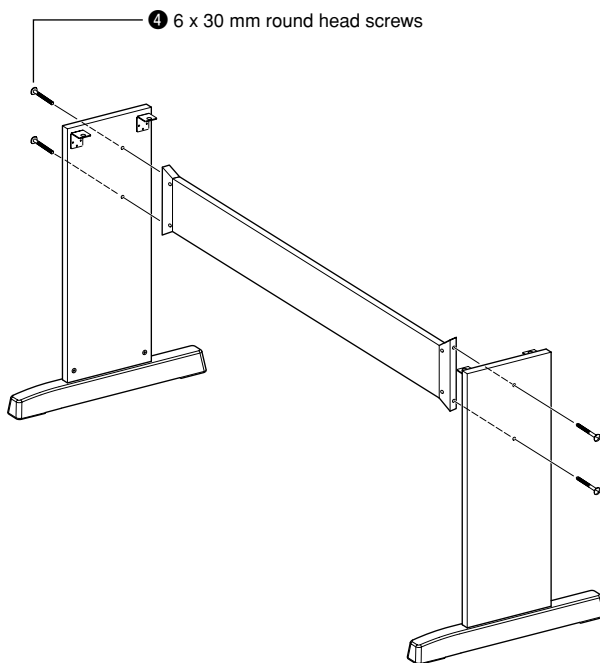
3**3 Attach the back board.**

Attach the back board, using the 6 x 30 mm round head screws **4**.

CAUTION

- *Be careful not to drop the back board or touch the sharp metal fittings.*

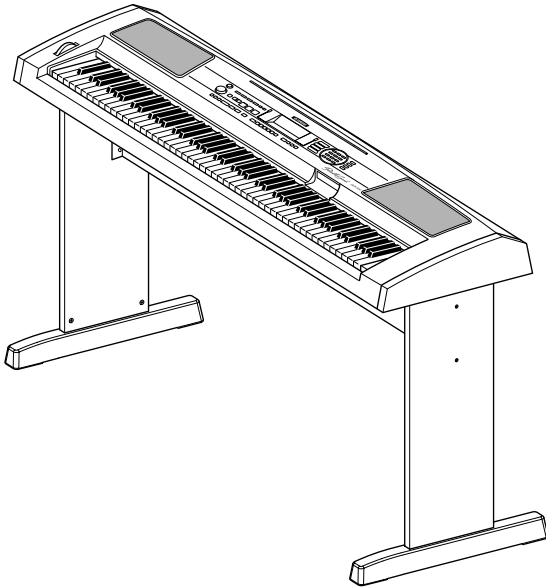
4**4 Put the keyboard on the stand.**

Carefully place the keyboard on the side boards.

Slowly move the keyboard so that the holes on the bottom of the keyboard are properly aligned with the holes on the angle brackets.

⚠ CAUTION

- *Be careful not to drop the keyboard or to get your fingers caught between the keyboard and the stand parts.*

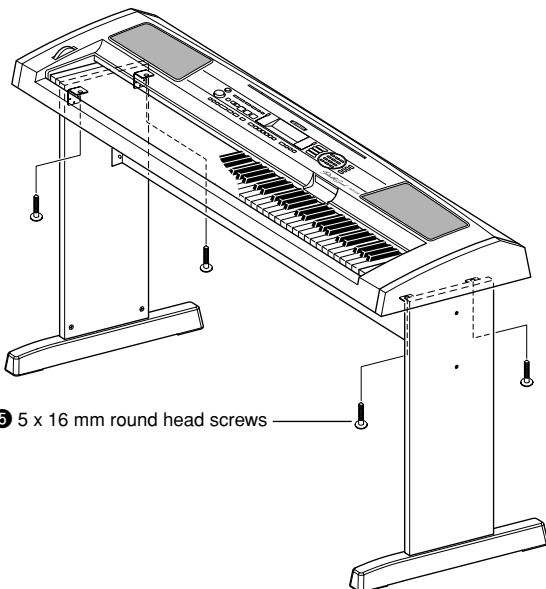
5**5 Install the keyboard to the stand.**

Fix the keyboard to the angle brackets, using the 5 x 16 mm round head screws **5**.

■ Post-assembly checklist

Once you've assembled the stand, check the following points:

- Are there any parts left over?
→ If so, read the assembly instructions again and correct any errors you might have made.
- Is the instrument clear of doors and other movable fixtures?
→ If not, move the instrument to an appropriate location.
- Does the instrument make a rattling noise when you play it or move it?
→ If so, properly tighten all screws.
- Also, if the keyboard makes a creaking noise or seems unsteady when you play it, refer carefully to the assembly instructions and diagrams and retighten all screws.



Specifications

Keyboards

- DGX-500.....88 standard-size keys (A-1 - C7), with Touch Response and Dynamic Filter.
- DGX-300.....76 standard-size keys (E0 - G6), with Touch Response and Dynamic Filter.

Display

- Large multi-function LCD display (backlit)

Setup

- STANDBY/ON
- MASTER VOLUME : MIN - MAX

Panel Controls

- OVERALL (L, R), SONG, VOICE, STYLE, M.D.B., PORTABLE GRAND, SPLIT, METRONOME, [0]-[9], [+](YES), [-](NO), DEMO, TOUCH, HARMONY, DUAL, DICTIONARY, L, R, TEMPO/TAP

Voice

- 122 panel voices + 12 drum kits + 480 XG voices + 5 DJ voices
- Polyphony : 32

STYLE

- 135 styles + Disk
- Accompaniment Control : ACMP, SYNC STOP, SYNC START, START/STOP, INTRO ENDING, MAIN/AUTO FILL
- Fingering : Multi fingering
- Accompaniment Volume

Music Database

- 208

Yamaha Educational Suite

- Dictionary
- Lesson 1-4

One Touch Setting

- Voice (for each style or song)

Overall controls

- | | |
|--|---|
| <ul style="list-style-type: none"> • Transpose • Accompaniment/Song Volume • Metronome Volume • PITCH BEND RANGE • Tuning • MIDI | <ul style="list-style-type: none"> • Harmony • Reverb • DSP • Grade • Lesson Track L/R • Track Octave |
|--|---|

Effects

- Reverb : 8 types
- DSP : 38 types
- Harmony : 26 types

Song

- 100 Songs + 5 User Songs
- Song Clear, Track Clear

Recording

- Song
User Song : 5 Songs
Recording Tracks : 1, 2, 3, 4, 5, Accompaniment

Disk

- Song Playback
- Save
- Load
- Delete
- Format

MIDI

- Initial Send
- Local on/off

Auxiliary jacks

- PHONES/OUTPUT, DC IN 12V, MIDI IN/OUT, FOOT SWITCH

Amplifier

- 6.0W + 6.0W

Speakers

- 12cm x 2 + 3cm x 2

Power Consumption

- UL / CSA : 19W
- CE : 18W
(when using PA-5D or PA-5C power adaptor)

Power Supply

- Adaptor : Yamaha PA-5D or PA-5C AC power adaptor
- Batteries : Six "D" size, R20P (LR20) or equivalent batteries

Dimensions (W x D x H)

- DGX-500 1,380 x 430 x 173 mm
(54-1/3" x 16-15/16" x 6-3/4")
- DGX-300 1,178 x 410 x 168 mm
(46-3/8" x 16-1/8" x 6-5/8")

Weight

- DGX-500 14 kg (30 lbs., 14 oz.)
DGX-500 Stand..... 7.6 kg (16 lbs., 12.)
- DGX-300 10 kg (22 lbs., 1 oz.)

Supplied Accessories

- DGX-500 Keyboard stand
Footswitch
Music Rest
Data Disk
Owner's Manual
Song Book
- DGX-300 Music Rest
Data Disk
Owner's Manual
Song Book

Optional Accessories

- DGX-500
 - Headphones : HPE-150
 - AC power adapter : PA-5D, PA-5C
- DGX-300
 - Headphones : HPE-150
 - AC power adapter : PA-5D, PA-5C
 - Footswitch : FC4, FC5
 - Keyboard stand : LG-100

* Specifications and descriptions in this owner's manual are for information purposes only. Yamaha Corp. reserves the right to change or modify products or specifications at any time without prior notice. Since specifications, equipment or options may not be the same in every locale, please check with your Yamaha dealer.



Index

Misc.

+/- buttons.....25

A

AC Power adaptor.....10
accessory jacks11
accompaniment sections.....45
Accompaniment Split Point.....49
Accompaniment Track.....63
Accompaniment Volume46
accompaniment, playing.....39
Auto Accompaniment.....38

B

Bank.....55
Batteries.....10
Beat display57
beat marks.....57

C

Chord Names.....52
Chord Type52
Chords, About.....51
Chords, Fingered47
Chords, Single Finger.....47
Clearing, Song65

D

DEMO button14
Demo songs14
Dictionary50
DISK ORCHESTRA.....73
DJ Voice List.....97
Drum Kit Voice Chart.....100
DSP.....34
DSP types36
Dual Voice DSP27
Dual Voice Octave27
Dual Voice Reverb27
Dual Voice Select.....27
Dual Voice Volume27

E

Effects33
Ending.....39
External clock.....88

F

Fill-in.....45
Fingered chords47
Footswitch11

G

GM System Level 1.....83
Grade72

H

Harmony35
HARMONY button.....35
Harmony types.....37
Headphones.....11

I

Indicator20
Initial Setup Send.....87
Initialization90
Intro.....41

K

Keyboard stand assembly
(DGX-500 only).....105

L

Lesson67

M

M.D.B. (music database)53
Main Voice DSP.....27
Main Voice Reverb.....27
Main Voice Volume27
Metronome.....22
MIDI83
MIDI channels84
MIDI Implementation Chart102
MIDI LSB Receive cancel88
MIDI terminals84
Multi Fingering.....47
MUSIC DATABASE.....53
Music Rest21

N

numeric keypad.....25

O

One Touch Setting.....28
Overall buttons.....20

P

PHONES/OUTPUT jack9
Pitch Bend.....31
Portable Grand22

Q

Quick Guide.....12

R

RECORD button62
recording, song.....62
Registration Memory55
Reverb.....33
Reverb types.....36
Root.....51

S

sections (accompaniment).....45
Single Finger chords47
Song Clear.....65
SONG MEMORY63
song recording.....62
Song Volume61
songs, recording62
songs, selecting and playing.....57
Specifications108
Split28
Split Point.....49
STYLE FILE.....73
styles, selecting38
SUSUTAIN11
Sync Start40
Sync Stop43

T

Tap.....40
Tempo (song).....60
Tempo (style).....44
Time Signature23
TOUCH button.....32
Touch Sensitivity.....32
track (song).....63
Track Octave76
tracks, muting.....63
Transpose29
Troubleshooting89
Tuning29

U

User songs62

V

Voice List.....91
voices, Drum Kit100
voices, selecting and playing.....24
voices, XG.....92

X

XG voices92

Limited Warranty

90 DAYS LABOR

1 YEAR PARTS

Yamaha Corporation of America, hereafter referred to as Yamaha, warrants to the original consumer of a product included in the categories listed below, that the product will be free of defects in materials and/or workmanship for the periods indicated. This warranty is applicable to all models included in the following series of products:

PortableGrand™ SERIES OF ELECTRONIC KEYBOARDS

If during the first 90 days that immediately follows the purchase date, your new Yamaha product covered by this warranty is found to have a defect in material and/or workmanship, Yamaha and/or its authorized representative will repair such defect without charge for parts or labor.

If parts should be required after this 90 day period but within the one year period that immediately follows the purchase date, Yamaha will, subject to the terms of this warranty, supply these parts without charge. However, charges for labor, and/or any miscellaneous expenses incurred are the consumers responsibility. Yamaha reserves the right to utilize reconditioned parts in repairing these products and/or to use reconditioned units as warranty replacements.

THIS WARRANTY IS THE ONLY EXPRESS WARRANTY WHICH YAMAHA MAKES IN CONNECTION WITH THESE PRODUCTS. ANY IMPLIED WARRANTY APPLICABLE TO THE PRODUCT, INCLUDING THE WARRANTY OF MERCHANT ABILITY IS LIMITED TO THE DURATION OF THE EXPRESS WARRANTY. YAMAHA EXCLUDES AND SHALL NOT BE LIABLE IN ANY EVENT FOR INCIDENTAL OR CONSEQUENTIAL DAMAGES.

Some states do not allow limitations that relate to implied warranties and/or the exclusion of incidental or consequential damages. Therefore, these limitations and exclusions may not apply to you.

This warranty gives you specific legal rights. You may also have other rights which vary from state to state.

CONSUMERS RESPONSIBILITIES

If warranty service should be required, it is necessary that the consumer assume certain responsibilities:

1. Contact the Customer Service Department of the retailer selling the product, or any retail outlet authorized by Yamaha to sell the product for assistance. You may also contact Yamaha directly at the address provided below.
2. Deliver the unit to be serviced under warranty to: the retailer selling the product, an authorized service center, or to Yamaha with an explanation of the problem. Please be prepared to provide proof purchase date (sales receipt, credit card copy, etc.) when requesting service and/or parts under warranty.
3. Shipping and/or insurance costs are the consumers responsibility.* Units shipped for service should be packed securely.

*Repaired units will be returned PREPAID if warranty service is required within the first 90 days.

IMPORTANT: Do NOT ship anything to ANY location without prior authorization. A Return Authorization (RA) will be issued that has a tracking number assigned that will expedite the servicing of your unit and provide a tracking system if needed.

4. Your owners manual contains important safety and operating instructions. It is your responsibility to be aware of the contents of this manual and to follow all safety precautions.

EXCLUSIONS

This warranty does not apply to units whose trade name, trademark, and/or ID numbers have been altered, defaced, exchanged removed, or to failures and/or damages that may occur as a result of:

1. Neglect, abuse, abnormal strain, modification or exposure to extremes in temperature or humidity.
2. Improper repair or maintenance by any person who is not a service representative of a retail outlet authorized by Yamaha to sell the product, an authorized service center, or an authorized service representative of Yamaha.
3. This warranty is applicable only to units sold by retailers authorized by Yamaha to sell these products in the U.S.A., the District of Columbia, and Puerto Rico. This warranty is not applicable in other possessions or territories of the U.S.A. or in any other country.

Please record the model and serial number of the product you have purchased in the spaces provided below.

Model _____ Serial # _____ Sales Slip # _____

Purchased from _____ Date _____
(Retailer)

YAMAHA CORPORATION OF AMERICA
Electronic Service Division
6600 Orangethorpe Avenue
Buena Park, CA 90620

KEEP THIS DOCUMENT FOR YOUR RECORDS. DO NOT MAIL!

For details of products, please contact your nearest Yamaha or the authorized distributor listed below.

Pour plus de détails sur les produits, veuillez-vous adresser à Yamaha ou au distributeur le plus proche de vous figurant dans la liste suivante.

Die Einzelheiten zu Produkten sind bei Ihrer unten aufgeführten Niederlassung und bei Yamaha Vertragshändlern in den jeweiligen Bestimmungsländern erhältlich.

Para detalles sobre productos, contacte su tienda Yamaha más cercana o el distribuidor autorizado que se lista debajo.

NORTH AMERICA

CANADA

Yamaha Canada Music Ltd.
135 Milner Avenue, Scarborough, Ontario,
M1S 3R1, Canada
Tel: 416-298-1311

U.S.A.

Yamaha Corporation of America
6600 Orangethorpe Ave., Buena Park, Calif. 90620,
U.S.A.
Tel: 714-522-9011

CENTRAL & SOUTH AMERICA

MEXICO

**Yamaha de Mexico S.A. De C.V.,
Departamento de ventas**
Javier Rojo Gomez No.1149, Col. Gpe Del
Moral, Deleg. Iztapalapa, 09300 Mexico, D.F.
Tel: 686-00-33

BRAZIL

Yamaha Musical do Brasil LTDA.
Av. Rebouças 2636, São Paulo, Brasil
Tel: 011-853-1377

ARGENTINA

Yamaha de Panamá S.A. Sucursal de Argentina
Viamonte 1145 Piso2-B 1053,
Buenos Aires, Argentina
Tel: 1-4371-7021

PANAMA AND OTHER LATIN AMERICAN COUNTRIES/ CARIBBEAN COUNTRIES

Yamaha de Panamá S.A.
Torre Banco General, Piso 7, Urbanización Marbella,
Calle 47 y Aquilino de la Guardia,
Ciudad de Panamá, Panamá
Tel: 507-269-5311

EUROPE

THE UNITED KINGDOM

Yamaha-Kemble Music (U.K.) Ltd.
Sherbourne Drive, Tilbrook, Milton Keynes,
MK7 8BL, England
Tel: 01908-366700

IRELAND

Danfay Ltd.
61D, Sallynoggin Road, Dun Laoghaire, Co. Dublin
Tel: 01-2859177

GERMANY/SWITZERLAND

Yamaha Europa GmbH.
Siemensstraße 22-34, 25462 Rellingen,
F.R. of Germany
Tel: 04101-3030

AUSTRIA

Yamaha Music Austria
Schleiergasse 20, A-1100 Wien Austria
Tel: 01-60203900

THE NETHERLANDS

Yamaha Music Nederland
Kanaalweg 18G, 3526KL, Utrecht, The Netherlands
Tel: 030-2828411

BELGIUM

Yamaha Music Belgium
Keilberg Imperiastraat 8, 1930 Zaventem, Belgium
Tel: 02-7258220

FRANCE

**Yamaha Musique France,
Division Claviers**
BP 70-77312 Marne-la-Vallée Cedex 2, France
Tel: 01-64-61-4000

ITALY

Yamaha Musica Italia S.P.A.
Viale Italia 88, 20020 Lainate (Milano), Italy
Tel: 02-935-771

SPAIN/PORTUGAL

Yamaha-Hazen Electronica Musical, S.A.
Ctra. de la Coruna km. 17, 200, 28230
Las Rozas (Madrid) Spain
Tel: 91-201-0700

GREECE

Philippe Nakas S.A.
Navarinou Street 13, P.Code 10680, Athens, Greece
Tel: 01-364-7111

SWEDEN

Yamaha Scandinavia AB
J. A. Wettergrens Gata 1
Box 30053
S-400 43 Göteborg, Sweden
Tel: 031 89 34 00

DENMARK

YS Copenhagen Liaison Office
Generatorvej 8B
DK-2730 Herlev, Denmark
Tel: 44 92 49 00

FINLAND

F-Musiikki Oy
Kluuvikatu 6, P.O. Box 260,
SF-00101 Helsinki, Finland
Tel: 09 618511

NORWAY

Norsk filial av Yamaha Scandinavia AB
Grini Næringspark 1
N-1345 Østerås, Norway
Tel: 67 16 77 70

ICELAND

Skeifan HF
Skeifan 17 P.O. Box 8120
IS-128 Reykjavik, Iceland
Tel: 525 5000

OTHER EUROPEAN COUNTRIES

Yamaha Europa GmbH.
Siemensstraße 22-34, 25462 Rellingen,
F.R. of Germany
Tel: 04101-3030

AFRICA

**Yamaha Corporation,
Asia-Pacific Music Marketing Group**
Nakazawa-cho 10-1, Hamamatsu, Japan 430-8650
Tel: 053-460-2312

MIDDLE EAST

TURKEY/CYPRUS

Yamaha Europa GmbH.
Siemensstraße 22-34, 25462 Rellingen,
F.R. of Germany
Tel: 04101-3030

OTHER COUNTRIES

Yamaha Music Gulf FZE
LB21-128 Jebel Ali Freezone
P.O.Box 17328, Dubai, U.A.E.
Tel: 971-4-881-5868

ASIA

HONG KONG

Tom Lee Music Co., Ltd.
11/F., Silvercord Tower 1, 30 Canton Road,
Tsimshatsui, Kowloon, Hong Kong
Tel: 2737-7688

INDONESIA

**PT. Yamaha Music Indonesia (Distributor)
PT. Nusantara**
Gedung Yamaha Music Center, Jalan Jend. Gatot
Subroto Kav. 4, Jakarta 12930, Indonesia
Tel: 21-520-2577

KOREA

Yamaha Music Korea Ltd.
Tong-Yang Securities Bldg. 16F 23-8 Yoido-dong,
Youngdungpo-ku, Seoul, Korea
Tel: 02-3770-0661

MALAYSIA

Yamaha Music Malaysia, Sdn., Bhd.
Lot 8, Jalan Perbandaran, 47301 Kelana Jaya,
Petaling Jaya, Selangor, Malaysia
Tel: 3-703-0900

PHILIPPINES

Yupangco Music Corporation
339 Gil J. Puyat Avenue, P.O. Box 885 MCPO,
Makati, Metro Manila, Philippines
Tel: 819-7551

SINGAPORE

Yamaha Music Asia Pte., Ltd.
11 Ubi Road #06-00, Meiban Industrial Building,
Singapore
Tel: 65-747-4374

TAIWAN

Yamaha KHS Music Co., Ltd.
10F, 150, Tun-Hwa Northroad,
Taipei, Taiwan, R.O.C.
Tel: 02-2713-8999

THAILAND

Siam Music Yamaha Co., Ltd.
121/60-61 RS Tower 17th Floor,
Ratchadaphisek RD., Dindaeng,
Bangkok 10320, Thailand
Tel: 02-641-2951

THE PEOPLE'S REPUBLIC OF CHINA AND OTHER ASIAN COUNTRIES

**Yamaha Corporation,
Asia-Pacific Music Marketing Group**
Nakazawa-cho 10-1, Hamamatsu, Japan 430-8650
Tel: 053-460-2317

OCEANIA

AUSTRALIA

Yamaha Music Australia Pty. Ltd.
Level 1, 99 Queensbridge Street, Southbank, Victoria
3006, Australia
Tel: 3-9693-5111

NEW ZEALAND

Music Houses of N.Z. Ltd.
146/148 Captain Springs Road, Te Papapa,
Auckland, New Zealand
Tel: 9-634-0099

COUNTRIES AND TRUST TERRITORIES IN PACIFIC OCEAN

**Yamaha Corporation,
Asia-Pacific Music Marketing Group**
Nakazawa-cho 10-1, Hamamatsu, Japan 430-8650
Tel: 053-460-2312

HEAD OFFICE Yamaha Corporation, Pro Audio & Digital Musical Instrument Division
Nakazawa-cho 10-1, Hamamatsu, Japan 430-8650
Tel: 053-460-3273



Yamaha PK CLUB (Portable Keyboard Home Page, English only)

<http://www.yamahaPKclub.com/>

Yamaha Manual Library

<http://www2.yamaha.co.jp/manual/english/>

M.D.G., Pro Audio & Digital Musical Instrument Division, Yamaha Corporation
© 2002 Yamaha Corporation

V880030 ???PO???.?-01A0 Printed in China