

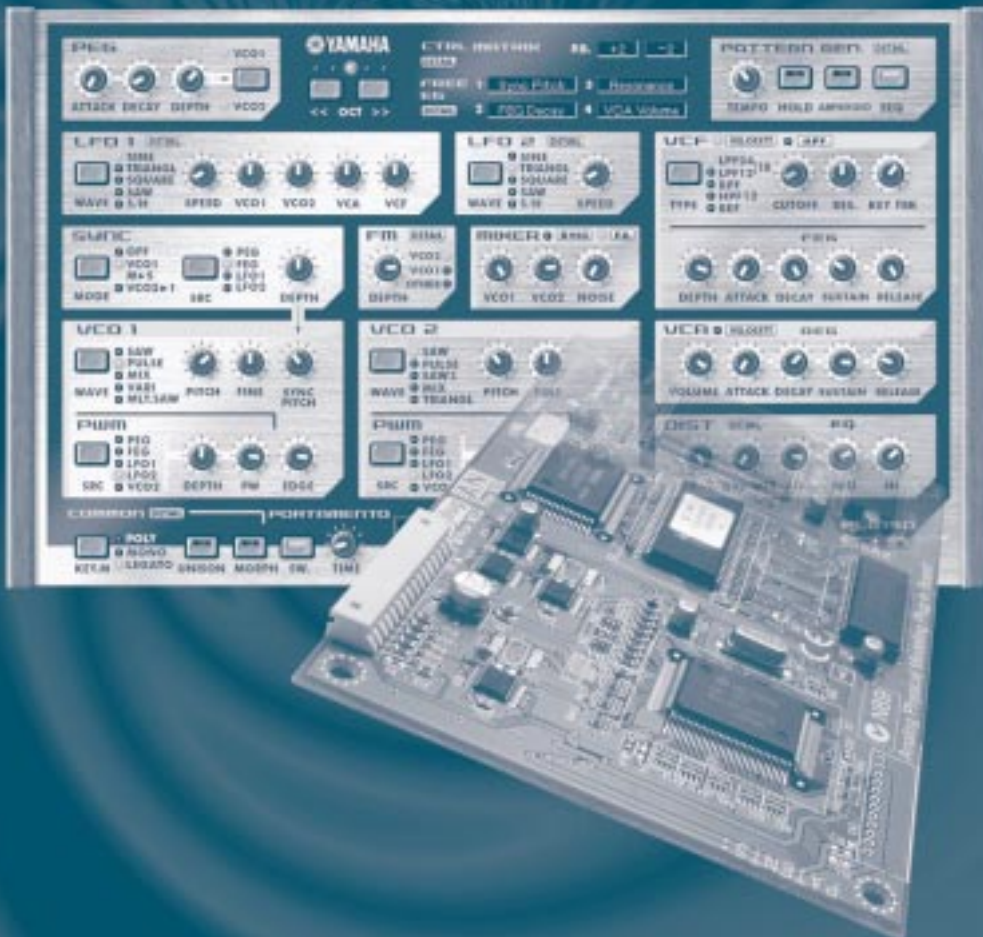

Analog Physical Modeling Plug-in Board
Analog Physical Modeling Plug-in Board
Carte Plug-in de Synthèse à Modélisation Analogique

PLG150-AN

Owner's Manual
Bedienungsanleitung
Mode d'emploi



English

Deutsch

Français

**MODULAR SYNTHESIS
PLUG-IN SYSTEM**



Precautions

- Do not expose the plug-in board to direct sunlight, excessive humidity, high temperatures, excessive dust or strong vibrations.
- Before handling the plug-in board, be sure to touch a metal surface to discharge any static electricity which may be in your body.
- When holding the plug-in board, do not touch the inside area of the circuit board or apply excessive pressure to the board, and be sure to protect the board from contact with water or other liquids.
- Before installing the plug-in board onto a tone generator/sound card, unplug the power connector of your computer.
- Before connecting the computer to other devices, turn off the power switches of all devices.
- Yamaha is not responsible for loss of data through computer malfunctions or operator actions.
- The plug-in board contains no user-serviceable parts, so never touch the inside area of the circuit board or tamper with the electronic circuitry in any way. Doing so may result in electrical shock or damage to the plug-in board.

YAMAHA CANNOT BE HELD RESPONSIBLE FOR DAMAGE CAUSED BY IMPROPER CARE AND USE OF THE PLUG-IN BOARD.

* The company names and product names in this Owner's Manual are the trademarks or registered trademarks of their respective companies.

* The screens as illustrated in this owner's manual are for instructional purposes only, and may appear somewhat different from the ones of your instrument.

FCC INFORMATION (U.S.A.)

1. IMPORTANT NOTICE: DO NOT MODIFY THIS UNIT!

This product, when installed as indicated in the instructions contained in this manual, meets FCC requirements. Modifications not expressly approved by Yamaha may void your authority, granted by the FCC, to use the product.

2. **IMPORTANT:** When connecting this product to accessories and/or another product use only high quality shielded cables. Cable/s supplied with this product **MUST** be used. Follow all installation instructions. Failure to follow instructions could void your FCC authorization to use this product in the USA.

3. **NOTE:** This product has been tested and found to comply with the requirements listed in FCC Regulations, Part 15 for Class "B" digital devices. Compliance with these requirements provides a reasonable level of assurance that your use of this product in a residential environment will not result in harmful interference with other electronic devices. This equipment generates/uses radio frequencies and, if not installed and used according to the instructions found in the users manual, may cause interference harmful to the operation of other electronic devices. Compliance with FCC regulations does not guarantee that interference will not occur in all installations. If this product is found to be the source of interference, which can be determined by turning the unit "OFF" and "ON", please try to eliminate the problem by using one of the following measures:

Relocate either this product or the device that is being affected by the interference.

Utilize power outlets that are on different branch (circuit breaker or fuse) circuits or install AC line filter/s.

In the case of radio or TV interference, relocate/reorient the antenna. If the antenna lead-in is 300 ohm ribbon lead, change the lead-in to co-axial type cable.

If these corrective measures do not produce satisfactory results, please contact the local retailer authorized to distribute this type of product. If you can not locate the appropriate, please contact Yamaha Corporation of America, Electronic Service Division, 6600 Orangethorpe Ave, Buena Park, CA 90620

* This applies only to products distributed by YAMAHA CORPORATION OF AMERICA.

CANADA

This Class B digital apparatus complies with Canadian ICES-003.

Cet appareil numérique de la classe B est conforme à la norme NMB-003 du Canada.

- This applies only to products distributed by Yamaha Canada Music Ltd.
- Ceci ne s'applique qu'aux produits distribués par Yamaha Canada Musique Ltée.

Congratulations and thank you for purchasing the Yamaha PLG150-AN Control Synthesizer Plug-in Board!

The PLG150-AN is a custom tone generator designed for use with a variety of Yamaha electronic musical instruments. Foremost, the PLG150-AN can be installed to and integrated with instruments of the Modular Synthesis Plug-in System (such as the CS6x, CS6R, S80, etc.) It can also be used seamlessly with the MU128 Tone Generator (as well as other MU-series instruments and the SW1000XG PCI Audio/MIDI Board). The PLG150-AN employs Analog Physical Modeling synthesis, for faithful reproduction of analog synthesizer sounds. It not only features the same familiar oscillator, filter and other sound creation elements on traditional analog synthesizers — it gives you the full spectrum of warm, fat, and punchy sounds that made those legendary instruments famous.

The settings and parameters of the PLG150-AN can also be conveniently edited with a Windows PC computer by using the AN Easy Editor and AN Expert Editor software modules (included in the XGworks Music Sequencer software).

Table of Contents

Overview of the PLG150-AN	4	Selecting AN Voices (Modular Synthesis Plug-in System)	20
Analog Physical Modeling Synthesis and the PLG150-AN Tone Generator	6	Enabling and Selecting AN Voices.....	20
PLG150-AN Tone Generator Block Diagram.....	7	Editing the AN Native Part Parameters (Modular Synthesis Plug-in System)	21
VCO.....	7	Selecting/Editing the AN System Parameters (Modular Synthesis Plug-in System)	22
Noise, Ring Modulator and Feedback.....	10	Selecting AN Voices (XG Plug-in System)	23
VCF.....	11	Enabling and Selecting AN Voices.....	23
VCA.....	11	Editing the AN Native Part Parameters (XG Plug-in System)	25
LFO 1, 2 and PEG, FEG.....	12	Selecting/Editing the AN System Parameters (XG Plug-in System)	27
Effects.....	12	Parameters	28
Memory Buffer Structure	13	AN Native Part Parameters.....	28
Specifications	14	AN System Parameters.....	34
About the Included Floppy Disks	14	Appendix	38
Installing the PLG150-AN	16	Voice List	38
Included Items	16	Tone Generator And Effect Signal Flow	47
Required and Recommended Items	16	Arpeggio Type List	48
Synthesizer/Tone Generator/ Sound Card Compatible with the Modular Synthesis or XG Plug-in Systems.....	16	Control Matrix & Free EG Track Parameter List	49
XGworks or XGworks lite Music Sequencing Software.....	17	Parameter List (XG / Modular Synthesis Plug-in System)	50
AN Easy Editor.....	17	MIDI Data Format	51
AN Expert Editor.....	17	MIDI Implementation Chart	70
Installing and Starting the Plug-in Editor Software (Windows 95/98)	18		
Installing the Software.....	18		
Starting the AN Easy Editor.....	18		
Starting the AN Expert Editor.....	19		

Overview of the PLG150-AN

The PLG150-AN gives you a full-featured, powerful synthesizer with stunning analog-like sound — thanks to the Analog Physical Modeling system — in a compact plug-in board. In addition to being packed with standard synthesizer “modules” (including VCO, VCF and VCA) that provide comprehensive, flexible control over the sound, the PLG150-AN also features a built-in Arpeggio and Step Sequencer for generating and playing back complex patterns at the touch of a key.

■ Easy Installation

Once it is connected, the PLG150-AN automatically becomes another sound source in the tone generator/sound card, and can be used as one of the instrument Parts. You can create your own original AN voices and combine AN voices with the other voices in the “mother” device.

■ 256 Voices and Five-note Polyphony

The PLG150-AN is packed with a total of 256 dynamic and powerful voices, each of which can be changed temporarily, using the Part Edit parameters, or edited (using the AN Expert Editor software) to create your own original voices. With the five notes of polyphony, you can play the rich sounds with full-handed chords, or use the Unison mode to create huge, fat monophonic sounds.

■ Comprehensive Editing Functions

Naturally, the AN voices can be processed and edited in the same way as the normal voices of the tone generator/sound card. Moreover, once you’ve equipped your tone generator with the PLG150-AN board, a special set of AN parameters become automatically available — letting you edit and change the sounds as desired. And for further editing convenience and power, the included AN Easy Editor and AN Expert Editor software let you change all parameters from a computer.

■ Super Fat Unison Sound

The PLG150-AN gives you all the sonic power and punch of vintage analog synthesizers with the Unison feature. This slightly detunes each of the five available sound elements in a voice, and gangs them together to create one huge, fat monophonic sound.

■ Powerful “Morphing” Control

This exceptionally powerful function allows you to use any MIDI controller (such as a modulation wheel, foot controller, or after touch) to “morph” or crossfade between two distinct voices — in real time as you play! Naturally, you can record controller data to a sequencer for automated morphing within a song as well. This lets you create dramatic or subtle sonic changes in your performance or song.

■ Pattern Generator with Arpeggio and Step Sequencer

These features let you automatically produce a wide variety of note patterns in real time as you perform. Arpeggio lets you play perfect arpeggiated chords at the simple press of a key. The Step Sequencer permits quick, easy creation of highly sophisticated looped patterns which can be triggered from the keyboard in a variety of ways. Both of these can be edited in detail with the AN Expert Editor software in XGworks (page 17).

■ Four-track Free EG

The four-track Free EG lets you program changes to four independent parameters — such as filter, resonance, LFO and many others — and have the changes play back automatically by simply playing a voice, and even have the tempo of the changes sync to MIDI clock. The Free EG can be edited in detail with the AN Expert Editor software in XGworks (page 17).

MODULAR SYNTHESIS PLUG-IN SYSTEM

About the Modular Synthesis Plug-in System

The Yamaha Modular Synthesis Plug-in System offers powerful expansion and upgrade capabilities for Modular Synthesis-Plug-in-compatible synthesizers, tone generators and sound cards. This enables you to easily and effectively take advantage of the latest and most sophisticated synthesizer and effects technology, allowing you to keep pace with the rapid and multi-faceted advances in modern music production.



About the XG Plug-in System

The Yamaha XG Plug-in System offers powerful expansion and upgrade capabilities for XG-Plug-in-compatible tone generators and sound cards. This enables you to easily and effectively take advantage of the latest and most sophisticated synthesizer and effects technology, allowing you to keep pace with the rapid and multi-faceted advances in modern music production.



About AN-XG

The AN Extension for XG (abbreviated as “AN-XG”) built-into the PLG150-AN significantly enhances and expands the musical capabilities of the XG format with the rich analog-style sounds and comprehensive control features of the Analog Physical Modeling synthesis system. The PLG150-AN incorporates all the versatile functions of the AN1x Control Synthesizer — including multiple oscillators, filters, Morphing, Free EG, and a Pattern Generator with Arpeggio and Step Sequencer — into an XG tone generator/sound card.

Analog Physical Modeling Synthesis and the PLG150-AN Tone Generator

As the PLG150-AN Tone Generator Block Diagram (page 7) illustrates, the VCO module generates the basic signal, then passes it along the signal path to the MIXER and VCF modules, processing the signal in a variety of ways before passing it on to the VCA module, which controls the volume of the signal — before passing it along to be processed (by Distortion and 3-BandEQ) along with the other Parts of the tone generator. Along the way, various real-time and other controllers can be applied to each module in a variety of ways, providing enormous sound-shaping and sound-creating possibilities.



Some of the parameters mentioned in the following explanations cannot be accessed from the “mother” device; however, they can be controlled with the special AN Easy Editor and AN Expert Editor plug-in software modules (used in XGworks or XGworks lite). Even without the use of the plug-in software, the original AN voices of the PLG150-AN provide enormous sonic complexity and flexibility, especially with the use of the Part parameters and the AN Assignable Controllers on the “mother” device.

Oscillators, Filters And Amplifiers

What does it take to make a sound? And how does the PLG150-AN generate sounds?

In the simplest of terms, there are three basic elements which make up a sound: pitch, or how low or high it is; tone, or what its overall quality, or timbre is like; and amplitude, or how loud the volume level is.

Synthesizers rely on three key electronic components to generate sounds and electronically imitate the soundwaves of familiar musical instruments, as well as create entirely unique sounds. In traditional analog synthesis, the source sound pitch and waveform is generated by an oscillator; its tone is controlled by a filter; and its volume is determined by an amplifier. With the PLG150-AN, these three elements are termed the VCO (voltage controlled oscillator), the VCF (voltage controlled filter), and the VCA (voltage controlled amplifier).

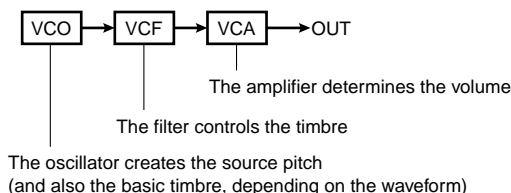

The “signal path” starts at the VCO, flows to the VCF, then flows to the VCA. The signal is “processed” at each block, or “module” along the way to the final output.

PLG150-AN Tone Generator Block Diagram

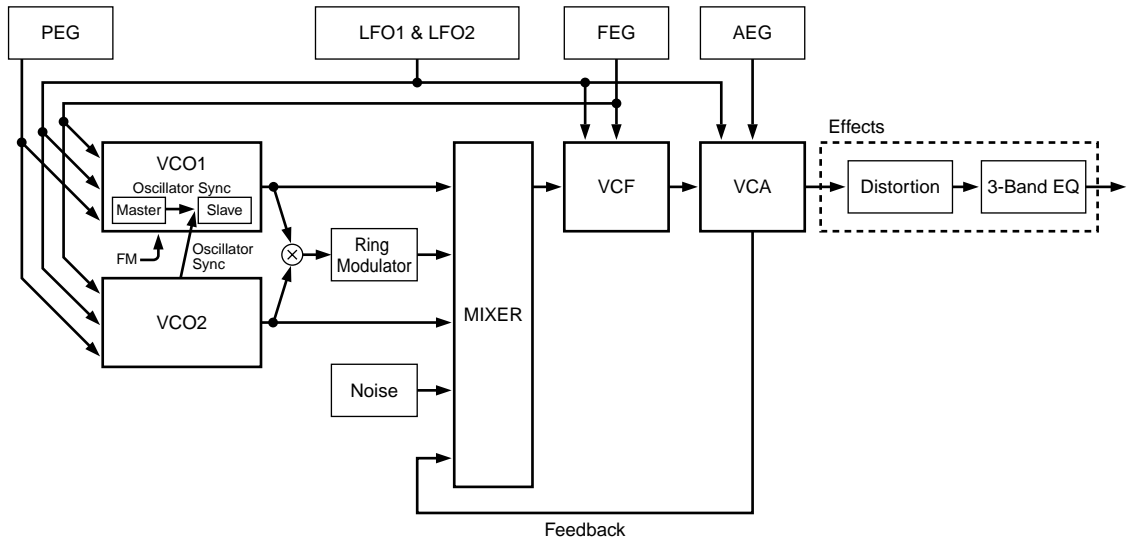

VCO

The VCO module is where the original sound waveform is generated. In general, the VCOs of analog synthesizers feature the simple waveforms shown below.

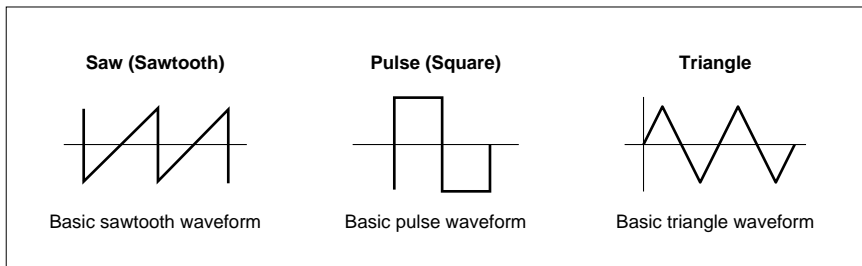

In theory, these waveforms are very simple; in the real world, they're not so simple. Because of the characteristics of electronic circuits, all analog synthesizers introduce subtle imperfections into the waveform. These imperfections result in slightly rounding off the edges of the wave, or adding noise, and other artifacts — and they give each synthesizer its own special, unique sound.

Although a single oscillator is enough to generate the basic sawtooth, pulse (square) or other waves required for different types of musical instrument sounds, the PLG150-AN's VCO module provides far greater flexibility. The PLG150-AN's digital VCO creates mathematically exact waveforms.

However, the instrument also gives you a wide variety of tools (including Pulse Width Modulation and Edge) for introducing analog-like “imperfections” to the waveforms and making them much more complex and interesting.

The VCO of the PLG150-AN actually has two blocks: VCO 1 and VCO 2. With VCO 1, you can select a variety of waves, and it can be configured with one of three “sync modes” that syncs “master” and “slave” oscillators within the VCO 1. Thus, when the sync is on, the VCO 1 is actually two oscillators in one, and additional waves are available.

The VCO 1 is always fixed as the FM carrier, but the carrier can either be the master or slave oscillator depending on the selected algorithm, when Sync mode is set to on. The FM modulator can be selected from VCO2, the PEG, FEG, LFO1, LFO2 or others. The Pitch Envelope Generator (PEG) lets you determine how the pitch of the VCO changes over time, and the LFO can be used to modulate the VCO to create vibrato.

The PLG150-AN also has a second oscillator section: VCO 2. VCO 2 has many of the same waves and controls as does VCO 1, but differs slightly in the waves that are available. For certain waves, it also features special cross-modulation that generates complex harmonics by modulating the frequency of the oscillator. The VCO 2 can also be set (with the Sync parameter) to modulate the VCO 1.

■ Pulse Width and Pulse Width Modulation

In conventional analog synthesizers, pulse width (PW) is used to change the shape of a pulse waveform. This changes the harmonics or overtones (which determine the timbre or tone) of the sound. Pulse width modulation (PWM) uses an LFO to periodically change the width, and hence, the harmonics.

The PLG150-AN lets you control not only the Pulse wave in this way, but also Saw and Mix (a combination of Saw and Pulse). In addition to using an LFO to modulate the Pulse Width, the PLG150-AN lets you create a “fat” chorus-like effect, depending on the parameter settings.

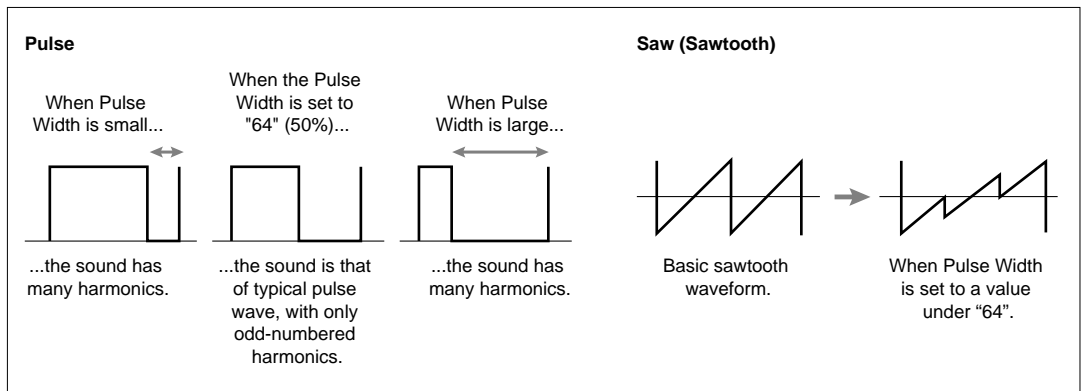

■ Edge

This useful parameter lets you make fine, subtle changes to the waveform. Higher Edge values produce a sharper waveform, resulting in a harder, harsher sound with many harmonics. Reducing the value makes the waveform rounder, producing a softer, warmer sound. (At the minimum value, this actually results in a sine wave.)

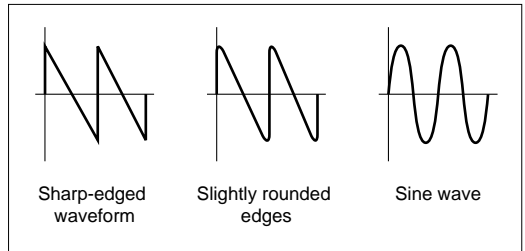

■ Oscillator Sync

Oscillator Sync is another common function in analog synthesis that synchronizes one oscillator's waveform with that of another oscillator.

In the illustration below, the waveform of oscillator 1 is constantly reset so that it starts its wave cycle at the same phase point (the first position of the wave cycle) as oscillator 2. As a result, the waveform of oscillator 1 becomes more complex than normal, adding harmonics to the sound. (In the illustration below, the sound of oscillator 1 becomes brighter than what it would be originally.)

Here, oscillator 1 is referred to as the “slave” oscillator, while oscillator 2 is called the “master.” Changing the pitch of the master oscillator changes the pitch of the overall sound. On the other hand, changing the pitch of the slave oscillator changes the timbre or tone of the overall sound by altering the amount of harmonics.

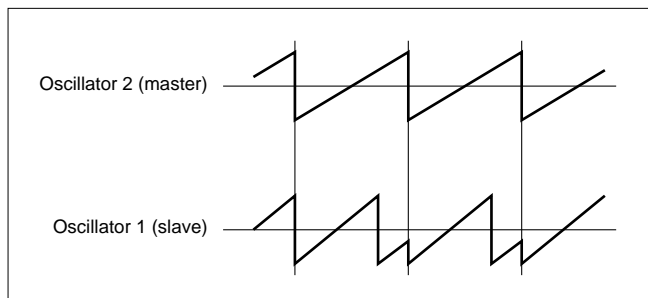

Just as with conventional analog synthesizers, the PLG150-AN allows you to synchronize the oscillators of VCO 1 and VCO 2. What's more, it allows you to use Oscillator Sync with only VCO 1, since VCO 1 actually has two oscillators by itself.

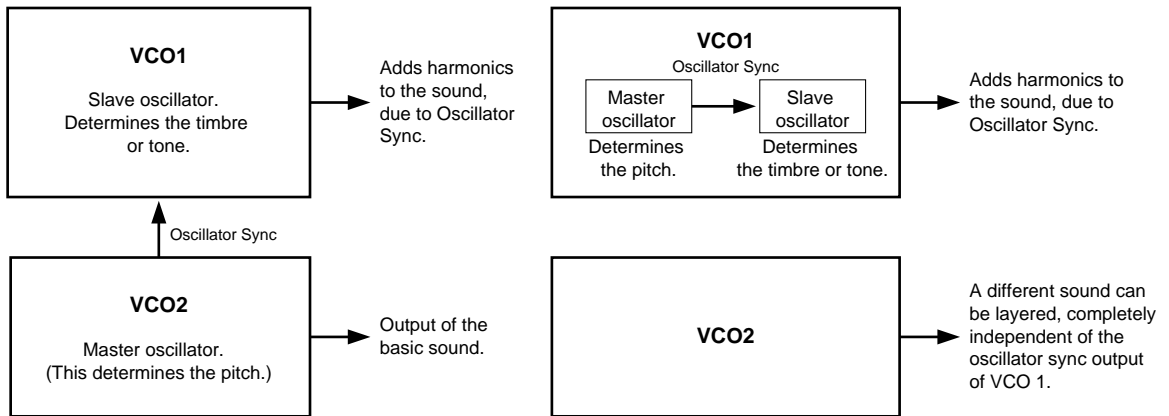

Using Oscillator Sync to lock VCO 1 to VCO 2

This method is the same as on conventional analog synthesizers. The sound quality can be changed by giving VCO 1 and VCO 2 different pitches.

Using Oscillator Sync within VCO 1

This method is unique to the PLG150-AN. Since VCO 1 and VCO 2 are independent, you can still use Oscillator Sync to get more harmonics, yet layer VCO 1 and VCO 2 to produce sound of even greater complexity and richness.

■ FM

FM uses the wave of one oscillator (called the “modulator”) to periodically change the pitch or frequency of another oscillator (called the “carrier”).

The FM generated sound is output by the carrier, and the type and amount of harmonics that are added to the sound differs depending on the ratio of the modulator and carrier frequencies.

On the PLG150-AN, the following can be used as the modulator: VCO 2, LFO, and each EG. The carrier is fixed to VCO 1.

Noise, Ring Modulator and Feedback

In addition to the VCO 1 and VCO 2 oscillators, the PLG150-AN includes a Noise oscillator, plus Ring Modulator and Feedback controls. The levels of these five sound sources can be freely mixed, giving you a wide range of sonic possibilities and comprehensive sound shaping control.



Avoid making drastic changes to Feedback, or setting the Feedback level to values at or near the maximum. Doing so could damage your speakers (and your ears!). If you hear any strange or unusual vibrations in your speakers as you are adjusting the Feedback level, immediately turn Feedback down.

VCF

Once the VCO 1, VCO 2, Ring Modulator, Noise and Feedback signals are mixed in the MIXER module, they can then be filtered by the VCF module. The VCF includes a comprehensive set of filters, including Low Pass Filter (LPF), High Pass Filter (HPF), Band Pass Filter (BPF) and Band Eliminate Filter (BEF). You can determine the Cutoff frequency of the VCF, as well as amount of Resonance, or emphasis around the frequency cutoff point. Resonance and Cutoff actually work interdependently with each other, and their overall effect depends also on the voice selected. On the PLG150-AN, you can adjust the Cutoff frequency over an exceptionally wide range. Also, high values for Resonance create a relatively warm analog-like quality.

The Filter Envelope Generator (FEG) lets you determine how the timbre of the signal changes over time, and the LFO1 or LFO2 can be used to modulate the VCF to create wah.

The FEG features four parameters:

- Attack Time
- Decay Time
- Sustain Level
- Release Time

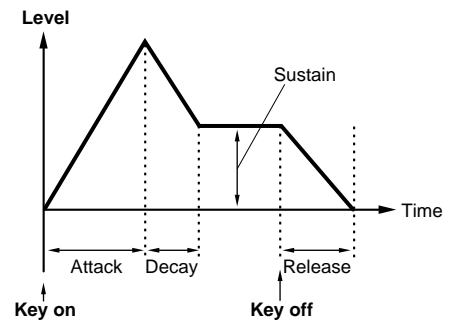

VCA

The VCA module is where the overall output level of the signal is determined. The Amplitude Envelope Generator (AEG) lets you determine how the volume of the signal changes over time, and the LFO1 or LFO2 can be used to modulate the VCA to create tremolo.

The AEG features four parameters:

- Attack Time
- Decay Time
- Sustain Level
- Release Time

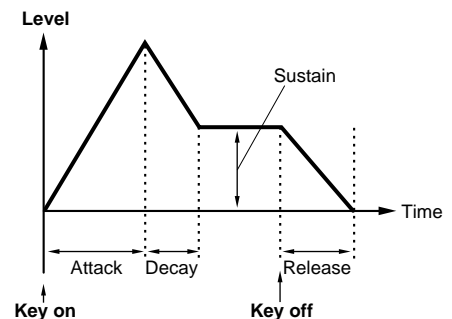

LFO 1, 2 and PEG, FEG

The LFO 1 and LFO 2 sections provide a sophisticated set of modulation possibilities, allowing you to modulate the VCO 1, VCO 2, VCA, and VCF sections in various ways and degrees.

The LFO can be used to control:

Pmod (pitch of the oscillator)	PWM (Pulse Width Modulation)
Fmod (Cutoff frequency of the filter)	Sync Pitch (pitch of the slave oscillator)
Amod (depth of the amplifier, or volume)	FM Depth

This gives you enormous flexibility in controlling and shaping the sound.

The PEG (Pitch EG) section lets you control the pitch of the VCO 1 and/or VCO 2 over time, with a conventional envelope generator. The FEG (Filter EG) gives you similar control over how the filter affects the sound over time. On the PLG150-AN, the PEG and FEG give you additional modulation control sources, providing the comprehensive and flexible control as found on vintage analog synthesizers — yet without the expense of additional modules and the complexity of dozens of patch cords.

Example

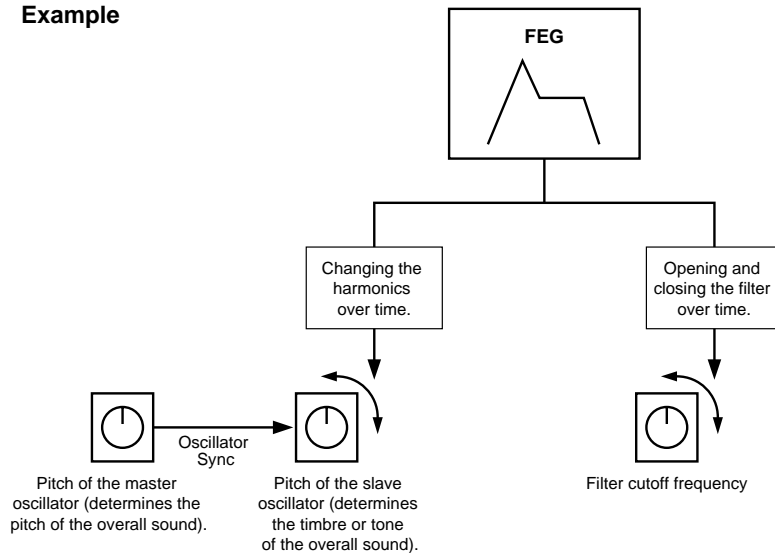

Effects

The PLG150-AN also features an Effects section that includes Distortion and 3-Band EQ. These effects give you further sonic control over the AN voice, letting you apply and adjust distortion, and make detailed equalization settings.

Memory Buffer Structure

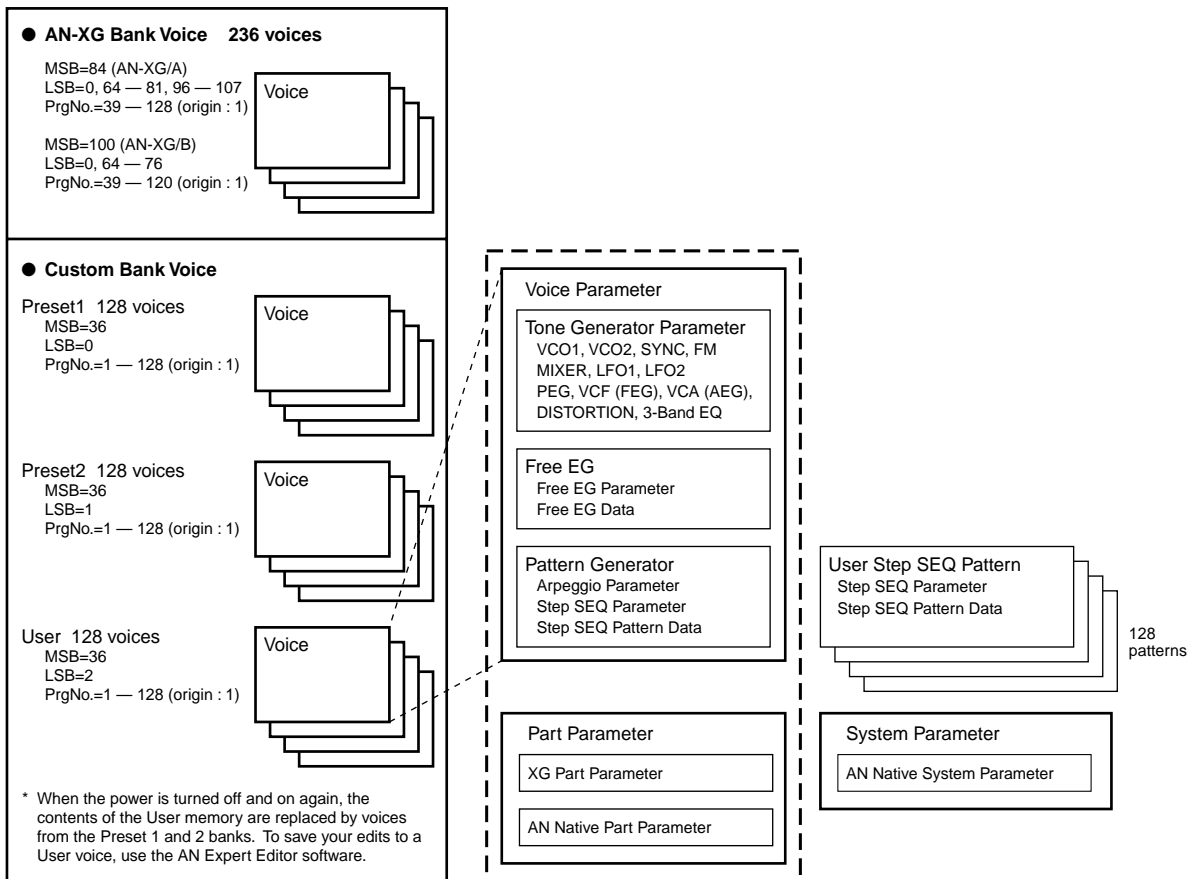

Specifications

TONE GENERATOR/MODULES :

Analog Physical Modeling, 2VCO(OSCILLATOR & FM), Ring Modulator, Noise, VCF(FEG), VCA(AEG), PEG, 2LFO, Arpeggio/Step Sequencer Generator, 4 Track FreeEG

POLYPHONY :

5 notes maximum (latest note priority; polyphony is expandable *1)

*1 Depending on the particular "mother" device, up to eight additional boards can be installed, for a total of 40-note polyphony. On the CS6x, for example, two boards can be installed for a maximum of 10 notes; on the MU128, three boards can be installed for a maximum of 15 notes.

NUMBER OF VOICES :

236 XG voices (AN-XG/A, AN-XG/B)
256 Preset voices
128 User voices

INTERFACE :

XG Plug-in connector

EFFECTOR :

Guitar Amp.Simulator (Distortion)
3-Band EQ
XG Part EQ

DIMENSIONS (W x H x D) : 138.5 x 89.0 x 8.5mm

WEIGHT : 65g

POWER REQUIREMENTS : 320mA

INCLUDED ITEMS : Owner's Manual, Floppy disk (3)

* Specifications subject to change without notice.

About the Included Floppy Disks

The three included floppy disks contain editing software for the PLG150-AN as well as demonstration songs and Voice/Performance data for the "mother" device.

To use the editing software and transfer the song/Voice/Performance data to your particular "mother" device, you should have a computer (running Windows 95/98) with a MIDI interface, with the MIDI OUT on the interface connected to the MIDI IN of the "mother" device. You should also have XGworks (v3.0 or higher) or XGworks lite installed to your computer; this is necessary to use the editing software (page 17). For playing back the demonstration songs and transferring the Voice/Performance data, you can use any compatible sequence software (such as XGworks/XGworks lite) or hardware sequencer capable of sending bulk data. Insert Disk #1 into the computer and start the installation.

The following software is included on the disks:

■ **AN Easy Editor (page 17)**

■ **AN Expert Editor (page 17)**

■ **Demonstration Songs**

**(1) “AN Solo” (for Modular Synthesis Plug-in System devices:M_Solo.MID)
(for XG Plug-in System devices:X_Solo.MID)**

By: Katsunori Ujiiie (Idecs, Inc.)

For: Modular Synthesis Plug-in System devices (CS6x, etc.) and XG Plug-in System devices (MU128, etc.)



To play this song with a Modular Synthesis Plug-in System device (such as the CS6x, etc.), first call up the Voice mode (press the VOICE button), then press PLG1 or PLG2 (depending on which slot the PLG150-AN board has been installed to), and select a voice.

(2) “R&B” (R&B.MID)  

By: Takashi Morio

For: XG Plug-in System devices (MU128, etc.)

(3) “Old Tek” (Old_Tek.MID) 

By: Takashi Morio

For: XG Plug-in System devices (MU128, etc.)

(4) “Progressive Rock” (Progrock.MID) 

By: Katsumi Nagae (Idecs, Inc.)

For: XG Plug-in System devices (MU128, etc.)

(5) “Trance” (Trance.MID)

By: Katsumi Nagae (Idecs, Inc.)

For: MU128/MU100/MU100R

■ **Plug-in Voice Data for the CS6x/CS6R/S80
(Modular Synthesis Plug-in System)**

This is Plug-in voice data, featuring a total of 64 voices that were created using the PLG150-AN Preset voices. When the PLG150-AN is installed to PLG1, select the file “PLG_vce1.MID”; when the board is installed to PLG2, select the file “PLG_vce2.MID.”



For a complete list of these voices, refer to the Plug-in Voice List (page 45) in the Owner’s Manual.

■ **Performance Data for the MU128/MU100/MU100R (XG Plug-in System)**

This is Performance data, featuring a total of 64 Performances that were created using the PLG150-AN Preset voices (“AN_Perf.MID”).



For a complete list of these Performances, refer to the Performance List (page 46) in the Owner’s Manual.

Installing the PLG150-AN

For detailed instructions on installing the PLG150-AN, refer to the owner's manual of the Plug-in-compatible "mother" device (e.g., CS6x, MU128, etc.).

Included Items

The following items have been included in the package of your new PLG150-AN. Please make sure that you have them all before starting to setup and use the instrument. If an item is missing, contact the store or dealer from which you purchased the PLG150-AN.

- PLG150-AN board
- PLG150-AN Owner's Manual (this book)
- Three floppy disks

Required and Recommended Items

In addition to the included items listed above, you should also have the following:

Synthesizer/Tone Generator/Sound Card Compatible with the Modular Synthesis or XG Plug-in Systems

In order to use the PLG150-AN, you'll need a synthesizer, tone generator or sound card compatible with the Modular Synthesis Plug-in System or the XG Plug-in System. Compatible instruments include the CS6x, MU128, and the SW1000XG. The synthesizer/tone generator/sound card should also have an available slot or space for installing the PLG150-AN.

XGworks or XGworks lite Music Sequencing Software

These software sequencers provide convenient tools for taking full advantage of the PLG150-AN, letting you create song data that automatically selects and plays back the AN voices. They also include the powerful AN Easy Editor and AN Expert Editor (see below) for editing and controlling the AN voices. XGworks lite is contained on a CD-ROM included with the CS6x, MU128, etc., and XGworks is contained on a CD-ROM included with the SW1000XG.

AN Easy Editor

The AN Easy Editor is a special plug-in software module for XGworks and XGworks lite. It provides convenient easy-to-use control over the most important PLG150-AN settings and parameters. It also provides exceptionally intuitive editing, with a virtual “front panel” display that lets you change the settings with knobs and buttons.

Using the AN Easy Editor is just like using the Part editing controls on your tone generator — it indirectly and temporarily changes the AN voices without making changes to the original voice. The changed parameters can either be inserted into a song to automate sound changes, or can be saved as an AN parameter file for future recall. Continuous real-time parameter changes can be recorded to a song as well. The AN Easy Editor software is contained on the included floppy disks.

AN Expert Editor

As with AN Easy Editor above, the AN Expert Editor is special software for use with XGworks and XGworks lite. It allows you to directly edit all of the AN voice settings and parameters from your computer. It also provides exceptionally intuitive editing, with a virtual “front panel” display that lets you change the settings with knobs, buttons and other controls.

More comprehensive than the AN Easy Editor above, the AN Expert Editor gives you convenient access to all of the PLG150-AN’s parameters, controls and functions. The changed parameters can either be inserted into a song to automate sound changes, or can be saved as an AN Expert Data file for future recall. Continuous real-time parameter changes can be recorded to a song as well. It also lets you save your edits directly as a User voice for future recall.

The AN Expert Editor software is contained on the included floppy disks.

Installing and Starting the Plug-in Editor Software (Windows 95/98)

Installing the Software

Double-click the “Setup.exe” file in the “plg-an” folder on the floppy disk to start the installation. Click “Next” or “Yes” and follow the subsequent instructions on the screen to complete the installation.

Starting the AN Easy Editor

- 1 Start XGworks (or XGworks lite).
- 2 Click the “Plug-in” menu and select “AN Easy Editor.”
Alternately, press Alt + P, then A, and ENTER. The “Select AN Part” dialog box appears.
- 3 Set the desired Part number and click “OK.”



The AN Easy Editor window appears.

If the PLG150-AN has been properly installed and all computer/MIDI connections have been properly made, operating the AN Easy Editor should directly affect the PLG150-AN. For details on using the AN Easy Editor, refer to the on-line help file that is included with the software.



When using a Modular Synthesis Plug-in System “mother” device, the Part assignment depends on which mode is used — Voice or Performance — and also on whether the PLG150-AN board is installed/assigned to PLG1 or PLG2, as described below.

When using the Voice mode:

Depending on which slot the PLG150-AN board has been installed to, press PLG1 or PLG2, then set the Part to “1” (no matter what the PLG1 or PLG2 assignment is).

When using the Performance (Multi) mode:

If the PLG150-AN board is assigned to PLG1, set the Part to “16.”

If the PLG150-AN board is assigned to PLG2, set the Part to “15.”

Starting the AN Expert Editor

- 1 Start XGworks (or XGworks lite).
- 2 Click the “Plug-in” menu and select “AN Expert Editor.”

Alternately, press Alt + P, then A (twice), and ENTER.
The “Select AN Part” dialog box appears.



- 3 Set the desired Part number and click “OK.”
The AN Expert Editor window appears.

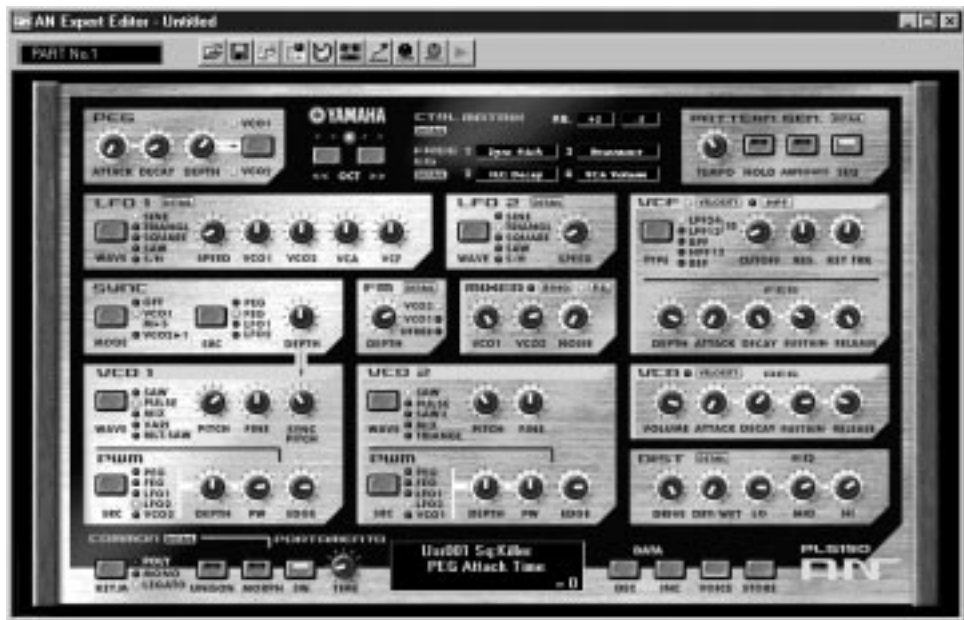

If the PLG150-AN has been properly installed and all computer/MIDI connections have been properly made, operating the AN Expert Editor should directly affect the PLG150-AN. For details on using the AN Expert Editor, refer to the on-line help file that is included with the software.



- To use the AN Expert Editor, your copy of XGworks must be version 1.05 or later. You can download the proper update of XGworks or XGworks lite from the Yamaha website (<http://www.yamaha.co.uk>).
- When using a Modular Synthesis Plug-in System “mother” device, the Part assignment depends on which mode is used — Voice or Performance — and also on whether the PLG150-AN board is installed/assigned to PLG1 or PLG2, as described below.

When using the Voice mode:

Depending on which slot the PLG150-AN board has been installed to, press PLG1 or PLG2, then set the Part to “1” (no matter what the PLG1 or PLG2 assignment is).

When using the Performance (Multi) mode:

If the PLG150-AN board is assigned to PLG1, set the Part to “16.”
If the PLG150-AN board is assigned to PLG2, set the Part to “15.”

Selecting AN Voices (Modular Synthesis Plug-in System)

When the PLG150-AN is installed to a CS6x Control Synthesizer, the AN voices can be selected in the same way as the internal voices of the synthesizer.

NOTE The example displays used in the following explanations are all taken from the CS6x.

Enabling and Selecting AN Voices

- 1 Press the VOICE button.
- 2 Press the appropriate PLG button (PLG1 or PLG2, depending on which slot the PLG150-AN board has been installed to), then press the appropriate BANK button and PROGRAM button to select the desired Plug-in voice.

```
▼VCE Play) PLG1:001(A01)[--:Killer  ]  
EQLow-G EQMid-G EQHi-G -----
```

NOTE To select a different bank, simultaneously hold down the appropriate PLG button and turn knob C (or press the DEC/INC buttons) to select the desired bank. The bank is expressed in two numbers: MSB and LSB.

```
▼VCE Play) PLG1:001(A01)[--:Killer  ]  
BANK= 036/000
```

If a selected bank is not available, the bank letter indication in the display (A - H) will not change. For a list of the available banks and their MSB/LSB values, refer to the “AN-XG Voice Map” at the back of this manual (pages 43 — 44).

Editing the AN Native Part Parameters (Modular Synthesis Plug-in System)

NOTE

- Keep in mind that the parameter values and settings below represent offsets of the actual voice settings. This means that adjustments made to the parameters may not make much change in the actual sound, depending on the original settings of the voice. For parameter values, a setting of "0" results in no change, while positive and negative values increase and decrease the value respectively.
- The following explanations show how to edit the AN native part parameters when creating PLG voices, using the CS6x Control Synthesizer as an example. For information on storing the PLG voices with your particular Modular Synthesis Plug-in System compatible instrument, refer to the owner's manual of that instrument.

1 Select the desired AN voice, as described in "Selecting AN Voices" on page 20.

2 Press the EDIT button.

The EDIT menu display appears.

```
▼GEN Name) Pf-S4      a-Z      0-?  Cursor  
Common                [--:Killer ]
```

3 Turn knob A clockwise until "Elem" is shown at the bottom left of the display.

```
▼PLG Assign)          Bank  Number  
Elem                 ▶036/000  1[Killer ]
```

4 Turn the PAGE knob clockwise until "PLG150-AN" is shown at the bottom left of the display.

Keep turning the knob to select the different AN Part parameters, indicated just above knob C and knob 2.

```
◆NTU Param)         Unison Sw  Arr/SEQ Sw  
PLG150-AN          Uce           Off
```

5 Use knobs C and 2 to select the desired parameter and change the value.

Once one of the parameters is selected (the arrow cursor appears next to the value), you can also adjust the value with the DATA knob or the DEC/INC buttons.

NOTE

- In order to store User voices on a Modular Synthesis Plug-in System compatible instrument that have been edited/created with the computer-based AN Expert Editor (or with the compatible instrument itself), you'll need to use an external memory device, such as a memory card. For details on storing voices, refer to the owner's manual of your Modular Synthesis Plug-in System compatible instrument.
- The actual parameter names may differ, depending on whether the instrument you are using is XG Plug-in System compatible or Modular Synthesis Plug-in System compatible. For details, refer to the Parameter List (XG / Modular Synthesis Plug-in System) on page 50.

HINT

You can use the Mono/Poly Mode and Portamento Switch parameters in tandem to create a smoother note-to-note sound when playing legato passages. To do this, set Mono/Poly Mode to "Mono" and Portamento Switch to "On." When set in this way, successively played notes do not retrigger the PEG, FEG or AEG, resulting in a smoother, more consistent sound.

Selecting/Editing the AN System Parameters (Modular Synthesis Plug-in System)



The example displays used in the following explanations are all taken from the CS6x.

1 Press the UTILITY button.

The Utility Mode display appears.

```
▼MSTR TG>    Vol          NtShift    Tune
Sys          ▶127          + 0 +    0.0c
```

2 Turn the PAGE knob clockwise until “PLG150-AN” is shown at the bottom left of the display.

Keep turning the knob to select the different AN System parameters, indicated just above knob C and knob 2.

```
◆PLG1 MIDI>  Mreh Ctr1No    Mreh Pgm No
PLG150-AN    0              0
```

3 Use knobs C and 2 to select the desired AN System parameter and change the value.

Once one of the parameters is selected (the arrow cursor appears next to the value), you can also adjust the value with the DATA knob or the DEC/INC buttons.

Selecting AN Voices (XG Plug-in System)

The PLG150-AN voices can be selected just like the voices of the XG tone generator. Keep in mind, though, that they can only be selected when the Sound Module Mode is set to XG or Performance. Also, the Part Assign parameter in the Utility mode (see below) must be set to the desired Part.

NOTE The example displays used in the following explanations are all taken from the MU128.

Enabling and Selecting AN Voices

1 Set the Sound Module Mode to “XG” or “PFM” (Performance).

Press the MODE button and use the SELECT ◀/▶ buttons.

NOTE The Performance mode is not available on the SW1000XG.

2 Set the Part Assign parameter to the desired Part number.

To do this:

- 1) Press the UTIL button.
- 2) Select the “PLUGIN” menu (with the SELECT ▶ button) and press ENTER.
- 3) Select the “PLG150-AN” menu if necessary (with the SELECT ◀/▶ buttons), and press ENTER.
- 4) Select the Part Assign parameter (with the SELECT ◀ button), and use the VALUE -/+ buttons or dial to change the Part number.

NOTE The Part Assign range for the XG mode is 1 - 16 and “off”; for the Performance mode, it is 1 - 4 and “off.”

Press the EXIT button to return to the Play mode.

This operation can also be quickly and conveniently done from the AN Easy Editor or AN Expert Editor (in XGworks).

3 Enable the PLG150-AN board for the desired Part.

First, make sure that the appropriate Part is selected (using the PART +/- buttons), then press the SELECT button. The icon of the selected board appears in the display and the corresponding LED at the bottom of the panel (PLG-1, -2, or -3) flashes briefly.

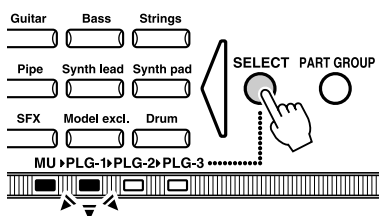

4 Select the desired bank number.

Move the cursor to the Bank Number parameter with the SELECT ◀/▶ buttons and use the VALUE -/+ buttons to select the desired bank.

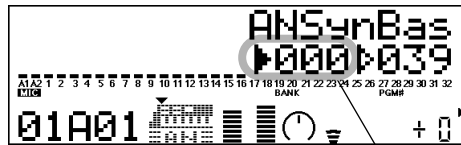

Bank Number parameter

5 Select the desired voice number.

Move the cursor to the Voice (Program) Number parameter with the SELECT ◀/▶ buttons and use the VALUE -/+ buttons to select the desired voice.

NOTE Voices (and Voice banks) can also be selected by using the Voice Category buttons.

Alternately, you can select voices from a connected MIDI keyboard, or from sequencing software (such as XGworks) on a connected computer.

For a list of available voices and their bank/voice numbers, see page 43.

Editing the AN Native Part Parameters (XG Plug-in System)

Any of the AN voices can be freely edited from the front panel with the AN Part parameters. These same parameters can also be edited from a computer using the AN Easy Editor software (in XGworks).

Keep in mind that changing the Part parameters does not permanently affect the original voice settings. The edits that you make here temporarily change the settings of the currently selected voice. When you select a different voice for the Part, the settings are applied to the newly selected voice.



- The Part parameter settings cannot be saved in Multi Play mode. If you wish to save your Part parameter edits, do it from the Performance mode or the AN Easy Editor. If you wish to save your edits to a voice, use the AN Expert Editor software to edit the parameters of a voice, then save it as a User voice.
- The example displays used in the following explanations are all taken from the MU128.

1 Select the Part having the AN voice, then select the desired voice.

Select the appropriate Part with the PART +/- buttons, then, with the cursor at the Voice Number parameter, select the desired voice.

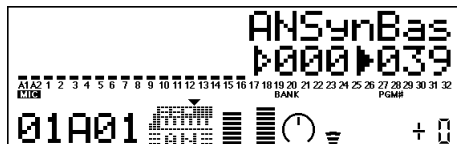

2 Press the EDIT button to enter the Edit mode.



3 Select the "PLUGIN" menu.

Use the SELECT ▶ button, then press the ENTER button. The PLG150-AN Edit menu appears.

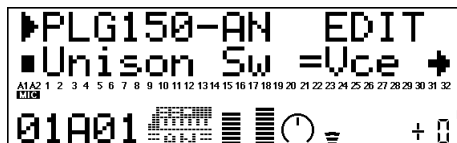

4 Select the desired parameter.

Use the [SELECT ◀▶] buttons.

5 Adjust the value or change the setting for the selected parameter.

Use the [VALUE +/-] buttons.

6 Return to the main Play display.

Press the [EXIT] button several times, or press the [PLAY] button once.



- When an AN voice is selected from one of the custom banks (Preset 1, Preset 2, or User), the AN voice's settings for the following parameters take precedence over the corresponding XG Part settings.

Mono/Poly Mode
Pitch Bend Control
Portamento Switch
Portamento Time

In other words, the settings of these XG Part parameters (on an MU128, etc.) are replaced by those of the selected AN voice. Naturally, once the voice is selected, the Part parameter values can then be changed from the panel of the XG-compatible "mother" device (MU128, etc.), or by sending appropriate MIDI messages.

- When an AN voice is properly assigned to a Part on an XG-compatible "mother" device (MU128, etc.), the AN voice can be changed by editing the XG Part parameters from the panel. However, for the following XG Part parameters, changing the value has no effect on the sound (even though the value changes in the display).

PEG ReleTime (Pitch EG Release Time)
PEG ReleLvl (Pitch EG Release Level)

Selecting/Editing the AN System Parameters (XG Plug-in System)

The parameters that apply to the entire system of the PLG150-AN are included in the Utility mode menu of the XG tone generator.

NOTE The example displays used in the following explanations are all taken from the MU128.

1 Press the [UTIL] button.

The Utility mode menu appears.



2 Select the “PLUGIN” menu.

Use the [SELECT ►] button to highlight “PLUGIN,” then press the [ENTER] button.



3 Select the PLG150-AN board.

If the PLG150-AN board is the only one installed, “PLG150-AN” is already displayed and can be selected by pressing the [ENTER] button. If additional boards have been installed to the tone generator, you may need to select “PLG150-AN.” To do this, first use the [SELECT ◀▶] buttons, then press [ENTER].

The System parameter menu for the PLG150-AN appears.

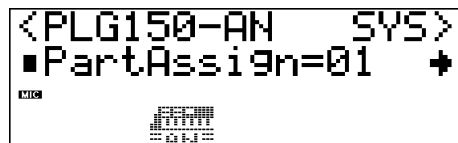

4 Select the desired parameter.

Use the [SELECT ◀▶] buttons.

5 Adjust the value or change the setting for the selected parameter.

Use the [VALUE +/-] buttons.

6 Return to the main Play display.

Press the [EXIT] button several times, or press the [PLAY] button once.

AN Native Part Parameters

Keep in mind that the parameter values and settings represent offsets of the actual voice settings. This means that the actual sound that results from the settings made here depends on the original settings of the voice.

Also keep in mind that these are “Part” parameters and as such, are temporary; they simply alter or offset the settings of the currently selected voice. The original voice settings are permanently maintained in memory.

For parameter values, a setting of “0” results in no change, while positive and negative values increase and decrease the value respectively.

Let’s look at a specific example. If the original Mix VCO1 Level parameter of the selected voice is set to 100, and you set the Mix VCO1 Level (below) to “-25,” the actual Mix VCO1 Level will become “75.” If you set it to “+10,” the value will become “110.” Naturally, this also means that the parameter value cannot be increased or decreased beyond its maximum or minimum values. In our example, Mix VCO1 Level values higher than “+27” have no effect on the sound, since the actual range is 0 — 127.



- Depending on the selected voice and the particular parameter being edited, the sound or actual parameter value of certain voices may change very little or not at all, even when the parameter value is changed drastically.
- For Modular Synthesis Plug-in System compatible devices, the voices you edit/create can be stored to the device as PLG voices. For details on storing voices, refer to the owner’s manual of your Modular Synthesis Plug-in System compatible instrument.

■ Unison Sw (Unison Switch)

Settings: vce (voice), off, on

This determines whether the Unison mode is on or off. Setting this to on is an instant way to get a “fat” analog-like lead sound. When Unison is on, the selected voice is layered with slightly detuned copies of itself, and set to play monophonically (one note at a time). When this is set to “vce” (voice), the default Unison Switch setting for the voice is used. In other words, the Unison mode will turn on and off automatically, depending on the selected voice.



- This setting overrides the Mono/Poly Mode parameter setting (of the Modular Synthesis Plug-in System PLG voice or the XG Part). Even if the PLG voice or the XG Part is set to “poly,” the voice will only play monophonically (with up to five voices sounding together) when Unison Switch is set to on.
- All voices in the AN-XG voice bank have a default Unison Switch setting of “off.” This means that setting this parameter to “vce” (voice) is the same as setting it to “off.”

■ Arp/SEQ Sw (Arpeggio/Step Sequencer Switch)

Settings: vce (voice), off, on

This determines whether the Arpeggio or Step Sequencer is on or off. When this is set to on, the Arpeggio or Step Sequencer function can be used. When this is set to “vce” (voice), the default Arpeggio/Step Sequencer Switch setting for the voice is used. In other words, the Arpeggio/Step Sequencer will turn on and off automatically, depending on the selected voice.



Refer to the Preset1/2 Bank Voice List (pages 38 — 41) for details on whether the Arpeggio or Step Sequencer is set to on or not for the selected voice.

■ Tempo

Settings: vce (voice), midi (midi clock), 40 - 240 bpm

This determines the tempo for the PLG150-AN's internal clock in beats per minute (bpm), over a range of 40 - 240 bpm. The Tempo setting controls the playback of both the Arpeggio and Step Sequencer. When Tempo is set to “midi,” the clock of the PLG150-AN can be controlled by the clock of an external MIDI device such as a music sequencer, connected to the MIDI IN terminal. When this is set to “vce” (voice), the default Tempo setting for the voice is used.

When the Free EG Length parameter is set to one of the “bar,” the Free EG sequence will be synchronized with the Tempo set here.

■ LFO2 Speed

Range: -64 — +63

This determines the speed of the LFO2 modulation. The higher the value, the greater the modulation speed.



The LFO1 speed is controlled by Vibrato Rate in the Modular Synthesis Plug-in System PLG voice and the XG Part parameters. (Refer to the manual of your specific synthesizer/tone generator.)

■ Sync Pitch (Oscillator Sync Pitch)

Range: -64 — +63

This determines the pitch of the slave oscillator in semitones, available only when Sync is set to on. This lets you create a difference in pitch between master and slave oscillators and control the resulting harmonic interval.

Higher values increase the interval, and lower values result in a softer sound.



- To achieve a discernible result, make sure that the VCO1 Level (page 31) is set to an appropriately high value.
- For voices whose Oscillator Sync Mode parameter is set to off, this parameter cannot be changed (“****” appears in the display).

■ FM Depth

Range: -64 — +63

This determines the amount of modulation created by the FM function. Higher values result in greater modulation depth.



- This parameter differs from that in FM Synthesis (such as used by DX-series synthesizers). Too deep of a setting will change the pitch of the voice.
- Depending on the selected voice, this parameter may not be changeable (“****” appears in the display).

■ VCO Detune

Range: -64 — +63

This determines the amount of pitch difference between VCO1 and VCO2.

■ VCO1 Edge

Range: -64 — +63

This determines the sharpness or smoothness of the edge of the VCO1 waveform. Higher (positive) values produce a sharper wave, resulting in a harsher sound. Lower (negative) values produce a rounder wave, resulting in a softer sound. A value of “-64” results in a sine wave.

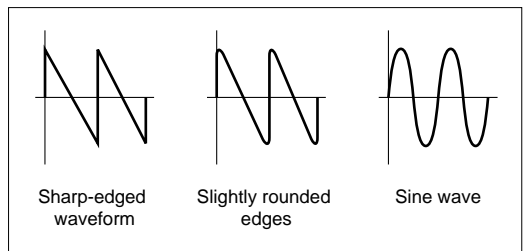

■ VCO1 PW (Pulse Width)

Range: -64 — 0 — +63

This determines the width of the VCO1 pulse wave. Higher (positive) values produce more harmonics, resulting in a fatter sound. In general, pulse width is used to control the pulse wave; however, the PLG150-AN can use PW with other waves as well, for a wider possible variety of sounds than usual.

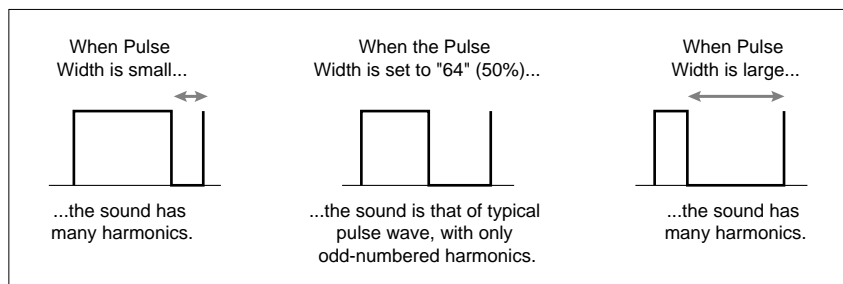

■ VCO1 PWMDp (Pulse Width Modulation Depth)

Range: -64 — +63

This determines the amount of depth of the pulse width modulation of the VCO1, based on the PWM Source parameter. Higher (positive) values produce a deeper modulation.



For most of the voices, the PWM Source is set to LFO2, but for some voices this is set to LFO1 or another setting (depending on the selected voice).

■ VCO2 Edge

■ VCO2 PW (Pulse Width)

■ VCO2 PWMDp (Pulse Width Modulation Depth)

These parameters are the same as those of VCO1, described on pages 30 — 31.

■ Mix VCO1 (Mix VCO1 Level)

Range: -64 — +63

This determines the balance of the VCO1 level in relation to the VCO2, Ring Modulator, and Noise levels. Higher values result in a higher VCO1 level. Set this to "-64" when not using VCO 1.

■ Mix VCO2 (Mix VCO2 Level)

Range: -64 — +63

This determines the balance of the VCO2 level in relation to the VCO1, Ring Modulator, and Noise levels. Higher values result in a higher VCO2 level. Set this to "-64" when not using VCO 2.

■ Mix RingMd (Mix Ring Modulator Level)

Range: -64 — +63

This determines the balance of the Ring Modulator level in relation to the VCO1, VCO2, Noise, and VCA Feedback levels. The higher the value, the greater the Ring Modulator level. When not using the Ring Modulator, set this value to "-64."



The Ring Modulator combines the VCO1 and VCO2 signals. It is particularly effective for producing dissonant interval sounds with a clangorous, or metallic effect.

■ Mix Noise (Mix Noise Level)

Range: -64 — +63

This determines the balance of the Noise signal in relation to the VCO1, VCO2, Ring Modulator, and VCA Feedback levels. The higher the value, the greater the Noise Level. When not using Noise, set the level value to "-64."



By mixing in Noise and using the AN Expert Editor to select an appropriate Filter Type (such as VCF, HPF, etc.), you can create a wide variety of unique "special effect" sounds.

■ Mix FdBack (Mix Feedback Level)

Range: -64 — +63

This determines the level of feedback output from the VCA that is returned (or “fed back”) into the input of the mixer, causing the signal to build up in amplitude according to the level you set. Higher values increase the Feedback level, resulting in a fatter sound.

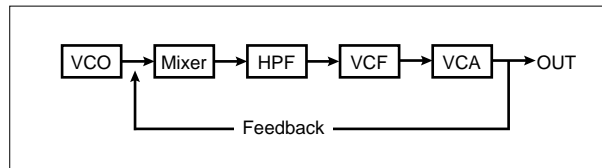

- Feedback should be applied slowly and with caution. Too much feedback can create extremely high frequencies, potentially resulting in damage to your speakers.
- Too much feedback may drastically change the VCF characteristics.

■ VCF FmodDp (Filter Modulation Depth)

Range: -64 — +63

This determines the depth of the filter modulation of the VCF by the LFO1 or LFO2 (depending on the voice selected). Filter Modulation adds a cyclical change to the filter cutoff frequency to create a wah effect. Higher (positive) values widen the range of the cutoff frequency change.

■ FEG Depth (Filter EG Depth)

Range: -64 — +63

This determines the range of movement of the cutoff frequency. Higher (positive) values increase the FEG Depth. This must be set to a proper level for the FEG parameters (Attack, Decay, Sustain, and Release) to have an effect on the sound.

■ FEG Attack (Filter EG Attack Time)

Range: -64 — +63

This determines the attack time of the FEG, which is the time it takes for the signal to reach its maximum cutoff frequency level after a key is pressed (key on). Higher values produce a longer Attack time.

■ FEG Decay (Filter EG Decay Time)

Range: -64 — +63

This determines the decay time of the FEG, which is the time it takes for the signal to reach its sustain level from the maximum level while a key is held. Higher values produce a longer Decay time.

■ FEG Sustin (Filter EG Sustain Level)

Range: -64 — +63

This determines the level of sustain of the FEG, which is the fixed level of the cutoff frequency maintained as long as the key is held. Higher values increase the Sustain level.

■ FEG Releas (Filter EG Release Time)

Range: -64 — +63

This determines the release time of the FEG, which is the time it takes for the filter to reach a level of “0” after a key is released (key off). Higher values increase the Release time.

■ VCA AmodDp (VCA Amplitude Modulation Depth)

Range: -64 — +63

This determines the depth of the amplitude modulation of the VCA by the LFO1 or LFO2 (depending on the voice selected). Amplitude Modulation adds a cyclical change to the volume level to create a tremolo effect. Higher (positive) values widen the range of the volume change.

■ AEG Attack (Amplitude EG Attack Time)

Range: -64 — +63

This determines the attack time of the AEG, which is the time it takes for the signal to reach its maximum volume level after a key is pressed (key on). Higher values produce a longer Attack time.

■ AEG Decay (Amplitude EG Decay Time)

Range: -64 — +63

This determines the decay time of the AEG, which is the time it takes for the signal to reach its sustain level from the maximum level while a key is held. Higher values produce a longer Decay time.

■ AEG Sustin (Amplitude EG Sustain Level)

Range: -64 — +63

This determines the level of sustain of the AEG, which is the level at which the volume will be maintained as long as the key is held. Higher values increase the Sustain level.

■ AEG Releas (Amplitude EG Release Time)

Range: -64 — +63

This determines the release time of the AEG, which is the time it takes for the signal to reach a level of “0” after a key is released (key off). Higher values increase the Release time.

■ Dist Drive (Distortion Drive)

Range: off, -63 — +63

This determines the amount of distortion “drive” for the guitar amplifier simulation effect block. The higher the value, the greater the degree of distortion in the sound. When this is set to “off,” the guitar amplifier simulation block is bypassed, regardless of the setting of the selected voice.

■ AC1CtrlPm (AC1 Control Parameter Number)

Settings: off, P:1 — P:46

This determines which PLG150-AN parameter number is to be controlled by the Assignable Controller (AC1). This allows you to continuously control any one of the PLG150-AN parameters in real time with the desired MIDI controller (modulation wheel, breath controller, foot controller, etc.). For a list of the parameters that can be controlled, see page 49. When this is set to “off,” AC1 control over the PLG150-AN is disabled.



The actual controller that is used to affect the PLG150-AN is determined by the Assignable Controller 1 Control Change Number parameter (in the Modular Synthesis Plug-in System PLG voice or the XG Part parameters). Refer to the relevant section in the manual of your specific synthesizer/tone generator.

■ AC1CtrlDp (AC1 Control Depth)

Range: -64 — drct (direct) — +63

This determines the depth over which the AC1 controller affects the specified PLG150-AN parameter (set in AC1 Control Parameter Number above).

When the Control Depth is set to “drct,” the Direct Control function is enabled, allowing you to directly edit the parameter assigned to the controller within its original range.

AN System Parameters

■ Part Assign

Settings: 01 — 16, off

This determines the Part to which the PLG150-AN voice is assigned. If a Part is not properly assigned here, none of the PLG150-AN voices can be selected for the Part. (This applies to XG Plug-in System compatible “mother” devices.)



The PLG150-AN voices can only be assigned to a single Part.

■ Vel Curve (Velocity Curve)

Settings: norm, soft1, soft2, easy, wide, hard

This determines how key velocity (the strength at which the keys are played) affects the volume of the voices. Six different preset velocity “curves” let you quickly tailor the response to your playing preferences.

- **norm (Normal)**

The volume of the sound changes in direct proportion to the strength at which you play the keyboard.

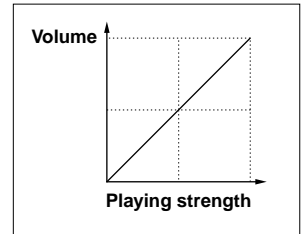

- **soft1**

Compared to “norm,” this curve produces greater volume in the soft velocity range, making it suitable for players having a light touch.

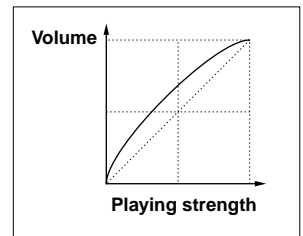

- **soft2**

This curve also produces greater volume in the soft velocity range, but is less pronounced than “soft1” above.

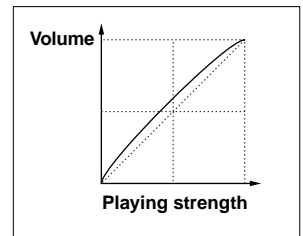

- **easy**

This curve also produces greater volume in the soft velocity range, but results in a more consistent, stable response throughout the entire velocity range than the other “soft” curves .

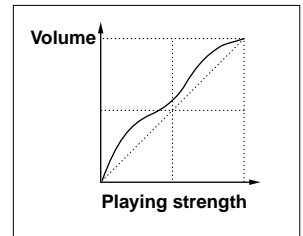

- **wide**

This curve decreases the volume for softer velocities and increases it for stronger velocities, resulting in a wider dynamic range overall.

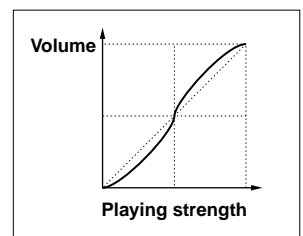

- **hard**

Compared to “norm,” this curve produces greater volume in the hard (strong) velocity range, making it suitable for players having a heavy touch.

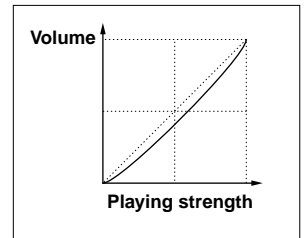

■ Mrph CtrlNo (Morphing Control Change Number)

Settings: off, 1 — 95, AT

This determines which MIDI controller (modulation wheel, breath controller, foot controller, etc.) is used to “morph” or crossfade between two different voices.

Morphing is an exceptionally powerful function that allows you to use any MIDI controller to “morph” or crossfade between two distinct voices — in real time as you play. Naturally, the controller data can be recorded to a sequencer for automated morphing within a song as well.

Any one of the 95 control change numbers can be used as the Morphing controller. When this is set to “AT,” channel after touch (the amount of pressure you apply to the keys while holding them down), is used to morph between voices. When this is set to “off,” the Morphing function is cancelled.



The Morphing function affects the following voice parameters:

[PEG]	PEG Attack Time, PEG Decay Time, PEG Depth
[LFO]	LFO1 Speed, LFO2 Speed, LFO1 Delay
	VCO1 Pmod Depth, VCO2 Pmod Depth, VCA Mod Depth, VCF Mod Depth
[SYNC]	Sync Pitch Control Depth
[FM]	FM Depth
[VCO1]	VCO1 Pitch, VCO1 Fine, PWM Depth, PW, Edge, Sync Pitch
[VCO2]	VCO2 Pitch, VCO2 Fine, PWM Depth, PW, Edge
[MIXER]	VCO1 Level, VCO2 Level, Noise Level, Ring Mod. Level, Feedback Level
[VCF]	VCF Cutoff, Resonance, Key Track, HPF Cutoff, FEG Velocity Sense
	FEG Depth, FEG Attack, FEG Decay, FEG Sustain, FEG Release
[VCA]	Volume, Velocity Sense,
	AEG Attack, AEG Decay, AEG Sustain, AEG Release

Parameters not listed here do not respond to the Morphing control and remain fixed at the values set for the currently selected voice (not the Morphing voice).

■ Mrph Pgm No (Morphing Program Number)

Range: 001 — 128

■ MrphBankLSB (Morphing Bank Select LSB Number)

Range: 000 — 002 (when set to Custom; MSB = 036)

000 — 107 (when set to AN-XG/A; MSB = 084)

000 — 076 (when set to AN-XG/B; MSB = 100)

■ MrphBankMSB (Morphing Bank Select MSB Number)

Settings: 036 (Custom), 084 (AN-XG/A), 100 (AN-XG/B)

These parameters are used together to select the “second” voice for the Morphing function. The currently selected voice (called up from the panel or by MIDI) is paired with the voice selected here, letting you “morph” between them.

Each voice is assigned to a different program number — up to a maximum of 128. Each group of 128 voices is assigned to a different voice bank, selectable with the LSB and MSB parameters.

Normally, you should set these parameters in the following order:

- 1) Bank Select MSB (for the Custom, AN-XG/A, or AN-XG/B bank sets)
- 2) Bank Select LSB (for the specific bank)
- 3) Program Number (for the specific voice)



- When the Morphing Control Change Number parameter is set to “off,” the morphing function is cancelled.
- The available range of voices (program numbers) may differ, depending on the selected bank (MSB and LSB).
- The available range of LSB values may differ, depending on the selected MSB value.

■ AN CtrlNo.1 (AN Control Change Number - Assignable Controller 1)

■ AN CtrlNo.2 (AN Control Change Number - Assignable Controller 2)

■ AN CtrlNo.3 (AN Control Change Number - Assignable Controller 3)

■ AN CtrlNo.4 (AN Control Change Number - Assignable Controller 4)

Settings: off, 1 — 95, AT

This determines which MIDI controller (modulation wheel, breath controller, foot controller, etc.) is used for each of the four Assignable Controllers (AC 1 - AC 4). Any one of the 95 control change numbers can be used as the controller.

The Assignable Controllers can be used to affect various parameters, such as the filter, volume, or the Distortion. Naturally, for optimum control, each of these should be set to different values, and they should be different from the Morphing Control Change Number parameter above.

When this is set to “AT,” channel after touch (the amount of pressure you apply to the keys while holding them down), is used to change the selected parameter. When this is set to “off,” the selected Assignable Controller has no effect.



For a list of the available parameters that can be controlled with the Assignable Controllers, refer to the Voice List on pages 38 — 41.

■ Preset 1 Bank Voice List (Bank Select MSB = 36, LSB = 0)

No.	VoiceName	Category	Key Assign		Pattern Generator		AN AC1	AN AC2	AN AC3	AN AC4
			Mode	Unison	Type	Switch	(Default CC#41)	(Default CC#42)	(Default CC#43)	(Default CC#44)
1	Killer	Sq	Legato		StepSEQ	On	Sync Pitch Dp	FEG Decay	FEG Sustain	VCF Cutoff
2	Cream	Ba	Legato		StepSEQ		FEG Decay	FEG Sustain	VCF Cutoff	Resonance
3	2001	Ba	Legato	On	Techno-B		Sync Pitch	FEG Decay	FEG Sustain	VCF Cutoff
4	Uni Saw	Ba	Legato	On	StepSEQ		FEG Decay	FEG Sustain	VCF Cutoff	Resonance
5	Ruff	Ba	Mono		Techno-C		VCF Mod Dp	Dist. Dry/Wet	VCF Cutoff	Resonance
6	Squeaky	Ba	Legato		UpOct2		Sync Pitch	VCO1 Level, Ring Mod	LFO2 Speed	HPF Cutoff
7	BiggMac	Ba	Mono		UpDwBOct1		VCF Mod Dp	FEG Attack	FEG Decay	VCF Cutoff
8	Monty	Ba	Legato		StepSEQ		VCO1 Edge	LFO2 Speed	HPF Cutoff	VCF Cutoff
9	Insomnia	Ba	Poly		StepSEQ		Sync Pitch	VCA Feedback, VCA Volume	PEG Depth	HPF Cutoff
10	Maise	Ld	Poly		UpOct1		Sync Pitch	VCO1 Edge	VCO2 PW	FEG Attack
11	Bombastc	Ld	Legato	On	PulseLine		FEG Decay	FEG Sustain	VCF Cutoff	Resonance
12	ANSyncLd	Ld	Legato		UpDwBOct4		Sync Pitch	VCO1 PW, VCO2 PW	Dist. Dry/Wet	LFO2 Speed
13	Squeamer	Ld	Legato		PulseLine		Sync Pitch	VCF Mod Dp	VCF Cutoff	Resonance
14	Dre-full	Ld	Poly		BassLineC		VCO2 PWM Dp	VCF Mod Dp	HPF Cutoff	VCF Cutoff
15	Faaaat	Ld	Poly		StepSEQ		FEG Decay	FEG Sustain	VCF Cutoff	Resonance
16	VA Pig	Ld	Legato	On	StepSEQ		Sync Pitch	HPF Cutoff	VCF Cutoff	Resonance
17	Lipstick	Ld	Poly		UpOct4		VCO1 Edge, VCO2 Edge	VCF Mod Dp	FEG Attack	HPF Cutoff
18	HardBrss	Br	Poly		Techno-C		VCO1 Pmod Dp, VCO2 Pmod Dp	Portmnt Time	VCF Cutoff	Resonance
19	ToToHorn	Br	Poly		UpDwAOct2		Sync Picth	VCO2 Edge	VCA Feedback	FEG Attack
20	So-Lina	St	Poly		DwOct2		FEG Release	VCF Mod Dp	VCF Cutoff	Resonance
21	MultiSaw	St	Poly		DwOct4		VCO1 Edge	VCO1 Mix	Noise Level	HPF Cutoff
22	Contnent	Pd	Poly		UpOct2		VCO1 Edge, VCO2 Edge	Noise Level	HPF Cutoff	VCF Cutoff
23	PWMSweep	Pd	Poly		UpOct1		Sync Pitch	VCO1 PWM Dp, VCO2 PWM Dp	VCF Cutoff	Resonance
24	Laos	Fx	Poly		UpOct1		Sync Pitch	VCO1 Edge	VCA Feedback	LFO1 Speed, LFO2 Speed
25	CyberBag	Fx	Poly		DAHouse		Sync Pitch	Dist. Dry/Wet	VCO1 Level	HPF Cutoff
26	Unstable	Fx	Poly		UpOct1		Sync Pitch	VCO1 Edge, VCO2 Edge	Dist. Dry/Wet	Portmnt Time
27	Fire	Fx	Poly		StepSEQ		VCO1 Pmod Dp	VCF Mod Dp	LFO2 Speed	FEG Decay
28	Jack	Fx	Poly		UpOct1		LFO1 Speed	Dist. Dry/Wet	VCF Cutoff	Resonance
29	ULTSound	Dr	Poly		UpOct2		VCO2 X-Mod Dp	VCA Feedback	VCO1 Level	PEG Decay
30	HiQ Reso	Pc	Poly		SyncopaA		FEG Decay	Noise Level	Dist. Dry/Wet	VCF Cutoff
31	Fumble	Se	Poly		UpOct1		Sync Pitch	VCO1 Edge	VCO2 X-Mod Dp	HPF Cutoff
32	Invade	Se	Poly		UpOct1		Noise Level	VCO1 Level, VCO2 Level	FEG Attack	FEG Depth
33	FreeEdge	Se	Poly		UpOct2		Sync Pitch Dp	PEG Depth	PEG Decay	VCF Cutoff
34	Touch	Se	Poly		Techno-C		VCO2 X-Mod Dp	AEG Attack	AEG Decay	AEG Release
35	Chemical	Se	Poly		UpOct1		Sync Pitch	FM Depth	LFO1 Speed	HPF Cutoff
36	AnalgAge	Se	Mono		UpOct1		FEG Attack	FEG Decay	FEG Depth	LFO1 Delay, LFO1 Speed
37	Fat Run	Sq	Poly		StepSEQ	On	VCO1 Mix	FEG Decay	VCF Cutoff	Resonance
38	Power	Sq	Legato		StepSEQ	On	Dist. Dry/Wet	FEG Attack	HPF Cutoff	VCF Cutoff
39	Metallic	Sq	Poly		StepSEQ	On	VCA Feedback	Noise Level	FEG Depth	FEG Decay
40	Zebedee	Sq	Legato		StepSEQ	On	VCO1 Edge, VCO2 Edge	VCA Feedback	FEG Attack	FEG Sustain
41	ANSynBas	Ba	Poly		Techno-C		VCO2 Edge	VCO1 Level	VCF Cutoff	Resonance
42	RealMini	Ba	Legato		UpDwBOct1		VCO1 Edge, VCO2 Edge	VCF Mod Dp	FEG Decay, FEG Release	Portmnt Time
43	Chamleon	Ba	Legato		Techno-B		VCO1 Edge, VCO2 Edge	VCF Mod Dp	FEG Decay, FEG Release	Portmnt Time
44	Maxx	Ba	Legato		DwOct2		FEG Decay	FEG Sustain	VCF Cutoff	Resonance
45	BlapMoth	Ba	Mono		Techno-B		FEG Attack	VCF Mod Dp	VCF Cutoff	Resonance
46	Prphtic1	Ba	Legato	On	SyncopaB		FEG Depth	FEG Decay	FEG Sustain	Portmnt Time
47	Prphtic2	Ba	Mono	On	UpOct1		PEG Depth	VCF Mod Dp	VCF Cutoff	Resonance
48	Wonder	Ba	Legato		Techno-C		VCO2 Edge	VCO1 Level	VCF Cutoff	Resonance
49	Slum	Ba	Legato		BassLineC		Sync Pitch	VCF Mod Dp	VCO1 Edge	VCO1 PW
50	X-Bass	Ba	Legato	On	UpDwBOct2		VCO2 X-Mod Dp	VCA Feedback, VCA Volume	Dist. Dry/Wet	HPF Cutoff
51	DustedUp	Ba	Poly		SyncopaA		Sync Pitch	VCO1 Edge, VCO2 Edge	VCA Feedback	HPF Cutoff
52	FootBase	Ba	Poly		SyncopaA		FEG Decay	FEG Depth	VCO2 Level	Dist. Dry/Wet
53	Mini Low	Ba	Legato		UpOct1		Sync Pitch	VCO1 PWM Dp	VCF Cutoff	Resonance
54	DuckBass	Ba	Legato		Techno-C		VCO2 Edge	VCO1 Level	HPF Cutoff	VCF Cutoff
55	10thTone	Ba	Poly		Techno-D		VCO1 Edge, VCO2 Edge	Portmnt Time	VCF Cutoff	Resonance
56	DuckBas2	Ba	Poly		Techno-C		VCO2 Edge	VCO1 Level	HPF Cutoff	VCF Cutoff
57	BirdWrld	Ba	Mono	On	UpDwAOct4		FEG Decay	FEG Depth	VCF Cutoff	Resonance
58	Woodbass	Ba	Poly		BassLineA		Sync Pitch	Dist. Dry/Wet	VCF Cutoff	Resonance
59	RubbaBas	Ba	Mono		SyncoEcho		Sync Pitch	VCO1 Edge	VCF Cutoff	Resonance
60	Smooth	Ba	Legato		TekkEchoA		VCO2 Edge	VCO2 PW	VCA Mod Dp	HPF Cutoff
61	Smoovey	Ba	Poly		UpOct2		Sync Pitch	VCF Mod Dp	VCF Cutoff	Resonance
62	Zed Bass	Ba	Poly		UpDwBOct1		VCF Mod Dp	Dist. Dry/Wet	VCF Cutoff	Resonance
63	Oizo	Ba	Legato		StepSEQ		Sync Pitch	Sync Pitch Dp	VCO1 Edge, VCO2 Edge	VCA Feedback
64	Dog Bass	Ba	Legato		UpOct1		VCO2 Edge	Ring Mod	HPF Cutoff	Resonance
65	Stranger	Ba	Legato		UpOct1		Sync Pitch, Sync Pitch Dp	VCO1 Edge, VCO2 Edge	VCA Feedback	HPF Cutoff
66	Hardstep	Ba	Poly		UpOct1		Sync Pitch	VCO1 Edge	VCO2 Edge	PEG Decay

No.	VoiceName	Category	Key Assign		Pattern Generator		AN AC1	AN AC2	AN AC3	AN AC4
			Mode	Unison	Type	Switch	(Default CC#41)	(Default CC#42)	(Default CC#43)	(Default CC#44)
67	Stevie	Ld	Legato		UpOct1		VCO1 Edge	Dist. Dry/Wet	VCF Cutoff	Resonance
68	Pulsate	Ld	Legato		StepSEQ		VCO1 Edge, VCO2 Edge	Portmnt Time	HPF Cutoff	Resonance
69	Silent	Ld	Legato		UpDwBOct2		VCO1 Edge	VCF Mod Dp	VCA Mod Dp	Portmnt Time
70	KnivesLd	Ld	Mono		SyncopaA		VCO1 Edge	VCO1 PW	VCO2 Level	FEG Decay
71	Pulser	Ld	Legato		Techno-B		VCO1 Edge, VCO2 Edge	VCO2 X-Mod Dp	VCO1 PW	FEG Decay
72	Sliver	Ld	Poly		PulseLine		Sync Pitch	VCF Mod Dp	FEG Attack	VCF Cutoff, Resonance
73	Lucky	Ld	Legato	On	UpOct4		VCO1 PW, VCO2 PW, VCA Volume	VCA Mod Dp	LFO1 Speed	Portmnt Time
74	ANPopcrn	Ld	Mono		BassLineA		VCO2 Level	FEG Depth	Portmnt Time	Resonance
75	X-mod	Ld	Poly		Techno-A		VCO1 Level, VCA Volume	VCO2 X-Mod Dp	VCA Feedback, VCA Volume	LFO2 Speed
76	Caner	Ld	Poly		TekkEchoB		VCO1 Pmod Dp	Dist. Dry/Wet, VCF Cutoff	VCF Cutoff	Resonance
77	ANSyncHd	Ld	Poly		Techno-C		Sync Pitch	Dist. Dry/Wet	LFO1 Speed	VCF Cutoff
78	Chick	Ld	Poly		UpDwBOct4		VCO1 Edge, VCO2 Edge	VCF Mod Dp, LFO1 Speed, VCF Cutoff, Resonance	HPF Cutoff	Resonance
79	Susy	Ld	Poly		DwOct4		Sync Pitch	Dist. Dry/Wet	VCF Cutoff	Resonance
80	EarthLd	Ld	Poly		RandmOct4		Dist. Dry/Wet	Portmnt Time	VCF Cutoff	Resonance
81	P-5 Saw	Ld	Poly		UpOct1		VCO1 Edge, VCO2 Edge	Portmnt Time	HPF Cutoff	VCF Cutoff
82	Rock It	Ld	Legato		StepSEQ		VCO1 Detune	VCO2 Edge	LFO2 Speed	HPF Cutoff
83	DirtySaw	Ld	Poly		StepSEQ		FEG Decay	VCF Mod Dp	PEG Decay	VCF Cutoff
84	Rhubarb	Ld	Mono		Techno-D		Dist. Dry/Wet	Portmnt Time	VCF Cutoff	Resonance
85	J.Hammer	Ld	Legato		DwOct2		Sync Pitch	VCO1 Edge	LFO2 Speed	Portmnt Time
86	X-mod 2	Ld	Legato		UpOct4		VCO1 Edge	VCO2 X-Mod Dp	VCA Feedback, VCA Volume	LFO2 Speed
87	PitchMan	Ld	Poly		BassLineC		FEG Sustain	PEG Depth	VCF Cutoff	Resonance
88	Hyperture	Ld	Legato	On	DAHouse		FEG Decay	FEG Sustain	VCF Cutoff	Resonance
89	EarthLd2	Ld	Legato		Techno-B		Dist. Dry/Wet	Portmnt Time	VCF Cutoff	Resonance
90	Fhomhair	Ld	Legato	On	UpOct1		Sync Pitch	FM Depth	VCO2 Edge	PEG Decay
91	On One	Ld	Legato	On	StepSEQ		VCA Feedback, VCA Volume	Dist. Dry/Wet, VCA Volume	VCF Cutoff	Resonance
92	ANCaliop	Ld	Poly		UpOct4		VCO1 PW, VCO2 PW, VCA Volume	VCA Mod Dp	LFO1 Speed	VCF Cutoff
93	AN Chiff	Ld	Poly		UpDwAOct2		VCA Feedback, VCA Volume	Dist. Dry/Wet	HPF Cutoff	VCF Cutoff
94	Pastel	Ld	Poly		PulseLine		Dist. Dry/Wet	FEG Attack	FEG Decay	FEG Sustain
95	Chromes	Ld	Legato		Techno-B		Sync Pitch	FM Depth	HPF Cutoff	VCF Cutoff
96	MegaDron	Ld	Legato	On	UpOct1		FEG Attack	FEG Decay	FEG Sustain	FEG Release
97	Metal Ld	Ld	Legato	On	BassLineC		Sync Pitch	VCO1 Edge, VCO2 Edge	PEG Decay	VCF Cutoff
98	Hardily	Ld	Mono	On	StepSEQ		VCO1 Edge, VCO2 Edge	Dist. Dry/Wet, VCA Volume	PEG Decay	HPF Cutoff, VCA Feedback
99	Billy	Ld	Poly		PulseLine		Dist. Dry/Wet	FEG Attack	FEG Decay	FEG Sustain
100	Funky	Ld	Poly		StepSEQ		VCO1 Edge, VCO2 Edge	VCO2 X-Mod Dp, VCO2 Level	Dist. Dry/Wet	HPF Cutoff
101	Sun Head	Ld	Legato	On	Techno-B		VCO1 Edge, VCO2 Edge	VCO1 Detune, VCO2 PW	VCA Feedback, VCA Volume	HPF Cutoff
102	AN VoxLd	Ld	Poly		Techno-C		VCF Mod Dp	Noise Level	VCA Feedback	HPF Cutoff
103	Abacab	Ld	Legato		UpOct2		FM Depth	VCF Mod Dp	VCO1 Edge, VCO2 Edge	HPF Cutoff
104	Mr.Hook	Ld	Poly		BassLineA		FEG Decay	PEG Depth	VCF Cutoff	Resonance
105	SupaSync	Ld	Mono		BassLineB		Dist. Dry/Wet	Sync Pitch Dp	VCF Cutoff	Resonance
106	Fatty	Br	Poly		UpDwAOct2		Sync Pitch	VCA Feedback	HPF Cutoff	VCF Cutoff
107	MajorBrs	Br	Poly		SyncEcho		Sync Pitch	VCO1 PWM Dp	VCF Cutoff	Resonance
108	Bronze	Br	Poly		UpDwAOct1		Sync Pitch	PEG Decay	Portmnt Time	Resonance
109	ANSofBr	Br	Poly		UpDwAOct4		HPF Cutoff	VCF Mod Dp	VCF Cutoff	Resonance
110	SlowBras	Br	Poly		UpDwAOct2		FEG Attack	FEG Sustain	VCF Cutoff	Resonance
111	Analog	St	Poly		UpOct1		Sync Pitch	VCO1 Pmod Dp	VCF Cutoff	Resonance
112	Choclote	St	Poly		UpDwAOct2		Sync Pitch	Portmnt Time	VCF Cutoff	Resonance
113	Stringer	St	Poly		UpOct1		Sync Pitch	VCO1 Edge, VCO2 Edge	LFO2 Speed	HPF Cutoff
114	Lush	St	Poly		StepSEQ		Sync Pitch	PEG Decay	VCF Cutoff	Resonance
115	Bonn	St	Poly		UpOct2		VCO1 Edge, VCO2 Edge	VCF Mod Dp	VCO1 Mix	HPF Cutoff
116	PWMStrng	St	Poly		UpDwBOct2		VCO1 Edge, VCO2 Edge	VCF Mod Dp	VCO2 Level	HPF Cutoff
117	AnaStrng	St	Poly		DwOct2		VCF Mod Dp	HPF Cutoff	VCF Cutoff	Resonance
118	StrngPad	St	Poly		UpOct1		Sync Pitch	VCA Feedback	VCF Cutoff	Resonance
119	Hardcore	Sq	Legato		StepSEQ	On	VCO1 Edge, VCO2 Edge	VCA Feedback	Portmnt Time	HPF Cutoff
120	Kangaroo	Sq	Legato		StepSEQ	On	FEG Attack	FEG Depth	FEG Decay, FEG Release	HPF Cutoff, VCA Volume
121	AcidSeq1	Sq	Legato		StepSEQ	On	VCO1 Edge	VCA Feedback	FEG Attack	Portmnt Time
122	AcidSeq2	Sq	Legato		StepSEQ	On	Portmnt Time	FEG Depth	VCF Cutoff	Resonance
123	Harmsync	Sq	Poly		StepSEQ	On	VCO1 Edge, VCO2 Edge	VCA Feedback, HPF Cutoff	Portmnt Time	VCF Cutoff
124	KickLine	Sq	Poly		StepSEQ	On	Sync Pitch	FEG Decay	FEG Sustain	Resonance
125	Free Cut	Sq	Poly		StepSEQ	On	Sync Pitch Dp	FEG Decay	VCF Cutoff	Resonance
126	ElecGroov	Sq	Poly		StepSEQ	On	Sync Pitch	FEG Decay	VCF Cutoff	Resonance
127	ANSeqBas	Sq	Legato		StepSEQ	On	Dist. Dry/Wet	FEG Attack	VCF Cutoff	Resonance
128	Cool man	Sq	Poly		StepSEQ	On	Sync Pitch	VCO1 PWM Dp	FEG Depth	Dist. Dry/Wet

■ Preset 2 Bank Voice List (Bank Select MSB = 36, LSB = 1)

No.	VoiceName	Category	Key Assign		Pattern Generator		AN AC1	AN AC2	AN AC3	AN AC4
			Mode	Unison	Type	Switch	(Default CC#41)	(Default CC#42)	(Default CC#43)	(Default CC#44)
1	Cracker	Ba	Mono		UpOct1		VCO1 Edge, VCO2 Edge	VCO1 PW	VCO2 Level	HPF Cutoff
2	Behind	Ba	Mono		UpOct2		Sync Pitch	FM Depth	VCO2 Edge	HPF Cutoff
3	Rydeen	Ba	Poly		Techno-C		VCO1 Edge, VCO2 Edge	VCO1 PW	Portmnt Time	HPF Cutoff
4	Knives	Ba	Poly		StepSEQ		Sync Pitch	VCO1 PW	VCO2 Edge	HPF Cutoff
5	Knives 2	Ba	Mono		Techno-B		Sync Pitch	VCO2 Edge	VCA Feedback	HPF Cutoff
6	Mg Wood	Ba	Poly		BassLineA		Sync Pitch	VCO1 Edge	VCO2 X-Mod Dp	VCA Feedback
7	Mg Frtls	Ba	Poly		DAHouse		FM Depth	VCO2 X-Mod Dp	Portmnt Time	HPF Cutoff
8	Logic	Ba	Mono		StepSEQ		Sync Pitch	VCO1 Edge, VCO2 Edge	VCA Feedback	HPF Cutoff
9	MgVoice	Fx	Poly		UpOct1		FM Depth	VCO1 Edge, VCO2 Edge	VCA Feedback	Dist. Dry/Wet
10	MgVoice2	Ld	Poly		Techno-C		FM Depth	Noise Level	VCA Feedback	HPF Cutoff
11	MgWhistl	Ld	Legato		UpDwAOct4		VCO1 Level	VCA Mod Dp	Ring Mod, VCA Volume	Portmnt Time
12	MgSoloLd	Ld	Mono		StepSEQ		VCO1 Level	VCA Feedback	Dist. Dry/Wet	Resonance
13	Mg Cat	Ld	Poly		RandmOct2		Sync Pitch	VCO1 Edge, VCO2 Edge	VCA Feedback, VCA Volume	Dist. Dry/Wet
14	Cosmic	Ld	Poly		SyncopaA		Sync Pitch	VCO1 PWM Dp, VCO2 PWM Dp	VCA Feedback	HPF Cutoff
15	Q Lead	Ld	Poly		UpOct2		Sync Pitch	VCO1 Edge	VCO2 Edge	HPF Cutoff
16	5th Ring	Ld	Poly		UpOct1		FM Depth	VCO1 Edge, VCO2 Edge	Portmnt Time	HPF Cutoff
17	DistOdsy	Ld	Poly		TekkEchoB		Sync Pitch	FM Depth	VCO1 Edge, VCO2 Edge	VCO2 PWM Dp
18	ObDetune	Br	Poly		UpOct1		VCO1 Edge, VCO2 Edge	VCO1 Mix	VCO1 Detune	VCA Feedback
19	Hi Wedge	St	Poly		UpOct1		VCO1 Edge, VCO2 Edge	VCO1 Mix	VCO1 Detune	VCA Feedback
20	ObCembal	Pf	Poly		SyncoEcho		Sync Pitch	VCO1 PWM Dp, VCO2 PWM Dp	VCO1 Edge, VCO2 Edge	VCA Feedback
21	ProAtack	Fx	Poly		Techno-C		FM Depth	Noise Level	VCA Feedback, VCA Volume	Resonance
22	ProAtck2	Pd	Poly		UpOct1		VCO1 PWM Dp	VCA Feedback	HPF Cutoff	Resonance
23	Pro Sync	Pd	Poly		UpOct2		Sync Pitch	FM Depth	VCO1 PWM Dp	VCO2 Level
24	ProBrass	Br	Poly		PulseLine		VCO1 Detune	VCO1 Edge	VCO2 Edge	VCF Cutoff
25	Loom	Pd	Poly		UpOct2		VCO1 Edge, VCO2 Edge	VCO1 Detune	Noise Level	VCA Feedback
26	CS80Bras	Br	Poly		UpOct4		VCF Mod Dp	LFO2 Speed	Portmnt Time	HPF Cutoff
27	Behind 2	Fx	Poly		StepSEQ		FM Depth	VCO1 Level	VCF Cutoff	Resonance
28	HarmoSq	Fx	Poly		StepSEQ		Sync Pitch	Sync Pitch Dp	VCF Mod Dp	VCF Cutoff
29	MiniTech	Ld	Poly		StepSEQ		VCO1 Edge, VCO2 Edge	VCO1 Detune	VCO2 PWM Dp	HPF Cutoff
30	Nz Power	Fx	Poly		StepSEQ		Sync Pitch Dp	FM Depth	VCO1 Edge	VCO2 Edge
31	AsianTek	Ld	Poly		StepSEQ		VCO1 Detune	VCO2 X-Mod Dp	Noise Level	VCA Feedback
32	SeqWater	Fx	Poly		StepSEQ		VCO2 X-Mod Dp	VCA Feedback	VCF Cutoff	Resonance
33	HarmoSq2	Fx	Poly		StepSEQ		Sync Pitch	Sync Pitch Dp	FM Depth	Resonance
34	AnaDrum	Dr	Poly		SyncopaA		FEG Depth	Noise Level	VCA Feedback	HPF Cutoff
35	SynthTom	Dr	Poly		UpOct1		Sync Pitch	Sync Pitch Dp	VCO1 Edge, VCO2 Edge	HPF Cutoff
36	SynShake	Dr	Mono		BassLineA		Dist. Dry/Wet	HPF Cutoff	VCF Cutoff	Resonance
37	EthnoTom	Dr	Poly		UpOct1		VCO1 Edge, VCO2 Edge	VCO2 X-Mod Dp	Noise Level	Resonance
38	Contact	Se	Poly		UpOct1		Sync Pitch	Sync Pitch Dp	VCO2 X-Mod Dp	HPF Cutoff
39	EthTeck	Pc	Poly		StepSEQ		FM Depth	VCO2 X-Mod Dp	VCA Feedback	HPF Cutoff
40	India	Et	Poly		StepSEQ		Sync Pitch	FM Depth	VCO1 Edge, VCO2 Edge	VCO1 PWM Dp, VCO2 PWM Dp
41	MaMa	Fx	Poly		UpDwAOct2		VCO1 Detune	VCF Mod Dp	VCA Mod Dp	FEG Attack
42	Magic	Pd	Poly		UpOct2		Sync Pitch	VCO1 Edge, VCO2 Edge	HPF Cutoff	VCF Cutoff
43	Yellow	Pd	Poly		UpOct2		FEG Attack	FEG Depth	VCF Cutoff	Resonance
44	5th Pad	Pd	Poly		DwOct2		FEG Attack	FEG Depth	VCF Cutoff	Resonance
45	Kelp	Pd	Poly		UpDwBOct1		VCO1 Edge, VCO2 Edge	VCF Mod Dp	HPF Cutoff	VCF Cutoff
46	SyncBrPd	Pd	Poly		UpOct1		Sync Pitch	VCO1 Edge, VCO2 Edge	VCF Cutoff	Resonance
47	Soar	Pd	Poly		UpOct2		Sync Pitch	FEG Depth	VCF Cutoff	Resonance
48	AN Bowed	Pd	Poly		UpOct2		VCF Mod Dp	VCA Mod Dp	VCF Cutoff	Resonance
49	AN Dawn	Pd	Poly		UpOct1		VCO1 Detune	VCF Mod Dp	VCF Cutoff	Resonance
50	Sync Eko	Pd	Poly		Techno-C		Sync Pitch	FM Depth	VCF Cutoff	Resonance
51	Sharpsyn	Pd	Poly		TekkEchoB		Sync Picth	VCO1 Edge, VCO2 Edge	VCF Cutoff	Resonance
52	SyncEko2	Pd	Poly		Techno-C		Sync Pitch	FM Depth	VCF Cutoff	Resonance
53	Vangelzm	Pd	Poly		UpDwAOct2		Sync Pitch	VCF Mod Dp	HPF Cutoff	VCF Cutoff
54	Mars	Pd	Poly		UpDwBOct2		Sync Pitch	VCA Mod Dp	VCO1 Edge, VCO2 Edge	LFO2 Speed
55	WaterPad	Pd	Poly		RandmOct4		Sync Pitch	VCF Mod Dp	PEG Decay	Resonance
56	HighSwep	Pd	Poly		UpOct1		Sync Pitch	VCF Mod Dp	LFO2 Speed	VCF Cutoff
57	SyncSwep	Pd	Poly		UpOct1		Sync Pitch	VCO2 Level	VCF Cutoff	Resonance
58	Mountain	Pd	Poly		UpOct1		VCO1 Mix	FEG Attack	VCF Cutoff	Resonance
59	FunnyLFO	Fx	Poly		RandmOct2		Dist. Dry/Wet	LFO1 Speed	Portmnt Time	VCF Cutoff
60	Phenomna	Fx	Poly		RandmOct2		VCA Feedback	Portmnt Time	VCF Cutoff	Resonance
61	AN Track	Fx	Poly		UpOct2		FEG Sustain	VCF Mod Dp	VCF Cutoff	Resonance

No.	VoiceName	Category	Key Assign		Pattern Generator		AN AC1	AN AC2	AN AC3	AN AC4
			Mode	Unison	Type	Switch	(Default CC#41)	(Default CC#42)	(Default CC#43)	(Default CC#44)
62	BPF Pad	Fx	Poly		UpOct1		FEG Sustain	VCF Mod Dp	VCF Cutoff	Resonance
63	X Bells	Fx	Poly		StepSEQ		VCO1 Edge	VCO2 Edge	VCA Feedback	VCF Cutoff
64	ResoBell	Fx	Poly		UpOct4		VCO2 X-Mod Dp	VCF Mod Dp	VCO1 Level	Noise Level
65	Triangle	Fx	Poly		BassLineA		VCO1 Detune	VCO2 X-Mod Dp	VCF Cutoff	Resonance
66	XmodBell	Fx	Poly		UpOct2		VCO2 X-Mod Dp	VCF Mod Dp	VCF Cutoff	Resonance
67	Saphire	Fx	Poly		StepSEQ		Sync Pitch	Dist. Dry/Wet	PEG Depth	HPF Cutoff
68	Ropey	Fx	Legato	On	StepSEQ		Sync Pitch	FM Depth	Dist. Dry/Wet, VCA Volume	HPF Cutoff
69	SepaWays	Fx	Poly		Techno-A		VCO1 Edge	VCO2 PW	VCO2 Level	VCF Cutoff
70	DeepBlue	Fx	Poly		UpOct1		VCO1 Edge, VCO2 Edge	Sync Pitch Dp, FM Depth, VCF Mod Dp	VCA Feedback	HPF Cutoff
71	Ice Pad	Fx	Poly		RandmOct2		VCO2 Level	Noise Level	VCF Cutoff	Resonance
72	Jah	Fx	Poly		StepSEQ		Sync Pitch	VCF Mod Dp	VCO1 Edge, VCO2 Edge	LFO1 Speed
73	Polaris	Fx	Poly		UpOct1		Sync Pitch	VCO1 Edge, VCO2 Edge	LFO1 Speed	HPF Cutoff, VCA Feedback
74	Microdot	Fx	Poly		UpOct1		VCO1 Edge, VCO2 Edge	VCA Mod Dp	LFO2 Speed	HPF Cutoff
75	Snowball	Fx	Poly		StepSEQ		FEG Attack	VCF Mod Dp	VCO1 Level	VCO2 Level
76	Syncrome	Fx	Poly		BassLineD		Sync Pitch	Dist. Dry/Wet	LFO1 Speed	VCF Cutoff
77	RhthmCty	Fx	Poly		UpOct1		Sync Pitch	VCF Mod Dp	FEG Depth	Portmnt Time
78	Slalom	Fx	Poly		UpOct1		Dist. Dry/Wet	VCF Mod Dp	VCA Volume	LFO2 Speed
79	SyncSitr	Fx	Poly		SyncopaA		Dist. Dry/Wet	VCO1 Level	FEG Attack, AEG Attack	FEG Decay
80	Dragnfly	Fx	Poly		UpOct1		Sync Pitch	VCO1 Edge	LFO1 Speed	HPF Cutoff
81	DownUndr	Fx	Poly		DwOct4		FEG Attack	HPF Cutoff	VCF Cutoff	Resonance
82	Indosync	Fx	Poly		RandmOct2		Sync Pitch	VCO1 Edge	FEG Decay	HPF Cutoff
83	ANBeltre	Pc	Poly		UpOct2		VCO1 Detune	VCO2 X-Mod Dp	FEG Decay	VCF Cutoff
84	Woob	Pc	Poly		RandmOct2		VCO1 Edge, VCO2 Edge	VCO1 Level	HPF Cutoff	VCF Cutoff
85	ANCowbel	Pc	Poly		BassLineC		VCO1 Edge	VCO1 PW	VCF Cutoff	Resonance
86	TriblTom	Dr	Poly		BassLineC		Dist. Dry/Wet	HPF Cutoff	VCF Cutoff	Resonance
87	AN Snare	Dr	Poly		BassLineC		FM Depth	VCO1 Edge	Noise Level	Dist. Dry/Wet
88	AN Toms	Dr	Poly		BassLineC		VCO1 Edge	VCF Mod Dp	VCF Cutoff	VCF Cutoff, Resonance
89	Tranix	Dr	Poly		BassLineC		Sync Pitch Dp	FM Depth	VCO2 Level	HPF Cutoff
90	Rimshot	Dr	Poly		BassLineC		Noise Level	VCF Mod Dp	VCF Cutoff	Resonance
91	XstikSnr	Dr	Poly		BassLineC		Noise Level	VCF Mod Dp	FEG Attack	FEG Decay
92	MufflKik	Dr	Poly		BassLineC		FEG Attack	VCF Mod Dp	FEG Decay	VCF Cutoff
93	Euro kik	Dr	Poly		BassLineC		FEG Attack	VCF Mod Dp	FEG Decay	VCF Cutoff
94	AN HiHat	Dr	Poly		StepSEQ		AEG Attack	AEG Decay	AEG Sustain	AEG Release
95	ANHioptr	Se	Poly		UpOct1		FEG Attack, AEG Attack	LFO1 Speed	HPF Cutoff	VCF Cutoff
96	Siren	Se	Poly		UpOct1		FEG Attack	AEG Release	LFO1 Speed	VCF Cutoff
97	RadioNz	Se	Poly		SyncopaA		Sync Pitch	VCF Mod Dp	FM Depth	PEG Decay
98	Chemicl2	Se	Poly		UpOct1		Sync Pitch	FM Depth	LFO1 Speed	HPF Cutoff
99	PropProp	Se	Poly		UpOct1		Dist. Dry/Wet	Ring Mod	Noise Level	HPF Cutoff
100	WelcomBk	Se	Poly		StepSEQ		VCO2 PW, Noise Level	FM Depth	LFO1 Speed	PEG Decay
101	PlyChord	Se	Poly		UpOct1		Sync Pitch	Sync Pitch Dp	FM Depth	VCO2 Level
102	AN Cave	Se	Poly		UpOct1		Dist. Dry/Wet	FEG Depth	VCO1 Level	Noise Level
103	Invade 2	Se	Poly		UpOct1		Dist. Dry/Wet	LFO2 Speed	FEG Depth	FEG Attack
104	FM Waves	Se	Poly		SyncopaB		FM Depth	Portmnt Time	VCF Cutoff	Resonance
105	Moment	Se	Poly		DwOct4		Sync Pitch	VCF Mod Dp	Portmnt Time	HPF Cutoff
106	XScreech	Se	Legato		UpOct4		Dist. Dry/Wet	VCO2 X-Mod Dp	VCA Feedback	VCF Cutoff, Resonance
107	CybrClck	Sq	Poly		SyncopaA	On	Sync Pitch	VCF Mod Dp	Portmnt Time	HPF Cutoff
108	Earth	Sq	Poly		UpDwAOct2	On	Ring Mod	VCF Mod Dp	Noise Level	Portmnt Time
109	FreeRthm	Sq	Poly		UpOct1	On	FM Depth	VCA Feedback	Noise Level	VCF Cutoff
110	Quarks	Sq	Poly		StepSEQ	On	Sync Pitch, Sync Pitch Dp	VCO1 Edge, VCO2 Edge	VCA Feedback	Dist. Dry/Wet
111	OldOkt	Sq	Poly		StepSEQ	On	Dist. Dry/Wet	FEG Attack	FEG Decay	FEG Sustain
112	BPF Step	Sq	Poly		StepSEQ	On	Sync Pitch	Dist. Dry/Wet	FEG Attack	FEG Sustain
113	Poptart	Sq	Poly		StepSEQ	On	Sync Pitch	VCO2 Edge	FEG Attack	HPF Cutoff
114	Virtual	Sq	Poly		StepSEQ	On	Sync Pitch	VCO1 Edge	VCO1 PW	VCO2 Edge
115	Cactus	Sq	Mono		StepSEQ	On	Dist. Dry/Wet	Noise Level	FEG Attack	FEG Decay
116	Omega	Sq	Poly		StepSEQ	On	Dist. Dry/Wet	Noise Level	FEG Attack	FEG Decay
117	Seismic	Sq	Poly		StepSEQ	On	Dist. Dry/Wet	Noise Level	VCF Cutoff	Resonance
118	JarreSQ	Sq	Poly		StepSEQ	On	Sync Pitch	Sync Pitch Dp	FM Depth	VCO1 Edge, VCO2 Edge
119	TechPlck	Sq	Poly		StepSEQ	On	Sync Pitch	Sync Pitch Dp	FM Depth	VCO1 Edge
120	Krtwvks	Sq	Poly		StepSEQ	On	Dist. Dry/Wet	FEG Decay	VCF Cutoff	Resonance
121	Filtrfw	Sq	Poly		StepSEQ	On	VCO2 Level	FEG Decay	PEG Depth	VCF Cutoff
122	Dist5th	Sq	Poly		StepSEQ	On	Sync Pitch	VCO2 Level	FEG Decay	VCF Cutoff
123	HardNoiz	Sq	Poly		StepSEQ	On	Sync Pitch	Noise Level	FEG Sustain	VCF Cutoff
124	Lightstk	Sq	Legato		StepSEQ	On	VCO2 X-Mod Dp	FEG Attack, AEG Attack	FEG Sustain	VCO1 Edge, AEG Release
125	Lotus	Sq	Poly		DwOct2	On	VCO1 Edge	VCO2 X-Mod Dp	VCO2 Pmod Dp	Dist. Dry/Wet
126	Xalimba	Sq	Poly		StepSEQ	On	Sync Pitch	FM Depth	VCO1 Edge	PEG Decay
127	Uni Bass	Sq	Legato	On	StepSEQ	On	Dist. Dry/Wet	FEG Depth	VCF Cutoff	Resonance
128	Hrmsync2	Sq	Legato	On	StepSEQ	On	VCO1 Edge, VCO2 Edge	FEG Decay	VCA Feedback, HPF Cutoff	Portmnt Time

■ User Bank Voice List (factory bank from Preset 1/2)

Bank Select MSB=36, LSB=2

User No.	Preset 1/2	Preset No.	Voice Name	Category
1	1	39	Metallic	Sq
2	2	116	Omega	Sq
3	1	126	ElecGroV	Sq
4	2	112	BPF Step	Sq
5	1	1	Killer	Sq
6	1	37	Fat Run	Sq
7	2	120	Krftwrks	Sq
8	1	38	Power	Sq
9	1	119	Hardcore	Sq
10	2	122	Dist5th	Sq
11	2	123	HardNoiz	Sq
12	1	120	Kangaroo	Sq
13	1	123	Harmsync	Sq
14	1	121	AcidSeq1	Sq
15	2	127	Uni Bass	Sq
16	1	127	ANSeqBas	Sq
17	2	117	Seismic	Sq
18	1	124	KickLine	Sq
19	1	40	Zebedee	Sq
20	1	2	Cream	Ba
21	1	7	BiggMac	Ba
22	1	49	Slum	Ba
23	1	47	Prphtic2	Ba
24	1	4	Uni Saw	Ba
25	1	57	BirdWrld	Ba
26	1	48	Wonder	Ba
27	1	50	X-Bass	Ba
28	1	9	Insomnia	Ba
29	2	1	Cracker	Ba
30	2	4	Knives	Ba
31	1	3	2001	Ba
32	1	6	Squeaky	Ba
33	1	55	10thTone	Ba
34	1	66	Hardstep	Ba
35	1	8	Monty	Ba
36	1	62	Zed Bass	Ba
37	1	5	Ruff	Ba
38	1	59	RubbaBas	Ba
39	2	7	Mg Frlts	Ba
40	1	12	ANSyncLd	Ld
41	1	15	Faaaat	Ld
42	1	85	J.Hammer	Ld
43	1	14	Dre-full	Ld
44	1	13	Squeamer	Ld
45	1	10	Maise	Ld
46	1	81	P-5 Saw	Ld
47	1	78	Chick	Ld
48	1	67	Stevie	Ld
49	1	100	Funky	Ld
50	1	83	DirtySaw	Ld
51	1	11	Bombastc	Ld
52	1	17	Lipstick	Ld
53	1	103	Abacab	Ld
54	1	73	Lucky	Ld
55	1	87	PitchMan	Ld
56	1	75	X-mod	Ld
57	1	77	ANSyncHd	Ld
58	2	14	Cosmic	Ld
59	2	29	MiniTech	Ld
60	2	16	5th Ring	Ld
61	1	94	Pastel	Ld
62	2	13	Mg Cat	Ld
63	2	11	MgWhistl	Ld
64	1	102	AN VoxLd	Ld

User No.	Preset 1/2	Preset No.	Voice Name	Category
65	2	31	AsianTek	Ld
66	1	95	Chromes	Ld
67	1	18	HardBrss	Br
68	1	106	Fatty	Br
69	1	19	ToToHorn	Br
70	2	18	ObDetune	Br
71	2	24	ProBrass	Br
72	1	110	SlowBras	Br
73	1	20	So-Lina	St
74	1	21	MultiSaw	St
75	1	114	Lush	St
76	1	22	Contnent	Pd
77	1	23	PWMSweep	Pd
78	2	47	Soar	Pd
79	2	56	HighSwep	Pd
80	2	22	ProAtck2	Pd
81	2	51	Sharpsyn	Pd
82	2	57	SyncSwep	Pd
83	2	44	5th Pad	Pd
84	2	61	AN Track	Fx
85	2	62	BPF Pad	Fx
86	2	69	SepaWays	Fx
87	1	27	Fire	Fx
88	1	25	CyberBag	Fx
89	1	26	Unstable	Fx
90	2	82	Indosync	Fx
91	1	28	Jack	Fx
92	2	71	Ice Pad	Fx
93	2	59	FunnyLFO	Fx
94	2	80	Dragnfly	Fx
95	2	32	SeqWater	Fx
96	2	9	MgVoice	Fx
97	2	27	Behind 2	Fx
98	2	21	ProAttack	Fx
99	2	33	HarmoSq2	Fx
100	2	64	ResoBell	Fx
101	2	20	ObCembal	Pf
102	1	29	ULTSound	Dr
103	1	30	HiQ Reso	Pc
104	2	89	Tranix	Dr
105	2	34	AnaDrum	Dr
106	2	87	AN Snare	Dr
107	2	93	Euro kik	Dr
108	2	35	SynthTom	Dr
109	2	37	EthnoTom	Dr
110	2	39	EthTeck	Pc
111	2	94	AN HiHat	Dr
112	2	85	ANCowbel	Pc
113	2	36	SynShake	Dr
114	1	31	Fumble	Se
115	1	32	Invade	Se
116	1	33	FreeEdge	Se
117	1	35	Chemical	Se
118	1	36	AnalgAge	Se
119	1	34	Touch	Se
120	2	96	Siren	Se
121	2	97	RadioNz	Se
122	2	38	Contact	Se
123	2	105	Moment	Se
124	2	126	Xalimba	Sq
125	2	109	FreeRthm	Sq
126	2	113	Poptart	Sq
127	2	107	CybrClck	Sq
128	2	110	Quarks	Sq

• When the power is turned off and on again, the contents of the User memory are replaced by voices from Preset 1 and 2 banks in this list.

■ AN-XG Voice Map

Bank Select MSB = 84 (XG/A), 100 (XG/B)

Bank Select LSB		0	64	65	66	67	68	69	70	71	72	73	74	75	76
Instrument Group	Pgm#														
Bass	39	ANSynBas	RealMini	Chamleon	Cream	Maxx	2001	BlapMoth	Ruff	BiggMac	Prphtic1	Prphtic2	Wonder	Slum	
	40	FootBase	Mini Low	DuckBass	10thTone	DuckBas2	Cracker	Monty	BirdWrld	Woodbass	RubbaBas	Smooth	Smoovey	Zed Bass	Oizo
Strings	51	Analog	So-Lina	Chocolate	Stringer										
	52	Lush	Bonn	PWM Pad	MultiSaw	AnaStrng	StrngPad								
Ensemble	55	MaMa													
Brass	63	Fatty	MajorBrs	Bronze	HardBras										
	64	ANSofBr	CS80Bras	ToToHorn	SlowBras										
Synth Lead	81	Stevie	Pulsate	Silent	Maise	KnivesLd	Pulser	Sliver	Lucky	ANPopcrn					
	82	Caner	ANSyncHd	Chick	Susy	EarthLd	P-5 Saw	Rock It	Faaaat	DirtySaw	Rhubarb	J.Hammer	X-mod 2	PitchMan	EarthLd2
	83	ANCallop													
	84	AN Chiff	Pastel												
	85	ANSyncLd	Billy	Dre-full	Funky										
	86	AN VoxLd													
	87	Lipstick	Abacab												
	88	Squeamer	Mr. Hook	Suprsync											
Synth Pad	90	Magic	Contnent	Yellow	5th Pad	Kelp									
	91	SyncBrPd													
	92	Soar													
	93	AN Bowed													
	94	Sync Eko	Sharpsyn	SyncEko2											
	95	Vangelzm													
	96	PWMSweep	HighSweep	SyncSweep	Mountain										
Synth Effects	98	AN Track													
	99	X Bells	ResoBell	Triangle	XmodBell										
	100	Saphire													
	101	SepaWays													
	102	DeepBlue													
	103	Microdot	Snowball												
Percussive	104	Slalom	SyncSitr												
	113	ANBeltre													
	115	Woob													
	117	TriblTom													
	119	SynthTom	ULTSound	AN Toms	Tranix										
	120	AN HiHat													

• Bank Select MSB = 84 : Empty areas of the columns produce no sound (Silence).

• Bank Select MSB = 100 : Empty areas of the columns produce the voice (Bank Select MSB = 0) of the XG Plug-in System device (MU128, etc.).

Voice List

Bank Select MSB = 84 (XG/A)

Bank Select LSB	0	64	65	66	67	68	69	70	71	72	73	74	75	76	
Instrument Group	Pgm#														
Sound Effects	126	ANHlcptr	Siren	RadioNz	Fumble	Invade	FreeEdge	Touch	Chemical	AnalgAge	Chemical2	PropProp	WelcomBk	PlyChord	AN Cave
Sequence	127	Hardcore	Kangaroo	AcidSeq1	AcidSeq2	Harmsync	KickLine	Free Cut	ElecGroV	ANSeqBas	Cool man	Uni Bass	Hrmsync2	Killer	CybrClck
	128	BPF Step	Poptart	Virtual	Cactus	Omega	Seismic	JarreSQ	TechPICK	Krftwrks	Filtrflw	Dist5th	HardNoiz	Lightstk	Lotus

Bank Select LSB	77	78	79	80	81	96	97	98	99	100	101	102	103	104	105	106	107
Instrument Group	Pgm#																
Sound Effects	126	Invade 2	FM Waves	Moment	Contact	Xscreech											
Sequence	127	Earth	FreeRthm	Quarks	OldOkt												
	128	Xalimba	Fat Run	Power	Metallic	Zebedee											

Bank Select LSB	96	97	98	99	100	101	102	103	104	105	106	107
Instrument Group	Pgm#											
Bass	39	X-Bass										
	40	Dog Bass	Squeaky	Insomnia	Stranger	Hardstep	Behind	Rydeen	Knives	Knives 2	Mg Wood	Mg Frlts
Strings	51											
	52	Hi Wedge										
Ensemble	55	MgVoice										
Brass	63	ObDetune	ProBrass									
	64											
Synth Lead	81	X-mod	MgSoloLd	Mg Cat								
	82	Cosmic	Q Lead	MiniTech								
	83	AsianTek										
	84	Synchrms										
	85	DistOdsy										
	86	MgVoice2										
	87	5th Ring										
	88											
Synth Pad	90	Loom										
	91	ProAtck2	Pro Sync									
	92											
	93	AN Dawn										
	94											
	95	Mars	Water Pad									
Synth Effects	96	Laos										
	98	BPF Pad										
	99											
	100	ProAtack	Behind 2	HarmoSq	HarmoSq2							
	101											
	102	Ice Pad	Jah	Polaris	CyberBag	SeqWater						
	103	Syncrome	RhthmCty	Jack								
	104	Fire	Dragnfly	Unstable	DownUndr	Indosync	Nz Power					
Percussive	113	EthTeck										
	115	ANCowbel										
	117	AN Snare	AnaDrum									
	119	Rimshot	XstikSnr	EthnoTom	SynShake							
	120											

• Empty areas of the columns produce no sound (Silence).

■ Plug-in Voice List (for CS6x, CS6R, S80)

No.	VoiceName	Category
1	Killer	Sq
2	Power	Sq
3	ElecGroV	Sq
4	HardNoiz	Sq
5	Zebedee	Sq
6	BPF Step	Sq
7	DirtySaw	Sc
8	Faaaat	Sc
9	X-mod	Sc
10	Cream	Ba
11	2001	Ba
12	Uni Saw	Ba
13	X-Bass	Ba
14	Ruff	Ba
15	Squeaky	Ba
16	BiggMac	Ba
17	Monty	Ba
18	Insomnia	Ba
19	Bombastc	Ld
20	ANSyncLd	Ld
21	Maise	Ld
22	Squeamer	Ld
23	Dre-full	Ld
24	VA Pig	Ld
25	Lipstick	Ld
26	HardBrss	Br
27	Fatty	Br
28	ToToHorn	Br
29	So-Lina	St
30	MultiSaw	St
31	Contnent	Pd
32	PWMSweep	Pd

No.	VoiceName	Category
33	Laos	Fx
34	CyberBag	Fx
35	Unstable	Fx
36	Fire	Fx
37	Jack	Fx
38	ULTSound	Dr
39	HiQ Reso	Pc
40	Fumble	Se
41	Invade	Se
42	FreeEdge	Se
43	Touch	Se
44	Chemical	Se
45	AnalgAge	Se
46	ANSynBas	Ba
47	Prphtic	Ba
48	DuckBass	Ba
49	Rydeen	Ba
50	Stranger	Ba
51	J.Hammer	Ld
52	Rock It	Ld
53	MgWhistl	Ld
54	ANSyncHd	Ld
55	On One	Ld
56	Indosync	Fx
57	RadioNz	Se
58	Invade 2	Se
59	Fat Run	Sq
60	Metallic	Sq
61	KickLine	Sq
62	Krftwrks	Sq
63	Seismic	Sq
64	Harmsync	Sq

■ Performance List (for MU128/100/100R)

No.	VoiceName	Category
1	Kraftworkers	Sq
2	Millennium	Sq
3	Metalwork	Sq
4	PsychoClock	Sq
5	2010	Ba
6	Bigger	Ba
7	Monticule	Ba
8	Knivez	Ba
9	Bomber	Ld
10	DoubleMaise	Ld
11	Rouge	Ld
12	Jump Brass	Br
13	MultiSawPad	St
14	ForcdStrings	St
15	Glassweep	Pd
16	Blue Wind	Pd
17	Mars Aurora	Pd
18	Laoscroll	Fx
19	RoundBells	Fx
20	Fire Pad	Fx
21	Microcosm	Fx
22	Ultra Drum	Dr
23	Cream	Ba
24	Smoovey	Ba
25	RuffRound	Ba
26	Squeaky	Ba
27	Insomnia	Ba
28	Slum	Ba
29	Funky	Ld
30	Squeamer	Ld
31	Dre-full	Ld
32	Faaaat	Ld

No.	VoiceName	Category
33	Abacab	Ld
34	MgWhistle	Ld
35	Pulser	Ld
36	ToToHorn	Br
37	So-Lina	St
38	Continent	Pd
39	ProSyncDist	Pd
40	in the Loom	Pd
41	SyncSweep	Pd
42	5th Pad	Pd
43	BPF Pad	Fx
44	Ice Pad	Fx
45	Sepaways	Fx
46	Jack	Fx
47	MgVoice2	Fx
48	ProAttack	Fx
49	Phenomina	Fx
50	Hi Q Reso	Pc
51	AnaDrum	Dr
52	Fumble	Se
53	Invade	Se
54	Free Edge	Se
55	Touchtones	Se
56	Chemical	Se
57	AnalogAge	Se
58	KillerLoop	Sq
59	Fat Run	Sq
60	Power Line	Sq
61	Zebedee	Sq
62	HyperNoise	Sq
63	Harmosync	Sq
64	Seismic	Sq

Tone Generator And Effect Signal Flow

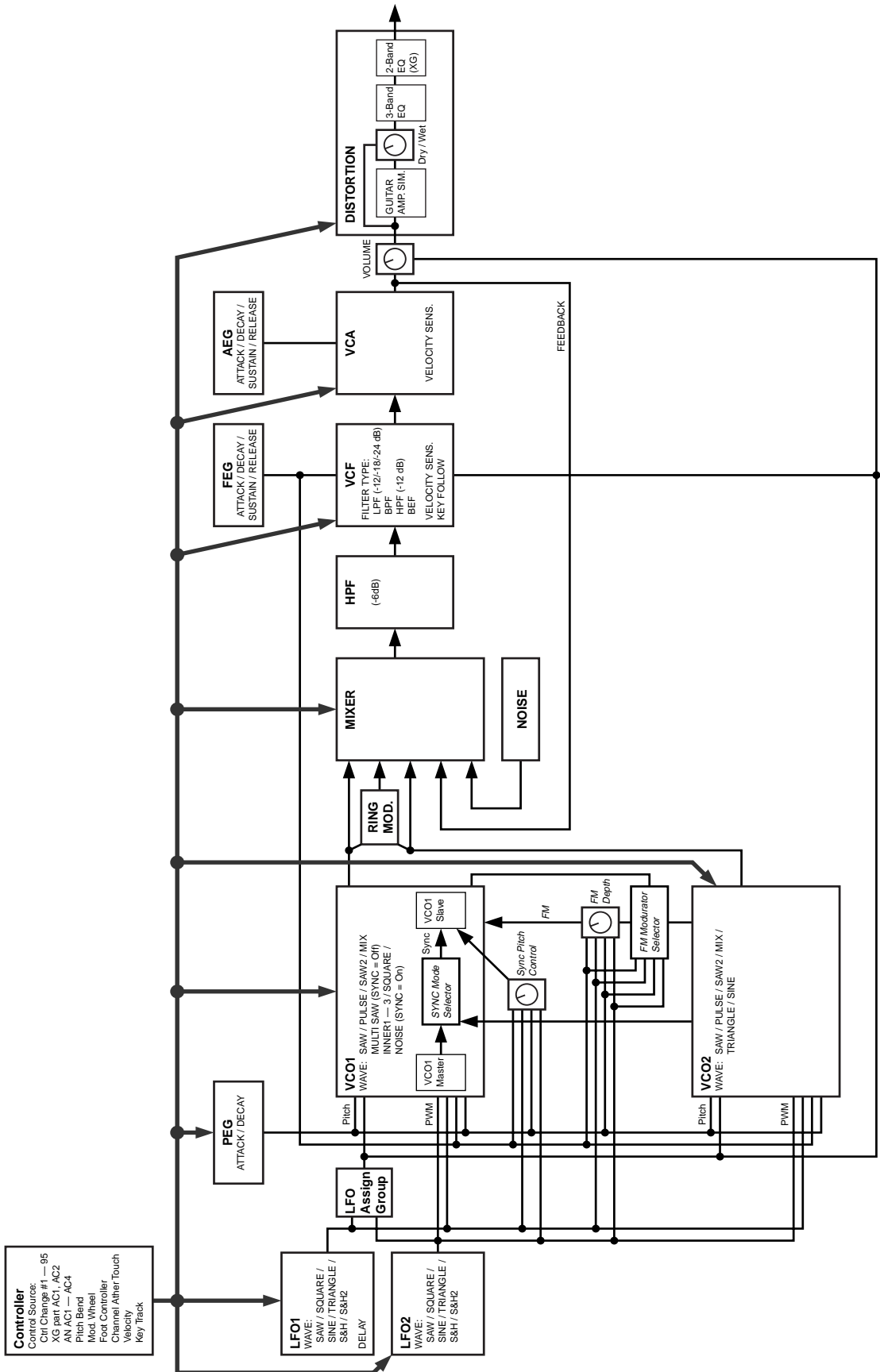

Arpeggio Type List

No.	Param Name	Comments
1	UpOct1	The chord (or phrase) ascends up 1 Octave.
2	UpOct2	The chord (or phrase) ascends up 2 Octaves.
3	UpOct4	The chord (or phrase) ascends up 4 Octaves.
4	DwnOct1	The chord (or phrase) descends down 1 Octave.
5	DwnOct2	The chord (or phrase) descends down 2 Octaves.
6	DwnOct4	The chord (or phrase) descends down 4 Octaves.
7	UpDwnAOct1	The chord (or phrase) ascends up 1 Octave, then descends.
8	UpDwnAOct2	The chord (or phrase) ascends up 2 Octaves, then descends.
9	UpDwnAOct4	The chord (or phrase) ascends up 4 Octaves, then descends.
10	UpDwnBOct1	The chord (or phrase) ascends up 1 Octave, then descends. (This is slightly different from type UpDwAOct1.)
11	UpDwnBOct2	The chord (or phrase) ascends up 2 Octaves, then descends. (This is slightly different from type UpDwAOct2.)
12	UpDwnBOct4	The chord (or phrase) ascends up 4 Octaves, then descends. (This is slightly different from type UpDwAOct4.)
13	RandmOct1	Plays up and down randomly over 1 Octave, based on the chord you play.
14	RandmOct2	Plays up and down randomly over 2 Octaves, based on the chord you play.
15	RandmOct4	Plays up and down randomly over 4 Octaves, based on the chord you play.
16	Techno-A	Typical techno sequence TYPE A. (Euro techno type.)
17	Techno-B	Typical techno sequence TYPE B. (UK type with Velocity.)
18	Techno-C	Typical techno sequence TYPE C. (Japan techno type.)
19	Techno-D	Typical techno sequence TYPE D. (German techno type.)
20	DAHouse	Backing sequence with House music feel. (Bass for left hand, Chord play for right hand.)
21	SyncopaA	Syncopation type sequence TYPE A.
22	SyncopaB	Syncopation type sequence TYPE B. (Octave moves considerably.)
23	Synco Echo	Syncopated type echo.
24	TekkEchoA	Echo with moving filter A.
25	TekkEchoB	Echo with moving filter B.
26	PulseLine	Sequence mixed with bass line and sequence line.
27	BassLineA	Arpeggio phrase TYPE A for bass.
28	BassLineB	Arpeggio phrase TYPE B for bass. (With Velocity.)
29	BassLineC	Arpeggio phrase TYPE C for bass.
30	BassLineD	Arpeggio phrase TYPE D for bass.

Control Matrix & Free EG Track Parameter List

Parameter Name		Ctrl Matrix : Parameter	Ctrl Matrix : Calc. Method	Ctrl Matrix : Source						Free EG : Trk Param
Group	Param Name	Data Value	Multiply or Add *1	CC AT	Data Range	Vel KeyRnd	Data Range	KeyTrk	Data Range	Data Value
---	off	0	---	---		---		---		0
---	Total Tune	1	add	x		O	(-64) - (+63)	x		
	Pitch Up	2	add	O	(-24) - (+24)	x		x		
	Pitch Down	3	add	O	(-24) - (+24)	x		x		
PEG	PEG Decay	4	add *2	O	(-64) - (+63)	O	(-64) - (+63)	O	(-64) - (+63)	1
	PEG Depth	5	mul	O	(-64) - (+63)	O	(-64) - (+63)	O	(-64) - (+63)	2
	PEG Switch			x		x		x		3
	Portmnt Time	6	add	O	(-64) - (+63)	O	(-64) - (+63)	O	(-64) - (+63)	4
LFO	LFO1 Wave			x		x		x		5
	LFO1 Speed	7	add	O	(-64) - (+63)	O	(-64) - (+63)	O	(-64) - (+63)	6
	LFO1 Delay	8	add	O	(-64) - (+63)	O	(-64) - (+63)	O	(-64) - (+63)	7
	LFO2 Speed	9	add	O	(-64) - (+63)	O	(-64) - (+63)	O	(-64) - (+63)	8
SYNC	Sync Mode			x		x		x		9
	Sync Pitch	10	add	O	(-64) - (+63)	O	(-64) - (+63)	O	(-32) - (+32)	10
	SyncPit Dp	11	mul	O	(-64) - (+63)	O	(-64) - (+63)	O	(-64) - (+63)	11
	Sync Pitch Src			x		x		x		12
	Sync Pmod Sw			x		x		x		13
FM	FM Depth	12	mul	O	(-64) - (+63)	O	(-64) - (+63)	O	(-64) - (+63)	14
	FM Source1			x		x		x		15
	FM Source2			x		x		x		16
VCO1	VCO1 Wave			x		x		x		17
	VCO1 Pitch	13	add	x		x		O	(-64) - (+63)	18
	VCO1 Fine	14	add	x		x		O	(-64) - (+63)	19
	VCO1 Edge	15	add	O	(-64) - (+63)	O	(-64) - (+63)	O	(-64) - (+63)	20
	PW1/Mix	16	add	O	(-64) - (+63)	x		x		21
	PWM1/Detune	17	mul	O	(-64) - (+63)	O	(-64) - (+63)	O	(-64) - (+63)	22
	PWM1 Src			x		x		x		23
(LFO)	VCO1 Pmod Dp	18	add	O	(-63) - (+63)	x		x		24
VCO2	VCO2 Wave			x		x		x		25
	VCO2 Pitch	19	add	x		x		O	(-64) - (+63)	26
	VCO2 Fine	20	add	x		x		O	(-64) - (+63)	27
	VCO2 Edge	21	add	O	(-64) - (+63)	O	(-64) - (+63)	O	(-64) - (+63)	28
	PW2	22	add	O	(-64) - (+63)	x		x		29
	PWM2/Xmod Dp	23	mul	O	(-64) - (+63)	O	(-64) - (+63)	O	(-64) - (+63)	30
	PWM2/Xmod Src			x		x		x		31
(LFO)	VCO2 Pmod Dp	24	add	O	(-63) - (+63)	x		x		32
MIXER	VCO1 Lvl	25	mul	O	(-64) - (+63)	O	(-64) - (+63)	O	(-64) - (+63)	33
	VCO2 Lvl	26	mul	O	(-64) - (+63)	O	(-64) - (+63)	O	(-64) - (+63)	34
	Ring Mod Lvl	27	mul	O	(-64) - (+63)	O	(-64) - (+63)	O	(-64) - (+63)	35
	Noise Lvl	28	mul	O	(-64) - (+63)	O	(-64) - (+63)	O	(-64) - (+63)	36
VCF	FEG Attack	29	add *2	O	(-64) - (+63)	O	(-64) - (+63)	O	(-64) - (+63)	37
	FEG Decay	30	add *2	O	(-64) - (+63)	O	(-64) - (+63)	O	(-64) - (+63)	38
	FEG Sustain	31	add	O	(-64) - (+63)	x		x		39
	FEG Release	32	add *2	O	(-64) - (+63)	O	(-64) - (+63)	O	(-64) - (+63)	40
	HPF Cutoff	33	add	O	(-64) - (+63)	O	(-64) - (+63)	O	(-64) - (+63)	41
	VCF Type			x		x		x		42
	VCF Cutoff	34	add	O	(-64) - (+63)	O	(-64) - (+63)	(x)	VCF KeyTrk	43
	Resonance	35	add	O	(-64) - (+63)	O	(-64) - (+63)	O	(-64) - (+63)	44
	FEG Depth	36	mul	O	(-64) - (+63)	(Vel x) KeyRnd	FEG VelSns (-64) - (+63)	O	(-64) - (+63)	45
	FEG Vel Sens			x		x		x		46
	VCF Key Trk			x		x		x		47
(LFO)	VCF FMod Dp	37	add	O	(-64) - (+63)	x		x		48
VCA	AEG Attack	38	add *2	O	(-64) - (+63)	O	(-64) - (+63)	O	(-64) - (+63)	49
	AEG Decay	39	add *2	O	(-64) - (+63)	O	(-64) - (+63)	O	(-64) - (+63)	50
	AEG Sustain	40	add	O	(-64) - (+63)	x		x		51
	AEG Release	41	add *2	O	(-64) - (+63)	O	(-64) - (+63)	O	(-64) - (+63)	52
(MIXER)	VCA F.B.	42	mul	O	(-64) - (+63)	x		x		53
	VCA Volume	43	mul	O	(-64) - (+63)	(Vel x) KeyRnd	AEG VelSns (-64) - (+63)	O	(-64) - (+63)	54
	AEG Vel Sns			x		x		x		55
(LFO)	VCA Mod Dp	44	add	O	(-64) - (+63)	x		x		56
Dist.	Dry/Wet	45		O	(-64) - (+63)	x		x		---
PLG-AN	PEG Attack	46	add *2	O	(-64) - (+63)	O	(-64) - (+63)	O	(-64) - (+63)	57
	LFO2 Wave			x		x		x		58
	FM Algorithm			x		x		x		59

*1. The effect of the controller on the parameter value is either added or multiplied as indicated. Also, when two or more different controllers are simultaneously assigned and applied to the same parameter, the combined effect of the controllers on the parameter value follows the same rule (is either added or multiplied).

*2. For these parameters, positive values decrease the time, making the EG rate faster.

Parameter List (XG / Modular Synthesis Plug-in System)

Modular Synthesis Plug-in System	XG Plug-in System	(LCD of CS6x/CS6R/S80/etc.)
----------------------------------	-------------------	-----------------------------

(Common Parameter)

Parameter Name	Parameter Name	Group	Parameter
Volume	VOLUME	QED*Level	Vol
Pan	PAN	QED*Level	Pan
Reverb Send	REVERB SEND	QED*Level	RevSend
Chorus Send	CHORUS SEND	QED*Level	ChoSend
LPF Cutoff Frequency	LOW PASS FILTER CUTOFF FREQUENCY	QED*Filter	Cutoff
LPF Resonance	LOW PASS FILTER RESONANCE	QED*Filter	Reso
Attack Time	EG ATTACK TIME	QED*EG	Attack
Decay Time	EG DECAY TIME	QED*EG	Decay
Release Time	EG RELEASE TIME	QED*EG	Release
Pitch Bend Range	BEND PITCH CONTROL	CTL*Pitch	Pitch Bend
Portamento Switch	PORTAMENTO SWITCH	CTL*Pitch	Portamento
Portamento Time	PORTAMENTO TIME	CTL*Pitch	Time
Mono/Poly Mode	MONO/POLY MODE	GEN*Other	Mode
Same Note Number Key On Assign	SAME NOTE NUMBER KEY ON ASSIGN *1	GEN*Other	Assign

(Element Parameter)

Parameter Name	Parameter Name	Group	Parameter
Plug-in Board Voice Bank MSB	BANK SELECT MSB	PLG*Assign	Bank
Plug-in Board Voice Bank LSB	BANK SELECT LSB	PLG*Assign	Bank
Plug-in Board Voice Program Number	PROGRAM NUMBER	PLG*Assign	Number
Note Shift	NOTE SHIFT	PLG*Velocity	NoteSft
Velocity Sense Depth	VELOCITY SENSE DEPTH	PLG*Velocity	Depth
Velocity Sense Offset	VELOCITY SENSE OFFSET	PLG*Velocity	Offset
Pitch EG Initial Level	PITCH EG INITIAL LEVEL	PCH*PEG	InitLvl
Pitch EG Attack Time	PITCH EG ATTACK TIME	PCH*PEG	Attack
Pitch EG Release Level	PITCH EG RELEASE LEVEL *1	PCH*PEG	--Level
Pitch EG Release Time	PITCH EG RELEASE TIME *1	PCH*PEG	Release
LFO Rate	VIBRATO RATE	LFO Param	Speed
LFO Pitch Modulation Depth	VIBRATO DEPTH	LFO Param	PMod
LFO Delay	VIBRATO DELAY	LFO Param	Delay
HPF Cutoff Frequency	HIGH PASS FILTER CUTOFF FREQUENCY	QED*Filter	HPF
EQ Low Gain	EQ BASS GAIN	EQ*Param	LoGain
EQ High Gain	EQ TREBLE GAIN	EQ*Param	HiGain
EQ Low Frequency	EQ BASS FREQUENCY	EQ*Param	LoFreq
EQ High Frequency	EQ TREBLE FREQUENCY	EQ*Param	HiFreq

MW Filter Control	MW LOW PASS FILTER CONTROL	CTL*MW Control	Filter
MW LFO Pitch Modulation Depth	MW LFO PMOD DEPTH	CTL*MW Modulation	PMod
MW LFO Filter Modulation Depth	MW LFO FMOD DEPTH	CTL*MW Modulation	FMod
MW LFO Amplitude Modulation Depth	MW LFO AMOD DEPTH	CTL*MW Modulation	AMod
CAT Pitch Control	CAT PITCH CONTROL	CTL*AT Control	Pitch
CAT Filter Control	CAT LOW PASS FILTER CONTROL	CTL*AT Control	Filter
CAT LFO Pitch Modulation Depth	CAT LFO PMOD DEPTH	CTL*AT Modulation	PMod
CAT LFO Filter Modulation Depth	CAT LFO FMOD DEPTH	CTL*AT Modulation	FMod
CAT LFO Amplitude Modulation Depth	CAT LFO AMOD DEPTH	CTL*AT Modulation	AMod
AC1 Controller Number	AC1 CONTROLLER NUMBER	CTL*AC Control	Source
AC1 Filter Control	AC1 LOW PASS FILTER CONTROL	CTL*AC Control	Filter
AC1 LFO Pitch Modulation Depth	AC1 LFO PMOD DEPTH	CTL*AC Modulation	PMod
AC1 LFO Filter Modulation Depth	AC1 LFO FMOD DEPTH	CTL*AC Modulation	FMod
AC1 LFO Amplitude Modulation Depth	AC1 LFO AMOD DEPTH	CTL*AC Modulation	AMod

*1 : Changing the values of these parameters has no effect on the sound (even though the values change in the display).

MIDI Data Format

1. Channel messages

1.1 Note on/note off

These messages convey keyboard performance data.

Range of note numbers received = C-2...G8

Velocity range = 1...127 (Velocity is received only for note-on)

When the Multi Part parameter "Rcv NOTE MESSAGE" = OFF, that part will not receive these messages.

1.2 Control changes

These messages convey control operation information for volume or pan etc.

Their functions are differentiated by the control number (Ctrl#).

If the Multi Part parameter Rcv CONTROL CHANGE = OFF, that part will not receive control changes.

1.2.1 Bank Select

This message selects the voice bank.

Control#	Parameter	Data Range
0	Bank Select MSB	0...127
32	Bank Select LSB	0...127

The Bank Select data will be processed only after a Program Change is received, and then voice bank will change at that time. If you wish to change the voice bank as well as the voice, you must transmit Bank Select and Program Change messages as a set, in the following order: Bank Select MSB, LSB, and Program Change.

1.2.2 Modulation

This message is used primarily to control the depth of vibrato, but the depth of the following 6 types of effect can be controlled. The effect of this message can be changed by the following parameters.

* Multi Part Parameter

1. MW PITCH CONTROL
2. MW FILTER CONTROL
3. MW AMPLITUDE CONTROL
4. MW LFO PMOD DEPTH
5. MW LFO FMOD DEPTH
6. MW LFO AMOD DEPTH

By default, an LFO Pitch Modulation (PMOD) effect will apply.

Control#	Parameter	Data Range
1	Modulation	0...127

If the Multi Part parameter Rcv MODULATION = OFF, that part will not receive Modulation.

1.2.3 Portamento Time

This message controls the degree of Portamento (see 1.2.9).

Control#	Parameter	Data Range
5	Portamento Time	0...127

When Portamento is ON, this regulates the speed of the pitch change. A value of 0 is the shortest Portamento time, and 127 is the longest Portamento time.

1.2.4 Data Entry

This message sets the value of the parameter which was specified by RPN (see 1.2.17) and NRPN (see 1.2.16).

Control#	Parameter	Data Range
6	Data Entry MSB	0...127
38	Data Entry LSB	0...127

1.2.5 Main Volume

This message controls the volume of each part. (It is used to adjust the volume balance between parts.)

Control#	Parameter	Data Range
7	Main Volume	0...127

When the Multi Part parameter Rcv VOLUME = OFF, that part will not receive Main Volume. With a value of 0 there will be no sound, and a value of 127 will produce the maximum volume.

1.2.6 Panpot

This message controls the panning (stereo location) of each part.

Control#	Parameter	Data Range
10	Pan	0...64...127

When the Multi Part parameter Rcv PAN = OFF, that part will not receive Panpot. 0 is left, 64 is center, and 127 is right.

1.2.7 Expression

This message controls expression for each part. It is used to create volume changes during a song.

Control#	Parameter	Data Range
11	Expression	0...127

If the Multi Part parameter Rcv EXPRESSION = OFF, that part will not receive Expression.

1.2.8 Hold1

This message controls sustain pedal on/off.

Control#	Parameter	Data Range
64	Hold1	0...63, 64...127 (OFF, ON)

When this is ON, currently-sounding notes will continue to sound even if note-off messages are received. If the Multi Part parameter Rcv HOLD1 = OFF, that part will not receive Hold1.

1.2.9 Portamento

This message controls Portamento pedal on/off.

Control#	Parameter	Data Range
65	Portamento	0...63, 64...127 (OFF, ON)

When ON, Portamento produces a smooth glide connecting two notes of different pitch. The time over which the pitch changes is adjusted by Portamento Time (see 1.2.3). When the Multi Part Parameter MONO/POLY MODE = MONO, the tone will also change smoothly (legato) if Portamento = ON.

If the Multi Part parameter Rcv PORTAMENTO = OFF, that part will not receive Portamento.

* Rcv PORTAMENTO = OFF

1.2.10 Harmonic Content

This message adjusts the resonance of the filter that is specified for the sound.

Control#	Parameter	Data Range
71	Harmonic Content	0...64...127 (-64...0...+63)

Since this is a relative change parameter, it specifies an increase or decrease relative to 64. Higher values will produce a more distinctive sound.

For some sounds, the effective range may be less than the possible range of settings.

1.2.11 Release Time

This message adjusts the EG release time that was specified by the sound data.

Control#	Parameter	Data Range
72	Release Time	0...64... 127 (-64...0...+63)

Since this is a relative change parameter, it specifies an increase or decrease relative to 64. Increasing this value will lengthen the release time that follows a note-off.

1.2.12 Attack Time

This message adjusts the EG attack time that was specified by the sound data.

Control#	Parameter	Data Range
73	Attack Time	0...64... 127 (-64...0...+63)

Since this is a relative change parameter, it specifies an increase or decrease relative to 64. Increasing this value will make the attack more gradual, and decreasing this value will make the attack sharper.

1.2.13 Brightness

This message adjusts the cutoff frequency of the low pass filter specified by the sound data.

Control#	Parameter	Data Range
74	Brightness	0...64...127 (-64...0...+63)

Since this is a relative change parameter, it specifies an increase or decrease relative to 64. Lower values will produce a more mellow sound.

For some sounds, the effective range may be less than the possible range of settings.

1.2.14 Decay Time

This message adjusts the EG decay time that was specified by sound data.

Control#	Parameter	Data Range
75	Decay Time	0...64...127 (-64...0...+63)

Since this is a relative change parameter, it specifies an increase or decrease relative to 64.

It determines how long it takes for the sound changes from maximum level to sustain level.

1.2.15 Data Increment/Decrement (for RPN)

This message is used to increment or decrement values for parameters specified by RPN (see 1.2.17), in steps of 1.

Control#	Parameter	Data Range
96	RPN Increment	—
97	RPN Decrement	—

The data byte is ignored.

MIDI Data Format

1.2.16 NRPN (Non-registered parameter number)

This is a message for setting the sound for things like vibrato, filter or EG. Use NRPN MSB and NRPN LSB to specify the parameter that you wish to modify, and then use Data Entry (see 1.2.4) to set the value for the specified parameter.

Control#	Parameter	Data Range
98	NRPN LSB	0...127
99	NRPN MSB	0...127

If the Multi Part parameter Rcv NRPN = OFF, that part will not receive NRPN.

The following NRPN messages can be received.

NRPN MSB	NRPN LSB	Data Entry *1 MSB	Data Entry *1 LSB	Parameter Name and Data Range
01H	08H	mm	--*2	Vibrato rate mm: 00H - 40H - 7FH (-64 ...0...+63)
01H	09H	mm	--	Vibrato depth mm: 00H - 40H - 7FH (-64 ...0...+63)
01H	0AH	mm	--*3	Vibrato delay mm: 00H - 40H - 7FH (-64 ...0...+63)
01H	20H	mm	--	Low pass filter cutoff frequency mm: 00H - 40H - 7FH (-64 ...0...+63)
01H	24H	mm	--	High pass filter cutoff frequency mm: 00H - 40H - 7FH (-64 ...0...+63)
01H	30H	mm	--	EQ bass gain mm: 00H - 40H - 7FH (-64 ...0...+63)
01H	31H	mm	--	EQ treble gain mm: 00H - 40H - 7FH (-64 ...0...+63)
01H	34H	mm	--	EQ bass frequency mm: 04H - 28H (32 ... 2.0K [Hz])
01H	35H	mm	--	EQ treble frequency mm: 1CH - 3AH (500 ... 16.0K [Hz])
01H	63H	mm	--	EG Attack Time mm: 00H - 40H - 7FH (-64 ...0...+63)
01H	64H	mm	--	EG Decay Time mm: 00H - 40H - 7FH (-64 ...0...+63)
01H	66H	mm	--	EG Release Time mm: 00H - 40H - 7FH (-64 ...0...+63)

*1 See 1.2.4

*2 "--" means that the set value will be ignored.

*3 Adjusts the time after the note is played until vibrato begins to take effect. The effect will begin more quickly for lower values, and more slowly for higher values.

1.2.17 RPN (Registered parameter number)

This message is used to specify part parameters such as Pitch Bend Sensitivity or Tuning. Use RPN MSB and RPN LSB to specify the parameter that you wish to modify, and then use Data Entry (see 1.2.4) to set the value of the specified parameter.

Control#	Parameter	Data Range
100	RPN LSB	0 ... 127
101	RPN MSB	0 ... 127

If the Multi Part parameter Rcv RPN = OFF, that part will not receive this message.

The following RPN messages can be received.

RPN MSB	RPN LSB	Data Entry *1 MSB	Data Entry *1 LSB	Parameter Name and Value Range
00	00H	mm	--*2	Pitch bend sensitivity mm: 00-18H (0...+24 semitones) Specify up to 2 octaves in semitone steps
00	01H	mm	ll	Fine tuning mm ll: 00H 00H -100 cents : : mm ll: 40H 00H 0 cents : : mm ll: 7FH 7FH +100 cents Note: The next after mm ll: 00H 7FH (= -87.5) cent is 01H 00H (-87.4) cents.
00H	02H	mm	--	Coarse tuning mm: 28H - 40H - 58H (-24...0...+24 semitones)
7FH	7FH	--	--	RPN Null This empties settings from RPN and NRPN numbers. Internal data is not affected.

*1 Refer to 1.2.4

*2 "--" means that the set value will be ignored.

1.2.18 Assignable controller

By assigning a control change number of 0...95 to a part, application of effects can be controlled. This device allows two control change numbers (AC1 and AC2) to be specified for each part.

The following parameters specify the effect of AC1 and AC2:

* Multi Part Parameter

1. AC1, AC2 PITCH CONTROL
2. AC1, AC2 FILTER CONTROL
3. AC1, AC2 AMPLITUDE CONTROL
4. AC1, AC2 LFO PMOD DEPTH
5. AC1, AC2 LFO FMOD DEPTH
6. AC1, AC2 LFO AMOD DEPTH

The AC1 control change number is specified by the Multi Part parameter AC1 CONTROLLER NUMBER, and the AC2 control change number is specified by the Multi Part parameter AC2 CONTROLLER NUMBER.

1.3 Channel mode messages

These messages specify the basic operation of a part.

1.3.1 All Sound Off

This message silences all notes being played on the corresponding channel. However, channel messages such as Note-on and Hold-on will be maintained in their present state.

Control#	Parameter	Data Range
120	All Sound Off	0

1.3.2 Reset All Controllers

This message changes the settings of the following controllers.

Controller	Value
Pitch bend change	±0 (Center)
Channel pressure	0 (OFF)
Modulation	0 (OFF)
Expression	127 (Max.)
Hold	0 (OFF)
Portamento	0 (OFF)
RPN	Number unset, internal data is not affected.
NRPN	Number unset, internal data is not affected.

The following data is not changed

Parameter values specified for program change, bank select MSB/LSB, volume, pan, effect send levels 1, 3, 4, RPN and NRPN.

Control#	Parameter	Data Range
121	Reset All Controllers	0

1.3.3 All Note Off

This message turns off all notes which are currently on for the corresponding part.

However, if Hold 1 or Sustain are on, notes will continue to sound until these are turned off.

Control#	Parameter	Data Range
123	All Note Off	0

1.3.4 Omni Off

Works the same as when All Note Off is received.

Control#	Parameter	Data Range
124	Omni Off	0

1.3.5 Omni On

Works the same as when All Note Off is received.

Control#	Parameter	Data Range
125	Omni On	0

1.3.6 Mono

Works the same as when All Sound Off is received, and if the value (mono number) is in the range of 0... 16, sets the corresponding channel to Mode4* (m = 1).

Control#	Parameter	Data Range
126	Mono	0 ... 16

* Mode4 is a state in which only channel messages on the specified channel will be received, and notes will be played individually (monophonically).

1.3.7 Poly

Works the same as when All Sound Off is received, and sets the corresponding channel to Mode3*.

Control#	Parameter	Data Range
127	Poly	0

* Mode3 is when channel messages will be received only on the specified channel, and notes will be sounded polyphonically.

1.4 Program change

This message is used to switch voices. It changes the program number on the receiving channel. When the change is to include the voice bank, transmit the program change after sending the Bank Select message (see 1.2.1). If the Multi Part parameter Rcv PROGRAM CHANGE = OFF, that part will not receive program changes.

1.5 Pitch bend

This message conveys information on pitch bend operations. Basically, this message is for changing the pitch of a part, but the depth of the following six effects can be controlled. The effect of this message can be modified by the following parameters.

- * Multi Part Parameter
- 1. BEND PITCH CONTROL
- 2. BEND FILTER CONTROL
- 3. BEND AMPLITUDE CONTROL
- 4. BEND LFO PMOD DEPTH
- 5. BEND LFO FMOD DEPTH
- 6. BEND LFO AMOD DEPTH

By default, the Pitch Control effect is applied. If the Multi Part parameter Rcv PITCH BEND CHANGE = OFF, that part will not receive pitch bend messages.

1.6 Channel aftertouch

This message conveys the pressure after the key is played on the keyboard (for an entire MIDI channel). The pressure can be controlled for each part. This message will affect the notes currently playing.

The effect of this message can be modified by the following parameters.

- * Multi Part Parameter
- 1. CAT PITCH CONTROL
- 2. CAT FILTER CONTROL
- 3. CAT AMPLITUDE CONTROL
- 4. CAT LFO PMOD DEPTH
- 5. CAT LFO FMOD DEPTH
- 6. CAT LFO AMOD DEPTH

By default, there will be no effect. If the Multi Part parameter Rcv CHANNEL AFTER TOUCH = OFF, that part will not receive Channel Aftertouch.

2. System exclusive messages

2.1 Parameter changes

- This device uses the following parameter changes.
- [UNIVERSAL REALTIME MESSAGE]
 - 1) Master Volume
 - [UNIVERSAL NON REALTIME MESSAGE]
 - 1) General MIDI System On
 - [DX1 PARAMETER CHANGE]
 - 1) DX1 Master Tuning
 - [XG PARAMETER CHANGE]
 - 1) XG System on
 - 2) XG System parameter change
 - 3) Multi Part parameter change
 - 4) PLG150-AN Part Assign parameter change
 - [PLG150-AN NATIVE PARAMETER CHANGE]
 - 1) PLG150-AN System parameter change
 - 2) PLG150-AN Part parameter change
 - 3) AN1x System parameter change
 - 4) Current Voice Common parameter change
 - 5) Current Voice Scene parameter change
 - 6) Current Voice Step Seq. Patten parameter change

2.1.1 Universal realtime messages

2.1.1.1 Master Volume

11110000	F0H	= Exclusive status
01111111	7FH	= Universal Real Time
01111111	7FH	= ID of target device
00001000	04H	= Sub-ID #1=Device Control Message
00000001	01H	= Sub-ID #2=Master Volume
* 0sssssss	SSH	= Volume LSB
0ttttttt	TTH	= Volume MSB
11110111	F7H	= End of Exclusive
or		
11110000	F0H	= Exclusive status
01111111	7FH	= Universal Real Time
0xxxxnnn	XNH	= Device Number, xxx = don't care
00001000	04H	= Sub-ID #1=Device Control Message
00000001	01H	= Sub-ID #2=Master Volume
0sssssss	SSH	= Volume LSB
0ttttttt	TTH	= Volume MSB
11110111	F7H	= End of Exclusive

When received, the Volume MSB is reflected in the System Parameter MASTER VOLUME.

* The binary expression 0sssssss is expressed in hexadecimal as SSH. The same applies elsewhere.

2.1.2 Universal non-realtime messages

2.1.2.1 General MIDI System On

11110000	F0H	= Exclusive status
01111110	7EH	= Universal Non-Real Time
01111111	7FH	= ID of target device
00001001	09H	= Sub-ID #1=General MIDI Message
00000001	01H	= Sub-ID #2=General MIDI On
11110111	F7H	= End of Exclusive
or		
11110000	F0H	= Exclusive status
01111110	7EH	= Universal Non-Real Time
0xxxxnnn	XNH	= N:Device Number, X:don't care
00001001	09H	= Sub-ID #1=General MIDI Message
00000001	01H	= Sub-ID #2=General MIDI On
11110111	F7H	= End of Exclusive

When this message is received, the XG parameters are initialized. Since approximately 50ms is required to process this message, be sure to allow an appropriate interval before sending the next message.

2.1.3 DX1 MASTER TUNING

11110000	F0H	Exclusive status
01000011	43H	YAMAHA ID
0001nnnn	1NH	N:device Number
00000100	04H	
01000000	40H	
0vvvvvvv	VVH	Data
11110111	F7H	End of Exclusive

The DX1-compatible messages are received, and the Master Tune of the AN1x System Data is changed. The value of VV is used as the MIDI master tuning parameter. VV = -64(00H) — 0(40H) — +63(7FH)

2.1.4 XG Parameter Change

This message sets XG-related parameters. Each message can set a single parameter. The message format is as follows.

11110000	F0H	Exclusive status
01000011	43H	YAMAHA ID
0001nnnn	1NH	N:device Number
01001100	4CH	Model ID
0ggggggg	GGH	Address High
0mmmmmmm	MMH	Address Mid
01111111	LLH	Address Low
0vvvvvvv	VVH	Data
:	:	
11110111	F7H	End of Exclusive

For parameters whose Data Size is 2 or 4, the appropriate amount of data will be transmitted as indicated by Size.

2.1.4.1 XG System On

11110000	F0H	Exclusive status
01000011	43H	YAMAHA ID
0001nnnn	1NH	N:device Number
01001100	4CH	Model ID
00000000	00H	Address High
00000000	00H	Address Mid
01111110	7EH	Address Low
00000000	00H	Data
11110111	F7H	End of Exclusive

When ON is received, the XG parameters are initialized. Since approximately 50ms is required to process this message, be sure to allow an appropriate interval before sending the next message.

2.1.4.2 XG System parameter change

This message sets the XG SYSTEM block (see Tables <1-1> and <1-2>).

2.1.4.3 Multi Part parameter change

This message sets the Multi Part block (see Tables <1-1> and <1-3>).

2.1.4.4 Part Assign parameter change

This message sets the part assigned to PLG150-AN (see Tables <1-1> and <1-4>).

2.1.5 PLG150-AN Native parameter change

This message sets parameters unique to the PLG150-AN. Each message can set a single parameter. The message format is as follows.

11110000	F0H	Exclusive status
01000011	43H	YAMAHA ID
0001nnnn	1NH	N:Device Number
01011100	5CH	Model ID
0ggggggg	GGH	Address High
0mmmmmmm	MMH	Address Mid
01111111	LLH	Address Low
0vvvvvvv	VVH	Data
:	:	:
11110111	F7H	End of Exclusive

For parameters whose Data Size is 2 or 4, the appropriate amount of data will be transmitted as indicated by Size.

2.1.5.1 PLG150-AN Native System parameter change

This message sets the PLG150-AN SYSTEM block (see Tables <2-1> and <2-2>).

2.1.5.2 PLG150-AN Native Part parameter change

This message sets the PLG150-AN MULTI PART block (see Tables <2-1> and <2-3>).

2.1.5.3 AN1x System parameter change

This message sets the PLG150-AN original System block (see Tables <2-1> and <2-4>).

2.1.5.4 Current Common parameter change

This message sets the Common block of the voice is sounding currently (see Tables <2-1> and <2-5>).

2.1.5.5 Current Scene parameter change

This message sets the Scene block of the voice is sounding currently (see Tables <2-1> and <2-6>).

2.1.5.6 Current Step SEQ Pattern parameter change

This message sets the Step SEQ block of the voice is sounding currently (see Tables <2-1> and <2-7>).

2.2 Bulk dump

This device uses only the following bulk dump messages.

[XG BULK DUMP]

- 1) XG System bulk dump
- 2) Multi Part bulk dump

[PLG150-AN NATIVE BULK DUMP]

- 1) PLG150-AN Native System bulk dump
- 2) PLG150-AN Native Part bulk dump
- 3) AN1x Sytem bulk dump
- 4) Current Common bulk dump
- 5) Current Scene bulk dump
- 6) Current Step Seq Pattern bulk dump
- 7) User Step Seq Pattern
- 8) User Voice

And the following bulk dump messages are received and changed as data of the PLG150-AN.

[AN1x BULK DUMP]

- 1) AN1x Sytem bulk dump
- 2) AN1x Current Common bulk dump
- 3) AN1x Current Scene bulk dump
- 4) AN1x Current Step Seq Pattern bulk dump
- 5) AN1x User Step Seq Pattern
- 6) AN1x User Voice

2.2.1 XG bulk dump

This message sets XG-related parameters. Unlike parameter change messages, a single message can modify multiple parameters. This message format is as follows.

11110000	F0H	Exclusive status
01000011	43H	YAMAHA ID
0000nnnn	0NH	N:Device Number
01001100	4CH	Model ID
0sssssss	SSH	ByteCountMSB
0ttttttt	TTH	ByteCountLSB
0ggggggg	GGH	Address High
0mmmmmmm	MMH	Address Mid
01111111	LLH	Address Low
0vvvvvvv	VVH	Data
:	:	:
0kkkkkkk	KKH	Check-sum
11110111	F7H	End of Exclusive

Address and Byte Count are given in tables <1-n>.

Byte Count is indicated by the total size of the Data in tables <1-n>.

Bulk dump is received when the beginning of the block is specified in "Address."

"Block" indicates the unit of the data string that is indicated in tables <1-n> as "Total Size."

Check sum is the value that produces a lower 7 bits of 0 when this Start Address, Byte Count, Data, and the Check sum itself are added.

2.2.1.1 XG System bulk dump

This message sets the XG SYSTEM block (see Tables <1-1> and <1-2>).

2.2.1.2 Multi Part bulk dump

This message sets the MULTI PART block (see Tables <1-1> and <1-3>).

2.2.2 PLG150-AN Native Bulk Dump

This message sets the special parameters for PLG150-AN.

Unlike Parameter change, one message can modify multiple parameters.

11110000	F0H	Exclusive status
01000011	43H	YAMAHA ID
0000nnnn	0NH	N:Device Number
01011100	5CH	Model ID
0sssssss	SSH	ByteCountMSB
0ttttttt	TTH	ByteCountLSB
0ggggggg	GGH	Address High
0mmmmmmm	MMH	Address Mid
01111111	LLH	Address Low
0vvvvvvv	VVH	Data
:	:	:
0kkkkkkk	KKH	Check-sum
11110111	F7H	End of Exclusive

The detail are the same as for 2.2.1 XG Bulk Dump. However, see Tables <2-n> for the Address, Byte, Count, and block.

2.2.2.1 PLG150-AN Naive System bulk dump

This message sets the PLG150-AN SYSTEM block (see Tables <2-1> and <2-2>).

2.2.2.2 PLG150-AN Native Part bulk dump

This message sets the PLG150-AN MULTI PART block (see Tables <2-1> and <2-3>).

2.2.2.3 AN1x System bulk dump

This message sets the PLG150-AN original System block (see Tables <2-1> and <2-4>).

2.2.2.4 Current Common bulk dump

This message sets the Common block of the voice is sounding currently (see Tables <2-1> and <2-5>).

2.2.2.5 Current Scene bulk dump

This message sets the Scene block of the voice is sounding currently (see Tables <2-1> and <2-6>).

2.2.2.6 Current Step Seq Pattern bulk dump

This message sets the Step SEQ block of the voice is sounding currently (see Tables <2-1> and <2-7>).

2.2.2.7 User Voice bulk dump

This message sets the PLG150-AN original User Voice block (see Tables <2-1> and <2-8>).

2.2.2.8 User Pattern bulk dump

This message sets the PLG150-AN original User Step Seq Pattern block (see Tables <2-1> and <2-9>).

2.2.3 AN1x bulk dump

The AN1x bulk dump messages are received and changed as data of the PLG150-AN.

11110000	F0H	Exclusive status
01000011	43H	YAMAHA ID
0000nnnn	0NH	N:Device Number
01011100	5CH	Model ID
0sssssss	SSH	ByteCountMSB
0ttttttt	TTH	ByteCountLSB
0ggggggg	GGH	Address High
0mmmmmm	MMH	Address Mid
01111111	LLH	Address Low
0vvvvvvv	VVH	Data
:	:	:
0kkkkkkk	KKH	Check-sum
11110111	F7H	End of Exclusive

The details are the same as for 2.2.1 XF Bulk Dump. However, see Table <3-1> for the Base address.

More details (Address, Byte Count, etc.), see the AN1x parameter list included with the AN1x.

2.2.3.1 AN1x System bulk dump

When the System block bulk data is received from the AN1x, the PLG150-AN responds to it.

The following parameters are reacted by the PLG150-AN.

- Keyboard Velocity Curve
- Keyboard Fixed Velocity
- Keyboard Transmit Channel
- Arpeggio/StepSEQ Transmit Channel
- Receive Channel 1
- Receive Channel 2
- Midi Device Number
- Midi Local

2.2.3.2 AN1x Current Common bulk dump

When the Common block bulk data of the voice sounds currently is received from the AN1x, the PLG150-AN responds to it (see the Table <3-1>).

The following parameters are invalid on the PLG150-AN, or affect differently compared with the ones applied to the AN1x.

- Scene Select (Always "Scene1" is fixed.)
- Layer Mode ("Single" or "Unison")
- Layer Pan, Layer Separation

Common Vtrl Matrix 1—2 Data (Source, Parameter, Depth)

Vari-Ef Type (Always "Guitar Amp.Simulator" is fixed.)

Dly-Ef, Rev-Ef Data (Type, Return, Parameter 1—7)

Arpeggio/StepSEQ Scene Sw. ("Off" or "On (only Scene1-side)")

FreeEG Track Scene Switch ("Off" or "On (only Scene1-side)")

2.2.3.3 AN1x Current Scene1 bulk dump

When the Scene1 block bulk data of the voice sounds currently is received from the AN1x, the PLG150-AN responds to it (see the Table <3-1>).

The following parameters are reacted by the PLG150-AN.
Ctrl Matrix 16 Data (Source, Parameter, Depth)

2.2.3.4 AN1x Current Step Seq Pattern bulk dump

When the Step SEQ block of the voice sounds currently is received from the AN1x, the PLG150-AN responds to it (see the Table <3-1>).

2.2.3.5 AN1x User Pattern bulk dump

When the User Step Seq Pattern block bulk data is received from the AN1x, the PLG150-AN responds to it (see the Table <3-1>).

2.2.3.6 AN1x User Voice bulk dump

When the User Voice block bulk data is received from the AN1x, the PLG150-AN responds to it (see the Table <3-1>).

The following parameters are invalid on the PLG150-AN, or affect differently compared with the ones applied to the AN1x.

- Data of Scene 2
- Common Data (See 2.2.3.2)
- Scene1 Data (See 2.2.3.3)

3. Realtime Messages

3.1 Active Sensing

- a) Send
This is not transmitted.
- b) Receive
After FE is received one time, if the MIDI signal does not come within 400 msec, PLG150-AN will act the same as when ALL SOUND OFF, ALL NOTE OFF, and RESET ALL CONTROLLERS are received, and return to the condition where has not been received once.

<1-1>

Parameter Base Address

MODEL ID = 4C

Parameter	Address			Description
	(H)	(M)	(L)	
XG SYSTEM	00	00	00	System
	00	00	7E	XG System On
	00	00	7F	All Parameter Reset
MULTI PART	08	00	00	Multi Part 1
	:	:	:	:
	08	0F	00	Multi Part 16
MULTI PART (additional)	0A	00	00	Multi Part 1
	:	:	:	:
	0A	0F	00	Multi Part 16
PART ASSIGN	70	03	nn	PLG150-AN Part Assign (nn = PLG150-AN serial number)

<1-2>

MIDI Parameter Change table (XG SYSTEM)

Address (H)	Size (H)	Data (H)	Parameter	Description	Default (H)
0 0 0	4	00 - 0F	MASTER TUNE	-102.4...0...+102.3[cent]	00 04 00 00
1		00 - 0F		1st bit3-0→bit15-12	
2		00 - 0F		2nd bit3-0→bit11-8	
3		00 - 0F		3rd bit3-0→bit7-4	
				4th bit3-0→bit3-0	
4	1	00 - 7F	MASTER VOLUME**	0...127	7F
5	1	00 - 7F	MASTER ATTENUATOR**	0...127	0
6	1	28 - 58	TRANSCOPE	-24...0...+24[semitones]	40
7D	1		NOT USED		
7E	1	0	XG SYSTEM ON	00=XG system ON (receive only)	—
7F	1	0	ALL PARAMETER RESET	00=ON (receive only)	—
TOTAL SIZE	7				

** Processed on the XG platform side (MU128, MU100, etc.)

MIDI Data Format

<1-3>

MIDI Parameter Change table (MULTI PART)

Address (H)	Size (H)	Data (H)	Parameter	Description	Default (H)
08 0p	00	1	NOT USED		--
	01	1	BANK SELECT MSB	0 - 127	00
	02	1	BANK SELECT LSB	0 - 127	00
	03	1	PROGRAM NUMBER	1 - 128	00
	04	1	Rev CHANNEL	ch1 - ch16,OFF	00
	05	1	MONO/POLY MODE	0:MONO,1:POLY	01
	06	1	NOT USED		--
	07	1	PART MODE	0:NORMAL	00
	08	1	NOTE SHIFT	-24 - +24[semitones]	40
	09	2	DETUNE	-12.8 - +12.7[Hz]	08 00
				1st bit3-0→bit7-4,2nd bit3-0→bit3-0	
	0B	1	VOLUME **	0 - 127	64
	0C	1	VELOCITY SENS DEPTH	0 - 127	40
	0D	1	VELOCITY SENS OFFSET	0 - 127	40
	0E	1	PAN **	CENTER(0),L63...C...R63(1...64...127)	40
	0F	1	NOTE LIMIT LOW	C-2 - G8	00
	10	1	NOTE LIMIT HIGH	C-2 - G8	7F
	11	1	DRY LEVEL **	0 - 127	7F
	12	1	CHORUS SEND **	0 - 127	00
	13	1	REVERB SEND **	0 - 127	28
	14	1	VARIATION SEND **	0 - 127	00
	15	1	VIBRATO RATE	-64 - +63	40
	16	1	VIBRATO DEPTH	-64 - +63	40
	17	1	VIBRATO DELAY	-64 - +63	40
	18	1	FILTER CUTOFF FREQUENCY	-64 - +63	40
	19	1	FILTER RESONANCE	-64 - +63	40
	1A	1	EG ATTACK TIME	-64 - +63	40
	1B	1	EG DECAY TIME	-64 - +63	40
	1C	1	EG RELEASE TIME	-64 - +63	40
	1D	1	MW PITCH CONTROL	-24 - +24[semitones]	40
	1E	1	MW FILTER CONTROL	-9600 - +9450[cent]	40
	1F	1	MW AMPLITUDE CONTROL **	-100 - +100[%]	40
	20	1	MW LFO PMOD DEPTH	0 - 127	0A
	21	1	MW LFO FMOD DEPTH	0 - 127	00
	22	1	MW LFO AMOD DEPTH	0 - 127	00
	23	1	BEND PITCH CONTROL	-24 - +24[semitones]	42
	24	1	BEND FILTER CONTROL	-9600 - +9450[cent]	40
	25	1	BEND AMPLITUDE CONTROL **	-100 - +100[%]	40
	26	1	BEND LFO PMOD DEPTH	0 - 127	00
	27	1	BEND LFO FMOD DEPTH	0 - 127	00
	28	1	BEND LFO AMOD DEPTH	0 - 127	00
TOTAL SIZE	29	29			
08 0p	30	1	Rev PITCH BEND	OFF/ON	01
	31	1	Rev CH AFTER TOUCH(CAT)	OFF/ON	01
	32	1	Rev PROGRAM CHANGE	OFF/ON	01
	33	1	Rev CONTROL CHANGE	OFF/ON	01
	34	1	NOT USED		--
	35	1	Rev NOTE MESSAGE	OFF/ON	01
	36	1	Rev RPN	OFF/ON	01
	37	1	Rev NRPN	OFF/ON	01
	38	1	Rev MODULATION	OFF/ON	01
	39	1	Rev MAIN VOLUME	OFF/ON	01
	3A	1	Rev PAN	OFF/ON	01
	3B	1	Rev EXPRESSION	OFF/ON	01
	3C	1	Rev HOLD1	OFF/ON	01
	3D	1	Rev PORTAMENTO	OFF/ON	01
	3E	1	NOT USED		--
	3F	1	NOT USED		--
	40	1	Rev BANK SELECT	OFF/ON	01
	41	1	NOT USED		--
	42	1	NOT USED		--
	43	1	NOT USED		--
	44	1	NOT USED		--
	45	1	NOT USED		--
	46	1	NOT USED		--
	47	1	NOT USED		--
	48	1	NOT USED		--
	49	1	NOT USED		--
	4A	1	NOT USED		--
	4B	1	NOT USED		--
	4C	1	NOT USED		--
	4D	1	CAT PITCH CONTROL	-24 - +24[semitones]	40
	4E	1	CAT FILTER CONTROL	-9600 - +9450[cent]	40
	4F	1	CAT AMPLITUDE CONTROL **	-100 - +100[%]	40
	50	1	CAT LFO PMOD DEPTH	0 - 127	00
	51	1	CAT LFO FMOD DEPTH	0 - 127	00
	52	1	CAT LFO AMOD DEPTH	0 - 127	00
	53	1	NOT USED		--
	54	1	NOT USED		--
	55	1	NOT USED		--
	56	1	NOT USED		--
	57	1	NOT USED		--
	58	1	NOT USED		--
	59	1	AC1 CONTROLLER NUMBER	off - 95	10

Address (H)	Size (H)	Data (H)	Parameter	Description	Default (H)
5A	1	28 - 58	AC1 PITCH CONTROL	-24 - +24[semitones]	40
5B	1	00 - 7F	AC1 FILTER CONTROL	-9600 - +9450[cent]	40
5C	1	00 - 7F	AC1 AMPLITUDE CONTROL **	-100 - +100[%]	40
5D	1	00 - 7F	AC1 LFO PMOD DEPTH	0 - 127	00
5E	1	00 - 7F	AC1 LFO FMOD DEPTH	0 - 127	00
5F	1	00 - 7F	AC1 LFO AMOD DEPTH	0 - 127	00
60	1	00 - 5F	AC2 CONTROLLER NUMBER	0 - 95	10
61	1	28 - 58	AC2 PITCH CONTROL	-24 - +24[semitone]	40
62	1	00 - 7F	AC2 LOW PASS FILTER CONTROL	-9600 - +9450[cent]	40
63	1	00 - 7F	AC2 AMPLITUDE CONTROL **	-100 - +100[%]	40
64	1	00 - 7F	AC2 LFO PMOD DEPTH	0 - 127	00
65	1	00 - 7F	AC2 LFO FMOD DEPTH	0 - 127	00
66	1	00 - 7F	AC2 LFO AMOD DEPTH	0 - 127	00
67	1	00 - 01	PORTAMENTO SWITCH	OFF/ON	00
68	1	00 - 7F	PORTAMENTO TIME	0 - 127	00
69	1	00 - 7F	PITCH EG INITIAL LEVEL (DEPTH)	-64 - +63	40
6A	1	00 - 7F	PITCH EG ATTACK/DECAY TIME	-64 - +63	40
6B	1		NOT USED		--
6C	1		NOT USED		--
6D	1	1 - 7F	VELOCITY LIMIT LOW	1 - 127	01
6E	1	1 - 7F	VELOCITY LIMIT HIGH	1 - 127	7F
TOTAL SIZE 3F					
08 0p	70	1	NOT USED		--
	71	1	NOT USED		--
	72	1	00 - 7F	EQ BASS GAIN	-12 - 12[dB]
	73	1	00 - 7F	EQ TREBLE GAIN	-12 - 12[dB]
TOTAL SIZE 4					
08 0p	74	1	NOT USED		--
	75	1	NOT USED		--
	76	1	04 - 28	EQ BASS FREQUENCY	32 - 2.0k[Hz]
	77	1	1C - 3A	EQ TREBLE FREQUENCY	500 - 16.0k[Hz]
	78	1		NOT USED	--
	79	1		NOT USED	--
	7A	1		NOT USED	--
	7B	1		NOT USED	--
	7C	1		NOT USED	--
	7D	1		NOT USED	--
	7E	1		NOT USED	--
	7F	1		NOT USED	--
TOTAL SIZE 0C					
0A 0p	20	1	00 - 7F	HIGH PASS FILTER CUTOFF FREQUENCY	-64 - +63
	21	1		NOT USED	--
TOTAL SIZE 2					

p = Part Number(0 - F)

** Processed on the XG platform side (MU128, MU100, etc.)

<1-4>

MIDI Parameter Change table (PART ASSIGN)

MIDI Parameter Change table (PART ASSIGN)					
Address (H)	Size (H)	Data (H)	Parameter	Description	Default (H)
70 03	nn	1	00 - 0F,7F	Part Assign	A1...A16, OFF
TOTAL SIZE 1					

nn = PLG150-AN Serial Number

<2-1>

Native Parameter Base Address

MODEL ID = 5C (AN1x)

Parameter	Address			Description
	(H)	(M)	(L)	
System	00	00	00	AN1x System
	00	08	00	PLG150-AN System
User Step Seq	01	00	00	User Step Seq Pattern 1
	:	:	:	:
	01	7F	00	User Step Seq Pattern 128
Part Param	09	00	00	PLG150-AN Native Part 1:
	:	:	:	:
	09	0F	00	PLG150-AN native Part 16
Curret Voice	10	00	00	Current Voice Common
	10	0E	00	Current Voice Step Seq Pattern
	10	10	00	Current Voice Scene
User Voice	20	00	00	User Voice 1
	:	:	:	:
	20	7F	00	User Voice 128

MIDI Data Format

<2-2>

MIDI Parameter Change table (PLG150-AN Native System)

Address (H)	Size (H)	Data (H)	Parameter	Description	Default (H)	
00 08	00	1	NOT USED		--	
	01	1	NOT USED		--	
	02	1	00-05	Velocity Curve	0:normal, 1:soft1, 2:soft2, 3:easy, 4:wide, 5:hard	00
	03	1	NOT USED		--	
	04	1	00-60	Morphing Ctrl No. (Morph off/on)	0:off, 1-95, 96:AT	00
	05	1	00-7F	Morphing to Program No.	0-127	00
	06	1	00-7F	Morphing to Bank Select LSB No.	0-127	00
	07	1	00-7F	Morphing to Bank Select MSB No.	36(0x24):Custom, 84(0x54):XG-a, 100(0x64):XG-b	0x24
	08	1	00-60	AN AC1 Ctrl Change No.	0:off, 1-95, 96:AT	0x29
	09	1	00-60	AN AC2 Ctrl Change No.	0:off, 1-95, 96:AT	0x2A
	0A	1	00-60	AN AC3 Ctrl Change No.	0:off, 1-95, 96:AT	0x2B
	0B	1	00-60	AN AC4 Ctrl Change No.	0:off, 1-95, 96:AT	0x2C
TOTAL SIZE	0C					

<2-3>

MIDI Parameter Change table (PLG150-AN Native Part)

Address (H)	Size (H)	Data (H)	Parameter	Description	Default (H)	
09 0p	00	1	00-01	Unison Off/On Switch	vce(0), off(1), on(2)	0
	01	1	00-01	Arpeggio/StepSEQ Off/On Switch	vce(0), off(1), on(2)	0
	02	2	00-7F	Tempo	vce(0), midi(39), 40-240	0
	04	1	00-7F	LFO2 Speed	-64 - +63	40
	05	1	00-7F	Sync Pitch	-64 - +63	40
	06	1	00-7F	FM Depth	-64 - +63	40
	07	1	00-7F	VCO Detune	-64 - +63	40
	08	1	00-7F	VCO1 Edge	-64 - +63	40
	09	1	00-7F	VCO1 Pulse Width	-64 - +63	40
	0A	1	00-7F	VCO1 PWM Depth	-64 - +63	40
	0B	1	00-7F	VCO2 Edge	-64 - +63	40
	0C	1	00-7F	VCO2 Pulse Width	-64 - +63	40
	0D	1	00-7F	VCO2 PWM Depth	-64 - +63	40
	0E	1	00-7F	Mixer VCO1 Level	-64 - +63	40
	0F	1	00-7F	Mixer VCO2 Level	-64 - +63	40
	10	1	00-7F	Mixer Ring Modulator Level	-64 - +63	40
	11	1	00-7F	Mixer Noise Level	-64 - +63	40
	12	1	00-7F	VCA Feedback Level	-64 - +63	40
	13	1	00-7F	VCF Filter Mod Depth	-64 - +63	40
	14	1	00-7F	FilterEG Depth	-64 - +63	40
	15	1	00-7F	FilterEG Attack Time	-64 - +63	40
	16	1	00-7F	FilterEG Decay Time	-64 - +63	40
	17	1	00-7F	FilterEG SustainLevel	-64 - +63	40
	18	1	00-7F	FilterEG Release Time	-64 - +63	40
	19	1	00-7F	VCA Amp Mod Depth	-64 - +63	40
	1A	1	00-7F	AmpEG Attack Time	-64 - +63	40
	1B	1	00-7F	AmpEG Decay Time	-64 - +63	40
	1C	1	00-7F	AmpEG Sustain Level	-64 - +63	40
	1D	1	00-7F	AmpEG Release Time	-64 - +63	40
	1E	1	00-7F	Distortion Gain	-64 - +63	40
	1F	1		NOT USED		--
	20	1	00-2E	AC1 Control Destination Param	off(0) - PEG Attack(2E)	00
	21	1	00-7F	AC1 Control Depth	Depends on Ctrl Matrix Param	40
TOTAL SIZE	22					

p = Part Number(0 - F)

<2-4>

MIDI Parameter Change table (AN1x System)

Address (H)	Size (H)	Data (H)	Parameter	Description	Default (H)	
00 00	00	2	0AE...352	Master tune	-98.9(0AE)...+98.9 cent(352)	200(+0)
	02	1		NOT USED		--
	03	1		NOT USED		--
	04	1		NOT USED		--
	05	1	00...04	Effect Bypass	off(0),all(4)	00(off)
	06	1		NOT USED		--
	07	1		NOT USED		--
	08	1		NOT USED		--
	09	1		NOT USED		--
	0a	1		NOT USED		--
	0b	1		NOT USED		--
	0c	1	00...60	Scene Ctrl Number	off(0),1...95,AT(60)	01(1)
	0d	1	00...60	MW Ctrl Number	off(0),1...95,AT(60)	01(1)
	0e	1	00...60	FV Ctrl Number	off(0),1...95,AT(60)	07(7)
	0f	1	00...60	FC Ctrl Number	off(0),1...95,AT(60)	04(4)
	10	1	00...60	FS Ctrl Number	off(0),1...95,AT(60)	40(64)
	11	1	00...60	Ribbon X Ctrl Number	off(0),1...95,AT(60)	0d(13)
	12	1	00...60	Ribbon Z Ctrl Number	off(0),1...95,AT(60)	0c(12)
	13	1	00...60	Assignable Ctrl 1 Number	off(0),1...95,AT(60)	28(41)
	14	1	00...60	Assignable Ctrl 2 Number	off(0),1...95,AT(60)	29(42)
	15	1	00...60	Assignable Ctrl 3 Number	off(0),1...95,AT(60)	2a(43)

Address (H)	Size (H)	Data (H)	Parameter	Description	Default (H)
16	1	00...60	Assignable Ctrl 4 Number	off(0),1...95,AT(60)	2b(44)
17	1	00...60	Assignable Ctrl 5 Number	off(0),1...95,AT(60)	2c(45)
18	1	00...60	Assignable Ctrl 6 Number	off(0),1...95,AT(60)	2d(46)
19	1	00...60	Assignable Ctrl 7 Number	off(0),1...95,AT(60)	2e(47)
1a	1	00...60	Assignable Ctrl 8 Number	off(0),1...95,AT(60)	2f(48)
1b	1		NOT USED		--
TOTAL SIZE	1C				

<2-5>

MIDI Parameter Change table (Current Voice Common Bufffer)

Address (H)	Size (H)	Data (H)	Parameter	Description	Default (H)
10 00 00	1	20...7F	Voice Name 1	Ascii Code	I
01	1	20...7F	Voice Name 2	Ascii Code	n
02	1	20...7F	Voice Name 3	Ascii Code	i
03	1	20...7F	Voice Name 4	Ascii Code	t
04	1	20...7F	Voice Name 5	Ascii Code	
05	1	20...7F	Voice Name 6	Ascii Code	V
06	1	20...7F	Voice Name 7	Ascii Code	c
07	1	20...7F	Voice Name 8	Ascii Code	e
08	1	20...7F	Voice Name 9	Ascii Code	
09	1	20...7F	Voice Name 10	Ascii Code	
0a	1	00...16	Voice Category	--,Pf...Wv	--
0b	1		NOT USED (AN1x : Scene Select)	Scene1(1) : fixed	1(scene1)
0c	1	00...01	Unison Sw. (AN1x : Layer Mode)	off(0),on(1)	00(off)
0d	1		NOT USED		--
0e	1		NOT USED		--
0f	1	01...20	Unison Detune	1...32	6
10	2	27...F0	Common Tempo	midi(27),40(28)...240(F0)	8C(140)
12	1	00...7F	Common Split Point	C-2(0)...G8(7F)	3C(C3)
13	1	00...01	Common Portamento Switch	off(0)...on(1)	00(off)
14	1		NOT USED		--
15	1		NOT USED		--
16	1		NOT USED		--
17	1		NOT USED		--
18	1		NOT USED		--
19	1		NOT USED		--
1a	1		NOT USED (AN1x : Var-Ef Type)	Guitar Amp.Simulator : fixed	0d (Amp.Sim.)
1b	1	00...02	Output Gain (AN1x : reserve)	+0dB(0), +6dB(1), +12dB(2)	00(+0dB)
1c	2	00...64	Gutar Amp.Simulator : Dist Drive	0...100	64(100)
1e	2	00...03	Gutar Amp.Simulator : Amp.Type	off(0) ,stack(1) ,combo(2) ,tube(3)	01(stack)
20	2	22...3C	Gutar Amp.Simulator : LPF	1.0k—Thru	30(5.0kHz)
22	2	00...64	Gutar Amp.Simulator : Dist Out Level	0—100	3c(60)
24	2		NOT USED		--
26	2		NOT USED		--
28	1	04...28	3-Band EQ Low Freq	32Hz(04)...2.0kHz(28)	11(140Hz)
29	1	34...4C	3-Band EQ Low Gain	-12dB(34)...0(40)...+12dB(76)	40(+0dB)
2a	1	0E...36	3-Band EQ Mid Freq	100Hz(0E)...10.0kHz(36)	28(2.0kHz)
2b	1	34...4C	3-Band EQ Mid Gain	-12dB(34)...0(40)...+12dB(4C)	40(+0dB)
2c	1	0A...78	3-Band EQ Mid Resonance(Q)	1.0(10)...12.0(78)	0A(1.0)
2d	1	1C...3A	3-Band EQ High Freq	500Hz(1C)...16.0kHz(3A)	34(8.0kHz)
2e	1	34...4C	3-Band EQ High Gain	-12dB(34)...0(40)...+12dB(4C)	40(+0dB)
2f	1		NOT USED		--
30	1		NOT USED		--
31	1		NOT USED		--
32	2		NOT USED		--
34	2		NOT USED		--
36	2		NOT USED		--
38	2		NOT USED		--
3a	2		NOT USED		--
3c	2		NOT USED		--
3e	2		NOT USED		--
40	1		NOT USED		--
41	1		NOT USED		--
42	2		NOT USED		--
44	2		NOT USED		--
46	2		NOT USED		--
48	2		NOT USED		--
4a	2		NOT USED		--
4c	2		NOT USED		--
4e	2		NOT USED		--
50	1	00...01	Arpeggio/StepSEQ On/Off Switch	off(0),on(1)	00(off)
51	1	00...01	Arpeggio/StepSEQ Select Switch	Arpeggio(0),Step Seq(1)	00(Arpeggio)
52	1	00...1D	Arpeggio/Type/StepSEQ Ptn No	UpDwn1(0)...BassLineD(1D)	*2 00(UpDwn1)
		00...7F		C#1:Usr001(0)...Usr128(7F)	*3
53	1	00...01	Arpeggio/StepSEQ Kbd Mode	chord(0),chord&normal(1)	*4 00(chord)
		00...03		normal(0),note-shift&normal(1),	*5
				ptn-sel&normal(2),pt-sel¬e-shift(3)	*6
54	1	00...01	Arpeggio/StepSEQ Hold	off(0),on(1)	00(off)
		00...02		off(0),mode1(1),mode2(2)	*3
55	1		NOT USED		--

MIDI Data Format

Address (H)	Size (H)	Data (H)	Parameter	Description	Default (H)
56	1	00...09	Arpeggio Subdivide	3/8(0)...1/32(9)	04(1/8)
57	1	32...53	Play Effect Swing	50%(32)...83%(53)	*5 32(50%)
58	2	00...C8	Play Effect Velocity	realtime(0),1%(1)...200%(C8)	64(100%)
5a	2	01...C8	Play Effect Gate Time	1%(1)...200%(C8)	*5 64(100%)
5c	1	00...02	Free EG Trigger	free(0),midi in notes(1),all notes(2)	01(midi in notes)
5d	1	00...04	Free EG Loop Type	off(0),forward(1),forward-half(2), alternate(3),alternate-half(4)	04(alternate-half)
5e	1	02...60	Free EG Length	1/2bar(2),1bar(3),3/2bars(4), 2bars(5),3bars(6),4bars(7),6bars(8), 8bars(9),1.0sec(0A)...8.0sec(50) ...16.0sec(60)	28(4.0sec)
5f	1	00...7F	Free EG Keyboard Track	-64...+63	40(+0)
60	1	00...3B	Free EG Trk Param 1	off(0)...FM Algorithm(3B)	*7 00(off)
61	1	00...01	Free EG Trk Scene Switch 1	off(0),on(1)	00(off)
62	1	00...3B	Free EG Trk Param 2	off(0)...FM Algorithm(3B)	*7 00(off)
63	1	00...01	Free EG Trk Scene Switch 2	off(0),on(1)	00(off)
64	1	00...3B	Free EG Trk Param 3	off(0)...FM Algorithm(3B)	*7 00(off)
65	1	00...01	Free EG Trk Scene Switch 3	off(0),on(1)	00(off)
66	1	00...3B	Free EG Trk Param 4	off(0)...FM Algorithm(3B)	*7 00(off)
67	1	00...01	Free EG Trk Scene Switch 4	off(0),on(1)	00(off)
68	2	00...01	Free EG Trk1 Data1 MSB	0...1	*8 1
		00...7F	Free EG Trk1 Data1 LSB	0...127	*8 0
6a	2	00...01	Free EG Trk1 Data2 MSB	0...1	*8 1
		00...7F	Free EG Trk1 Data2 LSB	0...127	*8 0
:	:	:			
03	66	2	00...01	Free EG Trk1 Data192 MSB	*8 1
			00...7F	Free EG Trk1 Data192 LSB	*8 0
03	68	2	00...01	Free EG Trk2 Data1 MSB	*8 1
			00...7F	Free EG Trk2 Data1 LSB	*8 0
03	6a	2	00...01	Free EG Trk2 Data2 MSB	*8 1
			00...7F	Free EG Trk2 Data2 LSB	*8 0
:	:	:			
06	66	2	00...01	Free EG Trk2 Data192 MSB	*8 1
			00...7F	Free EG Trk2 Data192 LSB	*8 0
06	68	2	00...01	Free EG Trk3 Data1 MSB	*8 1
			00...7F	Free EG Trk3 Data1 LSB	*8 0
06	6a	2	00...01	Free EG Trk3 Data2 MSB	*8 1
			00...7F	Free EG Trk3 Data2 LSB	*8 0
:	:	:			
09	66	2	00...01	Free EG Trk3 Data128 MSB	*8 1
			00...7F	Free EG Trk3 Data128 LSB	*8 0
09	68	2	00...01	Free EG Trk4 Data1 MSB	*8 1
			00...7F	Free EG Trk4 Data1 LSB	*8 0
09	6a	2	00...01	Free EG Trk4 Data2 MSB	*8 1
			00...7F	Free EG Trk4 Data2 LSB	*8 0
:	:	:			
0c	66	2	00...01	Free EG Trk4 Data128 MSB	*8 1
			00...7F	Free EG Trk4 Data128 LSB	*8 0

TOTAL SIZE 668

*1 : see other table(Arpeggio Type List)

*2 : see other table(Ctrl Matrix Parameter List)

*3 : become available only when Step Seq is selected and Kbd Mode='ptn-sel&norm' or 'ptn-sel¬e-shift'

*4 : only when Arpeggio is selected

*5 : only when Step Seq is selected

*6 : except *3

*7 : see other table (Free EG Track Paramter List)

*8 : only Bulk Dump (not received as parameter change)

<2-6>

MIDI Parameter Change table (Current Voice Scene Buffer)

Address (H)	Size (H)	Data (H)	Parameter	Description	Default (H)		
10	10	00	1	00...02	Key Assign Mode	poly(0),mono(1),legato(2)	00(poly)
		01	1	28...58	Pich Up (PB Range +)	-24(28)...+24(58)	42(+2)
		02	1	28...58	Pich Down (PB Range -)	-24(28)...+24(58)	3E(-2)
		03	1	00...7F	PEG Decay	0...127	0
		04	1	00...7F	PEG Depth	-64...+63 semitones	40(+0)
		05	1	01...03	PEG Switch	VCO(1),VCO(2),both(3)	03(both)
		06	1	00...01	Portamento Mode	normal(0),sustain-key(1) full-time(0),fingered(1)	*1 00(normal) *2
		07	1	00...7F	Portamento Time	0...127	2C(44)
		08	1	00...01	LFO Reset Mode	off(0),key-on(1)	00(off)
		09	1	00...14	LFO1 Wave	sine(0)...offset-s/h2(14)	00(sine)
		0a	2	00...FF	LFO1 Speed	1(0)...256(FF)	53(84)
		0c	1	00...7F	LFO1 Delay	0...127	0
		0d	2	00...FF	LFO2 Speed	1(0)...256(FF)	1F(32)
		0f	1	00...02	Sync Mode	off(0),vco1 master to slave(1), vco2 to vco1(2)	0(off)
		10	1	00...7F	Sync Pitch	-64...+63	40(+0)
		11	1	00...7F	Sync Pitch Depth	-64...+63	40(+0)
		12	1	00...04	Sync Pitch Source	fixed(0),PEG(1),FEG(2),LFO1(3), LFO2(4)	00(fixed)

Address (H)	Size (H)	Data (H)	Parameter	Description	Default (H)
13	1	01...03	Sync Pitch Mod Switch	master(1),slave(2),both(3)	*5 03(both)
14	1	00...7F	FM Depth	-64...+63	40(+0)
15	1	00...04	FM Source 1	fixed(0),PEG(1),FEG(2),LFO1(3),LFO2(4)	00(fixed)
16	1	00...07	FM Source 2	VCO2 freq(0),VCO1(1),VCO1-sub(2),PEG(3),FEG(4),LFO1(5),LFO2(6),VCO2 output(7)	00(VCO2 freq)
17	1	00...04	VCO1 Wave	saw(0),pulse(1),saw2(2),mix(3)	*3 00(saw)
		00...06	VCO1 Wave	multi-saw(4) saw(0),pulse(1),inner1(2),inner2(3),inner3(4),square(5),noise(6)	*4
18	1	00...7F	VCO1 Pitch Coarse	-64...+63 semitone	40(+0)
19	1	0E...72	VCO1 Pitch Fine	-50...+50 cent	40(+0)
1a	1	00...7F	VCO1 Edge	0...127	64(100)
1b	1	00...7F	VCO1 Pulse Width	0%(0)...50%(40)...99%(7F)	*7 40(50%)
		00...7F	VCO1 Mix	0...127	*8
1c	1	00...7F	VCO1 PWM Depth	-64...+63	*7 40(+0)
		00...7F	Detune	0...127	*8
1d	1	00...07	VCO1 PWM Source	fixed(0),PEG(1),FEG(2),LFO1(3),LFO2(4),LFO2-phase(5),LFO2-fast(6),VCO2(7)	*7 04(LFO2)
1e	2	01...FF	VCO1 Pitch Mod Depth	-127...+127	80(+0)
20	1	00...05	VCO2 Wave	saw(0),pulse(1),saw2(2),mix(3) triangle(4),sine(5)	00(saw)
21	1	00...7F	VCO2 Pitch Coarse	-64...+63 semitone	40(+0)
22	1	0E...72	VCO2 Pitch Fine	-50(0E)...+50 cent(72)	40(+0)
23	1	00...7F	VCO2 Edge	0...127	*9 7F(127)
24	1	00...7F	VCO2 Pulse Width	0%(0)...50%(40)...99%(7F)	*9 40(50%)
25	1	00...7F	VCO2 PWM Depth	-64...+63	*9 40(+0)
		00...7F	VCO2 X-MOD Depth	-64...+63	*10
26	1	00...07	VCO2 PWM Source	fixed(0),PEG(1),FEG(2),LFO1(3),LFO2(4),LFO2-phase(5),LFO2-fast(6),VCO1(7)	*9 04(LFO2)
		00...04	VCO2 X-MOD Source	fixed(0),PEG(1),FEG(2),LFO1(3),LFO2(4)	*10
27	2	01...FF	VCO2 Pitch Mod Depth	-127...+127	80(+0)
29	1	00...7F	Mixer VCO1 Level	0...127	7F(127)
2a	1	00...7F	Mixer VCO2 Level	0...127	0
2b	1	00...7F	Mixer Ring Mod Level	0...127	0
2c	1	00...7F	Mixer Noise Level	0...127	0
2d	1	00...7F	FilterEG Attack Time	0...127	0
2e	1	00...7F	FilterEG Decay Time	0...127	40(64)
2f	1	00...7F	FilterEG Sustain Level	0...127	7F(127)
30	1	00...7F	FilterEG Release Time	0...127	55(85)
31	1	00...7F	HPF Cutoff Freq	0(thru)...127	00(thru)
32	1	00...05	VCF Filter Type	LPF-24dB(0),LFP-18dB(1),LPF-12dB(2),BPF(3),HPF-12dB(4),BEF(5)	00(LPF-24dB)
33	1	00...7F	VCF Filter Cutoff	0...127	64(100)
34	1	0D...7F	VCF Filter Resonance	-12(0D)...0(19)...+102(7F)	19(+0)
35	2	00...FF	FilterEG Depth	-128...+127	A0(+32)
37	1	00...7F	FillrEG Velocity Sens	-64...+63	40(+0)
38	1	20...7F	VCF Keyboard Track	-32...+63	40(+0)
39	1	00...7F	VCF Filter Mod Depth	-64...+63	40(+0)
3a	1	00...7F	AmpEG Attack Time	0...127	0
3b	1	00...7F	AmpEG Decay Time	0...127	40(64)
3c	1	00...7F	AmpEG Sustain Level	0...127	7F(127)
3d	1	00...7F	AmpEG Release Time	0...127	24(36)
3e	1	00...7F	VCA Feedback Level	0...127	0
3f	1	00...7F	VCA Volume	0...127	69(105)
40	1	00...7F	AmpEG Velocity Sens	-64...+63	40(+0)
41	1	00...7F	VCA Amp Mod Depth	-64...+63	40(+0)
42	1	01...7F	Guitar Amp.Simulator Dry/Wet	D63>W(1)...D=W(40)...D<W63(7F)	01(D63>W)
43	1		NOT USED		--
44	1	00...72	Ctrl Matrix Source1	off(0)...Assign Knob8(72)	*6 0(off)
45	1	00...2E	Ctrl Matrix Param 1	off...PEG Attack(2E)	*6 0(off)
46	1	00...7F	Ctrl Matrix Depth 1	Depends on Ctrl Matrix Param	*6 40(+0)
47	1	00...72	Ctrl Matrix Source2	off(0)...Assign Knob8(72)	*6 0(off)
48	1	00...2E	Ctrl Matrix Param 2	off...PEG Attack(2E)	*6 0(off)
49	1	00...7F	Ctrl Matrix Depth 2	Depends on Ctrl Matrix Param	*6 40(+0)
4a	1	00...72	Ctrl Matrix Source3	off(0)...Assign Knob8(72)	*6 0(off)
4b	1	00...2E	Ctrl Matrix Param 3	off...PEG Attack(2E)	*6 0(off)
4c	1	00...7F	Ctrl Matrix Depth 3	Depends on Ctrl Matrix Param	*6 40(+0)
4d	1	00...72	Ctrl Matrix Source4	off(0)...Assign Knob8(72)	*6 0(off)
4e	1	00...2E	Ctrl Matrix Param 4	off...PEG Attack(2E)	*6 0(off)
4f	1	00...7F	Ctrl Matrix Depth 4	Depends on Ctrl Matrix Param	*6 40(+0)
50	1	00...72	Ctrl Matrix Source5	off(0)...Assign Knob8(72)	*6 0(off)
51	1	00...2E	Ctrl Matrix Param 5	off...PEG Attack(2E)	*6 0(off)
52	1	00...7F	Ctrl Matrix Depth 5	Depends on Ctrl Matrix Param	*6 40(+0)
53	1	00...72	Ctrl Matrix Source6	off(0)...Assign Knob8(72)	*6 0(off)
54	1	00...2E	Ctrl Matrix Param 6	off...PEG Attack(2E)	*6 0(off)
55	1	00...7F	Ctrl Matrix Depth 6	Depends on Ctrl Matrix Param	*6 40(+0)
56	1	00...72	Ctrl Matrix Source7	off(0)...Assign Knob8(72)	*6 0(off)
57	1	00...2E	Ctrl Matrix Param 7	off...PEG Attack(2E)	*6 0(off)
58	1	00...7F	Ctrl Matrix Depth 7	Depends on Ctrl Matrix Param	*6 40(+0)
59	1	00...72	Ctrl Matrix Source8	off(0)...Assign Knob8(72)	*6 0(off)
5a	1	00...2E	Ctrl Matrix Param 8	off...PEG Attack(2E)	*6 0(off)

MIDI Data Format

Address (H)	Size (H)	Data (H)	Parameter	Description	Default (H)
5b	1	00...7F	Ctrl Matrix Depth 8	Depends on Ctrl Matrix Param	*6 40(+0)
5c	1	00...72	Ctrl Matrix Source9	off(0)...Assign Knob8(72)	*6 0(off)
5d	1	00...2E	Ctrl Matrix Param 9	off...PEG Attack(2E)	*6 0(off)
5e	1	00...7F	Ctrl Matrix Depth 9	Depends on Ctrl Matrix Param	*6 40(+0)
5f	1	00...72	Ctrl Matrix Source10	off(0)...Assign Knob8(72)	*6 0(off)
60	1	00...2E	Ctrl Matrix Param 10	off...PEG Attack(2E)	*6 0(off)
61	1	00...7F	Ctrl Matrix Depth 10	Depends on Ctrl Matrix Param	*6 40(+0)
62	1	00...72	Ctrl Matrix Source11	off(0)...Assign Knob8(72)	*6 0(off)
63	1	00...2E	Ctrl Matrix Param 11	off...PEG Attack(2E)	*6 0(off)
64	1	00...7F	Ctrl Matrix Depth 11	Depends on Ctrl Matrix Param	*6 40(+0)
65	1	00...72	Ctrl Matrix Source12	off(0)...Assign Knob8(72)	*6 0(off)
66	1	00...2E	Ctrl Matrix Param 12	off...PEG Attack(2E)	*6 0(off)
67	1	00...7F	Ctrl Matrix Depth 12	Depends on Ctrl Matrix Param	*6 40(+0)
68	1	00...72	Ctrl Matrix Source13	off(0)...Assign Knob8(72)	*6 0(off)
6a	1	00...7F	Ctrl Matrix Depth 13	Depends on Ctrl Matrix Param	*6 40(+0)
6b	1	00...72	Ctrl Matrix Source14	off(0)...Assign Knob8(72)	*6 0(off)
6c	1	00...2E	Ctrl Matrix Param 14	off...PEG Attack(2E)	*6 0(off)
6d	1	00...7F	Ctrl Matrix Depth 14	Depends on Ctrl Matrix Param	*6 40(+0)
6e	1	00...72	Ctrl Matrix Source15	off(0)...Assign Knob8(72)	*6 0(off)
6f	1	00...2E	Ctrl Matrix Param 15	off...PEG Attack(2E)	*6 0(off)
70	1	00...7F	Ctrl Matrix Depth 16	Depends on Ctrl Matrix Param	*6 40(+0)
71	1		NOT USED		--
72	1		NOT USED		--
73	1		NOT USED		--
74	1		NOT USED		--
75	1	3E...42	Oct Shift	-2(3E), 0(40),+2(42)	*6 40(+0)
76	1	00...7F	PEG Attack	0...127	0
77	1	00...14	LFO2 Wave	sine(0)...offset-s/h2(14)	05(triangle)
78	1	00...0F	LFO Assign Group	VCO1(bit3),VCO2(bit2),VCA(bit1),VCF(bit0)	00(LFO1 to All)
79	1	01..03	FM Algorithm	both(1),master(2),slave(3)	*5 03(slave)
TOTAL SIZE	7A				

- *1 : Key Assign Mode = poly
- *2 : Key Assign Mode = mono,legato
- *3 : Oscillator Sync Mode = off
- *4 : Oscillator Sync Mode = on ('VCO1 master to slave' or 'VCO2 to VC1')
- *5 : Oscillator Sync Mode = 'VCO1 master to slave'
- *6 : see other table (Ctrl Matrix Parameter List)
- *7 : VCO1 Wave is not MultiSaw.
- *8 : VCO1 Wave is MultiSaw.
- *9 : VCO2 Wave is not Triangle or Sine.
- *10 : VCO1 Wave is Triangle or Sine.

<2-7>

MIDI Parameter Change table (Current Step Seq Buffer)

Address (H)	Size (H)	Data (H)	Parameter	Description	Default (H)
10 0e	00	1	00...09	Step Seq Base Unit	3/8(0)...1/32(9)
	01	1	01...10	Step Seq Length	1step(0)...16steps(10)
	02	1	00...03	Step Seq Loop Type	forward(0),backward(1),alternateA(2),alternateB(3)
	03	1	00...60	Step Seq Ctrl Change No	off(0)...95,AT(60)
	04	1		NOT USED	--
	05	1		NOT USED	--
	06	1	00...7F	Step Seq Note No 1	C-2(0)...G8(7F)
	07	1	00...7F	Step Seq Note No 2	C-2(0)...G8(7F)
	08	1	00...7F	Step Seq Note No 3	C-2(0)...G8(7F)
	09	1	00...7F	Step Seq Note No 4	C-2(0)...G8(7F)
	0a	1	00...7F	Step Seq Note No 5	C-2(0)...G8(7F)
	0b	1	00...7F	Step Seq Note No 6	C-2(0)...G8(7F)
	0c	1	00...7F	Step Seq Note No 7	C-2(0)...G8(7F)
	0d	1	00...7F	Step Seq Note No 8	C-2(0)...G8(7F)
	0e	1	00...7F	Step Seq Note No 9	C-2(0)...G8(7F)
	0f	1	00...7F	Step Seq Note No 10	C-2(0)...G8(7F)
	10	1	00...7F	Step Seq Note No 11	C-2(0)...G8(7F)
	11	1	00...7F	Step Seq Note No 12	C-2(0)...G8(7F)
	12	1	00...7F	Step Seq Note No 13	C-2(0)...G8(7F)
	13	1	00...7F	Step Seq Note No 14	C-2(0)...G8(7F)
	14	1	00...7F	Step Seq Note No 15	C-2(0)...G8(7F)
	15	1	00...7F	Step Seq Note No 16	C-2(0)...G8(7F)
	16	1	00...7F	Step Seq Velocity 1	rest(0),1...127
	17	1	00...7F	Step Seq Velocity 2	rest(0),1...127
	18	1	00...7F	Step Seq Velocity 3	rest(0),1...127
	19	1	00...7F	Step Seq Velocity 4	rest(0),1...127
	1a	1	00...7F	Step Seq Velocity 5	rest(0),1...127
	1b	1	00...7F	Step Seq Velocity 6	rest(0),1...127
	1c	1	00...7F	Step Seq Velocity 7	rest(0),1...127
	1d	1	00...7F	Step Seq Velocity 8	rest(0),1...127
	1e	1	00...7F	Step Seq Velocity 9	rest(0),1...127
	1f	1	00...7F	Step Seq Velocity 10	rest(0),1...127
	20	1	00...7F	Step Seq Velocity 11	rest(0),1...127
	21	1	00...7F	Step Seq Velocity 12	rest(0),1...127

Address (H)	Size (H)	Data (H)	Parameter	Description	Default (H)
22	1	00...7F	Step Seq Velocity 13	rest(0),1...127	100(64)
23	1	00...7F	Step Seq Velocity 14	rest(0),1...127	100(64)
24	1	00...7F	Step Seq Velocity 15	rest(0),1...127	100(64)
25	1	00...7F	Step Seq Velocity 16	rest(0),1...127	100(64)
26	1	00...7F	Step Seq Gate Time 1	1%(0)...100%(40)...200%(7F)	94%(3C)
27	1	00...7F	Step Seq Gate Time 2	1%(0)...100%(40)...200%(7F)	94%(3C)
28	1	00...7F	Step Seq Gate Time 3	1%(0)...100%(40)...200%(7F)	94%(3C)
29	1	00...7F	Step Seq Gate Time 4	1%(0)...100%(40)...200%(7F)	94%(3C)
2a	1	00...7F	Step Seq Gate Time 5	1%(0)...100%(40)...200%(7F)	94%(3C)
2b	1	00...7F	Step Seq Gate Time 6	1%(0)...100%(40)...200%(7F)	94%(3C)
2c	1	00...7F	Step Seq Gate Time 7	1%(0)...100%(40)...200%(7F)	94%(3C)
2d	1	00...7F	Step Seq Gate Time 8	1%(0)...100%(40)...200%(7F)	94%(3C)
2e	1	00...7F	Step Seq Gate Time 9	1%(0)...100%(40)...200%(7F)	94%(3C)
2f	1	00...7F	Step Seq Gate Time 10	1%(0)...100%(40)...200%(7F)	94%(3C)
30	1	00...7F	Step Seq Gate Time 11	1%(0)...100%(40)...200%(7F)	94%(3C)
31	1	00...7F	Step Seq Gate Time 12	1%(0)...100%(40)...200%(7F)	94%(3C)
32	1	00...7F	Step Seq Gate Time 13	1%(0)...100%(40)...200%(7F)	94%(3C)
33	1	00...7F	Step Seq Gate Time 14	1%(0)...100%(40)...200%(7F)	94%(3C)
34	1	00...7F	Step Seq Gate Time 15	1%(0)...100%(40)...200%(7F)	94%(3C)
35	1	00...7F	Step Seq Gate Time 16	1%(0)...100%(40)...200%(7F)	94%(3C)
36	1	00...7F	Step Seq CtrlChange Value 1	0...127	0(00)
37	1	00...7F	Step Seq CtrlChange Value 2	0...127	0(00)
38	1	00...7F	Step Seq CtrlChange Value 3	0...127	0(00)
39	1	00...7F	Step Seq CtrlChange Value 4	0...127	0(00)
3a	1	00...7F	Step Seq CtrlChange Value 5	0...127	0(00)
3b	1	00...7F	Step Seq CtrlChange Value 6	0...127	0(00)
3c	1	00...7F	Step Seq CtrlChange Value 7	0...127	0(00)
3d	1	00...7F	Step Seq CtrlChange Value 8	0...127	0(00)
3e	1	00...7F	Step Seq CtrlChange Value 9	0...127	0(00)
3f	1	00...7F	Step Seq CtrlChange Value10	0...127	0(00)
40	1	00...7F	Step Seq CtrlChange Value11	0...127	0(00)
41	1	00...7F	Step Seq CtrlChange Value12	0...127	0(00)
42	1	00...7F	Step Seq CtrlChange Value13	0...127	0(00)
43	1	00...7F	Step Seq CtrlChange Value14	0...127	0(00)
44	1	00...7F	Step Seq CtrlChange Value15	0...127	0(00)
45	1	00...7F	Step Seq CtrlChange Value16	0...127	0(00)
TOTAL SIZE			46		

<2-8>

MIDI Bulk Dump Parameter table (User Voice)

Address (H)	Size (H)	Data (H)	Parameter	Description	Default (H)
20 mm	00	1	Voice Name 1	Ascii Code	I
		1	Voice Name 2	Ascii Code	n
		1	Voice Name 3	Ascii Code	i
		1	Voice Name 4	Ascii Code	t
		1	Voice Name 5	Ascii Code	
		1	Voice Name 6	Ascii Code	V
		1	Voice Name 7	Ascii Code	c
		1	Voice Name 8	Ascii Code	e
		1	Voice Name 9	Ascii Code	
		1	Voice Name 10	Ascii Code	
		1	Voice Category	--,Pf...Wv	--
		1	NOT USED (AN1x : Scene Select)	Scene1(1) : fixed	1(scene1)
		1	Unison Sw. (AN1x : Layer Mode)	off(0),on(1)	00(off)
		1	NOT USED		--
		1	NOT USED		--
		1	Unison Detune	1...32	6
		2	Common Tempo	midi(27),40(28)...240(F0)	8C(140)
		1	Common Split Point	C-2(0)...G8(7F)	3C(C3)
		1	Common Portamento Switch	off(0)...on(1)	00(off)
		1	NOT USED		--
		1	NOT USED		--
		1	NOT USED		--
		1	NOT USED		--
		1	NOT USED		--
		1	NOT USED (AN1x : Var-Ef Type)	Guitar Amp.Simulator : fixed	0d (Amp.Sim.)
		1	Output Gain (AN1x : reserve)	+0dB(0), +6dB(1), +12dB(2)	00(+0dB)
		2	Gutar Amp.Simulator : Dist Drive	0...100	64(100)
		2	Gutar Amp.Simulator : Amp.Type	off(0) ,stack(1) ,combo(2) ,tube(3)	01(stack)
		2	Gutar Amp.Simulator : LPF	1.0kA^Thru	30(5.0kHz)
		2	Gutar Amp.Simulator : Dist Out Level	0A^100	3c(60)
		2	NOT USED		--
		2	NOT USED		--
		1	3-Band EQ Low Freq	32Hz(04)...2.0kHz(28)	11(140Hz)
		1	3-Band EQ Low Gain	-12dB(34)...0(40)...+12dB(76)	40(+0dB)
		1	3-Band EQ Mid Freq	100Hz(0E)...10.0kHz(36)	28(2.0kHz)
		1	3-Band EQ Mid Gain	-12dB(34)...0(40)...+12dB(4C)	40(+0dB)
		1	3-Band EQ Mid Resonance(Q)	1.0(10)...12.0(78)	0A(1.0)
		1	3-Band EQ High Freq	500Hz(1C)...16.0kHz(3A)	34(8.0kHz)
		1	3-Band EQ High Gain	-12dB(34)...0(40)...+12dB(4C)	40(+0dB)

MIDI Data Format

Address (H)	Size (H)	Data (H)	Parameter	Description	Default (H)
1			NOT USED		--
1			NOT USED		--
1			NOT USED		--
2			NOT USED		--
2			NOT USED		--
2			NOT USED		--
2			NOT USED		--
2			NOT USED		--
2			NOT USED		--
2			NOT USED		--
2			NOT USED		--
2			NOT USED		--
2			NOT USED		--
2			NOT USED		--
2			NOT USED		--
2			NOT USED		--
2			NOT USED		--
2			NOT USED		--
2			NOT USED		--
1	00...01		Arpeggio/StepSEQ On/Off Switch	off(0),on(1)	00(off)
1	00...01		Arpeggio/StepSEQ Select Switch	Arpeggio(0),Step Seq(1)	00(Arpeggio)
1	00...1D		ArpeggioType/StepSEQ Ptn No	UpDwn1(0)...BassLineD(1D)	*2 00(UpDwn1)
	00...7F			C#1:Usr001(0)...Usr128(7F)	*3
1	00...01		Arpeggio/StepSEQ Kbd Mode	chord(0),chord&normal(1)	*4 00(chord)
	00...03			normal(0),note-shift&normal(1),	*5
				ptn-sel&normal(2),pt-sel¬e-shift(3)	*6
1	00...01		Arpeggio/StepSEQ Hold	off(0),on(1)	00(off)
	00...02			off(0),mode1(1),mode2(2)	*3
1			NOT USED		--
1	00...09		Arpeggio Subdivide	3/8(0)...1/32(9)	04(1/8)
1	32...53		Play Effect Swing	50%(32)...83%(53)	*5 32(50%)
2	00...C8		Play Effect Velocity	realtime(0),1%(1)...200%(C8)	64(100%)
2	01...C8		Play Effect Gate Time	1%(1)...200%(C8)	*5 64(100%)
1	00...02		Free EG Trigger	free(0),midi in notes(1),all notes(2)	01(midi in notes)
1	00...04		Free EG Loop Type	off(0),forwardd(1),forwardd-half(2),	04(alternate-half)
				alternate(3),alternate-half(4)	
1	02...60		Free EG Length	1/2bar(2),1bar(3),3/2bars(4),	28(4.0sec)
				2bars(5),3bars(6),4bars(7),6bars(8),	
				8bars(9),1.0sec(0A)...8.0sec(50)	
				...16.0sec(60)	
1	00...7F		Free EG Keyboard Track	-64...+63	40(+0)
1	00...3B		Free EG Trk Param 1	off(0)...FM Algorithm(3B)	*7 00(off)
1	00...01		Free EG Trk Scene Switch 1	off(0),on(1)	00(off)
1	00...3B		Free EG Trk Param 2	off(0)...FM Algorithm(3B)	*7 00(off)
1	00...01		Free EG Trk Scene Switch 2	off(0),on(1)	00(off)
1	00...3B		Free EG Trk Param 3	off(0)...FM Algorithm(3B)	*7 00(off)
1	00...01		Free EG Trk Scene Switch 3	off(0),on(1)	00(off)
1	00...3B		Free EG Trk Param 4	off(0)...FM Algorithm(3B)	*7 00(off)
1	00...01		Free EG Trk Scene Switch 4	off(0),on(1)	00(off)
2	00...01		Free EG Trk1 Data1 MSB	0...1	*8 1
	00...7F		Free EG Trk1 Data1 LSB	0...127	*8 0
2	00...01		Free EG Trk1 Data2 MSB	0...1	*8 1
	00...7F		Free EG Trk1 Data2 LSB	0...127	*8 0
:					
2	00...01		Free EG Trk1 Data192 MSB	0...1	*8 1
	00...7F		Free EG Trk1 Data192 LSB	0...127	*8 0
2	00...01		Free EG Trk2 Data1 MSB	0...1	*8 1
	00...7F		Free EG Trk2 Data1 LSB	0...127	*8 0
2	00...01		Free EG Trk2 Data2 MSB	0...1	*8 1
	00...7F		Free EG Trk2 Data2 LSB	0...127	*8 0
:					
2	00...01		Free EG Trk2 Data192 MSB	0...1	*8 1
	00...7F		Free EG Trk2 Data192 LSB	0...127	*8 0
2	00...01		Free EG Trk3 Data1 MSB	0...1	*8 1
	00...7F		Free EG Trk3 Data1 LSB	0...127	*8 0
2	00...01		Free EG Trk3 Data2 MSB	0...1	*8 1
	00...7F		Free EG Trk3 Data2 LSB	0...127	*8 0
:					
2	00...01		Free EG Trk3 Data128 MSB	0...1	*8 1
	00...7F		Free EG Trk3 Data128 LSB	0...127	*8 0
2	00...01		Free EG Trk4 Data1 MSB	0...1	*8 1
	00...7F		Free EG Trk4 Data1 LSB	0...127	*8 0
2	00...01		Free EG Trk4 Data2 MSB	0...1	*8 1
	00...7F		Free EG Trk4 Data2 LSB	0...127	*8 0
:					
2	00...01		Free EG Trk4 Data128 MSB	0...1	*8 1
	00...7F		Free EG Trk4 Data128 LSB	0...127	*8 0
(from Here : User Voice Scene's Data)					
1	00...02		Key Assign Mode	poly(0),mono(1),legato(2)	00(poly)
1	28...58		Pich Up (PB Range +)	-24(28)...+24(58)	42(+2)
1	28...58		Pich Down (PB Range -)	-24(28)...+24(58)	3E(-2)
1	00...7F		PEG Decay	0...127	0
1	00...7F		PEG Depth	-64...+63 semitones	40(+0)

Address (H)	Size (H)	Data (H)	Parameter	Description	Default (H)
1	01...03		PEG Switch	VCO1(1),VCO2(2),both(3)	03(both)
1	00...01		Portamento Mode	normal(0),sustain-key(1) full-time(0),fingered(1)	*9 00(normal) *10
1	00...7F		Portamento Time	0...127	2C(44)
1	00...01		LFO Reset Mode	off(0),key-on(1)	00(off)
1	00...14		LFO1 Wave	sine(0)...offset-s/h2(14)	00(sine)
2	00...FF		LFO1 Speed	1(0)...256(FF)	53(84)
1	00...7F		LFO1 Delay	0...127	0
2	00...FF		LFO2 Speed	1(0)...256(FF)	1F(32)
1	00...02		Sync Mode	off(0),vco1 master to slave(1), vco2 to vco1(2)	0(off)
1	00...7F		Sync Pitch	-64...+63	40(+0)
1	00...7F		Sync Pitch Depth	-64...+63	40(+0)
1	00...04		Sync Pitch Source	fixed(0),PEG(1),FEG(2),LFO1(3), LFO2(4)	00(fixed)
1	01...03		Sync Pitch Mod Switch	master(1),slave(2),both(3)	03(both)
1	00...7F		FM Depth	-64...+63	40(+0)
1	00...04		FM Source 1	fixed(0),PEG(1),FEG(2),LFO1(3), LFO2(4)	00(fixed)
1	00...07		FM Source 2	VCO2 freq(0),VCO1(1),VCO1-sub(2), PEG(3),FEG(4),LFO1(5),LFO2(6),VCO2 output(7)	00(VCO2 freq)
1	00...04		VCO1 Wave	saw(0),pulse(1),saw2(2),mix(3) multi-saw(4)	*11 00(saw)
	00...06		VCO1 Wave	saw(0),pulse(1),inner1(2), inner2(3),inner3(4),square(5),noise(6)	*12
1	00...7F		VCO1 Pitch Coarse	-64...+63 semitone	40(+0)
1	0E...72		VCO1 Pitch Fine	-50...+50 cent	40(+0)
1	00...7F		VCO1 Edge	0...127	64(100)
1	00...7F		VCO1 Pulse Width	0%(0)...50%(40)...99%(7F)	*15 40(50%)
	00...7F		VCO1 Mix	0...127	*16
1	00...7F		VCO1 PWM Depth	-64...+63	*15 40(+0)
	00...7F		Detune	0...127	*16
1	00...07		VCO1 PWM Source	fixed(0),PEG(1),FEG(2), LFO1(3),LFO2(4),LFO2-phase(5), LFO2-fast(6),VCO2(7)	*15 04(LFO2)
2	01...FF		VCO1 Pitch Mod Depth	-127...+127	80(+0)
1	00...05		VCO2 Wave	saw(0),pulse(1),saw2(2),mix(3) triangle(4),sine(5)	00(saw)
1	00...7F		VCO2 Pitch Coarse	-64...+63 semitone	40(+0)
1	0E...72		VCO2 Pitch Fine	-50(0E)...+50 cent(72)	40(+0)
1	00...7F		VCO2 Edge	0...127	*17 7F(127)
1	00...7F		VCO2 Pulse Width	0%(0)...50%(40)...99%(7F)	*17 40(50%)
1	00...7F		VCO2 PWM Depth	-64...+63	*17 40(+0)
	00...7F		VCO2 X-MOD Depth	-64...+63	*18
1	00...07		VCO2 PWM Source	fixed(0),PEG(1),FEG(2), LFO1(3),LFO2(4),LFO2-phase(5), LFO2-fast(6),VCO1(7)	*17 04(LFO2)
	00...04		VCO2 X-MOD Source	fixed(0),PEG(1),FEG(2), LFO1(3),LFO2(4)	*18
2	01...FF		VCO2 Pitch Mod Depth	-127...+127	80(+0)
1	00...7F		Mixer VCO1 Level	0...127	7F(127)
1	00...7F		Mixer VCO2 Level	0...127	0
1	00...7F		Mixer Ring Mod Level	0...127	0
1	00...7F		Mixer Noise Level	0...127	0
1	00...7F		FilterEG Attack Time	0...127	0
1	00...7F		FilterEG Decay Time	0...127	40(64)
1	00...7F		FilterEG Sustain Level	0...127	7F(127)
1	00...7F		FilterEG Release Time	0...127	55(85)
1	00...7F		HPF Cutoff Freq	0(thru)...127	00(thru)
1	00...05		VCF Filter Type	LPF-24dB(0),LFP-18dB(1), LPF-12dB(2),BPF(3),HPF-12dB(4), BEF(5)	00(LPF-24dB)
1	00...7F		VCF Filter Cutoff	0...127	64(100)
1	0D...7F		VCF Filter Resonance	-12(0D)...0(19)...+102(7F)	19(+0)
2	00...FF		FilterEG Depth	-128...+127	A0(+32)
1	00...7F		FillrEG Velocity Sens	-64...+63	40(+0)
1	20...7F		VCF Keyboard Track	-32...+63	40(+0)
1	00...7F		VCF Filter Mod Depth	-64...+63	40(+0)
1	00...7F		AmpEG Attack Time	0...127	0
1	00...7F		AmpEG Decay Time	0...127	40(64)
1	00...7F		AmpEG Sustain Level	0...127	7F(127)
1	00...7F		AmpEG Release Time	0...127	24(36)
1	00...7F		VCA Feedback Level	0...127	0
1	00...7F		VCA Volume	0...127	69(105)
1	00...7F		AmpEG Velocity Sens	-64...+63	40(+0)
1	00...7F		VCA Amp Mod Depth	-64...+63	40(+0)
1	01...7F		Guitar Amp.Simulator Dry/Wet	D63>W(1)...D=W(40)...D<W63(7F)	01(D63>W)
1			NOT USED		--
1	00...72		Ctrl Matrix Source1	off(0)...Assign Knob8(72)	*14 0(off)
1	00...2E		Ctrl Matrix Param 1	off...PEG Attack(2E)	*14 0(off)
1	00...7F		Ctrl Matrix Depth 1	Depends on Ctrl Matrix Param	*14 40(+0)
1	00...72		Ctrl Matrix Source2	off(0)...Assign Knob8(72)	*14 0(off)
1	00...2E		Ctrl Matrix Param 2	off...PEG Attack(2E)	*14 0(off)
1	00...7F		Ctrl Matrix Depth 2	Depends on Ctrl Matrix Param	*14 40(+0)
1	00...72		Ctrl Matrix Source3	off(0)...Assign Knob8(72)	*14 0(off)
1	00...2E		Ctrl Matrix Param 3	off...PEG Attack(2E)	*14 0(off)

MIDI Data Format

Address (H)	Size (H)	Data (H)	Parameter	Description	Default (H)
1	1	00...7F	Ctrl Matrix Depth 3	Depends on Ctrl Matrix Param	*14 40(+0)
1	1	00...72	Ctrl Matrix Source4	off(0)...Assign Knob8(72)	*14 0(off)
1	1	00...2E	Ctrl Matrix Param 4	off...PEG Attack(2E)	*14 0(off)
1	1	00...7F	Ctrl Matrix Depth 4	Depends on Ctrl Matrix Param	*14 40(+0)
1	1	00...72	Ctrl Matrix Source5	off(0)...Assign Knob8(72)	*14 0(off)
1	1	00...2E	Ctrl Matrix Param 5	off...PEG Attack(2E)	*14 0(off)
1	1	00...7F	Ctrl Matrix Depth 5	Depends on Ctrl Matrix Param	*14 40(+0)
1	1	00...72	Ctrl Matrix Source6	off(0)...Assign Knob8(72)	*14 0(off)
1	1	00...2E	Ctrl Matrix Param 6	off...PEG Attack(2E)	*14 0(off)
1	1	00...7F	Ctrl Matrix Depth 6	Depends on Ctrl Matrix Param	*14 40(+0)
1	1	00...72	Ctrl Matrix Source7	off(0)...Assign Knob8(72)	*14 0(off)
1	1	00...2E	Ctrl Matrix Param 7	off...PEG Attack(2E)	*14 0(off)
1	1	00...7F	Ctrl Matrix Depth 7	Depends on Ctrl Matrix Param	*14 40(+0)
1	1	00...72	Ctrl Matrix Source8	off(0)...Assign Knob8(72)	*14 0(off)
1	1	00...2E	Ctrl Matrix Param 8	off...PEG Attack(2E)	*14 0(off)
1	1	00...7F	Ctrl Matrix Depth 8	Depends on Ctrl Matrix Param	*14 40(+0)
1	1	00...72	Ctrl Matrix Source9	off(0)...Assign Knob8(72)	*14 0(off)
1	1	00...2E	Ctrl Matrix Param 9	off...PEG Attack(2E)	*14 0(off)
1	1	00...7F	Ctrl Matrix Depth 9	Depends on Ctrl Matrix Param	*14 40(+0)
1	1	00...72	Ctrl Matrix Source10	off(0)...Assign Knob8(72)	*14 0(off)
1	1	00...2E	Ctrl Matrix Param 10	off...PEG Attack(2E)	*14 0(off)
1	1	00...7F	Ctrl Matrix Depth 10	Depends on Ctrl Matrix Param	*14 40(+0)
1	1	00...72	Ctrl Matrix Source11	off(0)...Assign Knob8(72)	*14 0(off)
1	1	00...2E	Ctrl Matrix Param 11	off...PEG Attack(2E)	*14 0(off)
1	1	00...7F	Ctrl Matrix Depth 11	Depends on Ctrl Matrix Param	*14 40(+0)
1	1	00...72	Ctrl Matrix Source12	off(0)...Assign Knob8(72)	*14 0(off)
1	1	00...2E	Ctrl Matrix Param 12	off...PEG Attack(2E)	*14 0(off)
1	1	00...7F	Ctrl Matrix Depth 12	Depends on Ctrl Matrix Param	*14 40(+0)
1	1	00...72	Ctrl Matrix Source13	off(0)...Assign Knob8(72)	*14 0(off)
1	1	00...2E	Ctrl Matrix Param 13	off...PEG Attack(2E)	*14 0(off)
1	1	00...7F	Ctrl Matrix Depth 13	Depends on Ctrl Matrix Param	*14 40(+0)
1	1	00...72	Ctrl Matrix Source14	off(0)...Assign Knob8(72)	*14 0(off)
1	1	00...2E	Ctrl Matrix Param 14	off...PEG Attack(2E)	*14 0(off)
1	1	00...7F	Ctrl Matrix Depth 14	Depends on Ctrl Matrix Param	*14 40(+0)
1	1	00...72	Ctrl Matrix Source15	off(0)...Assign Knob8(72)	*14 0(off)
1	1	00...2E	Ctrl Matrix Param 15	off...PEG Attack(2E)	*14 0(off)
1	1	00...7F	Ctrl Matrix Depth 16	Depends on Ctrl Matrix Param	*14 40(+0)
1	1		NOT USED		--
1	1		NOT USED		--
1	1		NOT USED		--
1	1		NOT USED		--
1	1	3E...42	Oct Shift	-2(3E), 0(40),+2(42)	40(+0)
1	1	00...7F	PEG Attack	0...127	0
1	1	00...14	LFO2 Wave	sine(0)...offset-s/h2(14)	05(triangle)
1	1	00...0F	LFO Assign Group	VCO1(bit3),VCO2(bit2),VCA(bit1), VCF(bit0)	00(LFO1 to All)
1	1	01...03	FM Algorithm	both(1),master(2),slave(3)	*13 03(slave)
(from Here : User Voice StepSEQ's Data)					
1	1	00...09	Step Seq Base Unit	3/8(0)...1/32(9)	04(1/8)
1	1	01...10	Step Seq Length	1step(0)...16steps(10)	8
1	1	00...03	Step Seq Loop Type	forward(0),backward(1),alternateA(2), alternateB(3)	00(forward)
1	1	00...60	Step Seq Ctrl Change No	off(0)...95,AT(60)	00(off)
1	1		NOT USED		--
1	1		NOT USED		--
1	1	00...7F	Step Seq Note No 1	C-2(0)...G8(7F)	C3(3C)
1	1	00...7F	Step Seq Note No 2	C-2(0)...G8(7F)	C3(3C)
1	1	00...7F	Step Seq Note No 3	C-2(0)...G8(7F)	C3(3C)
1	1	00...7F	Step Seq Note No 4	C-2(0)...G8(7F)	C3(3C)
1	1	00...7F	Step Seq Note No 5	C-2(0)...G8(7F)	C3(3C)
1	1	00...7F	Step Seq Note No 6	C-2(0)...G8(7F)	C3(3C)
1	1	00...7F	Step Seq Note No 7	C-2(0)...G8(7F)	C3(3C)
1	1	00...7F	Step Seq Note No 8	C-2(0)...G8(7F)	C3(3C)
1	1	00...7F	Step Seq Note No 9	C-2(0)...G8(7F)	C3(3C)
1	1	00...7F	Step Seq Note No 10	C-2(0)...G8(7F)	C3(3C)
1	1	00...7F	Step Seq Note No 11	C-2(0)...G8(7F)	C3(3C)
1	1	00...7F	Step Seq Note No 12	C-2(0)...G8(7F)	C3(3C)
1	1	00...7F	Step Seq Note No 13	C-2(0)...G8(7F)	C3(3C)
1	1	00...7F	Step Seq Note No 14	C-2(0)...G8(7F)	C3(3C)
1	1	00...7F	Step Seq Note No 15	C-2(0)...G8(7F)	C3(3C)
1	1	00...7F	Step Seq Note No 16	C-2(0)...G8(7F)	C3(3C)
1	1	00...7F	Step Seq Velocity 1	rest(0),1...127	100(64)
1	1	00...7F	Step Seq Velocity 2	rest(0),1...127	100(64)
1	1	00...7F	Step Seq Velocity 3	rest(0),1...127	100(64)
1	1	00...7F	Step Seq Velocity 4	rest(0),1...127	100(64)
1	1	00...7F	Step Seq Velocity 5	rest(0),1...127	100(64)
1	1	00...7F	Step Seq Velocity 6	rest(0),1...127	100(64)
1	1	00...7F	Step Seq Velocity 7	rest(0),1...127	100(64)
1	1	00...7F	Step Seq Velocity 8	rest(0),1...127	100(64)
1	1	00...7F	Step Seq Velocity 9	rest(0),1...127	100(64)
1	1	00...7F	Step Seq Velocity 10	rest(0),1...127	100(64)
1	1	00...7F	Step Seq Velocity 11	rest(0),1...127	100(64)
1	1	00...7F	Step Seq Velocity 12	rest(0),1...127	100(64)
1	1	00...7F	Step Seq Velocity 13	rest(0),1...127	100(64)
1	1	00...7F	Step Seq Velocity 14	rest(0),1...127	100(64)

Address (H)	Size (H)	Data (H)	Parameter	Description	Default (H)
1	00..7F		Step Seq Velocity 15	rest(0),1...127	100(64)
1	00..7F		Step Seq Velocity 16	rest(0),1...127	100(64)
1	00..7F		Step Seq Gate Time 1	1%(0)...100%(40)...200%(7F)	94%(3C)
1	00..7F		Step Seq Gate Time 2	1%(0)...100%(40)...200%(7F)	94%(3C)
1	00..7F		Step Seq Gate Time 3	1%(0)...100%(40)...200%(7F)	94%(3C)
1	00..7F		Step Seq Gate Time 4	1%(0)...100%(40)...200%(7F)	94%(3C)
1	00..7F		Step Seq Gate Time 5	1%(0)...100%(40)...200%(7F)	94%(3C)
1	00..7F		Step Seq Gate Time 6	1%(0)...100%(40)...200%(7F)	94%(3C)
1	00..7F		Step Seq Gate Time 7	1%(0)...100%(40)...200%(7F)	94%(3C)
1	00..7F		Step Seq Gate Time 8	1%(0)...100%(40)...200%(7F)	94%(3C)
1	00..7F		Step Seq Gate Time 9	1%(0)...100%(40)...200%(7F)	94%(3C)
1	00..7F		Step Seq Gate Time 10	1%(0)...100%(40)...200%(7F)	94%(3C)
1	00..7F		Step Seq Gate Time 11	1%(0)...100%(40)...200%(7F)	94%(3C)
1	00..7F		Step Seq Gate Time 12	1%(0)...100%(40)...200%(7F)	94%(3C)
1	00..7F		Step Seq Gate Time 13	1%(0)...100%(40)...200%(7F)	94%(3C)
1	00..7F		Step Seq Gate Time 14	1%(0)...100%(40)...200%(7F)	94%(3C)
1	00..7F		Step Seq Gate Time 15	1%(0)...100%(40)...200%(7F)	94%(3C)
1	00..7F		Step Seq Gate Time 16	1%(0)...100%(40)...200%(7F)	94%(3C)
1	00..7F		Step Seq CtrlChange Value 1	0...127	0(00)
1	00..7F		Step Seq CtrlChange Value 2	0...127	0(00)
1	00..7F		Step Seq CtrlChange Value 3	0...127	0(00)
1	00..7F		Step Seq CtrlChange Value 4	0...127	0(00)
1	00..7F		Step Seq CtrlChange Value 5	0...127	0(00)
1	00..7F		Step Seq CtrlChange Value 6	0...127	0(00)
1	00..7F		Step Seq CtrlChange Value 7	0...127	0(00)
1	00..7F		Step Seq CtrlChange Value 8	0...127	0(00)
1	00..7F		Step Seq CtrlChange Value 9	0...127	0(00)
1	00..7F		Step Seq CtrlChange Value10	0...127	0(00)
1	00..7F		Step Seq CtrlChange Value11	0...127	0(00)
1	00..7F		Step Seq CtrlChange Value12	0...127	0(00)
1	00..7F		Step Seq CtrlChange Value13	0...127	0(00)
1	00..7F		Step Seq CtrlChange Value14	0...127	0(00)
1	00..7F		Step Seq CtrlChange Value15	0...127	0(00)
1	00..7F		Step Seq CtrlChange Value16	0...127	0(00)
TOTAL SIZE	728				

mm = 00 —7F : User Voice No.1— User Voice No.128

- *1 : see other table(Arpeggio Type List)
- *2 : see other table(Ctrl Matrix Parameter List)
- *3 : become available only when Step Seq is selected and Kbd Mode='ptn-sel&norm' or 'ptn-sel¬e-shift'
- *4 : only when Arpeggio is selected
- *5 : only when Step Seq is selected
- *6 : except *3
- *7 : see other table (Free EG Track Paramter List)
- *8 : only Bulk Dump (not received as parameter change)
- *9 : Key Assign Mode = poly
- *10 : Key Assign Mode = mono,legato
- *11 : Oscillator Sync Mode = off
- *12 : Oscillator Sync Mode = on ('VCO1 master to slave' or 'VCO2 to VC1')
- *13 : Oscillator Sync Mode = 'VCO1 master to slave'
- *14 : see other table (Ctrl Matrix Parameter List)
- *15 : VCO1 Wave is not MultiSaw.
- *16 : VCO1 Wave is MultiSaw.
- *17 : VCO2 Wave is not Triangle or Sine.
- *18 : VCO1 Wave is Triangle or Sine.

<2-9>

MIDI Bulk Dump Parameter table (User Step Seq Pattern)

Address (H)	Size (H)	Data (H)	Parameter	Description	Default (H)
01 mm 00	1	00..09	Step Seq Base Unit	3/8(0)...1/32(9)	04(1/8)
	1	01...10	Step Seq Length	1step(0)...16steps(10)	8
	1	00..03	Step Seq Loop Type	forward(0),backward(1),alternateA(2), alternateB(3)	00(forward)
	1	00..60	Step Seq Ctrl Change No	off(0)...95,AT(60)	00(off)
	1		NOT USED		--
	1		NOT USED		--
	1	00..7F	Step Seq Note No 1	C-2(0)...G8(7F)	C3(3C)
	1	00..7F	Step Seq Note No 2	C-2(0)...G8(7F)	C3(3C)
	1	00..7F	Step Seq Note No 3	C-2(0)...G8(7F)	C3(3C)
	1	00..7F	Step Seq Note No 4	C-2(0)...G8(7F)	C3(3C)
	1	00..7F	Step Seq Note No 5	C-2(0)...G8(7F)	C3(3C)
	1	00..7F	Step Seq Note No 6	C-2(0)...G8(7F)	C3(3C)
	1	00..7F	Step Seq Note No 7	C-2(0)...G8(7F)	C3(3C)
	1	00..7F	Step Seq Note No 8	C-2(0)...G8(7F)	C3(3C)
	1	00..7F	Step Seq Note No 9	C-2(0)...G8(7F)	C3(3C)
	1	00..7F	Step Seq Note No 10	C-2(0)...G8(7F)	C3(3C)
	1	00..7F	Step Seq Note No 11	C-2(0)...G8(7F)	C3(3C)
	1	00..7F	Step Seq Note No 12	C-2(0)...G8(7F)	C3(3C)
	1	00..7F	Step Seq Note No 13	C-2(0)...G8(7F)	C3(3C)
	1	00..7F	Step Seq Note No 14	C-2(0)...G8(7F)	C3(3C)
	1	00..7F	Step Seq Note No 15	C-2(0)...G8(7F)	C3(3C)
	1	00..7F	Step Seq Note No 16	C-2(0)...G8(7F)	C3(3C)
	1	00..7F	Step Seq Velocity 1	rest(0),1...127	100(64)

MIDI Data Format

Address (H)	Size (H)	Data (H)	Parameter	Description	Default (H)
1	00..7F		Step Seq Velocity 2	rest(0),1...127	100(64)
1	00..7F		Step Seq Velocity 3	rest(0),1...127	100(64)
1	00..7F		Step Seq Velocity 4	rest(0),1...127	100(64)
1	00..7F		Step Seq Velocity 5	rest(0),1...127	100(64)
1	00..7F		Step Seq Velocity 6	rest(0),1...127	100(64)
1	00..7F		Step Seq Velocity 7	rest(0),1...127	100(64)
1	00..7F		Step Seq Velocity 8	rest(0),1...127	100(64)
1	00..7F		Step Seq Velocity 9	rest(0),1...127	100(64)
1	00..7F		Step Seq Velocity 10	rest(0),1...127	100(64)
1	00..7F		Step Seq Velocity 11	rest(0),1...127	100(64)
1	00..7F		Step Seq Velocity 12	rest(0),1...127	100(64)
1	00..7F		Step Seq Velocity 13	rest(0),1...127	100(64)
1	00..7F		Step Seq Velocity 14	rest(0),1...127	100(64)
1	00..7F		Step Seq Velocity 15	rest(0),1...127	100(64)
1	00..7F		Step Seq Velocity 16	rest(0),1...127	100(64)
1	00..7F		Step Seq Gate Time 1	1%(0)...100%(40)...200%(7F)	94%(3C)
1	00..7F		Step Seq Gate Time 2	1%(0)...100%(40)...200%(7F)	94%(3C)
1	00..7F		Step Seq Gate Time 3	1%(0)...100%(40)...200%(7F)	94%(3C)
1	00..7F		Step Seq Gate Time 4	1%(0)...100%(40)...200%(7F)	94%(3C)
1	00..7F		Step Seq Gate Time 5	1%(0)...100%(40)...200%(7F)	94%(3C)
1	00..7F		Step Seq Gate Time 6	1%(0)...100%(40)...200%(7F)	94%(3C)
1	00..7F		Step Seq Gate Time 7	1%(0)...100%(40)...200%(7F)	94%(3C)
1	00..7F		Step Seq Gate Time 8	1%(0)...100%(40)...200%(7F)	94%(3C)
1	00..7F		Step Seq Gate Time 9	1%(0)...100%(40)...200%(7F)	94%(3C)
1	00..7F		Step Seq Gate Time 10	1%(0)...100%(40)...200%(7F)	94%(3C)
1	00..7F		Step Seq Gate Time 11	1%(0)...100%(40)...200%(7F)	94%(3C)
1	00..7F		Step Seq Gate Time 12	1%(0)...100%(40)...200%(7F)	94%(3C)
1	00..7F		Step Seq Gate Time 13	1%(0)...100%(40)...200%(7F)	94%(3C)
1	00..7F		Step Seq Gate Time 14	1%(0)...100%(40)...200%(7F)	94%(3C)
1	00..7F		Step Seq Gate Time 15	1%(0)...100%(40)...200%(7F)	94%(3C)
1	00..7F		Step Seq Gate Time 16	1%(0)...100%(40)...200%(7F)	94%(3C)
1	00..7F		Step Seq CtrlChange Value 1	0...127	0(00)
1	00..7F		Step Seq CtrlChange Value 2	0...127	0(00)
1	00..7F		Step Seq CtrlChange Value 3	0...127	0(00)
1	00..7F		Step Seq CtrlChange Value 4	0...127	0(00)
1	00..7F		Step Seq CtrlChange Value 5	0...127	0(00)
1	00..7F		Step Seq CtrlChange Value 6	0...127	0(00)
1	00..7F		Step Seq CtrlChange Value 7	0...127	0(00)
1	00..7F		Step Seq CtrlChange Value 8	0...127	0(00)
1	00..7F		Step Seq CtrlChange Value 9	0...127	0(00)
1	00..7F		Step Seq CtrlChange Value10	0...127	0(00)
1	00..7F		Step Seq CtrlChange Value11	0...127	0(00)
1	00..7F		Step Seq CtrlChange Value12	0...127	0(00)
1	00..7F		Step Seq CtrlChange Value13	0...127	0(00)
1	00..7F		Step Seq CtrlChange Value14	0...127	0(00)
1	00..7F		Step Seq CtrlChange Value15	0...127	0(00)
1	00..7F		Step Seq CtrlChange Value16	0...127	0(00)
TOTAL SIZE		46			

<3-1>

AN1x Parameter Base Address

MODEL ID = 5C (AN1x)

Parameter	Address			Description
	(H)	(M)	(L)	
System	00	00	00	AN1x System
User Step Seq	01	00	00	AN1x User Step Seq Pattern 1
	:	:	:	:
	01	7F	00	AN1x User Step Seq Pattern 128
Current Voice	10	00	00	AN1x Current Voice Common
	10	0E	00	AN1x Current Voice Step Seq Pattern
	10	10	00	AN1x Current Voice Scene1
User Voice	11	00	00	AN1x User Voice 1
	:	:	:	:
	11	7F	00	AN1x User Voice 128

MIDI Implementation Chart

YAMAHA [Analog Physical Modeling Plug-in Board] Date:16-JUNE-1999
 Model PLG150-AN MIDI Implementation Chart Version : 1.0

Function...	Transmitted	Recognized	Remarks
Basic Channel	x x	1 - 16 1 - 16	
Mode	x x *****	3 3,4 (m=1) x *2	
Note Number : True voice	x *****	0 - 127 0 - 127	
Velocity Note ON Note OFF	x x	o 9nH, v=1-127 x	
After Touch	x x	x o *1	
Pitch Bend	x	o 0-24 semi *1	
Control	x x x x	o *1 o *1 o *1 x	Bank Select Data Entry
Change	0,32 1,5,7,10,11 6,38 64,65 71-75 0-95 96-97 98-99 100-101	x *1 x *1 x *1 x *1 x *1 x *1 x *1 x *1	Sound Controller Assignable Cntrl RPN Inc,Dec NRPN LSB,MSB RPN LSB,MSB

Prog Change : True #	X *****	o 0 - 127	
System Exclusive	o *3	o *3	
: Song Pos. Common : Song Sel. : Tune	X X X	X X X	
System : Clock Real Time: Commands	X X	o o	*4 *4
Aux : All Sound OFF : Reset All Chtrls : Local ON/OFF : All Notes OFF Mes- : Active Sense sages: Reset	X X X X X X	o(120,126,127) o(121) X o(123-125) o X	
Notes:	*1 receive if switch is on. *2 m is always treated as "1" regardless of its value. *3 transmit/receive if exclusive switch is on. *4 if MIDI sync is midi.		

Mode 1 : OMNI ON , POLY Mode 2 : OMNI ON , MONO o : Yes
 Mode 3 : OMNI OFF, POLY Mode 4 : OMNI OFF, MONO x : No

SOFTWARE LICENSING AGREEMENT

The following is a legal agreement between you, the end user, and Yamaha Corporation (“Yamaha”). The enclosed Yamaha software program is licensed by Yamaha to the original purchaser for use only on the terms set forth herein. Please read this licensing agreement with care. Opening this package indicates that you accept all terms outlined herein. If you do not agree to the terms, return this package unopened to Yamaha for a full refund.

1. GRANT OF LICENSE AND COPYRIGHT

Yamaha grants you, the original purchaser, the right to use one copy of the enclosed software program and data (“SOFTWARE”) on a single-user computer system. You may not use it on more than one computer or computer terminal. The SOFTWARE is owned by Yamaha and is protected by Japanese copyright laws and all applicable international treaty provisions. You are entitled to claim ownership of the media in which the SOFTWARE is included. Therefore, you must treat the SOFTWARE like any other copyrighted materials.

2. RESTRICTIONS

The SOFTWARE program is copyrighted. You may not engage in reverse engineering or reproduction of the SOFTWARE by other conceivable methods. You may not reproduce, modify, change, rent, lease, resell, or distribute the SOFTWARE in whole or in part, or create derivative works from the SOFTWARE. You may not transmit or network the SOFTWARE with other computers.

You may transfer ownership of the SOFTWARE and the accompanying written materials on a permanent basis provided that you retain no copies and the recipient agrees to the terms of the licensing agreement.

3. TERMINATION

The licensing condition of the software program becomes effective on the day that you receive the SOFTWARE. If any one of the copyright laws or clauses of the licensing conditions is violated, the licensing agreement shall be terminated automatically without notice from Yamaha. In this case, you must destroy the licensed SOFTWARE and its copies immediately.

4. PRODUCT WARRANTY

Yamaha warrants to the original purchaser that if the SOFTWARE, when used in normal conditions, will not perform the functions described in the manual provided by Yamaha, the sole remedy will be that Yamaha will replace any media which proves defective in materials or workmanship on an exchange basis without charge. Except as expressly set forth above, the SOFTWARE is provided “as is,” and no other warranties, either expressed or implied, are made with respect to this software, including, without limitation the implied warranties of merchantability and fitness for a particular purpose.

5. LIMITED LIABILITY

Your sole remedies and Yamaha’s entire liability are as set forth above. In no event will Yamaha be liable to you or any other person for any damages, including without limitation any incidental or consequential damages, expenses, lost profits, lost savings or other damages arising out of the use or inability to use such SOFTWARE even if Yamaha or an authorized dealer has been advised of the possibility of such damages, or for any claim by any other party.

6. GENERAL

This license agreement shall be interpreted according to and governed by Japanese laws.

SOFTWARE-LIZENZVEREINBARUNG

Die folgende Vereinbarung ist eine rechtsgültige Vereinbarung zwischen Ihnen, dem Endanwender, und der Yamaha Corporation („Yamaha“). Yamaha erteilt dem ursprünglichen Käufer für das beiliegende Yamaha-Softwareprogramm ausschließlich zu den hier ausgeführten Bedingungen eine Lizenz zur Verwendung. Bitte lesen Sie diese Lizenzvereinbarung sorgfältig. Durch das Öffnen dieser Packung bringen Sie zum Ausdruck, daß Sie alle darin enthaltenen Bedingungen akzeptieren. Wenn Sie nicht mit den Bedingungen einverstanden sind, können Sie die Packung ungeöffnet an Yamaha zurückgeben; der Kaufpreis wird in voller Höhe zurückerstattet.

1. ERETLUNG VON LIZENZ UND COPYRIGHT

Yamaha erteilt Ihnen, dem ursprünglichen Käufer, das Recht, ein Exemplar des beiliegenden Softwareprogramms und der darin enthaltenen Daten („SOFTWARE“) als Einzelperson auf jeweils einem Computer zu verwenden. Sie dürfen sie nicht auf mehr als einem Computer bzw. einer Computerstation verwenden. Die SOFTWARE bleibt im Besitz von Yamaha und ist durch japanische Copyrightgesetze sowie alle anwendbaren internationalen Vertragsbestimmungen geschützt. Sie haben ein Anspruchsrecht auf das Eigentum an den Medien, denen die SOFTWARE beiliegt. Daher müssen Sie die SOFTWARE wie alle anderen durch Copyright geschützten Materialien behandeln.

2. EINSCHRÄNKUNGEN

Die SOFTWARE ist durch Copyright geschützt. Sie dürfen Sie weder analysieren noch durch anderweitige Methoden reproduzieren. Sie dürfen die SOFTWARE weder ganz noch teilweise reproduzieren, modifizieren, verändern, gegen Entgelt oder unentgeltlich verleihen, verkaufen oder vertreiben, und Sie dürfen auf der Grundlage der SOFTWARE keine Ableitungen erstellen. Sie dürfen die SOFTWARE nicht an andere Computer senden oder in Netzwerke einspeisen. Sie dürfen das Eigentum an der SOFTWARE und den schriftlichen Begleitmaterialien auf unbefristeter Basis unter den Voraussetzungen übertragen, daß Sie keine Kopien zurückbehalten und sich der Empfänger mit den Bedingungen der Lizenzvereinbarung einverstanden erklärt.

3. BEENDIGUNG

Die Lizenzbedingung des Softwareprogramms wird am Tag, an dem Sie die SOFTWARE erhalten, wirksam. Falls ein Copyrightgesetz oder eine Bestimmung der Lizenzbedingungen verletzt wird, wird automatisch und ohne Benachrichtigung durch Yamaha die Lizenzvereinbarung beendet. In diesem Fall müssen Sie die lizenzierte SOFTWARE und ihre Kopien unverzüglich vernichten.

4. PRODUKTGARANTIE

Yamaha garantiert dem ursprünglichen Käufer, daß, falls die SOFTWARE bei Verwendung unter normalen Bedingungen nicht die in der von Yamaha bereitgestellten Anleitung beschriebenen Funktionen erfüllt, die einzige Abhilfe darin bestehen wird, daß Yamaha auf Austauschbasis kostenlos jedes Medium ersetzen wird, das Material- oder Verarbeitungsfehler aufweist. Abgesehen von dem oben Ausgeführten wird die SOFTWARE „wie die Ware liegt und steht“ geliefert, und es werden keine anderen ausdrücklichen oder stillschweigenden Garantien hinsichtlich dieser Software übernommen, einschließlich, aber nicht beschränkt auf, die stillschweigenden Garantien für handelsübliche Qualität und Eignung für einen bestimmten Einsatzzweck.

5. BESCHRÄNKTE HAFTUNG

Ihre einzige Abhilfe und die gesamte Haftung Yamahas bestehen in dem oben Ausgeführten. Keinesfalls haftet Yamaha Ihnen oder einer anderen Person gegenüber für etwaige Schäden, einschließlich, aber nicht beschränkt auf, zufällige Schäden oder Folgeschäden, Kosten, Verdienstausfall, verlorene Ersparnisse oder andere Schadenersatzansprüche, die aus der Verwendung der SOFTWARE oder aus der Tatsache hervorgehen, daß diese SOFTWARE nicht verwendet werden konnte, selbst wenn Yamaha oder ein autorisierter Händler über die Möglichkeit derartiger Schadenersatzansprüche informiert wurde, oder für etwaige andere Ansprüche einer anderen Partei.

6. ALLGEMEINES

Diese Lizenzvereinbarung soll gemäß und in Übereinstimmung mit den japanischen Gesetzen ausgelegt werden.

CONTRAT DE LICENCE DE LOGICIEL

Ceci est un contrat entre vous-même, l'utilisateur final, et Yamaha Corporation ("Yamaha"). Le logiciel Yamaha ci-inclus est concédé sous licence par Yamaha à l'acheteur original et ne peut être utilisé que dans les conditions prévues aux présentes. Veuillez lire attentivement ce contrat de licence. Le fait d'ouvrir ce coffret indique que vous acceptez l'ensemble des termes du contrat. Si vous n'acceptez pas lesdits termes, renvoyez le coffret non ouvert à Yamaha pour en obtenir le remboursement intégral.

1. CONCESSION DE LICENCE ET DROITS D'AUTEUR

Yamaha vous concède le droit d'utiliser, en tant qu'acheteur original, un exemplaire du logiciel et des données afférentes à celui-ci ("LOGICIEL") sur un ordinateur pour utilisateur unique. Vous n'êtes pas autorisé à utiliser ces éléments sur plus d'un ordinateur ou terminal d'ordinateur. Le LOGICIEL est la propriété de Yamaha. Il est protégé par les dispositions relatives au droit d'auteur contenues dans la législation japonaise et les traités internationaux. Vous êtes en droit de revendiquer l'appartenance du support du LOGICIEL. A ce titre, vous devez traiter le LOGICIEL comme tout autre élément protégé par le droit d'auteur.

2. RESTRICTIONS

Le LOGICIEL est protégé par le droit d'auteur. Vous n'êtes pas autorisé à reconstituer la logique du LOGICIEL ou à reproduire ce dernier par quelque autre moyen que ce soit. Vous n'êtes pas en droit de reproduire, modifier, prêter, louer, revendre ou distribuer le LOGICIEL en tout ou partie, ou d'utiliser le LOGICIEL à des fins de création dérivée. Vous n'êtes pas autorisé à transmettre le LOGICIEL à d'autres ordinateurs ou à l'utiliser en réseau.

Vous êtes en droit de céder, à titre permanent, le LOGICIEL et la documentation imprimée qui l'accompagne, sous réserve que vous n'en conserviez aucun exemplaire et que le bénéficiaire accepte les termes du présent contrat.

3. RESILIATION

Les conditions énoncées dans le présent contrat de licence prennent effet à compter du jour où le LOGICIEL vous est remis. Si l'une quelconque des dispositions relatives au droit d'auteur ou des clauses du contrat ne sont pas respectées, le contrat de licence sera résilié de plein droit par Yamaha, ce sans préavis. Dans ce cas, vous devrez immédiatement détruire le LOGICIEL concédé sous licence ainsi que les copies réalisées.

4. GARANTIE PRODUIT

Si, dans des conditions normales d'utilisation, le LOGICIEL ne remplit pas les fonctions décrites dans le manuel fourni, Yamaha s'engage vis-à-vis de l'acheteur original à remplacer gratuitement, sur la base d'un échange, tout support reconnu défectueux par suite d'un défaut de matière première ou d'un vice de fabrication. Ceci constitue le seul recours opposable à Yamaha. Hormis dans les cas expressément énoncés plus haut, le LOGICIEL est livré "en l'état" et toute autre garantie expresse ou implicite le concernant, y compris, de manière non limitative, toute garantie implicite de qualité marchande et d'adéquation à un usage particulier, est exclue.

5. RESPONSABILITE LIMITEE

Votre unique recours et la seule responsabilité de Yamaha sont tels qu'énoncés précédemment. En aucun cas Yamaha ne pourra être tenu responsable, par vous-même ou une autre personne, de quelques dommages que ce soit, notamment et de manière non limitative, de dommages indirects, frais, pertes de bénéfices, pertes de fonds ou d'autres dommages résultant de l'utilisation ou de l'impossibilité d'utiliser le LOGICIEL, même si Yamaha ou un distributeur agréé ont été prévenus de l'éventualité de tels dommages, ou de quelque autre revendication formulée par une tierce partie.

6. REMARQUE GENERALE

Le présent contrat de licence est régi par le droit japonais, à la lumière duquel il doit être interprété.

For details of products, please contact your nearest Yamaha or the authorized distributor listed below.

Pour plus de détails sur les produits, veuillez-vous adresser à Yamaha ou au distributeur le plus proche de vous figurant dans la liste suivante.

Die Einzelheiten zu Produkten sind bei Ihrer unten aufgeführten Niederlassung und bei Yamaha Vertragshändlern in den jeweiligen Bestimmungsländern erhältlich.

Para detalles sobre productos, contacte su tienda Yamaha más cercana o el distribuidor autorizado que se lista debajo.

NORTH AMERICA

CANADA

Yamaha Canada Music Ltd.
135 Milner Avenue, Scarborough, Ontario,
M1S 3R1, Canada
Tel: 416-298-1311

U.S.A.

Yamaha Corporation of America
6600 Orangethorpe Ave., Buena Park, Calif.
90620, U.S.A.
Tel: 714-522-9011

CENTRAL & SOUTH AMERICA

MEXICO

Yamaha de Mexico S.A. De C.V.,
Departamento de ventas
Javier Rojo Gomez No.1149, Col. Gpe Del
Moral, Deleg. Iztapalapa, 09300 Mexico, D.F.
Tel: 686-00-33

BRAZIL

Yamaha Musical do Brasil LTDA.
Av. Reboças 2636, São Paulo, Brasil
Tel: 011-853-1377

ARGENTINA

Yamaha Music Argentina S.A.
Viamonte 1145 Piso2-B 1053,
Buenos Aires, Argentina
Tel: 1-371-7021

PANAMA AND OTHER LATIN AMERICAN COUNTRIES/ CARIBBEAN COUNTRIES

Yamaha de Panama S.A.
Torre Banco General, Piso 7, Urbanización Marbella,
Calle 47 y Aquilino de la Guardia,
Ciudad de Panamá*, Panamá*
Tel: 507-269-5311

EUROPE

THE UNITED KINGDOM

Yamaha-Kemble Music (U.K.) Ltd.
Sherbourne Drive, Tilbrook, Milton Keynes,
MK7 8BL, England
Tel: 01908-366700

IRELAND

Danfay Ltd.
61D, Sallynoggin Road, Dun Laoghaire, Co. Dublin
Tel: 01-2859177

GERMANY/SWITZERLAND

Yamaha Europa GmbH.
Siemensstraße 22-34, 25462 Rellingen,
F.R. of Germany
Tel: 04101-3030

AUSTRIA

Yamaha Music Austria
Schleiergasse 20, A-1100 Wien Austria
Tel: 01-60203900

THE NETHERLANDS

Yamaha Music Nederland
Kanaalweg 18G, 3526KL, Utrecht, The Netherlands
Tel: 030-2828411

BELGIUM

Yamaha Music Belgium
Keiberg Imperiastraat 8, 1930 Zaventem, Belgium
Tel: 02-7258220

FRANCE

**Yamaha Musique France,
Division Professionnelle**
BP 70-77312 Marne-la-Vallée Cedex 2, France
Tel: 01-64-61-4000

ITALY

**Yamaha Musica Italia S.P.A.,
Combo Division**
Viale Italia 88, 20020 Lainate (Milano), Italy
Tel: 02-935-771

SPAIN/PORTUGAL

Yamaha-Hazen Electronica Musical, S.A.
Jorge Juan 30, 28001, Madrid, Spain
Tel: 91-577-7270

GREECE

Philippe Nakas S.A.
Navarinou Street 13, P.Code 10680, Athens,
Greece
Tel: 01-364-7111

SWEDEN

Yamaha Scandinavia AB
J. A. Wettergrens Gata 1
Box 30053
S-400 43 Göteborg, Sweden
Tel: 031 89 34 00

DENMARK

YS Copenhagen Liaison Office
Generatorvej 8B
DK-2730 Herlev, Denmark
Tel: 44 92 49 00

FINLAND

F-Musiikki Oy
Kluuvikatu 6, P.O. Box 260,
SF-00101 Helsinki, Finland
Tel: 09 618511

NORWAY

Norsk filial av Yamaha Scandinavia AB
Grini Næringspark 1
N-1345 Østerås, Norway
Tel: 67 16 77 70

ICELAND

Skifan HF
Skeifan 17 P.O. Box 8120
IS-128 Reykjavik, Iceland
Tel: 525 5000

OTHER EUROPEAN COUNTRIES

Yamaha Europa GmbH.
Siemensstraße 22-34, 25462 Rellingen, F.R. of
Germany
Tel: 04101-3030

AFRICA

**Yamaha Corporation,
International Marketing Division**
Nakazawa-cho 10-1, Hamamatsu, Japan 430-
8650
Tel: 053-460-2312

MIDDLE EAST

TURKEY/CYPRUS

Yamaha Europa GmbH.
Siemensstraße 22-34, 25462 Rellingen,
F.R. of Germany
Tel: 04101-3030

OTHER COUNTRIES

Yamaha Music Gulf FZE
LB21-128 Jebel Ali Freezone
P.O.Box 17328, Dubai, U.A.E.
Tel: 971-4-81-5868

ASIA

HONG KONG

Tom Lee Music Co., Ltd.
11/F., Silvercord Tower 1, 30 Canton Road,
Tsimshatsui, Kowloon, Hong Kong
Tel: 2737-7688

INDONESIA

**PT. Yamaha Music Indonesia (Distributor)
PT. Nusantik**
Gedung Yamaha Music Center, Jalan Jend. Gatot
Subroto Kav. 4, Jakarta 12930, Indonesia
Tel: 21-520-2577

KOREA

Cosmos Corporation
1461-9, Seocho Dong, Seocho Gu, Seoul, Korea
Tel: 02-3486-0011

MALAYSIA

Yamaha Music Malaysia, Sdn., Bhd.
Lot 8, Jalan Perbandaran, 47301 Kelana Jaya,
Petaling Jaya, Selangor, Malaysia
Tel: 3-703-0900

PHILIPPINES

Yupango Music Corporation
339 Gil J. Puyat Avenue, P.O. Box 885 MCPO,
Makati, Metro Manila, Philippines
Tel: 819-7551

SINGAPORE

Yamaha Music Asia Pte., Ltd.
11 Ubi Road #06-00, Meiban Industrial Building,
Singapore
Tel: 65-747-4374

TAIWAN

Yamaha KHS Music Co., Ltd.
10F, 150, Tun-Hwa Northroad,
Taipei, Taiwan, R.O.C.
Tel: 02-2713-8999

THAILAND

Siam Music Yamaha Co., Ltd.
121/60-61 RS Tower 17th Floor,
Ratchadaphisek RD., Dindaeng,
Bangkok 10320, Thailand
Tel: 02-641-2951

THE PEOPLE'S REPUBLIC OF CHINA AND OTHER ASIAN COUNTRIES

**Yamaha Corporation,
International Marketing Division**
Nakazawa-cho 10-1, Hamamatsu, Japan 430-8650
Tel: 053-460-2317

OCEANIA

AUSTRALIA

Yamaha Music Australia Pty. Ltd.
17-33 Market Street, South Melbourne, Vic.
3205, Australia
Tel: 3-699-2388

NEW ZEALAND

Music Houses of N.Z. Ltd.
146/148 Captain Springs Road, Te Papapa,
Auckland, New Zealand
Tel: 9-634-0099

COUNTRIES AND TRUST

TERRITORIES IN PACIFIC OCEAN

**Yamaha Corporation,
International Marketing Group**
Nakazawa-cho 10-1, Hamamatsu, Japan 430-8650
Tel: 053-460-2312

Cover 4

