



UAB

Digital Sound Projector

# YSP-1600



## Quick Reference Guide



For more detailed information, refer to the Owner's Manual on the CD-ROM.

**Caution: Do not attempt to play this CD-ROM in an audio player.**

# IMPORTANT SAFETY INSTRUCTIONS

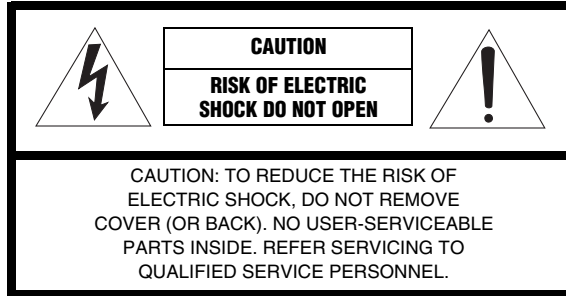

## • Explanation of Graphical Symbols

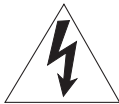

The lightning flash with arrowhead symbol, within an equilateral triangle, is intended to alert you to the presence of uninsulated “dangerous voltage” within the product’s enclosure that may be of sufficient magnitude to constitute a risk of electric shock to persons.



The exclamation point within an equilateral triangle is intended to alert you to the presence of important operating and maintenance (servicing) instructions in the literature accompanying the appliance.

- 1 Read these instructions.
- 2 Keep these instructions.
- 3 Heed all warnings.
- 4 Follow all instructions.
- 5 Do not use this apparatus near water.
- 6 Clean only with dry cloth.
- 7 Do not block any ventilation openings. Install in accordance with the manufacturer’s instructions.
- 8 Do not install near any heat sources such as radiators, heat registers, stoves, or other apparatus (including amplifiers) that produce heat.
- 9 Do not defeat the safety purpose of the polarized or grounding-type plug. A polarized plug has two blades with one wider than the other. A grounding type plug has two blades and a third grounding prong. The wide blade or the third prong are provided for your safety. If the provided plug does not fit into your outlet, consult an electrician for replacement of the obsolete outlet.
- 10 Protect the power cord from being walked on or pinched particularly at plugs, convenience receptacles, and the point where they exit from the apparatus.

- 11 Only use attachments/accessories specified by the manufacturer.
- 12 Use only with the cart, stand, tripod, bracket, or table specified by the manufacturer, or sold with the apparatus. When a cart is used, use caution when moving the cart/apparatus combination to avoid injury from tip-over.
- 13 Unplug this apparatus during lightning storms or when unused for long periods of time.
- 14 Refer all servicing to qualified service personnel. Servicing is required when the apparatus has been damaged in any way, such as power-supply cord or plug is damaged, liquid has been spilled or objects have fallen into the apparatus, the apparatus has been exposed to rain or moisture, does not operate normally, or has been dropped.



## IMPORTANT

Please record the serial number of this unit in the space below.

MODEL:

Serial No.:

The serial number is located on the rear of the unit. Retain this Owner's Manual in a safe place for future reference.

## We Want You Listening For A Lifetime



Yamaha and the Electronic Industries Association’s Consumer Electronics Group want you to get the most out of your equipment by playing it at a safe level. One that lets the sound come through loud and clear without annoying blaring or distortion – and, most importantly, without affecting your sensitive hearing. Since hearing damage from loud sounds is often undetectable until it is too late, Yamaha and the Electronic Industries Association’s Consumer Electronics Group recommend you to avoid prolonged exposure from excessive volume levels.

## FCC INFORMATION (for US customers)

### 1 **IMPORTANT NOTICE: DO NOT MODIFY THIS UNIT!**

This product, when installed as indicated in the instructions contained in this manual, meets FCC requirements. Modifications not expressly approved by Yamaha may void your authority, granted by the FCC, to use the product.

### 2 **IMPORTANT:** When connecting this product to accessories and/or another product use only high quality shielded cables. Cable/s supplied with this product **MUST** be used. Follow all installation instructions. Failure to follow instructions could void your FCC authorization to use this product in the USA.

### 3 **NOTE:** This product has been tested and found to comply with the requirements listed in FCC Regulations, Part 15 for Class "B" digital devices. Compliance with these requirements provides a reasonable level of assurance that your use of this product in a residential environment will not result in harmful interference with other electronic devices.

This equipment generates/uses radio frequencies and, if not installed and used according to the instructions found in the users manual, may cause interference harmful to the operation of other electronic devices.

Compliance with FCC regulations does not guarantee that interference will not occur in all installations. If this product is found to be the source of interference, which can be determined by turning the unit "OFF" and "ON", please try to eliminate the problem by using one of the following measures:

Relocate either this product or the device that is being affected by the interference.

Utilize power outlets that are on different branch (circuit breaker or fuse) circuits or install AC line filter/s.

In the case of radio or TV interference, relocate/reorient the antenna. If the antenna lead-in is 300 ohm ribbon lead, change the lead-in to coaxial type cable.

If these corrective measures do not produce satisfactory results, please contact the local retailer authorized to distribute this type of product. If you can not locate the appropriate retailer, please contact Yamaha Corporation of America A/V Division, 6600 Orangethorpe Avenue, Buena Park, CA 90620, USA.

The above statements apply **ONLY** to those products distributed by Yamaha Corporation of America or its subsidiaries.

## NOTICE

This equipment has been tested and found to comply with the limits for a Class B digital device, pursuant to part 15 of the FCC Rules. These limits are designed to provide reasonable protection against harmful interference in a residential installation. This equipment generates, uses and can radiate radio frequency energy and, if not installed and used in accordance with the instructions, may cause harmful interference to radio communications. However, there is no guarantee that interference will not occur in a particular installation. If this equipment does cause harmful interference to radio or television reception, which can be determined by turning the equipment off and on, the user is encouraged to try to correct the interference by one or more of the following measures:

- Reorient or relocate the receiving antenna.
- Increase the separation between the equipment and receiver.
- Connect the equipment into an outlet on a circuit different from that to which the receiver is connected.
- Consult the dealer or an experienced radio/TV technician for help.

This equipment complies with FCC/IC radiation exposure limits set forth for an uncontrolled environment and meets the FCC radio frequency (RF) Exposure Guidelines and RSS-102 of the IC radio frequency (RF) Exposure rules. This equipment should be installed and operated keeping the radiator at least 20cm or more away from person's body.

This transmitter must not be co-located or operated in conjunction with any other antenna or transmitter.

## COMPLIANCE INFORMATION STATEMENT (DECLARATION OF CONFORMITY PROCEDURE)

Responsible Party: Yamaha Corporation of America A/V Division  
Address: 6600 Orangethorpe Avenue, Buena Park, CA 90620  
Telephone: 714-522-9011  
Type of Equipment: Digital Sound Projector  
Model Name: YSP-1600

This device complies with Part 15 of FCC Rules and Industry Canada licence-exempt RSS standard(s).

Operation is subject to the following two conditions:

- (1) this device may not cause interference, and
- (2) this device must accept any interference, including interference that may cause undesired operation of this device.

## FOR CANADIAN CUSTOMERS

To prevent electric shock, match wide blade of plug to wide slot and fully insert.  
CAN ICES-3 (B)/NMB-3 (B)

## CAUTION: READ THIS BEFORE OPERATING YOUR UNIT.

- To assure the finest performance, please read this manual carefully. Keep it in a safe place for future reference.
- Install this sound system in a well ventilated, cool, dry, clean place - away from direct sunlight, heat sources, vibration, dust, moisture, and/or cold. For proper ventilation, allow the following minimum clearances.  
Top: 10 cm (4 in), Rear: 10 cm (4 in), Sides: 10 cm (4 in)
- Locate this unit away from other electrical appliances, motors, or transformers to avoid humming sounds.
- Do not expose this unit to sudden temperature changes from cold to hot, and do not locate this unit in an environment with high humidity (i.e. a room with a humidifier) to prevent condensation inside this unit, which may cause an electrical shock, fire, damage to this unit, and/or personal injury.
- Avoid installing this unit where foreign object may fall onto this unit and/or this unit may be exposed to liquid dripping or splashing. On the top of this unit, do not place:
  - Other components, as they may cause damage and/or discoloration on the surface of this unit.
  - Burning objects (i.e. candles), as they may cause fire, damage to this unit, and/or personal injury.
  - Containers with liquid in them, as they may fall and liquid may cause electrical shock to the user and/or damage to this unit.
- Do not cover this unit with a newspaper, tablecloth, curtain, etc. in order not to obstruct heat radiation. If the temperature inside this unit rises, it may cause fire, damage to this unit, and/or personal injury.
- Do not plug in this unit to a wall outlet until all connections are complete.
- Do not operate this unit upside-down. It may overheat, possibly causing damage.
- Do not use force on switches, knobs and/or cords.
- When disconnecting the power cable from the wall outlet, grasp the plug; do not pull the cable.
- Do not clean this unit with chemical solvents; this might damage the finish. Use a clean, dry cloth.
- Only voltage specified on this unit must be used. Using this unit with a higher voltage than specified is dangerous and may cause fire, damage to this unit, and/or personal injury. Yamaha will not be held responsible for any damage resulting from use of this unit with a voltage other than specified.
- To prevent damage by lightning, keep the power cable and outdoor antennas disconnected from a wall outlet or this unit during a lightning storm.
- Do not attempt to modify or fix this unit. Contact qualified Yamaha service personnel when any service is needed. The cabinet should never be opened for any reasons.
- When not planning to use this unit for long periods of time (i.e. vacation), disconnect the AC power plug from the wall outlet.
- Be sure to refer to the "Troubleshooting" section of the Owner's Manual on the CD-ROM for common operating errors before concluding that this unit is faulty.
- Before moving this unit, press  $\phi$  to set it to standby mode and disconnect the AC power plug from the wall outlet.
- Condensation will form when the surrounding temperature changes suddenly. Disconnect the power cable from the outlet, then leave this unit alone.
- When using this unit for a long time, this unit may become warm. Turn the power off, then leave this unit alone for cooling.
- Install this unit near the AC outlet and where the AC power plug can be reached easily.
- The batteries shall not be exposed to excessive heat such as sunshine, fire or the like. When you dispose of batteries, follow your regional regulations.
- Excessive sound pressure from earphones and headphones can cause hearing loss.
- Keep the product out of reach of children to avoid them swallowing small parts.

This unit is not disconnected from the AC power source as long as it is connected to the wall outlet, even if this unit itself is turned off by  $\phi$ . This state is called the standby mode. In this state, this unit is designed to consume a very small quantity of power.

**WARNING**  
TO REDUCE THE RISK OF FIRE OR ELECTRIC SHOCK, DO NOT EXPOSE THIS UNIT TO RAIN OR MOISTURE.

Do not use this unit within 22 cm (9 inches) of persons with a heart pacemaker implant or defibrillator implant.

Radio waves may affect electro-medical devices.  
Do not use this unit near medical devices or inside medical facilities.

The name plate of YSP-1600 is located on the bottom of the unit.

We, Yamaha Music Europe GmbH hereby declare that this unit is in compliance with the essential requirements and other relevant provisions of Directive 1999/5/EC.



**Yamaha Music Europe GmbH**  
Siemensstr. 22-34 25462 Rellingen, Germany  
Tel: +49-4101-303-0

## ■ Notes on remote controls and batteries

- Do not spill water or other liquids on the remote control.
- Do not drop the remote control.
- Do not leave or store the remote control in the following conditions:
  - places of high humidity, such as near a bath
  - places of high temperatures, such as near a heater or stove
  - places of extremely low temperatures
  - dusty places
- Insert the battery according to the polarity markings (+ and -).
- If the batteries grow old, the effective operation range of the remote control decreases considerably. If this happens, replace the batteries with two new ones as soon as possible.
- If the batteries run out, immediately remove them from the remote control to prevent an explosion or acid leak.
- If you find leaking batteries, discard the batteries immediately, taking care not to touch the leaked material. If the leaked material comes into contact with your skin or gets into your eyes or mouth, rinse it away immediately and consult a doctor. Clean the battery compartment thoroughly before installing new batteries.
- Do not use old batteries together with new ones. This may shorten the life of the new batteries or cause old batteries to leak.
- Do not use different types of batteries (such as alkaline and manganese batteries) together. Danger of explosion may happen if batteries are incorrectly replaced. Specification of batteries may be different even though they look the same.
- Before inserting new batteries, wipe the compartment clean.
- Keep batteries away from children. If a battery is accidentally swallowed, contact your doctor immediately.
- When not planning to use the remote control for long periods of time, remove the batteries from the remote control.
- Do not charge or disassemble the supplied batteries.

## ■ For U.K. customers

If the socket outlets in the home are not suitable for the plug supplied with this appliance, it should be cut off and an appropriate 3 pin plug fitted. For details, refer to the instructions described below.

### Note

The plug severed from the mains lead must be destroyed, as a plug with bared flexible cord is hazardous if engaged in a live socket outlet.

## ■ Special Instructions for U.K. Model

### IMPORTANT

THE WIRES IN MAINS LEAD ARE COLOURED IN ACCORDANCE WITH THE FOLLOWING CODE:

Blue: NEUTRAL

Brown: LIVE

As the colours of the wires in the mains lead of this apparatus may not correspond with the coloured markings identifying the terminals in your plug, proceed as follows:

The wire which is coloured BLUE must be connected to the terminal which is marked with the letter N or coloured BLACK. The wire which is coloured BROWN must be connected to the terminal which is marked with the letter L or coloured RED.

Making sure that neither core is connected to the earth terminal of the three pin plug.

## Information for Users on Collection and Disposal of Old Equipment and Used Batteries



These symbols on the products, packaging, and/or accompanying documents mean that used electrical and electronic products and batteries should not be mixed with general household waste.

For proper treatment, recovery and recycling of old products and used batteries, please take them to applicable collection points, in accordance with your national legislation and the Directives 2002/96/EC and 2006/66/EC.



By disposing of these products and batteries correctly, you will help to save valuable resources and prevent any potential negative effects on human health and the environment which could otherwise arise from inappropriate waste handling.



For more information about collection and recycling of old products and batteries, please contact your local municipality, your waste disposal service or the point of sale where you purchased the items.



### [Information on Disposal in other Countries outside the European Union]

These symbols are only valid in the European Union. If you wish to discard these items, please contact your local authorities or dealer and ask for the correct method of disposal.

Pb

### Note for the battery symbol (bottom two symbol examples):

This symbol might be used in combination with a chemical symbol. In this case it complies with the requirement set by the Directive for the chemical involved.

For more detailed information, refer to the Owner's Manual on the CD-ROM. To view the Owner's Manual, click on "English" in the screen displayed automatically when you insert the CD-ROM into your PC, or click on the model name if the screen to select models is displayed, and then click on "English" in the next screen. Then, follow the onscreen instructions.

If the screen is not displayed automatically, open the "index.html" in the CD-ROM.

**Caution: Do not attempt to play this CD-ROM in an audio player.**



The Owner's Manual contained in the CD-ROM can be downloaded from the following website.

<http://download.yamaha.com/>

### About this Quick Reference Guide

The Quick Reference Guide provides instructions for connecting a TV and BD/DVD player to the unit, applying settings, and playing content. For more information on operations, refer to the Owner's Manual in the supplied CD-ROM.

Read the safety instructions described in this booklet before using the unit. For instructions on how to operate or set the external devices, refer to the owner's manual supplied with each device.

-  indicates supplementary explanations for better use.
-  indicates precautions for use of the unit and its feature limitations.

## Supplied accessories

Before connecting, make sure you have received all of the following items.

Remote control



Batteries  
(AAA, R03, UM-4; x2)

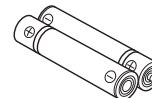

Optical cable  
(1.5 m (4.9 ft))



Accessories for mounting the unit on a wall

Template



Brackets (x2)

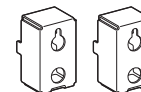

Screws (M4 x 12mm; x4)



Owner's Manual CD-ROM

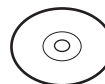

Quick Reference Guide  
(this booklet)



MusicCast Setup Guide



### Devices and cables required for connection

- TV
- BD/DVD player
- HDMI cables (x2)

## Preparing remote control

Before installing batteries or using the remote control, be sure to read battery and remote control precautions in this booklet.

### Installing the batteries

Peel off the protection sheet before use.

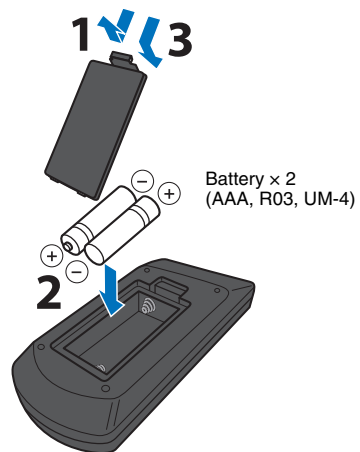
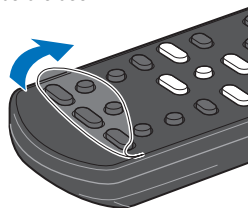

### Operation range

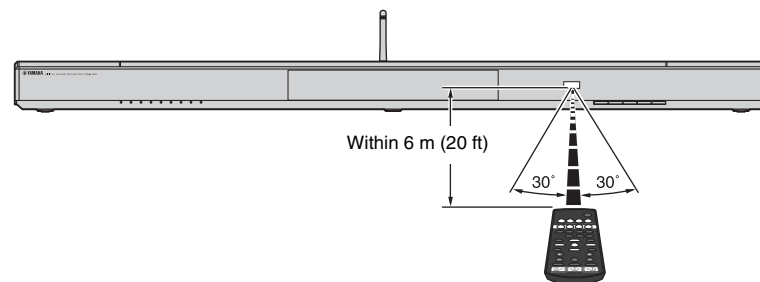

## 1 Installation

Place the unit on a flat surface. When installing this unit on a rack behind which there is limited space, for example, it may be easier to connect external devices to this unit first. See page 10 for information regarding the connection of external devices.

### Notes

- Be sure to install this unit on a large, stable stand where it does not fall subject to vibrations, such as from an earthquake, and where it is out of the reach of children.
- The unit's speakers are not magnetically shielded. Do not install hard disk drives or similar devices near the unit.
- Do not stack the unit directly on top of other playback devices, or vice versa. Heat and vibrations may result in damage or malfunction.

## Recommended place for installation

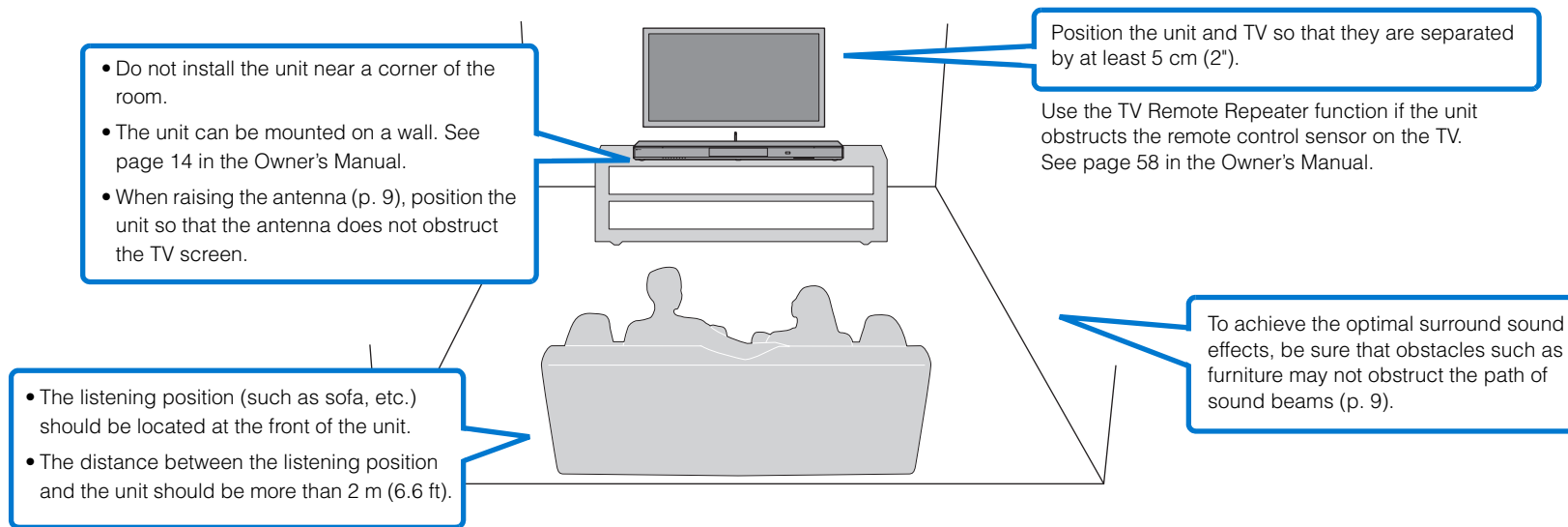



## Unit installation position and surround sound effects

The unit achieves surround sound by reflecting sound beams off walls.

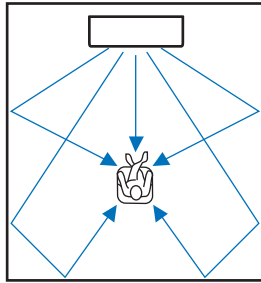

Effective surround effect may not be achieved in the following environment.

- Sound beams are blocked by obstacles such as furniture.
- The room size is not within the following dimensions;
  - Width: 3 meters to 7 meters (9.8 ft to 23 ft)
  - Depth: 3 meters to 7 meters (9.8 ft to 23 ft)
  - Height: 2 meters to 3.5 meters (6.6 ft to 11.5 ft)
- Listening position is too close to the unit.
- The unit is installed too close to the left or right wall.
- The unit is installed in the corner of the room.
- There is no wall for reflecting sound beam on the path of the sound beams.



- The optimum surround sound effect is achieved by setting a position according to the installation position of the unit. For details, refer to "[3] Surround sound effect for the installation position" (p. 12).

## Raising the antenna

Raise the antenna on the rear panel of the unit when connecting a wireless router (access point) to use a network.

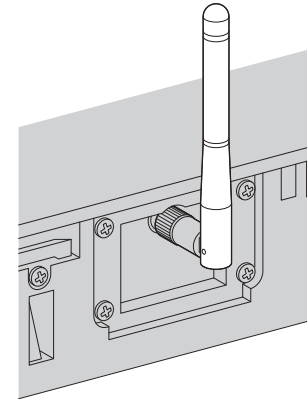

Hold the base of the antenna while raising it to its upright position.



- Do not apply excessive force on the antenna. Doing so may damage it.
- Be sure to check the direction in which the antenna moves, and angle it in the proper direction.
- Do not remove the antenna.



- For details on the wireless connection, refer to page 32 in the Owner's Manual.

## 2 Connections

### Connecting a TV and BD/DVD player

For the cable connection, follow the procedure below. See page 16 in the Owner's Manual when connecting other playback devices such as a game console.

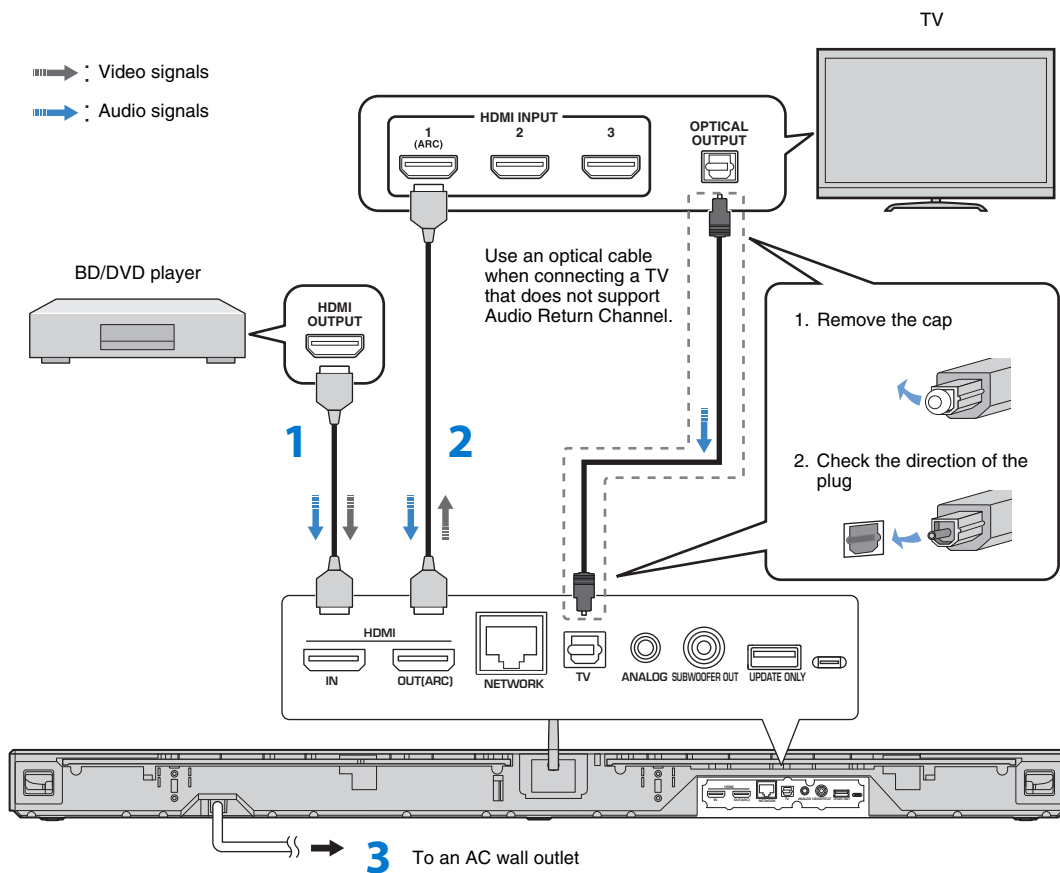

#### 1 HDMI cable (optional)

The digital audio/video signals from the BD/DVD player are input to this unit.

#### 2 HDMI cable (optional)

Digital video from the BD/DVD player is displayed on the TV.



- This unit supports HDCP version 2.2, a copy protection technology. To enjoy playback of 4K video, connect the unit to the HDMI IN jack (one compatible with HDCP 2.2) on an HDCP 2.2-compliant TV.

#### 3 To an AC wall outlet



##### Audio Return Channel (ARC) supported TV

- Connect an HDMI cable to the audio return channel supported jack (the jack with "ARC" indicated) on TV.
- Enable the HDMI control function of this unit to activate the Audio Return Channel (ARC). See page 51 in the Owner's Manual.

##### What is Audio Return Channel (ARC)?

- A function transmits digital audio signal output from TV to this unit through an HDMI cable. By this function, an optical cable to connect TV and this unit is not needed.



For a wired network connection, connect one end of the network cable to the NETWORK jack on the rear panel of the unit and the other end to a router. For details, see page 31 in the Owner's Manual.

## Turning on the unit

### 1 Press the key.

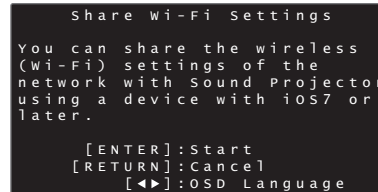
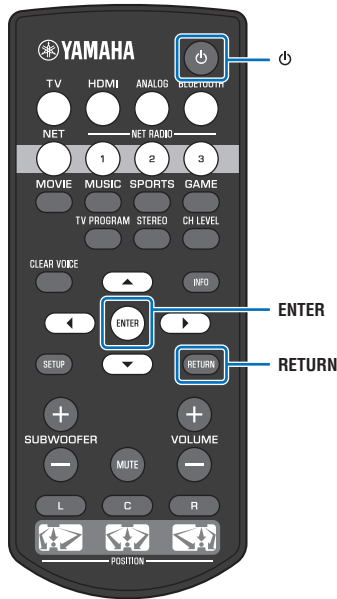
When the unit is turned on for the first time after purchase, the  indicator on the front panel will flash slowly. The screen below will be displayed on the TV when the TV is turned on.



- When the screen is not displayed, use the input button on the TV's remote control to switch input so that video input from this unit is displayed. When this unit is connected to the TV as shown on page 10, select "HDMI 1".
- The language used for menu display (OSD Language) can be selected from the screen shown above. Use the  key to select the language, and follow the on-screen instructions. The OSD language can also be changed from the setup menu at any time. Press and hold the SETUP key until the "OSD Language" menu is displayed on the TV, and use the  key to select the language. Press the SETUP key to exit the setup menu.

While this screen is displayed, an iOS device (such as an iPhone) can be used to easily connect the unit to a wireless network. Follow the procedure "Connecting the unit to a wireless network" on this page.

If you will not use an iOS device to connect to a wireless network, press the RETURN key and proceed to "[3] Surround sound effect for the installation position".



- This screen will not be displayed and the  indicator will not flash if the unit is connected to a router via its NETWORK jack (wired connection).
- See page 31 in the Owner's Manual for wireless network connection methods other than "Share Wi-Fi Settings", or for more information regarding wired and wireless networks.

## Connecting the unit to a wireless network

### 1 Press the ENTER key.

The screen below is displayed.



- You need iOS device with iOS 7.1 or later.
- Before proceeding, confirm that your iOS device is connected to a wireless router (access point).

### 2 Press the ENTER key.

### 3 Display the Wi-Fi setup screen on the iOS device and select the unit from "SETUP A NEW AIRPLAY SPEAKER...".

iOS (an example of English version)

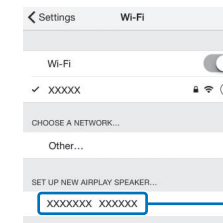

The name of the unit

#### 4 Select the network (access point) of which you want to share the settings with the unit.

iOS (an example of English version)

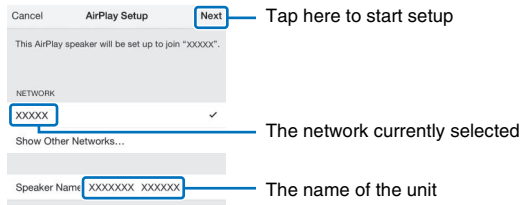

- You can use this function to connect to a wireless network at any time by selecting "Share Wi-Fi Settings (iOS)" from the setup menu. However, be aware that if a different wireless network, or a *Bluetooth* device, has already been configured, doing so will erase any previous settings.

### 3 Surround sound effect for the installation position

The surround sound is achieved by reflecting the sound beams off walls as shown in the illustration below. For optimum surround effect, turn on the unit and select the POSITION key according to the installation position of the unit.

#### 1 Hold down the POSITION key that corresponds to the installation position of the unit for more than 3 seconds.

The indicators on the front panel flash according to the set position.

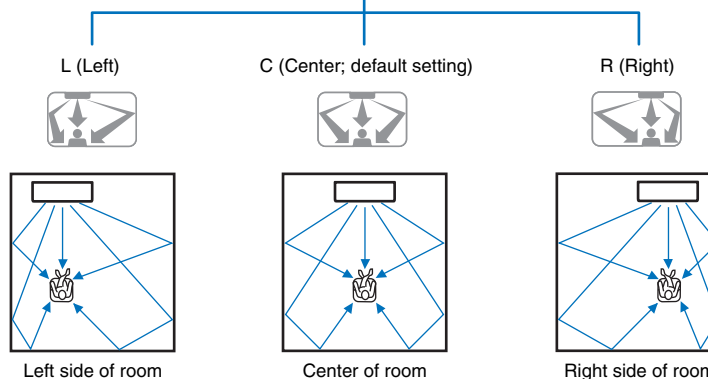
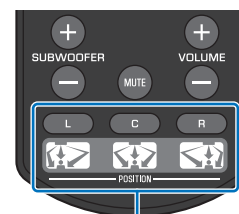
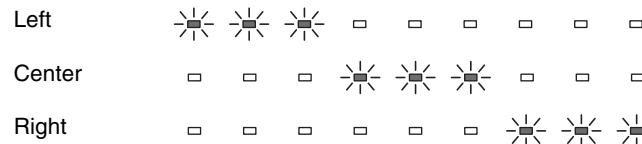

## 4 Playback

### Enjoying TV

- 1 Select the desired TV channel.
- 2 Press the TV key.



- When audio is output from the TV speaker, set TV's audio output to any option other than TV. See the instructions manual of TV for more information.
- **HDMI control function**  
You can use the TV remote control to operate this unit if your TV supports the HDMI control function. See page 20 in the Owner's Manual.

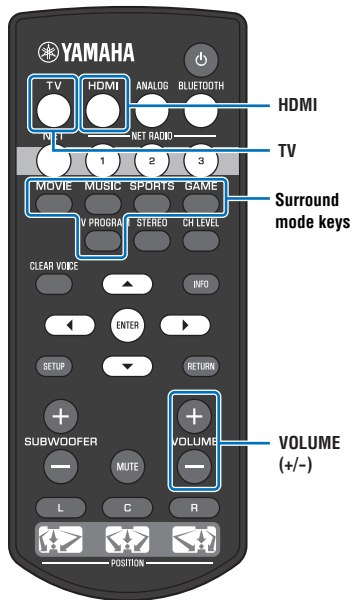

### Playing a DVD or BD

The following explains the playback procedure when this unit is connected to the TV and BD/DVD player as shown in "Connecting a TV and BD/DVD player" (p. 10).

- 1 Turn on the TV and BD/DVD player connected to this unit.
- 2 Press the HDMI key to select the BD/DVD player as the input source.

Indicator on the front panel  
  
 Glows

- 3 Use the TV's remote control to switch the TV's input to HDMI 1.
- 4 Play back a DVD or BD on the BD/DVD player.

- 5 Press the VOL (+/-) key to adjust the volume.

When the volume is adjusted, indicators on the front panel indicate volume level.

The number of lighted indicators increases when the volume is turned up, and decreases when the volume is turned down.

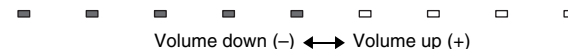

- 6 Press one of the surround mode keys according to your preferences.

See page 23 in the Owner's Manual for details.



**When this unit does not play back, check the following**

- The unit and BD/DVD player are connected correctly.
- The audio output settings of the BD/DVD player is set to digital sound output (bitstream).
- The TV's input is switched to this unit.

The unit is equipped with a number of other functions not described in this booklet. See the Owner's Manual for details.

**Main features**

- The ability to play audio from a *Bluetooth* device
- The ability to play an audio source over a network
- Dedicated MusicCast CONTROLLER and HOME THEATER CONTROLLER (WLAN) apps

**Important Notice: Guarantee Information for  
customers in EEA\* and Switzerland****English**

For detailed guarantee information about this Yamaha product, and Pan-EEA\* and Switzerland warranty service, please either visit the website address below (Printable file is available at our website) or contact the Yamaha representative office for your country. \*EEA:European Economic Area

<http://europe.yamaha.com/warranty/>

