



RX-A3000

AV Receiver

Owner's Manual

English for Oceania

BEFORE USE

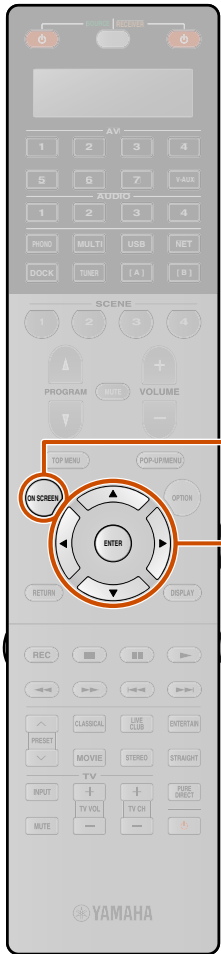

About this manual

- Some features are not available in certain regions.
- This manual is created prior to production. Design and specifications are subject to change in part as a result of improvements, etc. In case of differences between the manual and product, the product has priority.
- “[8]ON SCREEN” (example) indicates the name of the parts on the remote control. Refer to the “Remote control” (p. 12) for the information about each position of the parts.
- indicates that the reference is in the footnote. Refer to the corresponding numbers on the bottom of the page.
- indicates the page describing the related information.
- Click on the “ ” at the bottom of the page to display the corresponding page in “Part names and functions.”

- Front panel
- Rear panel
- Front panel display
- Remote control

Supplied accessories

Check that you received all of the following parts.

- Remote control
- Simplified Remote Control
- Batteries (AAA, LR03, UM-4) x 4
- Power cable
- YPAO microphone
- AM loop antenna
- Indoor FM antenna
- Microphone base

Language selection

This procedure allows you to select the language of menus and messages on the TV screen.

- 1 Press [8]ON SCREEN to display the ON SCREEN menu.

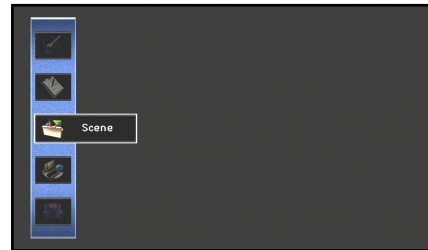

- 2 Press [9]Cursor Δ / ∇ to select “Setup” and press [9]ENTER.

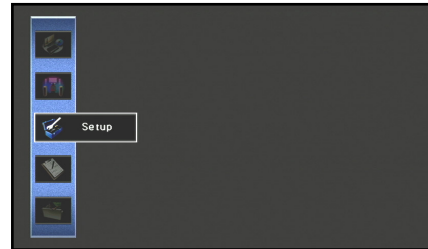

- 3 Press [9]Cursor \leftarrow / \rightarrow to select the “Language” and press [9]ENTER.

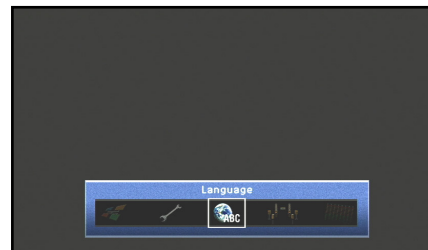

- 4 Press [9]Cursor Δ / ∇ to select the favorite language from the following options.

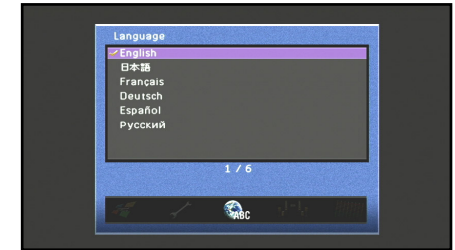

English (English), 日本語 (Japanese), Français (French), Deutsch (German), Español (Spanish), Русский (Russian)

- 5 Press [8]ON SCREEN to close the ON SCREEN menu.



CONTENTS

INTRODUCTION

| | |
|---|----------|
| Features and capabilities | 5 |
| Using the TV OSD to operate the unit | 6 |
| Basic operation of OSD menu | 6 |
| Viewing or modifying content for the current input source <Content window> | 6 |
| Configuring settings for this unit <ON SCREEN menu> | 6 |
| Adjust settings for each input source <Option menu> | 7 |
| Part names and functions | 8 |
| Front panel | 8 |
| Front panel with the cover opened | 9 |
| Rear panel | 10 |
| Front panel display | 11 |
| Remote control | 12 |
| Remote control with the cover opened | 13 |
| On-screen display | 14 |

CONNECTIONS

| | |
|--|-----------|
| Connecting speakers | 15 |
| Speaker channels and functions | 15 |
| Speaker layout | 16 |
| Connecting speakers and subwoofers | 20 |
| Advanced speaker configuration | 23 |
| Speaker layout utilizing an external power amplifier | 23 |
| Connecting an external amplifier | 27 |
| Connecting external components | 28 |
| Jacks and cables | 28 |
| Connecting a TV monitor | 29 |
| Connecting BD/DVD players and other devices | 32 |
| Connecting game consoles or video camcorders | 37 |
| Connecting a multi-format player or an external decoder | 37 |
| Connecting a SCENE link playback-compatible device | 38 |

| | |
|--|----|
| Using the Trigger function to link external component power | 38 |
| Connecting audio/video recording devices | 39 |
| Connecting to the network | 39 |
| Connecting a USB storage device | 40 |

| | |
|---|-----------|
| Connecting the FM/AM antennas | 41 |
| Setting up the speaker parameters automatically (YPAO) | 42 |

PLAYBACK

| | |
|---|-----------|
| Basic playback procedure | 51 |
| Changing input settings with a single key (SCENE function) | 53 |
| Selecting the SCENE suitable for the external component | 53 |
| Enjoying favorite sound field effect | 54 |
| Selecting sound programs and sound decoders | 54 |
| Enjoying surround sound with the CINEMA DSP function | 54 |
| Enjoying unprocessed playback (Straight decoding mode) | 55 |
| Enjoying Hi-Fi Sound Quality (Pure Direct Mode) | 56 |
| Enjoying stereo playback | 56 |
| Enjoying compressed music source with better sound quality (Compressed Music Enhancer) | 56 |
| Sound programs | 57 |
| Using the TV display to control this unit | 59 |
| Basic operations via the TV screen display | 59 |
| Configuring settings specific to an individual input source (Option menu) | 61 |
| Option menu display and setup | 61 |
| Option menu | 62 |
| Confirming and operating input sources from the content window | 65 |
| Displaying the content window on the TV screen | 65 |
| Switching the display between the Now Playing view and the Browse view | 65 |

| | |
|--|-----------|
| FM/AM tuning | 66 |
| Selecting a frequency for reception (Normal tuning) | 66 |
| Navigating the FM/AM tuner from the content window | 67 |
| Playing back tunes on the PC | 69 |
| Windows Media Player setup | 69 |
| Playback of PC music contents | 69 |
| Playing back tunes on the USB storage devices | 71 |
| Playback of the USB storage device | 71 |
| Listening to the Internet Radio | 73 |
| Listening to Internet Radio | 73 |
| Using shortcut function | 75 |
| Playing back tunes from your iPod™/iPhone™ | 76 |
| Connecting the Universal Dock for iPod | 76 |
| Controlling an iPod™/iPhone™ | 76 |
| Playing iPod™/iPhone™ from the menu screen (Menu browse control) | 77 |
| Operating basic playback functions via the remote control (Simple remote control) | 78 |
| Playing iPod™/iPhone™ with wireless connection | 78 |
| Playing back tunes from Bluetooth™ components | 80 |
| Connecting a Yamaha Bluetooth Wireless Audio Receiver | 80 |
| Pairing Bluetooth™ components | 80 |
| Using Bluetooth™ components | 81 |
| Controlling this unit by using the Web browser (Web Control Center) | 82 |
| Displaying and Operating Web Control Center | 82 |

SETUP

| | |
|--|------------|
| Configuring input sources (Input menu) | 84 |
| Configuring input sources | 84 |
| Input menu | 85 |
| Editing the SCENE function (Scene menu) | 87 |
| Editing a scene | 87 |
| Scene menu | 88 |
| Simple registering as the SCENE | 89 |
| Setting sound program parameters (Sound Program menu) | 90 |
| Editing sound programs | 90 |
| CINEMA DSP parameters | 91 |
| Parameters usable in certain sound programs | 93 |
| Parameters usable in surround decoder | 94 |
| Setting various functions (Setup menu) | 95 |
| Operating the Setup menu | 95 |
| Setup menu | 96 |
| Manages settings for speakers | 96 |
| Setting the audio output function of this unit | 100 |
| Setting this unit's video output function | 102 |
| Setting HDMI functions | 104 |
| Adjusting this unit's network parameters | 106 |
| Setting this unit's multi-zone function | 107 |
| Making the receiver easier to use | 109 |
| Language | 112 |
| Confirming information of this unit (Information menu) | 113 |
| Selecting information | 113 |
| Controlling the remote control to operate various functions | 115 |
| Keys connecting external components | 115 |
| Customizing the remote control | 116 |
| Setting remote control codes | 116 |
| Programming from other remote controls | 118 |
| Changing source names in the display window | 120 |
| Macro programming features | 121 |
| Clearing configurations | 122 |

| | |
|--|------------|
| Simplified remote control | 124 |
| Extended functionality that can be configured as needed (Advanced Setup menu) | 125 |
| Displaying/Setting the Advanced Setup menu | 125 |
| Setting the impedance of speakers | 125 |
| Remote sensor | 126 |
| Avoiding crossing remote control signals when using multiple Yamaha receivers | 126 |
| Changing TV format | 127 |
| Removing HDMI video output up-scaling limits | 127 |
| Recovery and backup of the system settings | 127 |
| Initializing various settings for this unit | 127 |
| Firmware update | 128 |
| Firmware version | 128 |

| | |
|--|------------|
| Using the HDMI Control function | 129 |
| Enjoying the contents in another room | 133 |
| Connecting Zone2, Zone3 or Zone4 | 133 |
| Controlling Zone2, Zone3 or Zone4 | 135 |
| Enjoying the music in all rooms | 136 |

APPENDIX

| | |
|--|------------|
| Troubleshooting | 137 |
| General | 137 |
| HDMI™ | 139 |
| Tuner (FM/AM) | 140 |
| USB and Network | 141 |
| iPod™/iPhone™ | 142 |
| Bluetooth™ | 143 |
| Remote control | 143 |
| Glossary | 144 |
| Audio information | 144 |
| Sound program information | 145 |
| Video information | 146 |
| Compatibility of the input and output video signals | 146 |

| | |
|-----------------------------------|------------|
| Information on HDMI™ | 147 |
| About trademarks | 148 |
| Specifications | 149 |
| Index | 151 |

INTRODUCTION

Features and capabilities

| | |
|---|-----------|
| ■ Built-in high-quality, high-power 7-channel amplifier | |
| ■ Multi-channel speaker configuration capability | |
| – 2- to 7.1-channel speaker configurations | 16 |
| – Presence speaker connections for playback with a richer sound field effect | 20 |
| – Bi-amplification connections for high-quality playback | 21 |
| – External amplifier connections for high-quality playback and expansion of channels | 23 |
| – Speaker impedance configuration | 21 |
| ■ HDMI compatibility | |
| – 8 HDMI input jacks (7 on the rear, 1 on the front) supporting 3D video signal input | 32 |
| – 2 selectable HDMI output jacks supporting Audio Return Channel and 3D video signal | 30 |
| ■ Automatic setup for speaker acoustic parameters (YPAO - Yamaha Parametric Room Acoustic Optimizer) | 42 |
| ■ Extensive inputs (max. 13) for external playback components | |
| – BD/DVD/CD player connection | 32 |
| – Game console / video camcorder connection | 37 |
| – Multi-format player / external decoder connection | 37 |
| – iPod/iPhone wired connection | 76 |
| – iPod/iPhone wireless connection | 78 |
| – Bluetooth component connection | 80 |
| ■ 1-button input/sound program/setting switching (SCENE function) | 53 |
| ■ Built-in sound programs and surround decoders for playback variety of sources | |
| – Spatial sound playback with sound field effects (CINEMA DSP) | 54 |
| – Playback with no sound field effects (straight decoding) | 55 |
| – High-fidelity sound playback (Pure Direct) | 56 |
| – Enhanced sound playback for compressed sources (Compressed Music Enhancer) | 56 |
| ■ Tuner playback | |
| – FM/AM broadcast | 66 |
| ■ Playback and control via network | |
| – Playback of music on the PC and DLNA server | 69 |
| – Internet radio service playback | 73 |
| – Control this unit via network (Web Browser Control) | 82 |
| ■ Playback of music on the USB storage devices | 71 |
| ■ Sophisticated on-screen display (OSD) for easy operation | |
| – Selection of input sources, scenes, and sound programs | 59 |
| – Navigation for the current input source (content window) | 65 |
| – Setup for this unit (ON SCREEN menu) | 84 |
| – Setup for each input source (Option menu) | 61 |

Most of functions can be operated with on-screen display on the TV screen. Refer to “Using the TV OSD to operate the unit” on the following pages for information on functions that can be controlled using the on-screen display.

| | |
|--|------------|
| ■ Customizable remote control | |
| – Remote control code setup for operation of external components | 115 |
| – Learning function from other remote controls | 118 |
| – Programming macro for a series of operations | 121 |
| ■ Multi-room listening capability (Zone2/Zone3/Zone4) | 133 |



Using the TV OSD to operate the unit

This unit features a sophisticated on-screen display (OSD) for the TV screen. The OSD is designed to enable visual guidance that simplifies operations. The OSD mainly displays the ON SCREEN and Option menus, as well as the content window that displays the content of current input sources.

Basic operation of OSD menu

| | |
|---|-----|
| ■ Select an input source, scene and sound program | |
| – Select an input source | 59 |
| – Select a scene | 59 |
| – Select a sound program | 60 |
| ■ Select a language | |
| – Change the language displayed on the TV screen <Language> | 112 |

Viewing or modifying content for the current input source <Content window>

| | |
|---|----|
| ■ Operate the FM/AM tuner | |
| – Display preset stations for selection | 67 |
| – Display information on the station currently received | 67 |
| – Perform operations such as searching for and registering stations using the screen button | 67 |
| ■ Operate the Internet radio | |
| – Display information on the station currently received | 73 |
| – Play back radio contents | 73 |
| – Bookmark Internet radio stations | 73 |
| ■ Operate the iPod music sources | |
| – Display the list of iPod music sources for selection | 77 |
| – Perform operations such as play, stop and pause using the TV screen <Menu browse control> | 77 |

Configuring settings for this unit <ON SCREEN menu>

| | |
|--|-----|
| ■ Configure an input source | |
| – Change the input source name <Rename/Icon Select> | 85 |
| – Specify a format for digital audio signals <Decoder Mode> | 86 |
| – Enhance the sound of compressed audio <Enhancer> | 86 |
| – Output a video signal input from another input source while playing a multi-channel audio signal <Video Out> | 86 |
| – Charge the iPod/iPhone when this unit is in standby mode <Standby Charge> | 86 |
| – Play music sources on a PC using external controls <DMC Control> | 86 |
| ■ Customize a scene | |
| – Register or clear settings for a selected scene <Save>, <Load>, <Reset> | 88 |
| – Turn on a Yamaha BD/DVD player or CD player connected to this unit automatically when a scene is selected <SCENE IR> | 88 |
| – Changing a scene name and icon <Rename/Icon Select> | 89 |
| ■ Adjust a sound program (sound program) | |
| – Adjust sound program parameters | 90 |
| ■ Display settings information for this unit | |
| – Display audio signal information <Audio Signal> | 113 |
| – Display video signal information <Video Signal> | 113 |
| – Display HDMI signal information <HDMI Monitor> | 113 |
| – Display network information <Network> | 114 |
| – Display system information <System> | 114 |
| – Display Zone information <Zone> | 114 |



■ Adjust acoustic parameters to match your speakers and listening environment

- Specify speaker acoustic parameters automatically (Yamaha Parametric Room Acoustic Optimizer - YPAO).....42
- Set up this unit's speaker configuration simply <Power Amp Assign>97
- Specify settings for each speaker <Configuration>97
- Control volume control for each speaker <Level>99
- Apply speaker distance settings <Distance>99
- Control equalizer sound quality <Parametric EQ>.....99
- Adjust test tone speaker <Test Tone>100

■ Adjust audio signals output from this unit

- Correct lag between audio and video signals <Lipsync>101
- Select a dynamic range adjustment method <Dynamic Range>101
- Specify the maximum volume <Max Volume>101
- Specify the initial volume <Initial Volume>.....101
- Restrict the video signals during the Pure Direct Mode <Pure Direct Mode>.....101
- Adjust DSP effect and volume level <Adaptive DSP Level>.....102

■ Adjust video signals output from this unit

- Convert analog video signal to another type of signal <Analog to Analog Conversion>102
- Specify the resolution and aspect ratio of video signals and adjust video quality <Processing>.....102

■ HDMI settings

- Assign the audio input source for the TV <TV Audio Input>.....105
- Listen to TV audio with HDMI cable connection <ARC (Audio Return Channel)>.....104
- Transmit HDMI audio/video to the TV during standby mode <Standby Through>105
- Change the output destination of HDMI input audio signals <Audio Output>.....105

■ Network settings

- Specify this unit's IP address <IP Address>.....106
- Accept the commands over a LAN network when this unit is in the standby mode <Network Standby>106
- Specify the mac address filter for this unit <MAC Address Filter>106

■ Enable listening in multiple rooms (multi-zone function)

- Adjust Zone2/Zone3 volume <Zone2 Set/Zone3 Set>107
- Display the Zone2/Zone3/Zone4 menu on the TV <Monitor Out Assign>108
- Rename each zone or scene <Zone2 Scene Rename/Zone3 Scene Rename/Zone4 Scene Rename/Zone Rename>109

■ Specify other functions for this unit

- Enter standby mode automatically when no operations are performed <Auto Power Down>110
- Assign the other input to the selected input source <Input Assignment>110
- Adjust the brightness of the front panel display <Dimmer>111
- Change the wall paper displayed on the TV screen <Wall Paper>.....111
- Specify the function of the TRIGGER OUT jack for controlling external components <Trigger Output1/Trigger Output2>.....111
- Prohibit changes to settings <Memory Guard>.....112

Adjust settings for each input source <Option menu>

- Adjust bass and treble levels <Tone Control>63
- Enable low-volume background music <Adaptive DRC>63
- Enjoying more spatial sound fields <CINEMA DSP 3D Mode>.....63
- Adjust the vertical position of dialogues <Dialogue Lift>63
- Select the 5.1-channel signal playback method <Extended Surround>63
- Adjust the volume of input sources <Volume Trim>.....64
- Selecting a video adjustment preset <Video Adjustment>64
- Selecting audio input jacks <Audio Select>.....64
- Shuffle or repeat the song <Shuffle/Repeat>.....64
- Connect / Disconnect Bluetooth component to this unit <Connect/Disconnect>64
- Pairing Bluetooth component with this unit <Pairing>64



Part names and functions

Front panel

① **MAIN ZONE ⏻ (Power)**

Switches this unit between on and standby mode.

② **HDMI Through/iPod Charge indicator**

Lights up in any of the following cases while the unit is in standby mode.

- When the Standby Through function is enabled and audio/video from an external component connected with HDMI is output to a TV during standby mode (p. 105).
- When an iPod/iPhone, which is placed in the Universal Dock for iPod, is charging while the unit is in standby mode (p. 86). This indicator also lights up when the Yamaha Wireless System for iPod is connected to this unit (p. 78).

③ **Front panel display**

Displays information on this unit (p. 11).

④ **PURE DIRECT**

Switches this unit to Pure Direct Mode (p. 56).

⑤ **INPUT selector**

Selects an input source from which to playback. Rotate this selector to cycle through the input sources in order.

⑥ **VOLUME**

Adjusts the volume level.

■ Opening and closing the front panel door

To use controls or jacks behind the front panel door, gently press the bottom of the door to open it. Keep the door closed when not using controls or jacks behind the front panel door.

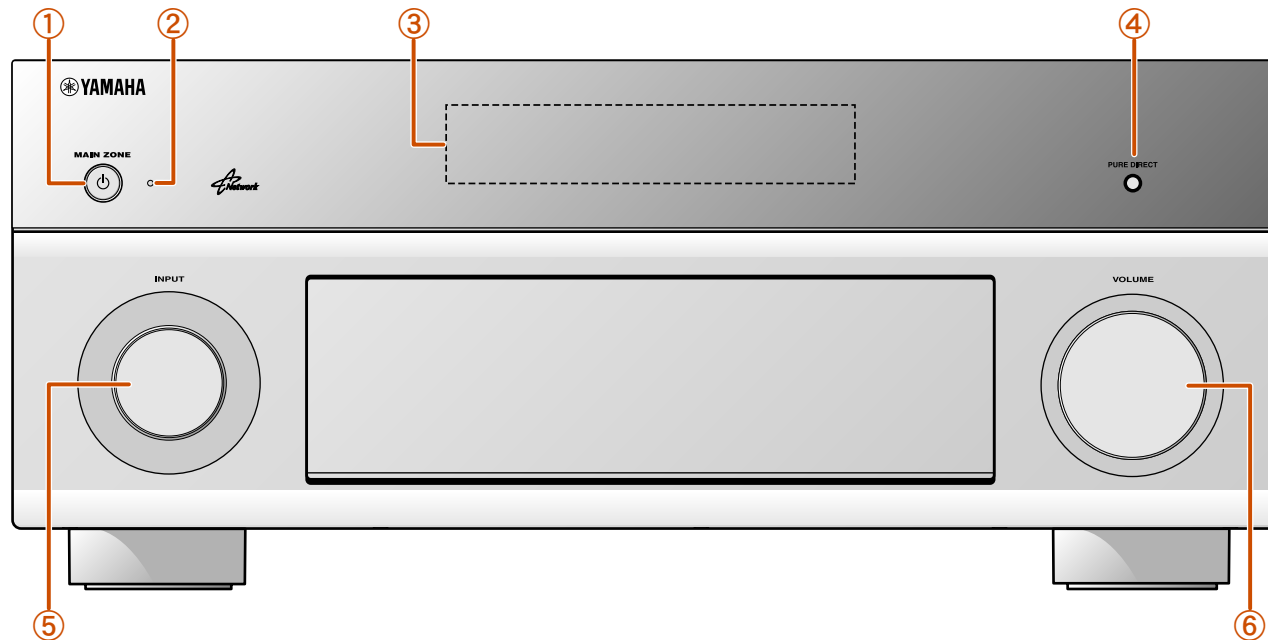
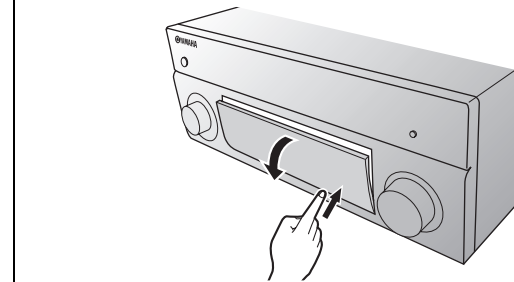

Continues to the next page



Front panel with the cover opened

- ⑦ **ON SCREEN**
Turns on and off the ON SCREEN menu.
- ⑧ **OPTION**
Turns on and off the Option menu ([p. 61](#)).
- ⑨ **TONE/BALANCE**
Adjusts high-frequency/low-frequency output of speakers/headphones in each zone ([p. 52, p. 135](#)).
- Adjusts the balance of the volume of the left and right channels in Zone2, Zone3 or Zone4 ([p. 135](#)).
- ⑩ **STRAIGHT**
Changes a sound program to straight decoding mode ([p. 55](#)).
- ⑪ **PROGRAM** </>
Selects a sound program ([p. 54](#)). Press the left or right key repeatedly to cycle through sound programs.
- ⑫ **SCENE**
Switches the input source, the sound program, and the HDMI OUT with a single button ([p. 53, p. 87](#)). When this unit is in standby mode, press this key to switch on.

- ⑬ **MULTI ZONE**
ZONE2/ZONE3/ZONE4
Switches to enable/disable the audio and video output to Zone2, Zone3 and/or Zone4 ([p. 107, p. 133](#)).
- ZONE CONTROLS**
Switches to Zone2, Zone3 or Zone4 operation mode. This unit, or its remote control, can be used to select input sources or adjust volume for an external amplifier in another room or the built-in amplifier for speakers in another room ([p. 135](#)).
- ⑭ **INFO**
Changes the information displayed on the front panel display ([p. 11](#)).
- ⑮ **MEMORY**
Registers FM/AM stations as preset stations ([p. 66](#)). 🌱1
- ⑯ **FM/AM**
Sets the FM/AM tuner band to FM or AM ([p. 66](#)). 🌱1
- ⑰ **PRESET** </>
Selects an FM/AM preset station ([p. 67](#)). 🌱1

- ⑱ **Cursor** △ / ▽ / ◀ / ▶, **ENTER, RETURN**
Cursor △ / ▽ / ◀ / ▶ Select menu items and change settings when menus, etc., are displayed.
ENTER RETURN Confirms a selected item.
Returns to the previous screen when menus are displayed, or close the menu.
- ⑲ **USB port**
For connecting a USB memory device or USB portable audio player ([p. 40](#)).
- ⑳ **DISPLAY**
Switches the display between the Now Playing view and the Browse view.
- ㉑ **YPAO MIC jack**
Connect the supplied YPAO microphone and adjust the speaker balance automatically ([p. 42](#)).
- ㉒ **PHONES jack**
For plugging headphones in. Sound effects applied during playback can also be heard through the headphones.
- ㉓ **VIDEO AUX jacks**
For connecting game consoles to this unit temporarily ([p. 37](#)).
- ㉔ **TUNING/CH** <</>>
Changes FM/AM tuner frequencies ([p. 66](#)). 🌱1

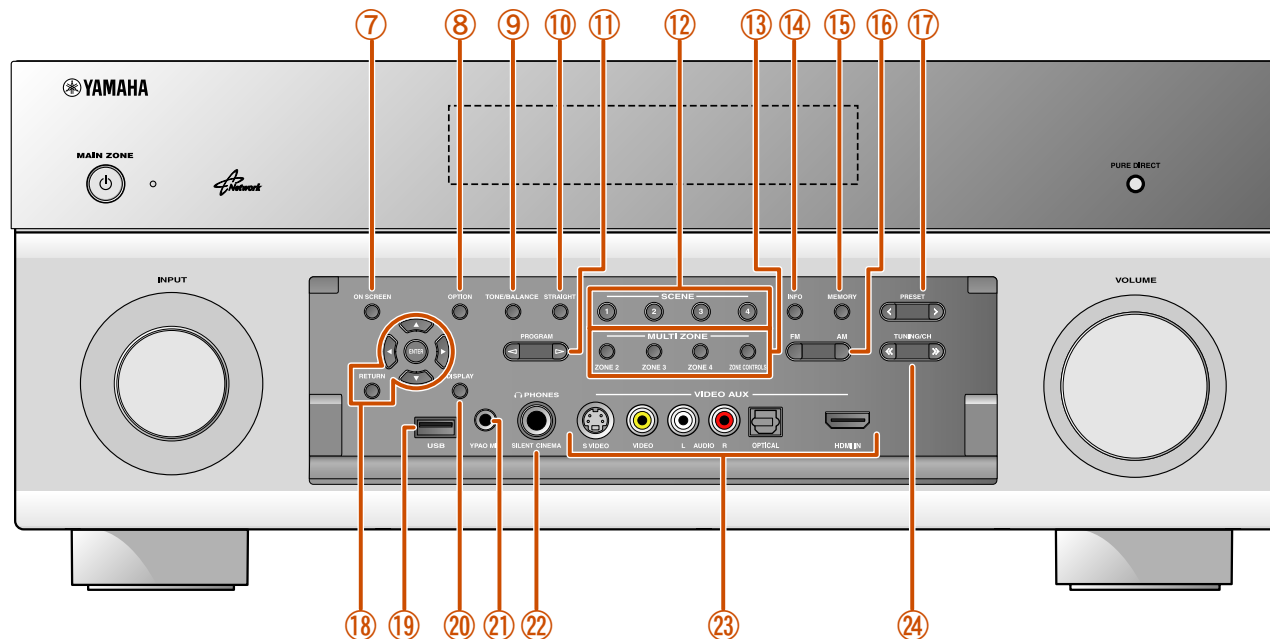

🌱 1 : Usable when you have selected TUNER input.

Rear panel

① **PHONO jacks**

For connecting a turntable (p. 36).

② **DOCK jack**

For connecting an optional Universal Dock for iPod (such as YDS-12), Wireless System for iPod (YID-W10), or Bluetooth Wireless Audio Receiver (YBA-10) (p. 76, p. 78, p. 80).

③ **NETWORK port**

For connecting to a network (p. 39).

④ **HDMI OUT 1-2 jacks**

For connecting an HDMI-compatible TV to output audio/video signals (p. 30).

⑤ **MON.OUT/ZONE OUT jacks (S-VIDEO/VIDEO jacks)**

For connecting a TV capable of receiving video input, and outputting video signals to it (p. 30, p. 31).

⑥ **COMPONENT VIDEO jacks**

For connecting external components that support component video output for video signal reception (p. 33).

⑦ **HDMI input jacks**

For connecting external components equipped with HDMI-compatible outputs to receive audio/video signals (p. 32).

⑧ **MONITOR OUT/ZONE OUT jacks (COMPONENT VIDEO jacks)**

For connecting TV that are compatible with component video signals, using three cables to output video signal (p. 30).

⑨ **REMOTE IN/OUT1-2 jacks**

For connecting an external component that supports the remote control function (p. 38).

⑩ **TRIGGER OUT 1-2 jack**

For connecting an external component that supports the trigger function to operate it linked with operation of this unit (p. 38).

⑪ **RS-232C terminal**

This is a control expansion terminal for custom installation. Consult your dealer for details.

⑫ **AV1-4 jacks**

For connecting to external components equipped with audio/video outputs to receive audio/video signals (p. 33).

⑬ **ANTENNA jacks**

For connecting AM and FM antennas (p. 41).

⑭ **AV OUT jacks**

For outputting audio/video signals received when analog inputs are selected (p. 39).

⑮ **AUDIO1-4 jacks**

For connecting external components equipped with audio outputs to receive audio signals (p. 36).

⑯ **MULTI CH INPUT jacks**

For connecting a player that supports a multi-channel output (p. 37).

⑰ **ZONE OUT jacks**

Outputs sound of this unit to an external amplifier set in a different room. (p. 133).

⑱ **PRE OUT terminals**

For connecting a subwoofer with built-in amplifier or an external power amplifier (p. 22, p. 27).

⑲ **SPEAKERS terminals**

For connecting the front, center, surround and surround back speakers (p. 20). Connect the front/rear presence speakers (p. 20) or the speakers for Zone2 and Zone3 (p. 21) to the EXTRA SP jacks.

⑳ **AC IN**

For connecting the supplied power cable.

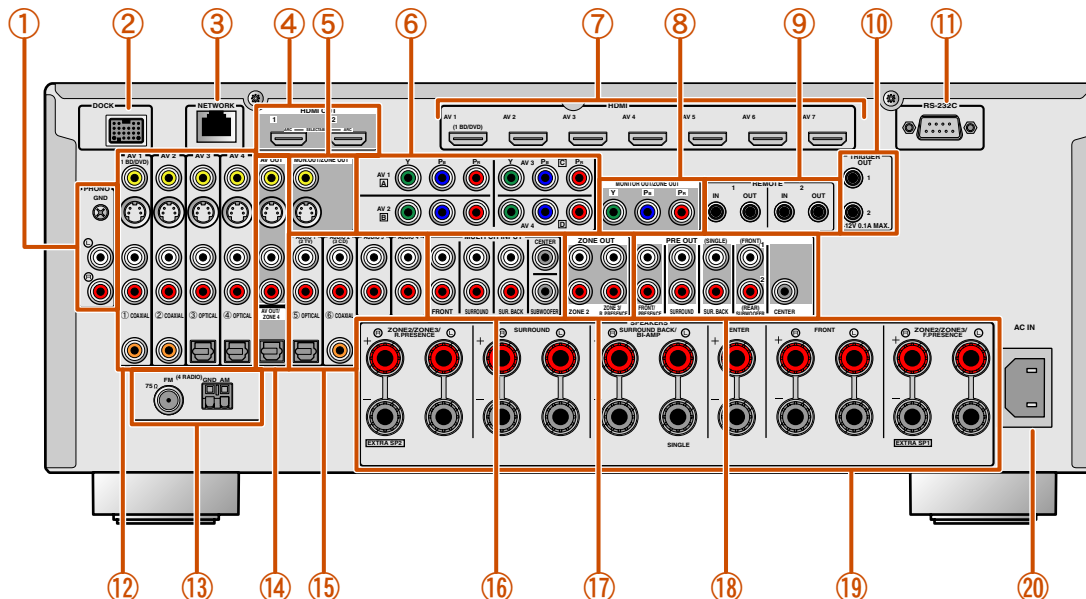

Distinguishing the input and output jacks

The area around the audio/video output jacks is marked in white to prevent connection errors. Use these jacks to output audio/video signals to a TV or other external component.

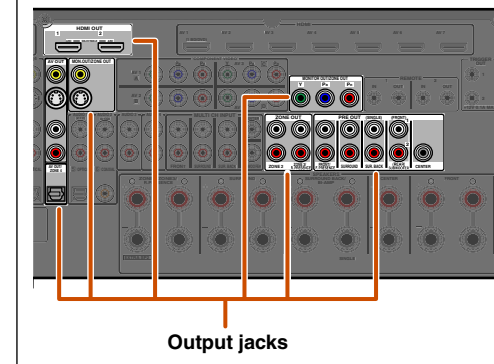

Front panel display

- ① **Tuner indicator**
Lights up according to the status of a received station (p. 66).
- ② **ZONE2/ZONE3/ZONE4 indicator**
Lights up when the audio or video output to Zone2, Zone3 or Zone4 is enabled (p. 135).
- ③ **SLEEP indicator**
Blinks when the sleep timer is on (p. 13, p. 135).
- ④ **PARTY indicator**
Lights up when the party mode is active (p. 108).
- ⑤ **Multi information display**
Displays a range of information on menu items and settings.
- ⑥ **VOLUME indicator**
Displays the current volume level.
- ⑦ **HDMI indicator**
Lights up during normal HDMI communication.
- IN indicator**
Lights up when this unit detects the external component connected to the HDMI input jack (p. 32).
- OUT 1/OUT 2 indicators**
Indicate which HDMI OUT jack outputs audio/video signals (p. 30).
- ⑧ **ENHANCER indicator**
Lights up when the Compressed Music Enhancer is active (p. 56).

- ⑨ **CINEMA DSP indicator**
Lights up when a sound field effect that uses CINEMA DSP technology is selected.
- ⑩ **CINEMA DSP 3D indicator**
Lights up when CINEMA DSP 3D is activated (p. 55).
- ⑪ **Cursor indicators**
Light up if corresponding cursors on the remote control are available for operations.
- ⑫ **MUTE indicator**
Blinks when audio is muted.
- ⑬ **Speaker indicators**
Indicate speaker terminals from which signals are output.

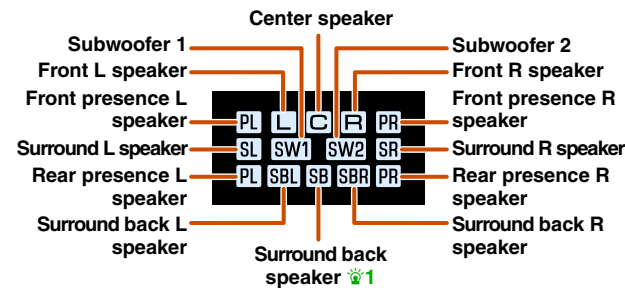

- ⑭ **ADAPTIVE DRC indicator**
Lights when the adaptive dynamic range control feature is tuned on (p. 63).

Switching information on the front panel display

The front panel can display sound programs and surround decoder names as well as the active input source. Press **INFO** repeatedly to cycle through displayed informations. 2

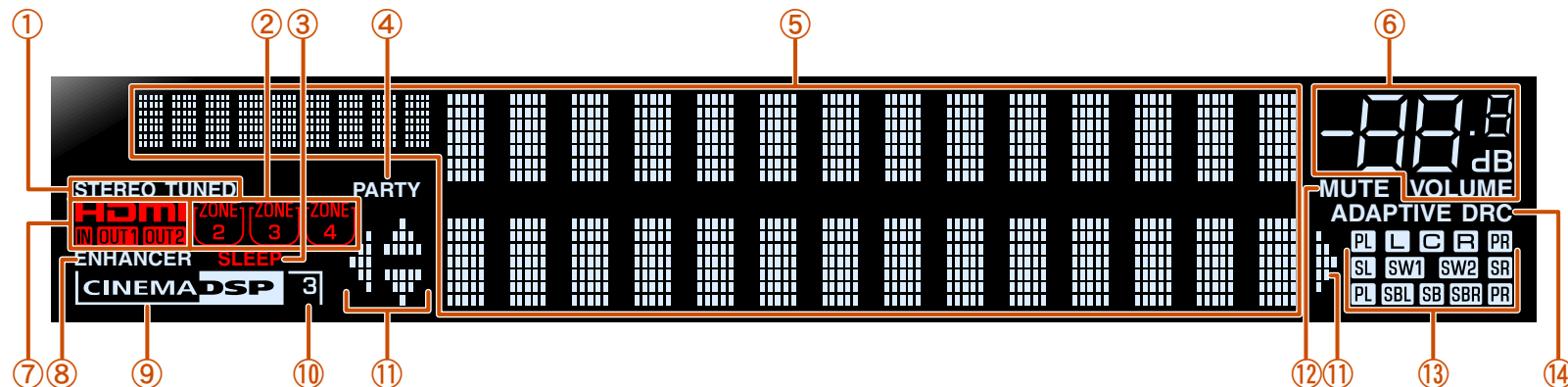
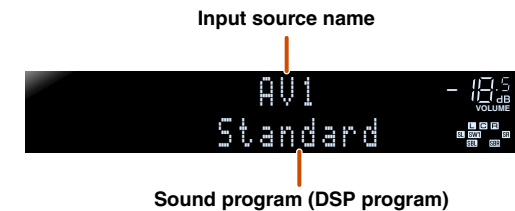

1: "SB" is displayed when using a 6.1-channel configuration only.
2: During FM/AM reception, the frequency is displayed instead of the input source.

Remote control

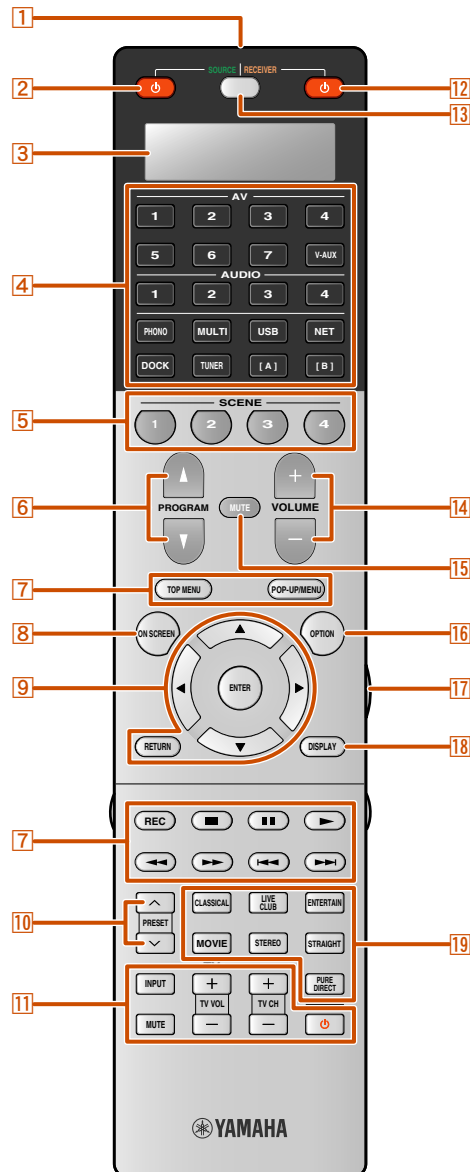

- 1 Remote control signal transmitter**
Transmits infrared signals.
- 2 SOURCE ϕ (SOURCE Power)**
Switches an external component on and off.
- 3 Display window**
Displays remote control information.
- 4 Input selector**
Select an input source on this unit from which to playback.

| | |
|----------------------|---|
| AV1-7 | AV1-7 jacks |
| V-AUX | Front panel VIDEO AUX jacks |
| AUDIO1-4 | AUDIO1-4 jacks |
| PHONO | PHONO jacks |
| MULTI | MULTI CH INPUT jacks |
| USB | A USB storage device connected to the USB port. |
| NET | Internet radio, a USB connected to the USB port, or a PC connected to the NETWORK port. |
| DOCK | A Universal Dock for iPod, Wireless System for iPod, or Bluetooth Wireless Audio Receiver connected to the DOCK jack. |
| TUNER [A]/[B] | FM/AM tuner |

Changes the external component to operate with the **7 External component operation keys** without changing inputs. 1
- 5 SCENE**
Switch the input source and the sound program with a single button ([p. 53](#)). When this unit is in standby mode, press this key to switch on.
- 6 PROGRAM Δ / ∇**
Selects a sound program ([p. 54](#)). Press the up or down key repeatedly to cycle through sound programs.
- 7 External component operation keys**
Operate recording, playback, and menu displays etc. for external components ([p. 115](#)). 1
- 8 ON SCREEN**
Turns on and off the ON SCREEN menu.
- 9 Cursor Δ / ∇ / \triangleleft / \triangleright , ENTER, RETURN**
Cursor Δ / ∇ / \triangleleft / \triangleright Select menu items and change settings when menus, etc., are displayed.
ENTER Confirms a selected item.
RETURN Returns to the previous screen when menus are displayed, or close the menu.
- 10 PRESET \wedge / \vee**
Selects a preset station when the FM/AM.
- 11 TV control keys**
Operate a monitor such as a TV.
- 12 RECEIVER ϕ (RECEIVER Power)**
Switches this unit between on and standby mode.
- 13 SOURCE/RECEIVER**
Switches remote control key function to operate this unit or an external component ([p. 115](#)). Operate an external component when this key glows green, or this unit when this key glows orange.
- 14 VOLUME +/-**
Adjust the volume level ([p. 51](#)).
- 15 MUTE**
Turns the mute function of the sound output on and off ([p. 51](#)).
- 16 OPTION**
Turns on and off the Option menu ([p. 61](#)).
- 17 LIGHT**
Lights up the silicon buttons while pressing this key.
- 18 DISPLAY**
Switches the display between the Now Playing view and the Browse view.
- 19 Sound selection keys**
Switch between the current sound field effect (sound program) and the surround decoder ([p. 54](#)).

1 : You can use **7 External component operation keys** for each input source to operate registered components. Remote control codes must be registered for each input in advance if you want to operate external components ([p. 117](#)).



Remote control with the cover opened

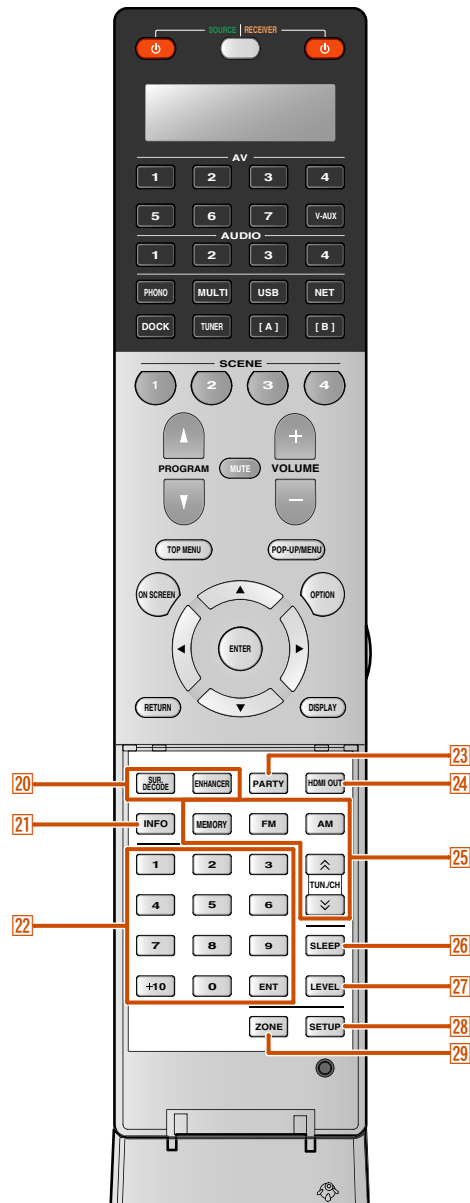

- 20 Sound selection keys**
Switch between the current sound field effect (sound program) and the surround decoder ([p. 54](#)).
- 21 INFO**
Cycles the information displayed on the front panel display (the name of the currently selected input source, the sound program, the surround decoder, the FM/AM tuner frequency, etc.).
- 22 Numeric keys**
Enter numbers.
- 23 PARTY**
Switches the party mode on and off ([p. 136](#)).
- 24 HDMI OUT**
Switches the output jack connected to an HDMI compatible TV ([p. 51](#)).
- 25 Radio control keys**
Operates the FM/AM tuner. These keys are used when using the tuner input.
MEMORY Presets radio stations.
FM Sets the FM/AM tuner band to FM.
AM Sets the FM/AM tuner band to AM.
TUN./CH Changes tuning frequencies.
- 26 SLEEP**
Switches this unit to standby mode automatically after a specified period of time has elapsed (sleep timer). Press this key repeatedly to set the time for the sleep timer function.
- 27 LEVEL**
Adjusts the output level for each speaker ([p. 99](#)).
- 28 SETUP**
Setup this remote control ([p. 116](#)).
- 29 ZONE**
Switches the zone to be operated by the remote control between the Main zone, Zone2, Zone3 and Zone4 ([p. 135](#)).

■ Installing batteries in the remote control

When inserting batteries in the remote control, remove the battery compartment cover from the reverse side of the remote control, and insert four AAA batteries into the battery compartment so that they match with the polarity markings (+ and -).

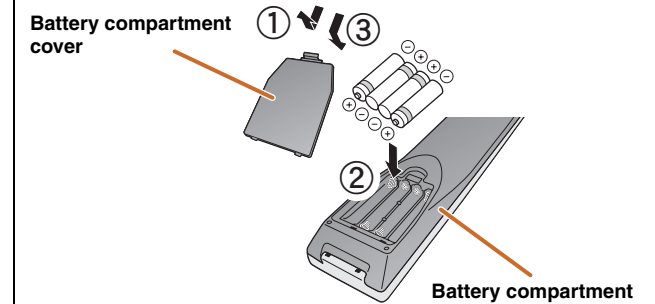

Replace the batteries with new ones if the remote control can only be operated within a narrow range.

NOTE

If there are remote control codes for external components registered to the remote control, removing the batteries for more than 2 minutes, or leaving exhausted batteries in the remote control, may clear the remote control codes. If this should occur, replace the batteries with new ones, and set the remote control codes.

On-screen display

When a TV is connected to this unit, the supplied remote control can be used to specify and verify this unit's settings via menus and options displayed on the TV screen.

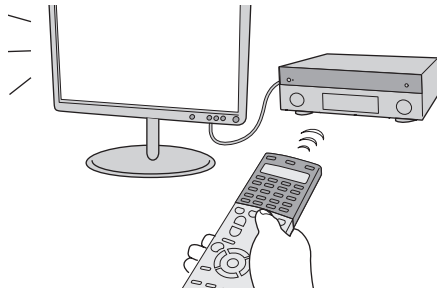

The following displays are available in the on-screen display.

ON SCREEN menu

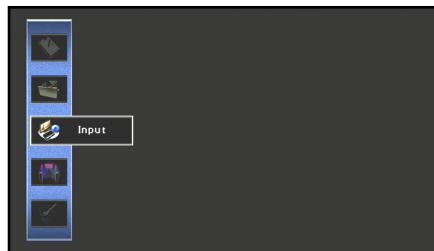

Press **[8] ON SCREEN** to display the ON SCREEN menu.

Detailed settings for this unit can be configured. Use this menu to select desired settings, change their values, or check the current status of this unit.

Refer to "SETUP" ([p. 84](#)) for details.

Option menu

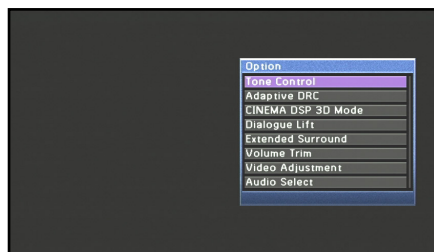

Press **[16] OPTION** to display the Option menu.

Configure the optional settings for each input source. Settings such as "Tone Control" and "Volume Trim" are applied to this unit regardless of the input source.

Refer to "Configuring settings specific to an individual input source (Option menu)" ([p. 61](#)) for details.

Content window



Press **[4] Input selector** to display the content window.

Includes the Browse view and the Now Playing view. The Now Playing view displays the status of the source from which music is currently played back. Adjust settings for music content from the Browse view.

Refer to "Confirming and operating input sources from the content window" ([p. 65](#)) for details.

CONNECTIONS

Connecting speakers

This unit uses acoustic field effects and sound decoders to bring you the impact of a real movie theater or concert hall. These effects will be brought to you with ideal speaker positioning and connections in your listening environment.

Speaker channels and functions

Front left and right speakers

The front speakers are used for the front channel sounds (stereo sound) and effect sounds.

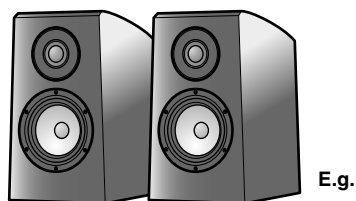

Front speaker layout:

Place these speakers at an equal distance from the ideal listening position in the front of the room. When using a projector screen, the appropriate top positions of the speakers are about 1/4 of the screen from the bottom.

Center speaker

The center speaker is for the center channel sounds (dialog, vocals, etc.).

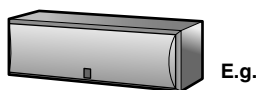

Center speaker layout:

Place it halfway between the left and right front speakers. When using a TV, place the speaker just above or just under the center of the TV with the front surfaces of the TV and the speaker aligned. When using a screen, place it just under the center of the screen.

Surround left and right speakers

The surround speakers are for effect and vocal sounds while playing back more than 5.1-channel source. When used with no surround back speaker while playing back more than 6.1-channel source (including surround back channel), sound of surround back channel is distributed between the left and right surround speakers.

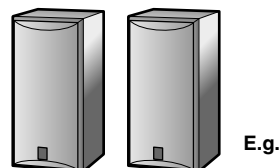

Surround speaker layout:

Place the speakers at the rear of the room on the left and right sides facing the listening position. They should be placed between 60 degrees and 80 degrees from the listening position and with the speaker tops at a height of 1.5 – 1.8 m from the floor.

Presence left and right speakers

The front and rear presence speakers are used for front and rear effect sounds. When used in combination with the sound programs ([p. 57](#)), a sound with a richer and more spatial presence is possible.

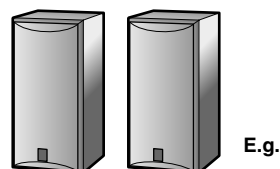

Presence speaker layout:

Place the left and right front presence speakers 0.5 – 1 m to the outside of the left and right front speakers respectively. The tops of the both front and rear presence speakers should be 1.8 m above the floor.

Surround back left and right speakers

The surround back speakers are for rear effect sounds while playing back more than 6.1-channel source. When used with only one surround back speaker while playing back more than 7.1-channel source, sound of the left and right surround back channel is mixed and output from a single speaker.

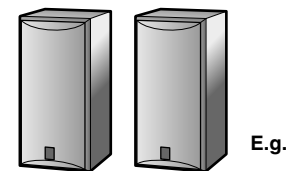

Surround back speaker layout:

When used with 7.1ch sound, arrange the left and right speakers towards the listening position, to the rear of the listening position. Arrange the left and right speakers at least 30 cm apart. The same separation as with the front left and right speakers is optimum. When used with 6.1ch sound, arrange these to the rear of the listening position.

Subwoofer

The subwoofer speaker is used for bass sounds and low-frequency effect (LFE) sounds included in Dolby Digital and DTS. Use a subwoofer that is equipped with built-in amplifier.



Subwoofer speaker layout:

Place it to the outside of the front left and right speakers facing slightly inward to reduce echoes from the wall. You can use one or two subwoofers and select the position of subwoofers from “Left + Right,” “Front + Rear” and “Monaural x2” ([p. 98](#)).



Speaker layout

In addition to the 7.1-channel speaker layout, a variety of speaker configurations can be specified with presence speaker connection, bi-amp connection or the Zone2/Zone3 function.

In addition, this unit is equipped with the “Power Amp Assign” function, which can be used to easily apply the appropriate speaker settings to this unit according to speaker configuration.

Connection of speakers

Connect the speakers to the appropriate jacks shown in the table for each speaker layout. Refer to “Connecting speakers and subwoofers” (p. 20) for details on connecting speakers.

You can also use two subwoofers by connecting them to both SUBWOOFER1 (FRONT) and SUBWOOFER2 (REAR) jacks. And, you can use the EXTRA SP1 jacks for Zone3 speakers and EXTRA SP2 jacks for Zone2 by setting the assignment with “Power Amp Assign” (p. 97).

Assigning a speaker configuration

A speaker configuration must be assigned to this unit to activate the speakers. Use the Power Amp Assign function to apply the appropriate settings shown in the table for each speaker layout. Refer to “Power Amp Assign” (p. 97) for details on setting.

Enjoying the 7.1 channel audio source

7.1-channel speaker layout (7 speakers + subwoofer)

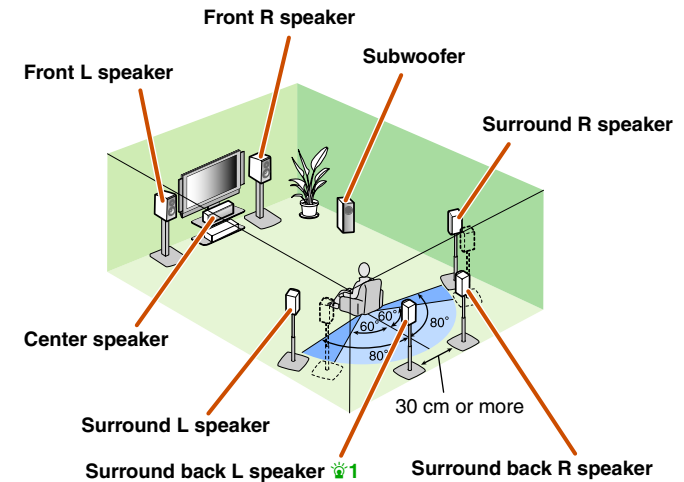

Audio from a 7.1-channel audio source can be played back with no degradation with this speaker configuration.

Connections of speakers

| | | | |
|-----------------------|-----------------------|---------------------------------|----------------------------|
| FRONT jacks | Front L/R speakers | SURROUND BACK jacks | Surround back L/R speakers |
| CENTER jack | Center speaker | SUBWOOFER (PRE OUT) jack | Subwoofer |
| SURROUND jacks | Surround L/R speakers | | |

Assigning a speaker configuration

| | |
|-------------------------|----------------------|
| Power Amp Assign | 7ch Normal (Default) |
|-------------------------|----------------------|

1: The sound of surround back channel can also be output from a single surround back speaker. When only one surround back speaker is used, connect it to the SURROUND BACK L (SINGLE) jack and place it directly behind the listening position.

■ Adding the front presence speakers for a richer sound field effect

■ Presence speaker layout (7 speakers + subwoofer + front presence speakers)

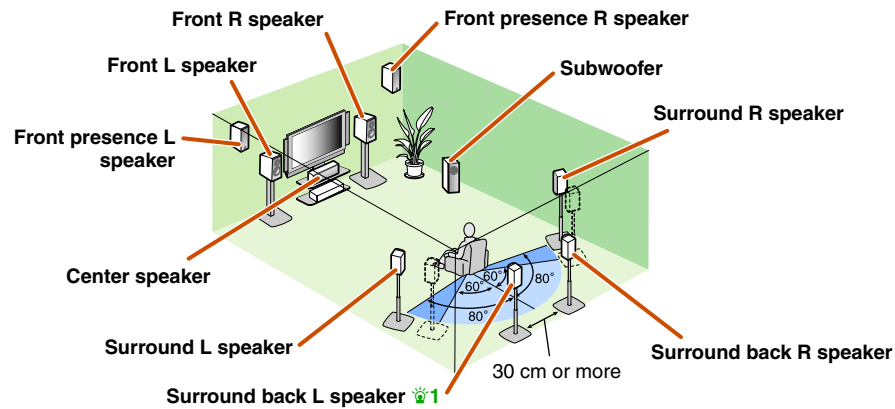

■ Enjoying the audio source without surround back speakers

■ 5.1-channel speaker layout (5 speakers + subwoofer)

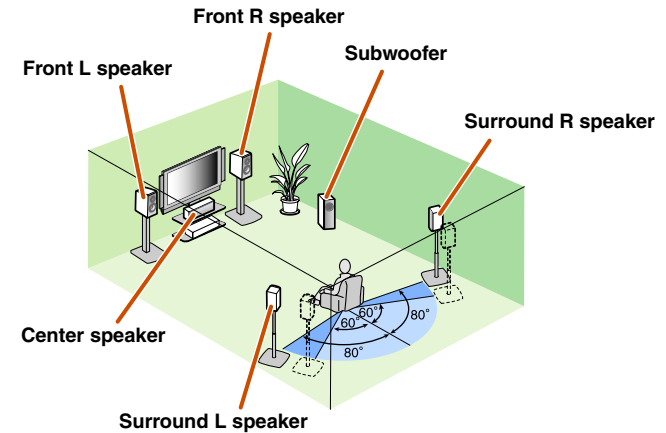

This unit automatically selects the front presence or surround back speakers to output sounds according to the selected sound program.
When the sound program is changed, the speakers that output the sound are switched between the front presence speakers and surround back speakers automatically. 🌟2

This unit can mix 7.1-channel audio source down to 5.1-channel sound. This enables 7.1-channel sound without surround back speakers.

■ Connections of speakers

| | | | |
|-----------------------|-----------------------|---------------------------------|-----------------------------|
| FRONT jacks | Front L/R speakers | SURROUND BACK jacks | Surround back L/R speakers |
| CENTER jack | Center speaker | SUBWOOFER (PRE OUT) jack | Subwoofer |
| SURROUND jacks | Surround L/R speakers | EXTRA SP1 jacks | Front presence L/R speakers |

■ Connections of speakers

| | | | |
|--------------------|--------------------|---------------------------------|-----------------------|
| FRONT jacks | Front L/R speakers | SURROUND jacks | Surround L/R speakers |
| CENTER jack | Center speaker | SUBWOOFER (PRE OUT) jack | Subwoofer |

■ Assigning a speaker configuration

| | |
|-------------------------|----------------------|
| Power Amp Assign | 7ch Normal (Default) |
|-------------------------|----------------------|

■ Assigning a speaker configuration

| | |
|-------------------------|----------------------|
| Power Amp Assign | 7ch Normal (Default) |
|-------------------------|----------------------|

🌟 1 : The sound of surround back channel can also be output from a single surround back speaker. When only one surround back speaker is used, connect it to the SURROUND BACK L (SINGLE) jack and place it directly behind the listening position.

🌟 2 : Sound cannot be output from the surround back speakers when it is output from the speakers connected to the EXTRA SP1 jacks.

Using the front speakers that support bi-amp connections for a high quality sound

5.1-channel speaker layout (Front speakers (Bi-amp) + 3 speakers)

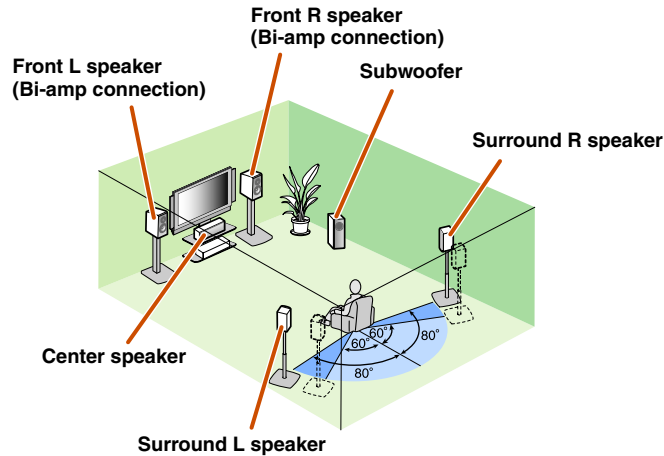

Using the front speakers that support bi-amp connections reproduces a high quality sound.

Connections of speakers

| | | | |
|-----------------------|-----------------------------|---------------------------------|-----------------------------|
| FRONT jacks | Front L/R speakers (bi-amp) | SURROUND BACK jacks | Front L/R speakers (bi-amp) |
| CENTER jack | Center speaker | SUBWOOFER (PRE OUT) jack | Subwoofer |
| SURROUND jacks | Surround L/R speakers | | |

Assigning a speaker configuration

| | |
|-------------------------|------------|
| Power Amp Assign | 5ch BI-AMP |
|-------------------------|------------|

1: The sound of surround back channel can also be output from a single surround back speaker. When only one surround back speaker is used, connect it to the SURROUND BACK L (SINGLE) jack and place it directly behind the listening position.

2: Sound cannot be output from the surround back speakers when it is output from the speakers connected to the EXTRA SP1 jacks.

3: EXTRA SP1 jacks can also be assigned to the Zone3 speakers with "Power Amp Assign" (p. 97).

Using speakers in two rooms (Zone2 function)

7.1-channel speaker layout + Zone2

(7 speakers (in main zone) + subwoofer (in main zone) + front speakers (in secondary zone))

Main zone

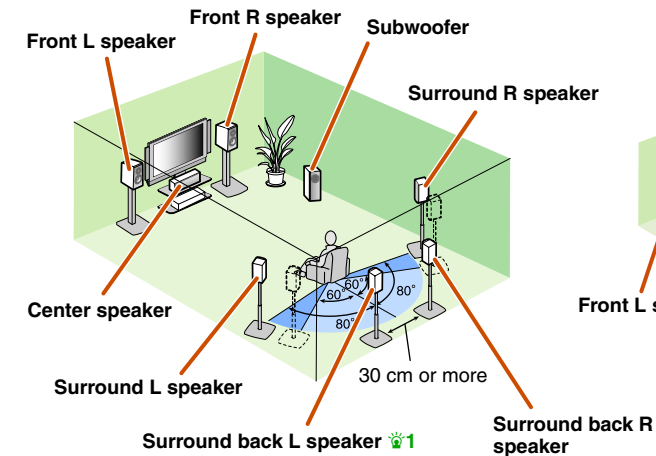

Zone2

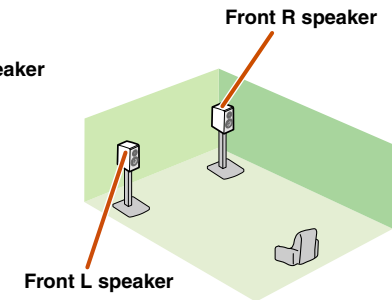

In addition to the main room, speakers in another room can also be controlled. When the built-in amplifier assigned to speakers in another room is turned on, sound output automatically switches from the surround back speakers to the speakers in the other room. **2**

Connections of speakers

| | | | |
|-----------------------|-----------------------|---------------------------------|----------------------------|
| FRONT jacks | Front L/R speakers | SURROUND BACK jacks | Surround back L/R speakers |
| CENTER jack | Center speaker | SUBWOOFER (PRE OUT) jack | Subwoofer |
| SURROUND jacks | Surround L/R speakers | EXTRA SP1 jacks 3 | Zone2 speakers |

Assigning a speaker configuration

| | |
|-------------------------|-------------|
| Power Amp Assign | 7ch + 1ZONE |
|-------------------------|-------------|

Using speakers in three rooms (Zone2 and Zone3 functions)

7.1-channel speaker layout + Zone2 + Zone3 (7 speakers (in main zone) + subwoofer (in main zone) + front speakers (in secondary and tertiary zones))

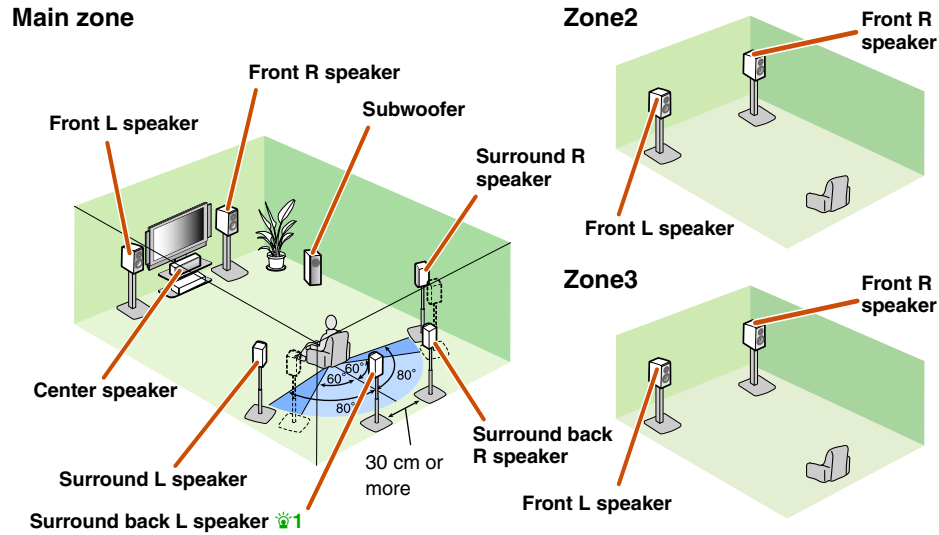

Connections of speakers

| | | | |
|---------------------|----------------------------|--------------------------|----------------|
| FRONT jacks | Front L/R speakers | SUBWOOFER (PRE OUT) jack | Subwoofer |
| CENTER jack | Center speaker | EXTRA SP1 jacks | Zone2 speakers |
| SURROUND jacks | Surround L/R speakers | EXTRA SP2 jacks | Zone3 speakers |
| SURROUND BACK jacks | Surround back L/R speakers | | |

Assigning a speaker configuration

| | |
|------------------|-------------|
| Power Amp Assign | 7ch + 2ZONE |
|------------------|-------------|

In addition to the main room, speakers in other two rooms can also be controlled. When the built-in amplifier assigned to speakers in another room is turned on, sound output automatically switches from the surround back and/or surround speakers to the speakers in the other rooms. ,

- 1: The sound of surround back channel can also be output from a single surround back speaker. When only one surround back speaker is used, connect it to the SURROUND BACK L (SINGLE) jack and place it directly behind the listening position.
- 2: Sound cannot be output from the surround back speakers when it is output from the speakers connected to the EXTRA SP1 jacks.
- 3: Sound cannot be output from the surround speakers when it is output from the speakers connected to the EXTRA SP2 jacks.

- 4: EXTRA SP1 jacks can also be assigned to the Zone3 speakers with "Power Amp Assign" ([p. 97](#)).
- 5: EXTRA SP2 jacks can also be assigned to the Zone2 speakers with "Power Amp Assign" ([p. 97](#)).

Connecting speakers and subwoofers

Connect your speakers to their respective terminals on the rear panel.

CAUTION

- Remove the power cable of this unit from the power outlet before connecting the speakers.
- Generally speaker cables consist of two parallel insulated cables. One of these cables is a different color, or has a line running along it, to indicate different polarity. Insert the different colored (or lined) cable into the “+” (positive, red) terminal on this unit and the speakers, and the other cable into the “-” (negative, black) terminal.
- Be careful that the core of the speaker cable does not touch anything or come into contact with the metal areas of this unit. This may damage this unit or the speakers. If the speaker cables short circuit, “CHECK SP WIRES!” will appear on the front panel display when this unit is switched on.

■ Front/Center/Surround/Surround back speaker and Subwoofer connection

When connecting only one surround back speaker, connect the speaker to the SURROUND BACK L (SINGLE) jacks.

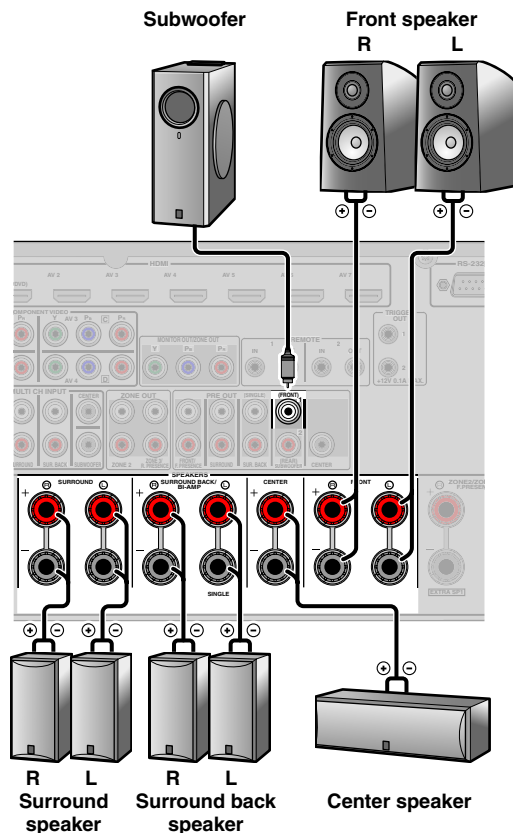

■ Front/rear presence speaker connection

When using the front presence speakers, connect the front presence speakers to EXTRA SP1 jacks. When using the rear presence speakers, connect the rear presence speakers to EXTRA SP2 jacks.

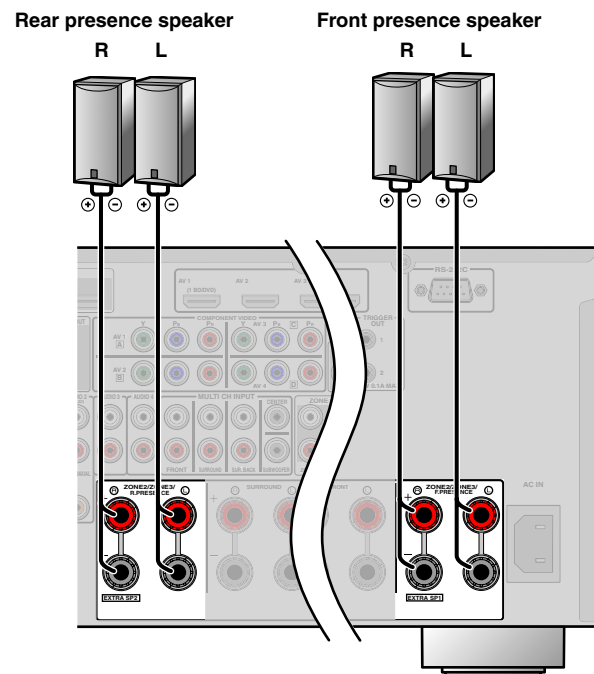

The presence speakers supplement the sound from the front and surround back speakers with extra ambient effects produced by the sound field programs ([p. 57](#)). You can adjust the vertical position of dialogues with using the front presence speakers ([p. 61](#)).

Front presence speakers

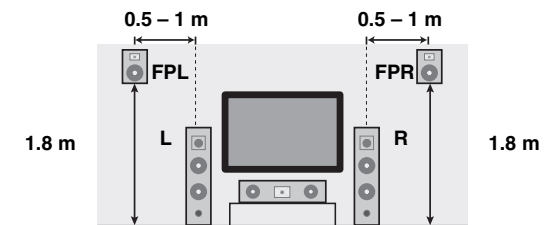

Rear presence speakers

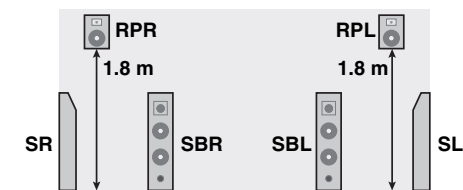

- Connection of presence speakers is recommended to take full advantage of the effects of CINEMA DSP sound programs.
- Place the rear presence left and right speakers so that the distance between the rear presence left and right speakers is same as the distance between front presence left and right speakers.

■ Bi-amp connection

This unit can be connected to speakers that support bi-amp connections. When connecting speakers, connect the FRONT jacks and the SURROUND BACK/BI-AMP jacks as in the diagram below. Configure the bi-amp settings to activate connections.

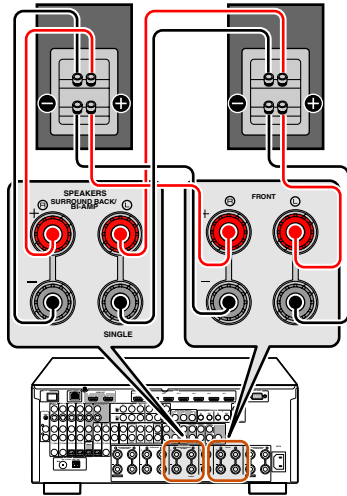

NOTE

Before making bi-amplification connections, remove any brackets or cables that connect a woofer with a tweeter. Refer to the instruction manuals of speakers for details. When not making bi-amplification connections, make sure that the brackets or cables are connected before connecting the speaker cables.

■ Multi-zone audio system using the internal amplifier of this unit

Connect the speakers in the second zone and the third zone to the EXTRA SP1/EXTRA SP2 jacks as in the diagram below.

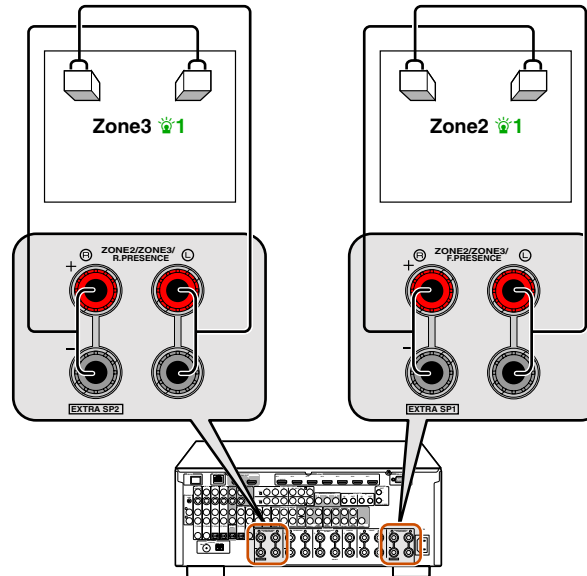

CAUTION

The EXTRA SP jacks of this unit should not be connected to a Passive Loudspeaker Selector Box or more than one loudspeaker per channel. Connection to a Passive Loudspeaker Selector Box or multiple speakers per channel could create an abnormally low impedance load resulting in amplifier damage. See this owner's manual for correct usage. Compliance with minimum speaker impedance information for all channels must be maintained at all times. This information is found on the back panel of this unit.

■ Changing speaker impedance

This unit is configured for 8 Ω speakers at factory setting. When connecting to 6 Ω speakers, carry out the following procedure to switch to 6 Ω. When this unit is configured for 6 Ω speakers, 4 Ω speakers can also be used as the front speakers.

- 1 Switch this unit to the standby mode.
- 2 Press **MAIN ZONE** while pressing and holding **STRAIGHT** on the front panel. Release the keys when "ADVANCED SETUP" is displayed on the front panel display. After approximately a few seconds, the top menu item is displayed.

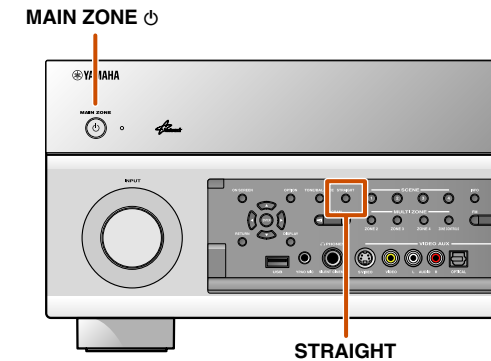

Continues to the next page

🔦 1 : EXTRA SP1 jacks can be assigned to Zone3 and EXTRA SP2 jacks can be assigned to Zone2 by using "Power Amp Assign" (p. 97).
 🔦 2 : Refer to the "Extended functionality that can be configured as needed (Advanced Setup menu)" (p. 125) for details on the Advanced Setup menu.

- Check that “SPEAKER IMP.” is displayed on the front panel.



- Press STRAIGHT repeatedly to select a “6ΩMIN.”

- Switch this unit to the standby mode, and then switch it on again.

The power turns on, when the settings you made has been configured.

Connecting speakers

This type of jack can connect to the following speakers or connection.

- Front L/R speakers
- Center speaker
- Surround L/R speakers
- Surround back L/R speakers
- Front presence L/R speakers
- Rear presence L/R speakers
- Zone2/Zone3 speakers
- Bi-amp connection (Front L/R speakers)

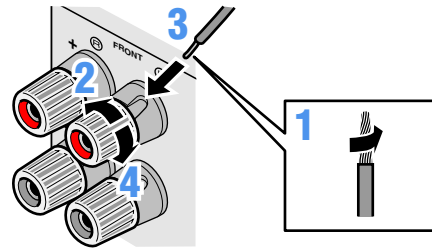

- Remove approximately 10 mm of insulation from the ends of the speaker cables, and twist the bare wires of the cables together firmly so that they will not cause short circuits.

- Loosen the speaker terminals.

- Insert the bare wire of the speaker cable into the gap on the side of the terminal.

- Tighten the terminal.

Connecting the subwoofers

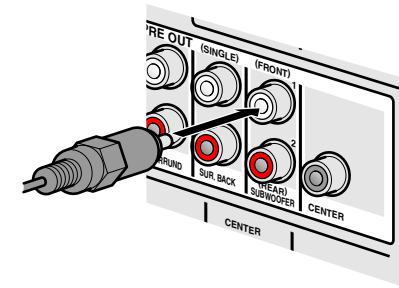

- Connect the subwoofer input jack to the SUBWOOFER 1 and/or 2 jack on this unit with an audio pin cable. 1

- Set the subwoofer volume as follows.
Volume: Set to approximately half volume (or slightly less than half).
Crossover frequency (if available): Set to maximum.

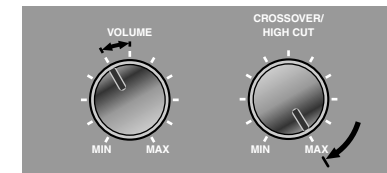

Subwoofer examples

NOTE

After connection, applying this setting to this unit is required to activate all speaker connections. With using “Power Amp Assign” function, you can easily apply the speaker configuration.

Refer to “Power Amp Assign” ([p. 97](#)) for details on using “Power Amp Assign” function.

1: When using the only one subwoofer, connect the subwoofer to the SUBWOOFER1 jack.

Advanced speaker configuration

Speaker layout utilizing an external power amplifier

More speakers can be used by connecting an external amplifier to this unit's PRE OUT jacks. The speaker layout specified using the Power Amp Assign function varies when an external amplifier is connected.

Symbols on the table

| | | | |
|------------|-------------------------|------------|--|
| L | Front L speaker | FPL | Front presence L speaker |
| C | Center speaker | FPR | Front presence R speaker |
| R | Front R speaker | RPL | Rear presence L speaker |
| SL | Surround L speaker | RPR | Rear presence R speaker |
| SR | Surround R speaker | | Speakers that output sound |
| SBL | Surround back L speaker | | Speakers that output sound depending upon settings |
| SBR | Surround back R speaker | EA | External amplifier |

Connections of speakers

Connect the speakers to the following jacks according to the speaker layout. Refer to “Front/Center/Surround/Surround back speaker and Subwoofer connection” and “Front/rear presence speaker connection” for details on connecting speakers ([p. 20](#)). Refer “Connecting an external amplifier” for details on connecting an external amplifier ([p. 27](#)).

Assigning a speaker configuration

A speaker configuration must be assigned to this unit to activate speakers and an external amplifier. Use the “Power Amp Assign” function to easily apply the appropriate speaker settings to this unit in accordance with speaker configuration.

1: Sound cannot be output from the surround back speakers when it is output from the speakers connected to the EXTRA SP2 jacks.

2: You can also use two subwoofers by connecting them to both SUBWOOFER1 (FRONT) and SUBWOOFER2 (REAR) jacks.

Improving sound quality of front speaker by more high quality Hi-Fi amplifier

9.1-channel speaker layout (7 speakers + subwoofer + external front speakers)

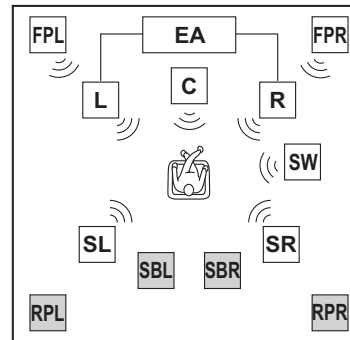

This unit automatically selects the rear presence speakers or surround back speakers to output sounds according to the selected sound program. **1**
The front speaker channel can be enhanced by using an external amplifier possible of greater output power than this unit.

Connections of speakers

| | |
|--|--|
| CENTER jack | Center speaker |
| SURROUND jacks | Surround L/R speakers |
| SURROUND BACK jacks | Surround back L/R speakers |
| FRONT (PRE OUT) jacks | External amplifier (for front L/R speakers) |
| SUBWOOFER (PRE OUT) jack 2 | Subwoofer |
| EXTRA SP1 jacks | Front presence L/R speakers |
| EXTRA SP2 jacks | Rear presence L/R speakers |

Assigning a speaker configuration

| | |
|-------------------------|-------------|
| Power Amp Assign | 7ch + FRONT |
|-------------------------|-------------|

Using an external amplifier to output the front presence speaker channel

9.1-channel speaker layout (7 speakers + subwoofer + external front presence speakers)

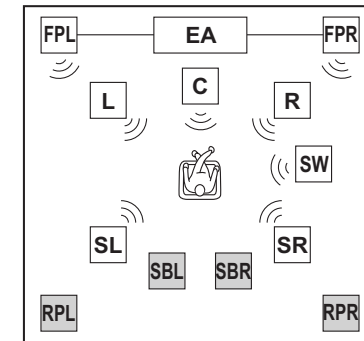

This unit automatically selects the rear presence speakers or surround back speakers to output sounds according to the selected sound program. **1**
The front presence and surround back speaker channels can be output at the same time.

Connections of speakers

| | |
|--|---|
| FRONT jacks | Front L/R speakers |
| CENTER jack | Center speaker |
| SURROUND jacks | Surround L/R speakers |
| SURROUND BACK jacks | Surround back L/R speakers |
| F.PRESENCE (PRE OUT) jacks | External amplifier (for front presence L/R speakers) |
| SUBWOOFER (PRE OUT) jack 2 | Subwoofer |
| EXTRA SP2 jacks | Rear presence L/R speakers |

Assigning a speaker configuration

| | |
|-------------------------|-----------|
| Power Amp Assign | 7ch + FPR |
|-------------------------|-----------|

Using the presence speakers in the main room and speakers in another room

9.1-channel speaker layout

(7 speakers + subwoofer + external front presence speakers + front speakers (in secondary zone))

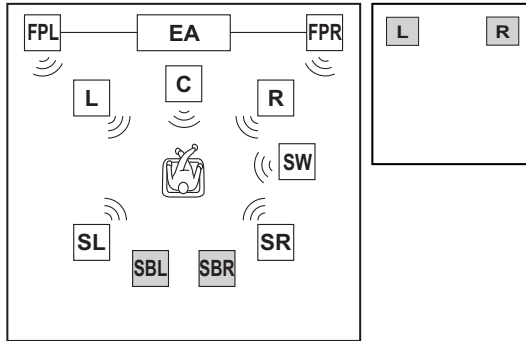

The presence speakers in the main room can be used while the front speakers in another room are used. 🌟1

Connections of speakers

| | |
|-----------------------------|---|
| FRONT jacks | Front L/R speakers |
| CENTER jack | Center speaker |
| SURROUND jacks | Surround L/R speakers |
| SURROUND BACK jacks | Surround back L/R speakers |
| EXTRA SP1 jacks 🌟2 | Zone2 speakers |
| F.PRESENCE (PRE OUT) jacks | External amplifier (for front presence L/R speakers) |
| SUBWOOFER (PRE OUT) jack 🌟3 | Subwoofer |

Assigning a speaker configuration

| | |
|------------------|-------------------|
| Power Amp Assign | 7ch + FPR + 1ZONE |
|------------------|-------------------|

Using the external amplifier to output the rear presence speaker channel

9.1-channel speaker layout

(7 speakers + subwoofer + external rear presence speakers)

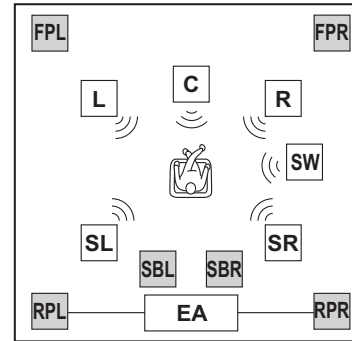

This unit automatically selects the front presence speakers or surround back speakers to output sounds according to the selected sound program. 🌟1
The rear presence speaker channel cannot be output when the front presence speaker channel is not output. 🌟4

Connections of speakers

| | |
|-----------------------------|--|
| FRONT jacks | Front L/R speakers |
| CENTER jack | Center speaker |
| SURROUND jacks | Surround L/R speakers |
| SURROUND BACK jacks | Surround back L/R speakers |
| SUBWOOFER (PRE OUT) jack 🌟3 | Subwoofer |
| R.PRESENCE (ZONE OUT) jacks | External amplifier (for rear presence L/R speakers) |
| EXTRA SP1 jacks | Front presence L/R speakers |

Assigning a speaker configuration

| | |
|------------------|-----------|
| Power Amp Assign | 7ch + RPR |
|------------------|-----------|

Using the external amplifier to output the front and rear presence speaker channels

11.1-channel speaker layout

(7 speakers + subwoofer + front and rear presence speakers)

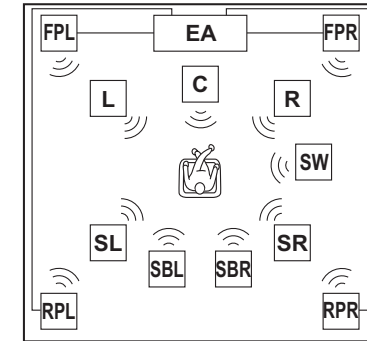

The front and rear presence, surround back and surround speakers can be output at the same time. 🌟4

Connections of speakers

| | |
|-----------------------------|---|
| FRONT jacks | Front L/R speakers |
| CENTER jack | Center speaker |
| SURROUND jacks | Surround L/R speakers |
| SURROUND BACK jacks | Surround back L/R speakers |
| F.PRESENCE (PRE OUT) jacks | External amplifier (for front presence L/R speakers) |
| SUBWOOFER (PRE OUT) jack 🌟3 | Subwoofer |
| R.PRESENCE (ZONE OUT) jacks | External amplifier (for rear presence L/R speakers) |

Assigning a speaker configuration

| | |
|------------------|-----------------|
| Power Amp Assign | 7ch + FPR + RPR |
|------------------|-----------------|

🌟1 : Sound cannot be output from the surround back speakers when it is output from the speakers connected to the EXTRA SP1 jacks.

🌟2 : EXTRA SP1 jacks can also be assigned to the Zone3 speakers with "Power Amp Assign" (see p. 97).

🌟3 : You can also use two subwoofers by connecting them to both SUBWOOFER1 (FRONT) and SUBWOOFER2 (REAR) jacks.

🌟4 : The sound cannot be output for Zone3 in this condition.

Using the external amplifier to output the front and rear presence speaker channels in main room and front speakers in another room

- 11.1-channel speaker layout (7 speakers + subwoofer + external front and rear presence speakers + front speakers (in secondary zone))

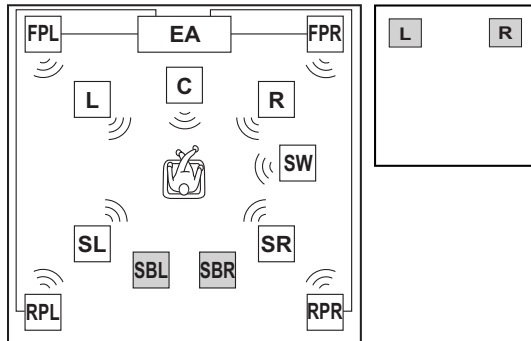

The presence speakers can be used for main room while the front speakers are used for another room. 🌟1 🌟2

Connections of speakers

| | |
|-----------------------------|--|
| FRONT jacks | Front L/R speakers |
| CENTER jack | Center speaker |
| SURROUND jacks | Surround L/R speakers |
| SURROUND BACK jacks | Surround back L/R speakers |
| F.PRESENCE (PRE OUT) jacks | External amplifier (for front presence L/R speakers) |
| SUBWOOFER (PRE OUT) jack 🌟3 | Subwoofer |
| R.PRESENCE (ZONE OUT) jacks | External amplifier (for rear presence L/R speakers) |
| EXTRA SP1 jacks 🌟4 | Zone2 speakers |

Assigning a speaker configuration

| | |
|------------------|-------------------------|
| Power Amp Assign | 7ch + FPR + RPR + 1ZONE |
|------------------|-------------------------|

- 🌟1: Sound cannot be output from the surround back speakers when it is output from the speakers connected to the EXTRA SP1 jacks.
- 🌟2: The sound cannot be output for Zone3 in this condition.
- 🌟3: You can also use two subwoofers by connecting them to both SUBWOOFER1 (FRONT) and SUBWOOFER2 (REAR) jacks.

Using front speakers that support bi-amp connection and front presence speakers

- 7.1-channel speaker layout (Front speaker (Bi-amp) + 3 speakers + subwoofer + external front presence speakers)

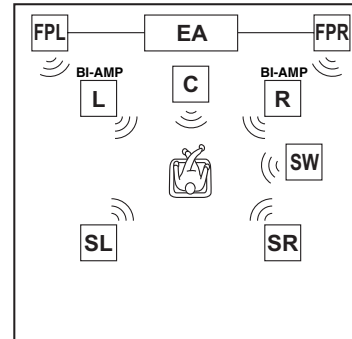

A richer sound field can be created with the simultaneous use of front speakers that support bi-amp connection and front presence speakers.

Connections of speakers

| | |
|-----------------------------|--|
| FRONT jacks | Front L/R speakers (bi-amp) |
| CENTER jack | Center speaker |
| SURROUND jacks | Surround L/R speakers |
| SURROUND BACK jacks | Front L/R speakers (bi-amp) |
| F.PRESENCE (PRE OUT) jacks | External amplifier (for front presence L/R speakers) |
| SUBWOOFER (PRE OUT) jack 🌟3 | Subwoofer |

Assigning a speaker configuration

| | |
|------------------|------------------|
| Power Amp Assign | 5ch BI-AMP + FPR |
|------------------|------------------|

- 🌟4: EXTRA SP1 jacks can also be assigned to Zone3 speakers with "Power Amp Assign" (p. 97).

Using front speakers that support bi-amp connection and surround back speakers

- 7.1-channel speaker layout (Front speaker (Bi-amp) + 3 speakers + subwoofer + external surround back speakers)

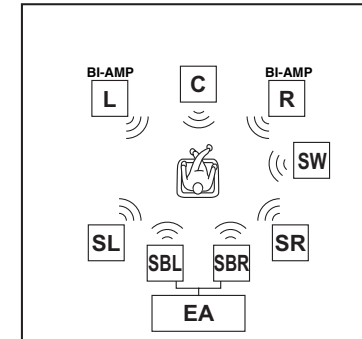

Connecting surround back speakers to an external amplifier enables simultaneous use of front speakers that support bi-amp connection and surround back speakers.

Connections of speakers

| | |
|-----------------------------|---|
| FRONT jacks | Front L/R speakers (bi-amp) |
| CENTER jack | Center speaker |
| SURROUND jacks | Surround L/R speakers |
| SURROUND BACK jacks | Front L/R speakers (bi-amp) |
| SUR.BACK (PRE OUT) jacks | External amplifier (for surround back L/R speakers) |
| SUBWOOFER (PRE OUT) jack 🌟3 | Subwoofer |

Assigning a speaker configuration

| | |
|------------------|-----------------|
| Power Amp Assign | 5ch BI-AMP + SB |
|------------------|-----------------|

Using front speakers that support bi-amp connection, surround back speakers and front presence speakers

9.1-channel speaker layout

(Front speaker (Bi-amp) + 3 speakers + subwoofer + external surround back speakers + external front presence speakers)

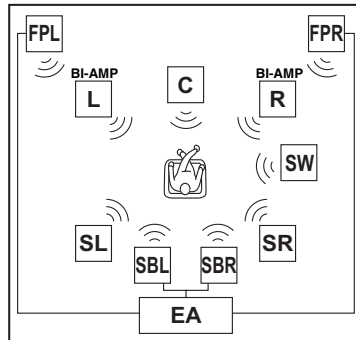

When an external amplifier is used, front presence speakers and surround back speakers can be used simultaneously with front speakers that support bi-amp connection. 🌟1

Connections of speakers

| | |
|-----------------------------|--|
| FRONT jacks | Front L/R speakers (bi-amp) |
| CENTER jack | Center speaker |
| SURROUND jacks | Surround L/R speakers |
| SURROUND BACK jacks | Front L/R speakers (bi-amp) |
| F.PRESENCE (PRE OUT) jacks | External amplifier (for surround back L/R speakers) |
| SUBWOOFER (PRE OUT) jack 🌟2 | Subwoofer |

Assigning a speaker configuration

| | |
|------------------|-----------------------|
| Power Amp Assign | 5ch BI-AMP + SB + FPR |
|------------------|-----------------------|

Using the front speakers that support bi-amp connections, the external amplifier to output the front and rear presence channels

9.1-channel speaker layout

(Front speaker (Bi-amp) + 3 speakers + subwoofer + external front and rear presence speakers)

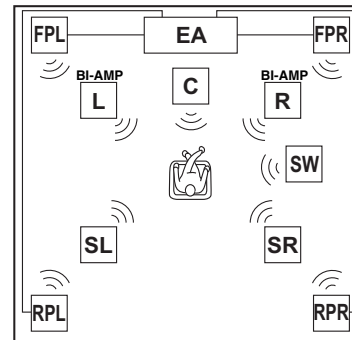

Using the external amplifier can enable to use the front and rear presence speakers while using the front speakers that support bi-amp connections. 🌟1 🌟3

Connections of speakers

| | |
|-----------------------------|---|
| FRONT jacks | Front L/R speakers (bi-amp) |
| CENTER jack | Center speaker |
| SURROUND jacks | Surround L/R speakers |
| SURROUND BACK jacks | Front L/R speakers (bi-amp) |
| F.PRESENCE (PRE OUT) jacks | External amplifier (for front presence L/R speakers) |
| SUBWOOFER (PRE OUT) jack 🌟2 | Subwoofer |
| R.PRESENCE (ZONE OUT) jacks | External amplifier (for rear presence L/R speakers) |

Assigning a speaker configuration

| | |
|------------------|------------------------|
| Power Amp Assign | 5ch BI-AMP + FPR + RPR |
|------------------|------------------------|

🌟1: An external amplifier equipped with four channels is required for this speaker layout.

🌟2: You can also use two subwoofers by connecting them to both SUBWOOFER1 (FRONT) and SUBWOOFER2 (REAR) jacks.

🌟3: The sound cannot be output for Zone3 in this condition.

Connecting an external amplifier

The same channel signals are output from the jacks of the PRE OUT and ZONE OUT terminals as from their corresponding SPEAKERS terminals. When connecting an external power amplifier (pre-main amplifier) to enhance speaker output, connect the input terminals of the power amplifier to the PRE OUT and ZONE OUT terminals of this unit.

NOTES

- When a component is connected to the PRE OUT and ZONE OUT terminals, do not connect speakers to the SPEAKERS terminals corresponding to those PRE OUT and ZONE OUT terminals.
- When an external amplifier equipped with a volume adjustment function is connected, a sufficient volume level may not be achieved.

Use of the following components is recommended.

- An amplifier with no volume adjustment function.
- An integrated amplifier equipped with a function that bypasses volume circuitry, such as the Yamaha A-S2000 with MAIN IN input.

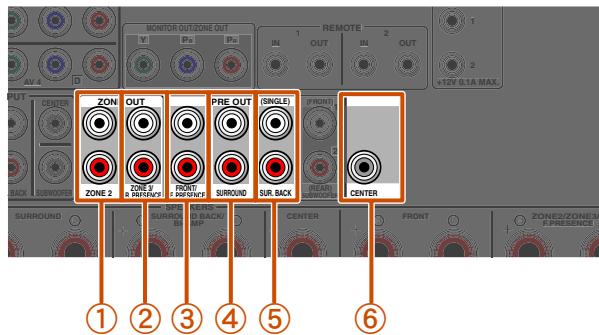

- ① **ZONE2 jacks**
Zone2 channel output jacks.
- ② **ZONE3/R.PRESENCE jacks**
Zone3 channel or rear presence channel output jacks.
- ③ **FRONT/F.PRESENCE (PRE OUT) jacks**
Front channel or front presence channel output jacks.
- ④ **SURROUND (PRE OUT) jacks**
Surround channel output jacks.
- ⑤ **SUR. BACK (PRE OUT) jacks**
Surround back output jacks. When you only connect one external amplifier for the surround back channel, connect it to the SUR. BACK (SINGLE) jack.
- ⑥ **CENTER (PRE OUT) jack**
Center channel output jack.

Connecting external components

Jacks and cables

This unit is equipped with the following input/output jacks. Use jacks and cables appropriate for components that you are going to connect.

Audio/Video jacks

HDMI jacks

Digital video and digital sound are transmitted through a single jack.
Only use an HDMI cable.

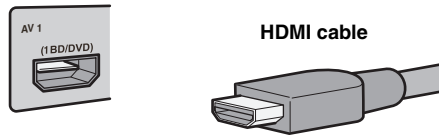

- Use a 19-pin HDMI cable with the HDMI logo.
- We recommend using a cable less than 5.0 m long to prevent signal quality degradation.
- When a TV that supports HDMI functions and Audio Return Channel function is connected, audio output from the TV can be input to this unit ([p. 131](#)).
- When a player and TV that support the 3D video format are connected to this unit, 3D content can be played back.
- If you connect this unit to a component that has a DVI jack, an HDMI/DVI-D cable is required.

Analog video jacks

COMPONENT VIDEO jacks

The signal is separated into three components: luminance (Y), chrominance blue (PB), and chrominance red (PR).
Use component video pin cables with three plugs.

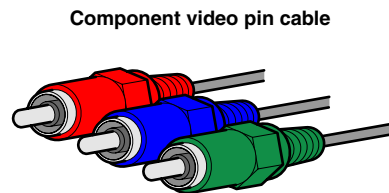
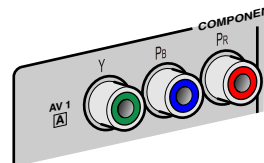

S-VIDEO jacks

To transmit S-video signals that include luminance (Y) and chrominance (C) components.
Use S-video cables.



S-video cable

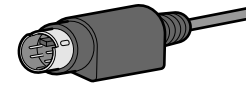

VIDEO jacks

These jacks transmit conventional analog video signals.
Use video pin cables.

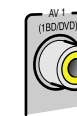

Video pin cable

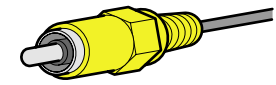

Audio jacks

OPTICAL jacks

These jacks transmit optical digital audio signals.
Use fiber-optic cables for optical digital audio signals.



Digital audio fiber-optic cable



COAXIAL jacks

These jacks transmit coaxial digital audio signals.
Use pin cables for digital audio signals.



Digital audio pin cable

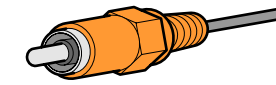

AUDIO jacks

These jacks transmit conventional analog audio signals.
Use stereo pin cables, connecting the red plug to the red R jack, and the white plug to the white L jack.



Stereo pin cable

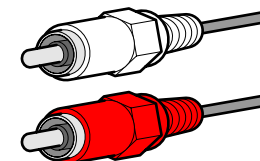

Connecting a TV monitor

This unit is equipped with the following four types of output jack for connection to a TV. HDMI OUT 1-2, COMPONENT VIDEO, S-VIDEO or VIDEO. Select the proper connection according to the input signal format supported by your TV.

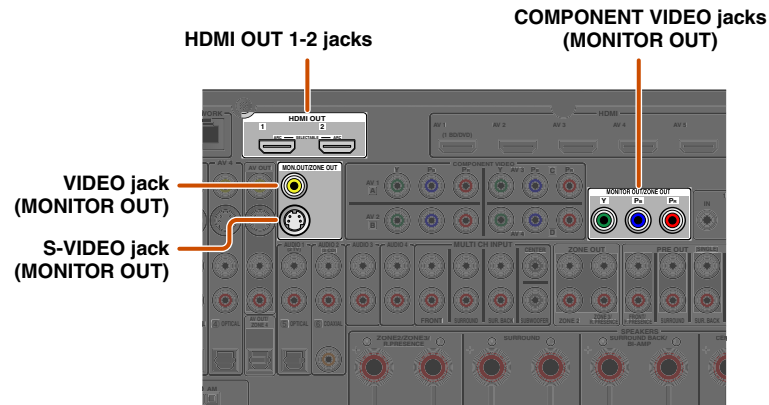

When connecting to an HDMI compatible TV

Video signal such as component video, S-video and video received by this unit is converted to HDMI and output to the TV. Just select HDMI input on the TV to view video from any external source connected to this unit. 🌟1

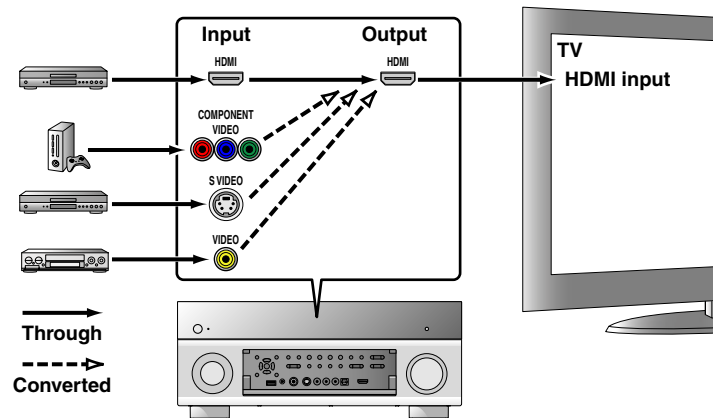

🌟 1 : You can change the resolution and aspect ratio when converting to HDMI to suit your requirements ([see p. 102](#)).

🌟 2 : Set "Analog to Analog Conversion" to "On" ([see p. 102](#)).

🌟 3 : Analog to analog conversion is available only for 480i/576i-resolution video signal.

When connecting to a non-HDMI compatible TV

Connect to the TV using the same type of connection that you used to connect to the external component, and change the inputs on your TV to match that of the external component you are using for playback. If the external component and TV are equipped with different types of analog video jacks, this unit will convert the component video, S-video or video signal to component video, S-video or video signal, according to the type of video input jacks used by the TV. 🌟2, 🌟3

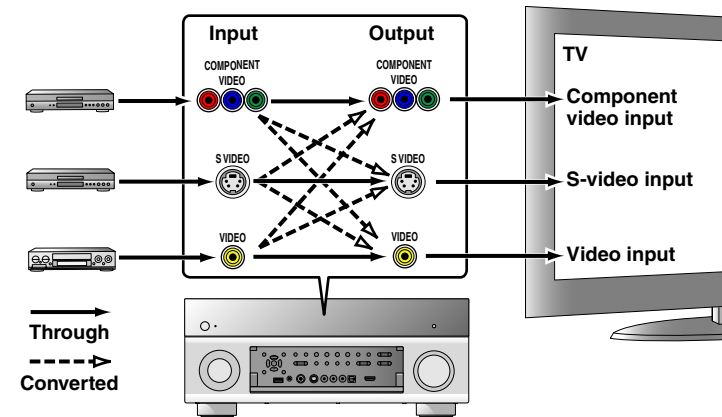

■ Connecting an HDMI video monitor

Connect the HDMI cable to one of the HDMI OUT 1-2 jacks.

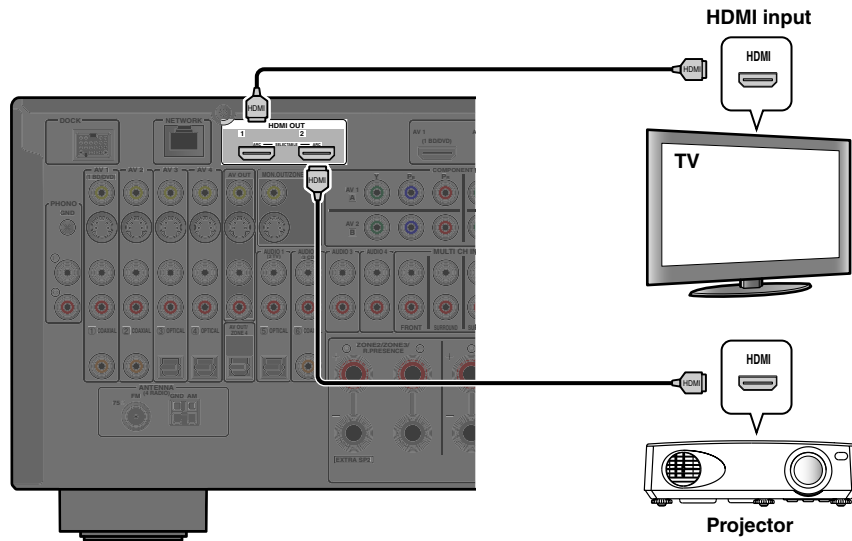

■ Connecting a component video monitor 🌟1

Connect the component video cable to the COMPONENT VIDEO (MONITOR OUT) jacks.

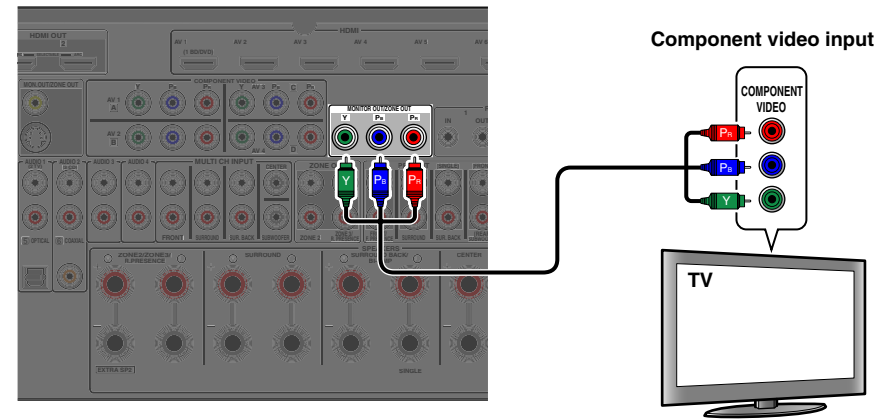

■ Connecting a S-video monitor 🌟1

Connect the S-video cable to the S-VIDEO (MONITOR OUT) jack.

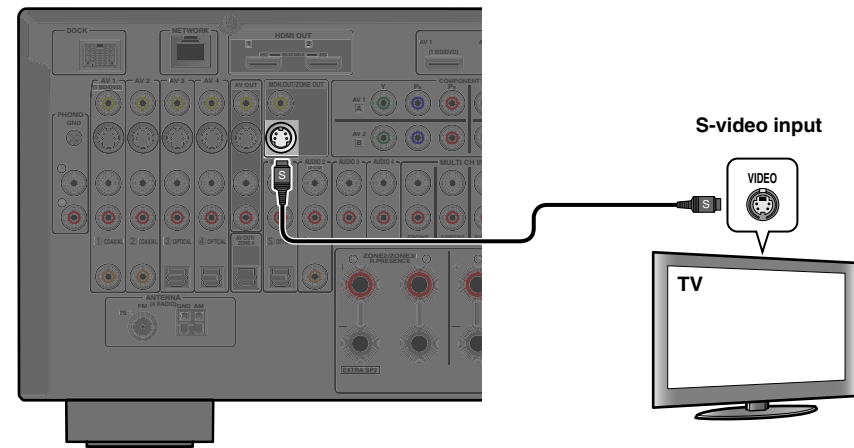

- Use a 19-pin HDMI cable with the HDMI logo.
- We recommend using a cable less than 5.0 m long to prevent signal quality degradation.
- When a TV that supports the HDMI function and Audio Return Channel function is connected, audio output from the TV can be input to this unit ([p. 131](#)).
- When a player and TV that support the 3D video format are connected to this unit, 3D content can be played back.
- This unit is equipped with HDMI OUT 1 and 2 jacks. The active HDMI OUT jack(s) can be selected ([p. 51](#)). The active HDMI OUT jack(s) can be registered with the SCENE function ([p. 87](#)).

🌟 1 : The video signal for the COMPONENT VIDEO or S-VIDEO jacks is converted and output from HDMI OUT 1-2 jacks. When connecting to a TV via the HDMI jack, you do not need to use these jacks.

■ Connecting a video monitor

Connect the video pin cable to the VIDEO (MONITOR OUT) jack.

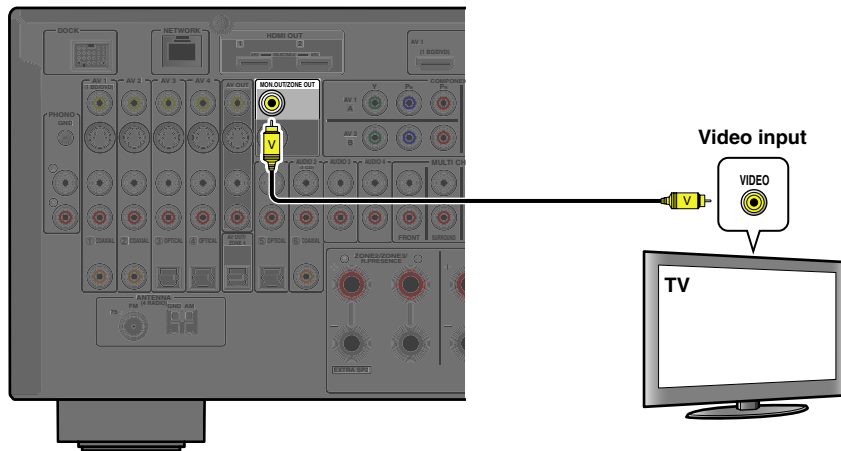

■ Listening to TV audio

To transmit sound from the TV to this unit, connect as followings according to the TV:

When using a TV that supports the Audio Return Channel function and HDMI Control function

When your TV supports both HDMI Control (e.g., Panasonic VIERA Link) and Audio Return Channel functions, audio/video output from the unit to the TV and audio output from the TV to the unit are possible using a single HDMI cable.

The input source is switched automatically to match operations carried out on the TV, and that makes TV sound control easier to use.

For the connections and settings, refer to “Single HDMI cable input to TV audio with Audio Return Channel function” ([p. 131](#)).

When using a TV that supports the HDMI Control functions

When using a TV that supports HDMI Control functions (e.g., Panasonic VIERA Link), if HDMI Control functions are enabled on the unit, then input source can be switched automatically to match operations carried out on the TV.

For the connections and settings, refer to “Switching the input source on this unit automatically when listening to TV audio” ([p. 130](#)).

When using other TVs

To transmit sound from the TV to this unit, connect the TV’s audio output to the AUDIO1-4 jacks.

| TV audio output | Connection |
|------------------------------|---|
| Optical digital audio output | Connect to the OPTICAL jack of the AUDIO1 with a fiber-optic cable. |
| Coaxial digital audio output | Connect to the COAXIAL jack of the AUDIO2 with a digital audio pin cable. |
| Analog stereo output | Connect to one of the AUDIO1-4 with a stereo pin cable. |

Select the input source connected via TV’s audio output jack to enjoy the TV sound.

If the TV supports optical digital audio output, we recommend that you connect the TV audio output to the receiver’s AUDIO1 jack.

Connecting to AUDIO1 allows you to switch the input source to AUDIO1 with just a single key operation using the SCENE function ([p. 53](#)).

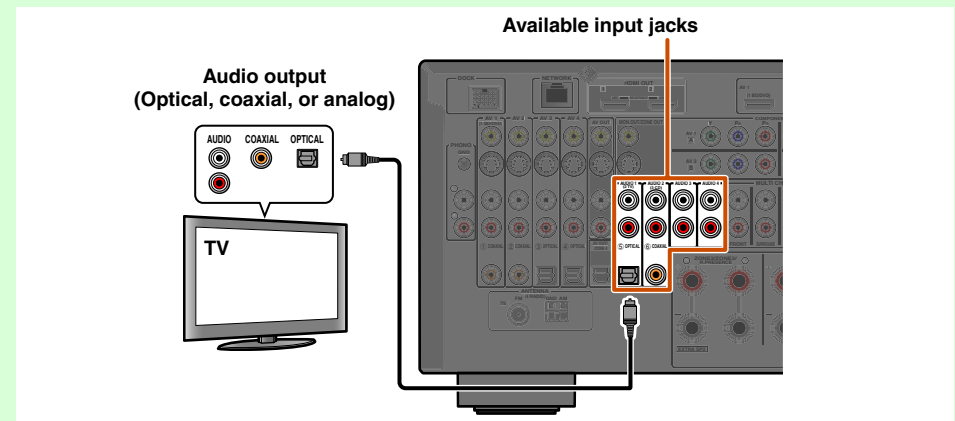

You can control your TV using the receiver’s remote control by entering the TV’s remote control code ([p. 117](#)).

 1 : The video signal for the VIDEO jacks is converted and output from HDMI OUT 1-2 jacks. When connecting to a TV via the HDMI jack, you do not need to use these jacks.

Connecting BD/DVD players and other devices

This unit has the following input jacks. Connect them to the appropriate output jacks on the playback devices such as BD/DVD players.

| Input jack | Video input | Audio input |
|------------|------------------------------------|--|
| AV1 🌟1 | HDMI/Component video/S-video/Video | HDMI/Coaxial digital/Analog (Stereo) |
| AV2 🌟1 | HDMI/Component video/S-video/Video | HDMI/Coaxial digital/Analog (Stereo) |
| AV3 🌟1 | HDMI/Component video/S-video/Video | HDMI/Optical digital/Analog (Stereo) |
| AV4 🌟1 | HDMI/Component video/S-video/Video | HDMI/Optical digital/Analog (Stereo) |
| AV5 | HDMI | HDMI |
| AV6 | HDMI | HDMI |
| AV7 | HDMI | HDMI |
| AUDIO1 | — | Optical digital/Analog (Stereo) |
| AUDIO2 | — | Coaxial digital/Analog (Stereo) |
| AUDIO3 | — | Analog (Stereo) |
| AUDIO4 | — | Analog (Stereo) |
| VIDEO AUX | HDMI/S-video/Video | HDMI/Optical digital/Analog (Stereo) |
| PHONO | — | Analog (Only for connecting a turntable) |

Connecting BD/DVD players and other devices with HDMI cable

Connect the device with an HDMI cable to one of the HDMI jacks of the AV1-7. The HDMI IN jack of the VIDEO AUX on the front panel can also be used. Select the input source (AV1-7 or V-AUX) that the playback device is connected to for playback.

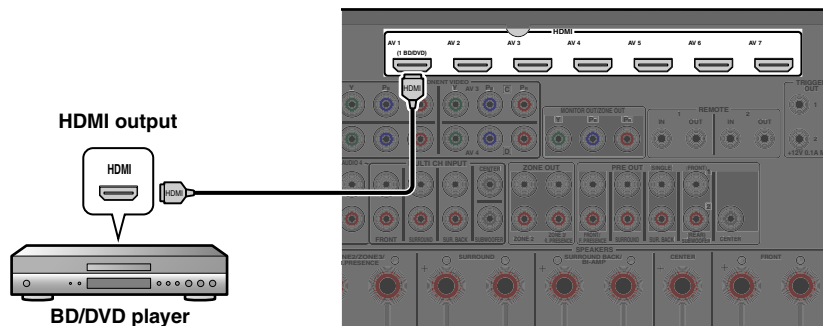

Receiving video signals from the HDMI jack and audio signals from jacks other than HDMI

This unit can use the AV1-4 or AUDIO1-4 input jacks to receive audio signals from other input jacks.

For example, if a playback device cannot produce audio signals from an HDMI jack, use the following method to change the audio input.

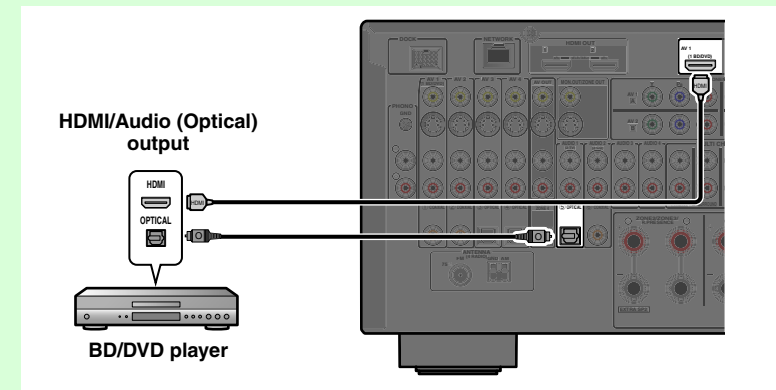

- Press **[4]** **Input selector** to choose an input source (AV1-4, V-AUX, AUDIO1-4, or PHONO).
- Press **[16]** **OPTION** to enter the Option menu.
- Press **[9]** **Cursor** Δ / ∇ to choose "Audio Select" and press **[9]** **ENTER**.
- Press **[9]** **Cursor** $\triangleleft / \triangleright$ to choose an audio input jack and press **[9]** **ENTER**.
- Once setup is complete, press **[16]** **OPTION** to close the Option menu.

🌟 1: Coaxial digital and optical digital jacks function can be assigned to other AV jacks using "Input Assignment." Refer to "Input Assignment" for details ([see p. 110](#)).

Connecting BD/DVD players and other devices with component video cables

Connect the device with a component video cable to one of the AV1-4 input jacks.

Using optical digital audio output sources

Connect the playback device to the AV3 or AV4 jacks.

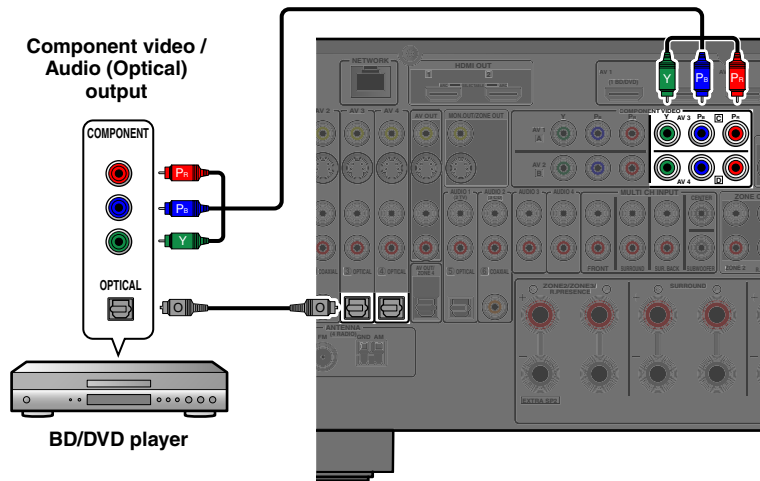

Using analog stereo audio output sources

Connect the playback device to the AV1, AV2, AV3 or AV4 jacks.

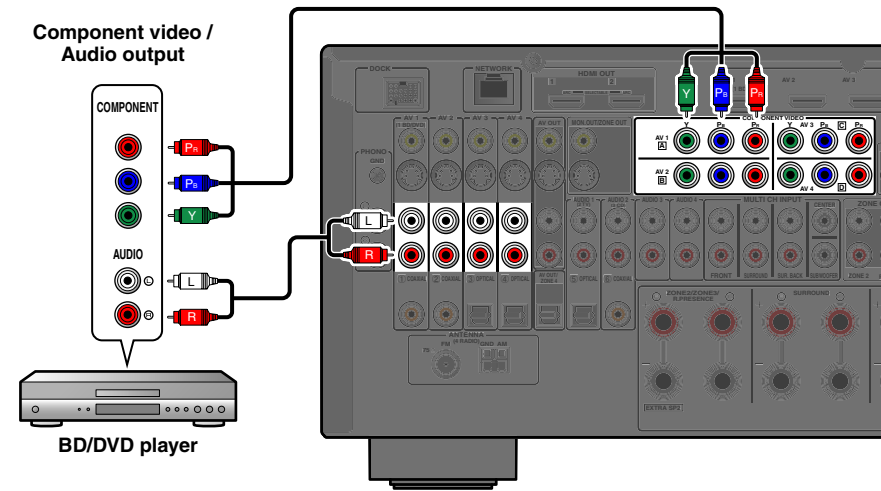

Using coaxial digital audio output sources

Connect the playback device to the AV1 or AV2 jacks.

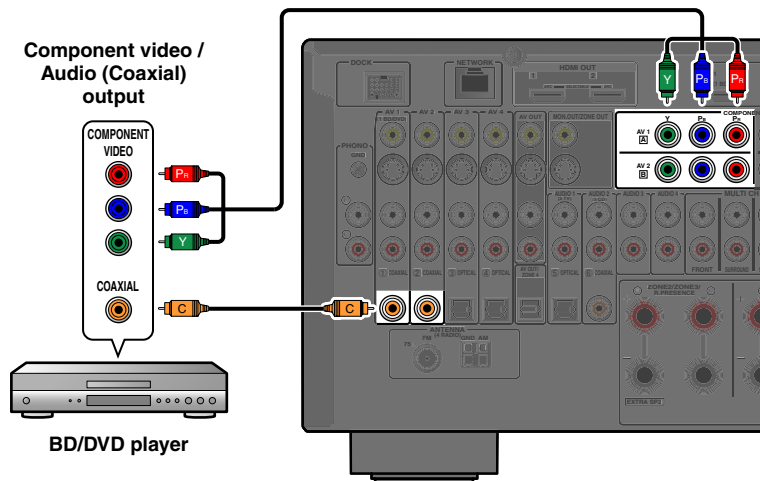

■ Connecting BD/DVD players and other devices with S-video cables

Connect the playback device with a S-video cable to one of the AV1-4 input jacks.

Using optical digital audio output sources

Connect the playback device to the AV3 or AV4 jacks.

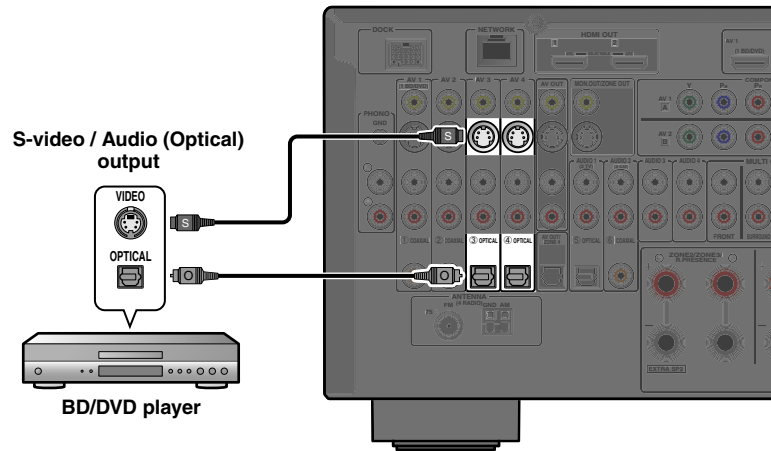

Using coaxial digital audio output sources

Connect the playback device to the AV1 or AV2 jacks.

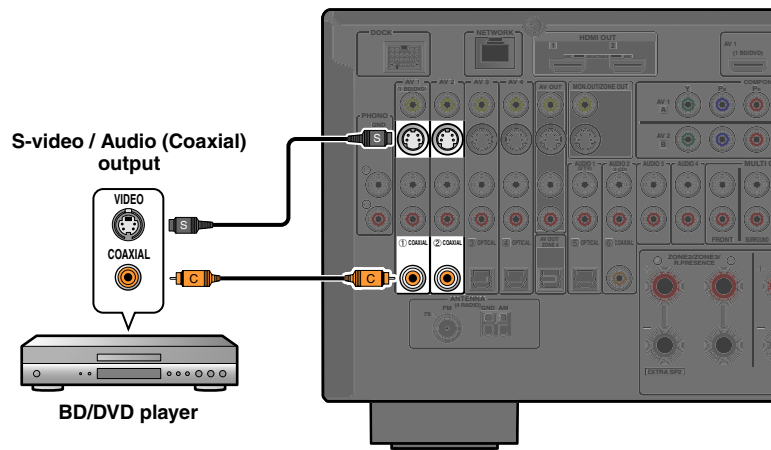

Using analog stereo audio output sources

Connect the playback device to the AV1, AV2, AV3 or AV4 jacks.

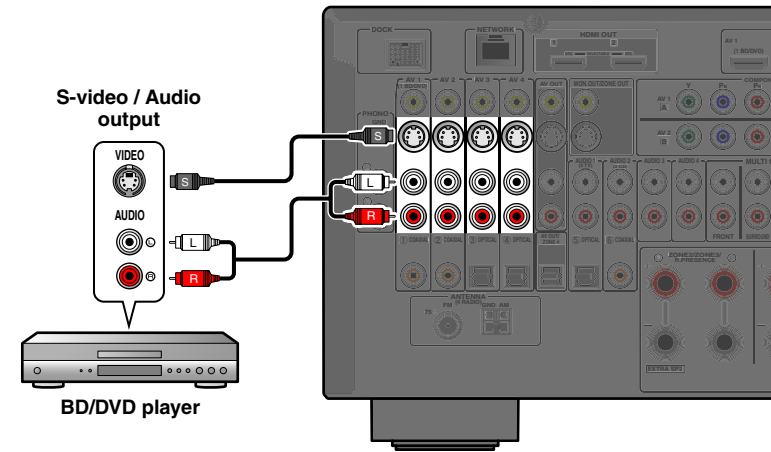

Connecting BD/DVD players and other devices with video cables

Connect the playback device with a video pin cable to one of the AV1-4 input jacks.

Using optical digital audio output sources

Connect the playback device to the AV3 or AV4 jacks.

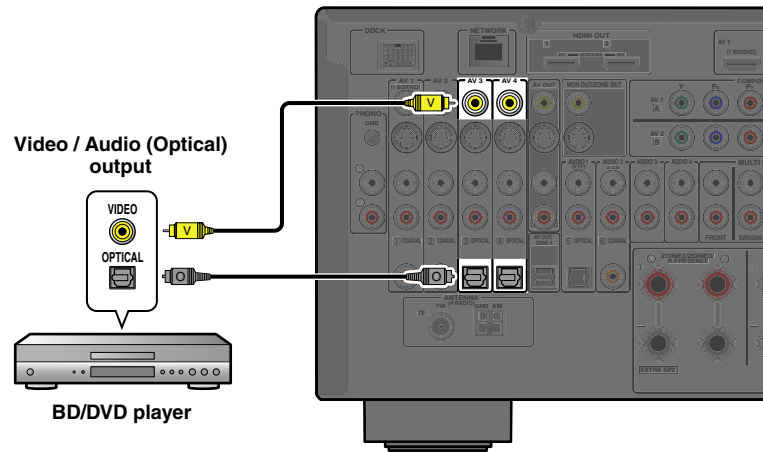

Using analog stereo audio output sources

Connect the playback device to the AV1, AV2, AV3 or AV4 jacks.

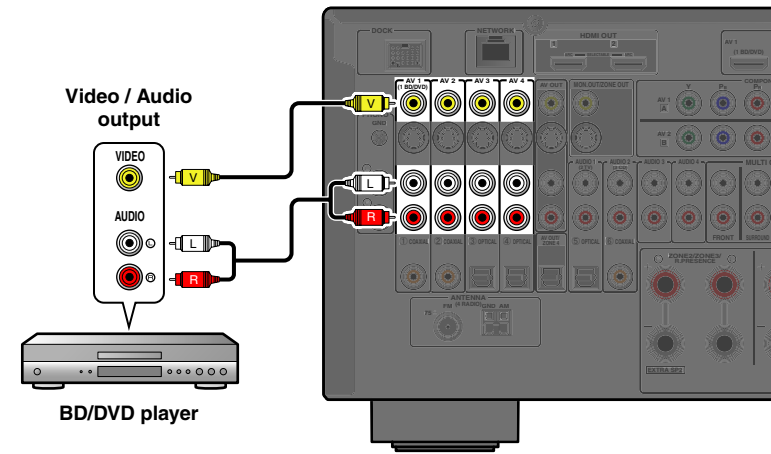

Using coaxial digital audio output sources

Connect the playback device to the AV1 or AV2 jacks.

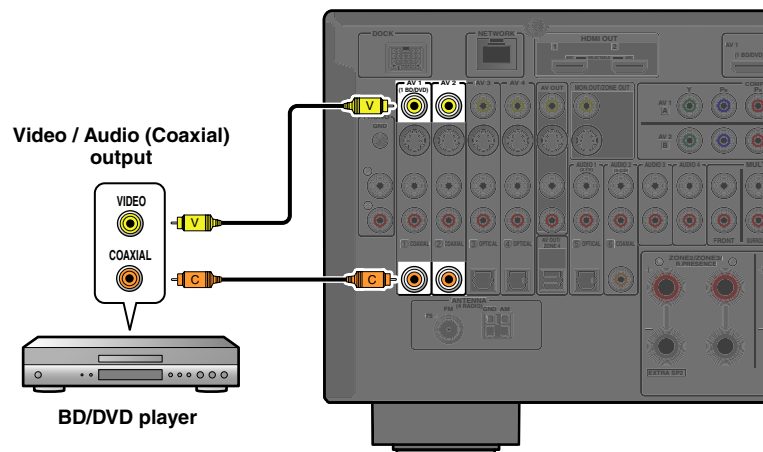

Connecting CD players and other audio devices

Using analog stereo output sources

Connect the playback device to the AUDIO1, AUDIO2, AUDIO3 or AUDIO4 jacks.

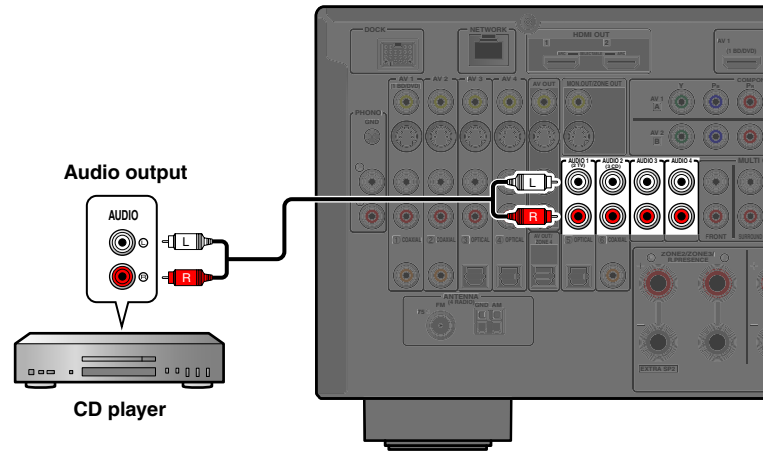

Using optical digital output sources

Connect the playback device to the AUDIO1 jack.

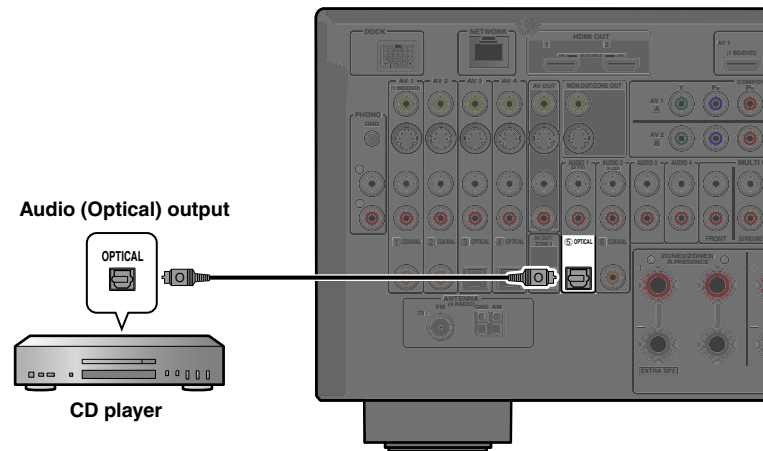

Using coaxial digital output sources

Connect the playback device to the AUDIO2 jack.

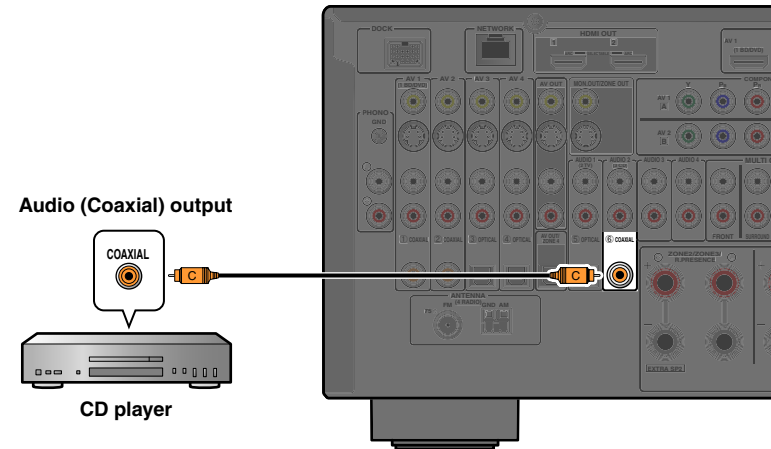

We recommend connecting audio devices with a coaxial digital output to the AUDIO2 coaxial digital jack on this unit. This connection allows you to switch to the AUDIO2 just by pressing the SCENE 3 key ([step. 53](#)).

Connecting a turntable

Connect the audio output of the turntable to PHONO jacks of this unit. 💡1

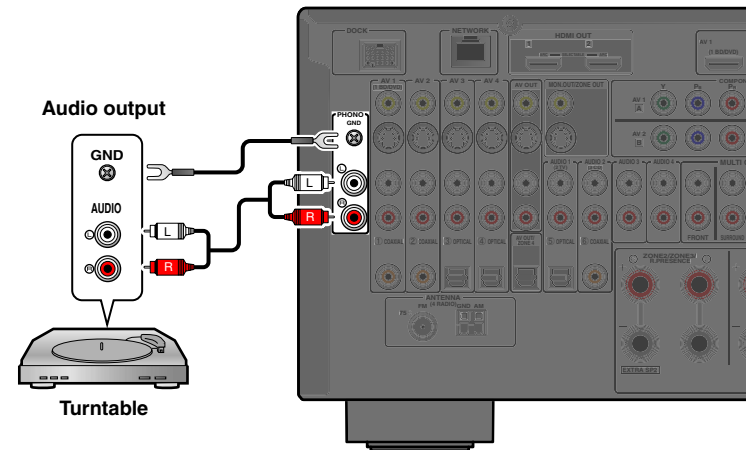

Connect your turntable to the GND terminal of this unit to reduce noise in the signal.

💡 1 : When connecting a turntable with a low-output MC cartridge to the PHONO jacks, use an in-line boosting transformer or MC-head amplifier.

Connecting game consoles or video camcorders

Use the VIDEO AUX jacks on the front panel to temporarily connect devices such as a game console or video camcorder to the receiver.

Select the V-AUX input to use these connected devices.

When connecting an HDMI compatible device

Connect the HDMI output of the device to the HDMI IN jack of the VIDEO AUX.

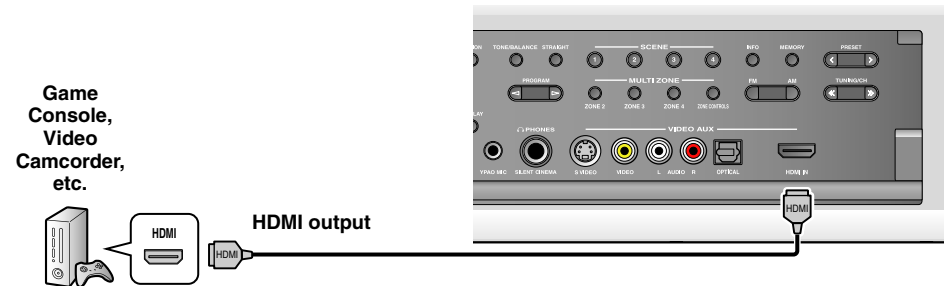

When connecting a non-HDMI compatible device

Connect the video and audio outputs of the device to the VIDEO or S-VIDEO, and AUDIO or OPTICAL jacks of the VIDEO AUX.

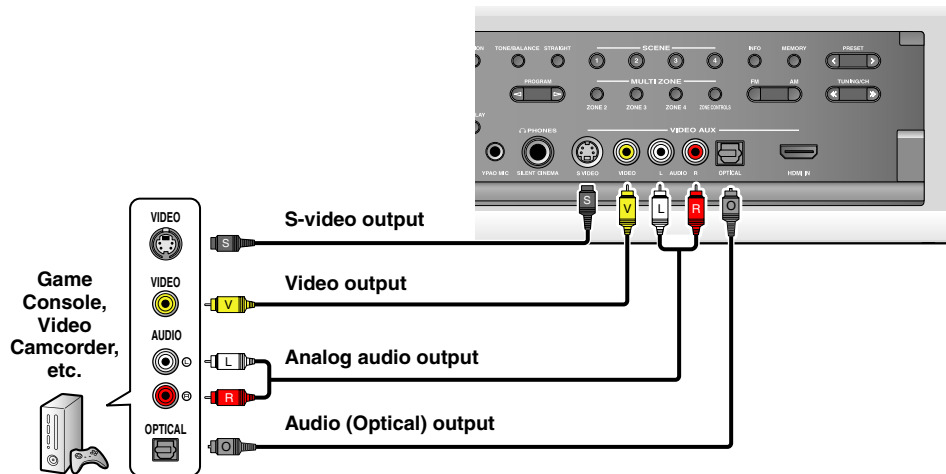

- Be sure to turn down the volume when connecting this unit and the other devices.
- When both the HDMI connection and the analog video/audio connection are performed between the HDMI compatible device and this unit, only the HDMI signal will be input.

Connecting a multi-format player or an external decoder

This unit has 8 sets of input jacks (FRONT L/R, CENTER, SURROUND L/R, SUR. BACK and SUBWOOFER) to input multi-channel analog sound signals. If your playback component, such as a DVD player or SACD player, has multi-channel analog output capability, you can enjoy up to 7.1-channel multi-channel sound. To output multi-channel sound, connect the audio output jacks of your playback component to the MULTI CH INPUT jacks of this unit, and set the input source of this unit to "MULTI CH."

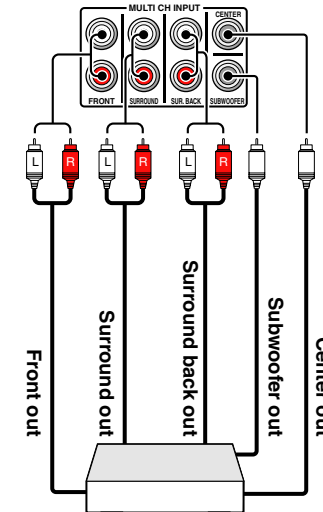

Multi-format player/External decoder (7.1-channel output)

- When you select "MULTI CH" as the input source, the digital sound field processor and tone control are automatically disabled.
- As this unit does not redirect signals input through the MULTI CH INPUT jacks to compensate for missing speakers, make appropriate settings on the multi-format player or the external decoder that suit to the speaker configuration.
- When the input source is switched to "MULTI CH," images input from a component connected to the AV1-7 or VIDEO AUX jacks can be displayed on a video monitor (p. 86). If your DVD player does not support multi-channel digital output, connect it to these input jacks.

Connecting a SCENE link playback-compatible device

When the components are the Yamaha products and have the capability of the transmission of the remote control signals, connect the REMOTE IN and REMOTE OUT jacks to the remote control input and output jack with the monaural analog mini cable as follows.

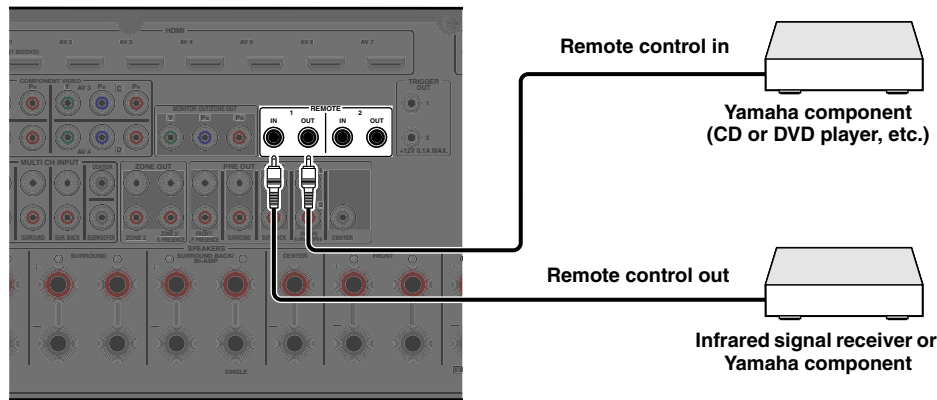

- When a Yamaha component that supports the SCENE link playback function is connected via the REMOTE OUT jack, playback begins automatically when the SCENE function is used ([p. 53](#)).
- If the component connected to the REMOTE OUT jack is not a Yamaha product, set “SCENE IR” in the Scene menu to “Off” ([p. 88](#)).

Using the Trigger function to link external component power

When this unit is connected to a Yamaha subwoofer that supports the system connection or the component with TRIGGER IN jack, you can turn on and off the component by using this unit.

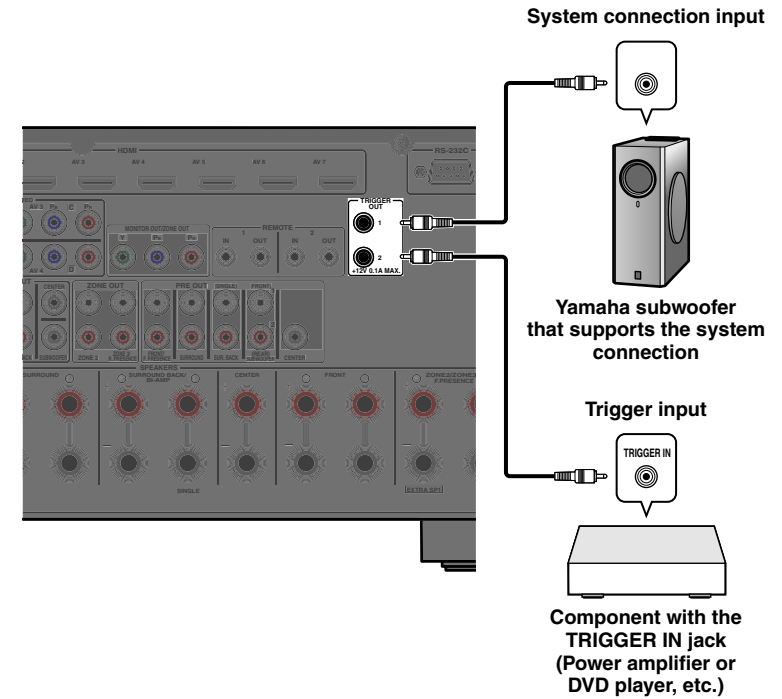

Functions of the TRIGGER OUT jack can be specified ([p. 111](#)).

Connecting audio/video recording devices

This receiver can transmit selected incoming audio/video signals to external components through the AV OUT jacks. You can record these input audio and video signals to VCRs or similar devices, or send them to other TVs or external components.

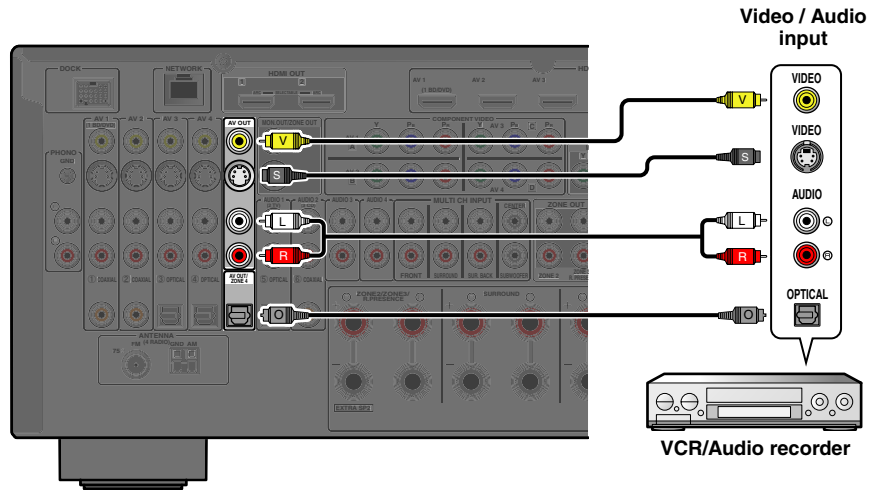

HDMI audio/video signals and component video signals cannot be transmitted from these jacks.

Connecting to the network

To connect this unit to your network, plug one end of a network cable (CAT-5 or higher straight cable) into the NETWORK port of this unit, and plug the other end into one of the LAN ports on your router that supports the DHCP (Dynamic Host Configuration Protocol) server function. To enjoy Internet Radio or music files saved on PC and DLNA server such as NAS (Network Attached Storage), each device must be connected properly in the network.

- Use an STP (shielded twisted pair) cable (commercially available) to connect a network hub or router and this unit.
- If the DHCP server function on your router is disabled, you need to configure the network settings manually ([p. 106](#)).

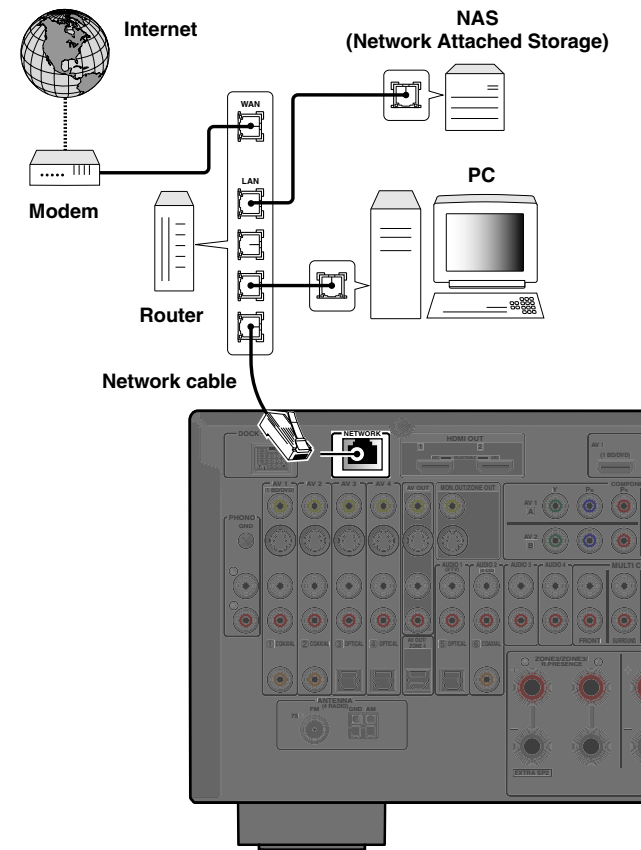

Connecting a USB storage device

Connect a USB memory device or USB portable audio player to the USB port on the front panel of this unit.

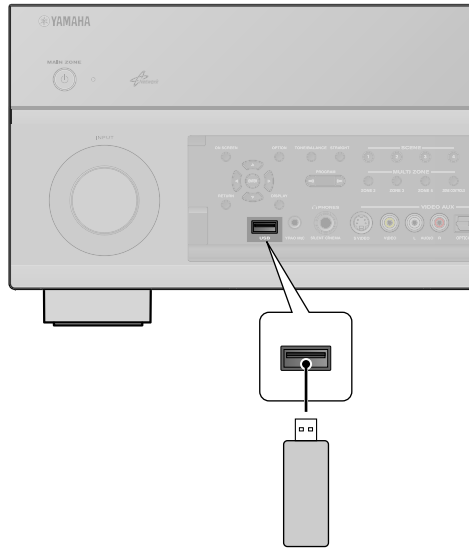

USB memory device or
USB portable audio player

NOTE

Be careful that the USB storage device is facing the correct way when inserted into the USB port of this unit.

Connecting the FM/AM antennas

An indoor FM antenna and an AM loop antenna are supplied with this receiver. Connect these antennas properly to their respective jacks.

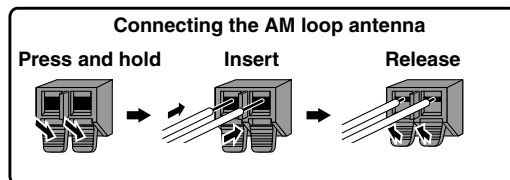
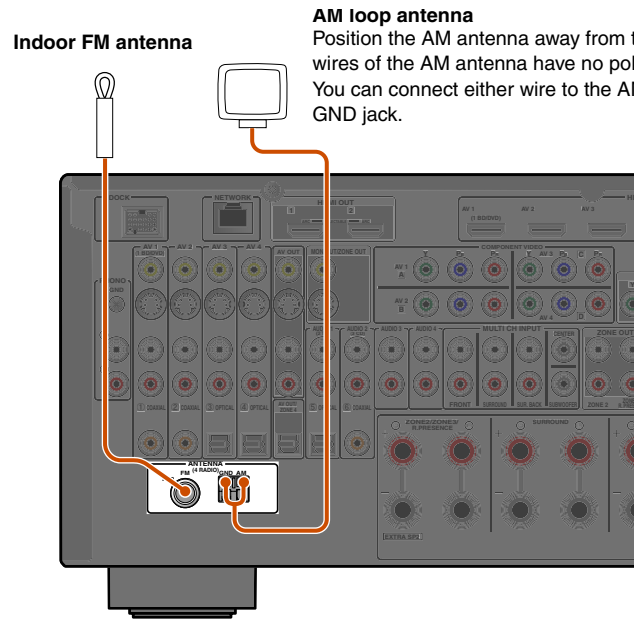

Assembling the AM loop antenna

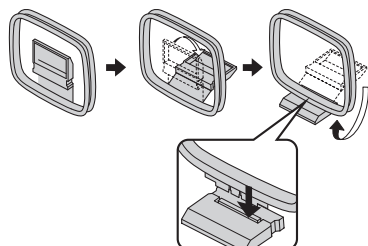

■ Improving FM reception

We recommend using an outdoor antenna. For more information, consult the nearest authorized dealer.

■ Improving AM reception

Connect this unit to an outdoor antenna with a 5 – 10 m vinyl-coated wire. Make sure the AM loop antenna is still connected.

Connecting the GND jack can reduce noise. Connect the jack to a store-bought ground bar or copper plate with a vinyl-covered wire and bury this new attachment in moist ground.

The GND jack is not to be connected to the ground socket of an electrical outlet.

Setting up the speaker parameters automatically (YPAO)

This unit is equipped with a Yamaha Parametric Room Acoustic Optimizer (YPAO) that adjusts the configuration, size, and volume balance of the speakers in order to provide an optimal sound field. Using YPAO allows you to automatically configure settings, such as adjusting speaker output and acoustic parameters to suit your listening room (the room in which this unit is placed). 1

Be aware of the following when using YPAO.

- The amount of time for measurement varies from about two to ten minutes according to settings.
- The test tone is output at high volume. Refrain from using this function at night when it may be a nuisance to others.
- Take care that the test tone does not frighten small children.

YPAO operations can be viewed on the front panel display or TV screen.

1 Check the following before using YPAO.

This unit

- The headphones are removed.

TV

- This unit is connected to the TV correctly.
- The power is turned on.
- The video input to which the video output from this unit has been selected.

Subwoofer

- The power is turned on.
- Volume is set to approximately half, and the cross-over frequency (if present) is set to maximum.

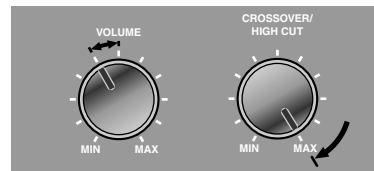

Subwoofer examples

Power amp assign

- “Power Amp Assign” applies the appropriate speaker settings to this unit according to speaker configuration. Refer to “Speaker layout” and “Speaker layout utilizing an external power amplifier” for details ([p. 16](#), [p. 23](#)).

2 Place the supplied YPAO microphone at ear height in your listening position.

Face the head of the YPAO microphone upwards.

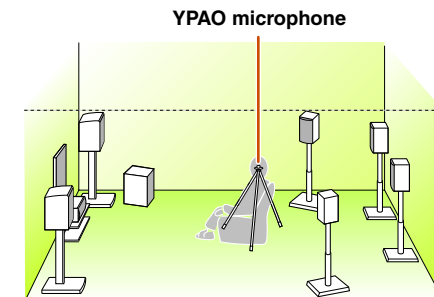

When positioning the microphone, we recommend that you use equipment that allows you to adjust the height (such as a tripod) as a microphone stand. When using a tripod, use the tripod screws to fix the microphone in place.

3 Switch this unit on.

Continues to the next page

 1: When you have changed the number of speakers or the locations in which they are installed, first use YPAO to adjust the speaker balance.



4 Connect the YPAO microphone to the YPAO MIC jack on the front panel.

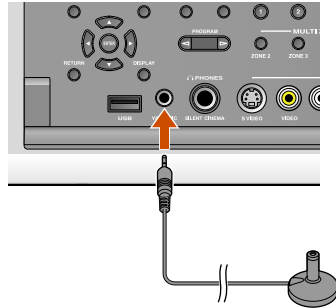

“Mic On View ON SCREEN” appears on the front panel display, and the following display appears on the front panel display or TV screen.

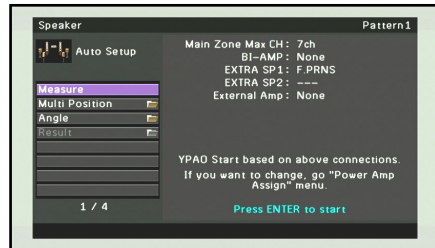

5 Press **9**Cursor Δ / ∇ to select the “Multi Position” and press **9**ENTER to set the number of listening positions to measure.

To measure at the multiple listening positions (up to 8), press **9**Cursor Δ / ∇ to select “Yes” and press **9**ENTER.

To measure at one listening position, press **9**Cursor Δ / ∇ to select “No” and press **9**ENTER.



6 Press **9**Cursor Δ / ∇ to select the “Angle” and press **9**ENTER to select whether or not to measure the angle of speakers.

To measure the angle of speakers, press **9**Cursor Δ / ∇ to select “Yes” and press **9**ENTER.

To not measure the angle of speakers, press **9**Cursor Δ / ∇ to select “No” and press **9**ENTER.

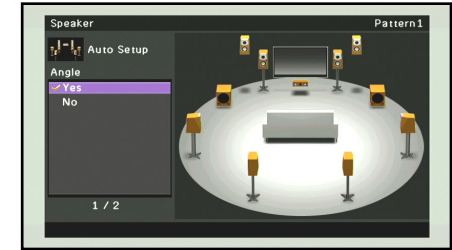

This completes preparation. To achieve more accurate results, take note of the following when measuring acoustics.

- It takes a few minutes for one position to accurately measure acoustics for one position. Keep the room as quiet as possible while acoustics are measured.
- Wait in a corner of the room, or leave it entirely, while acoustics are measured to avoid creating an obstruction between the speakers and the YPAO microphone.

Continues to the next page

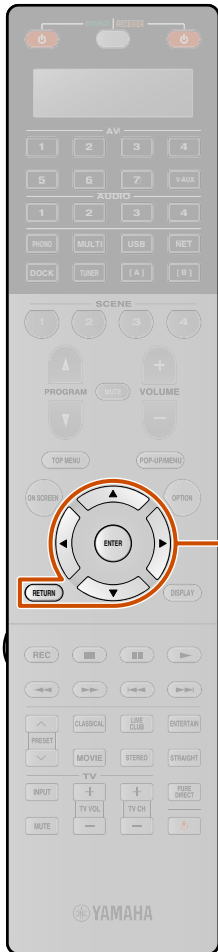

7 Press **9**Cursor Δ / ∇ repeatedly to select the “Measure” and press **9**ENTER to start measurement.

Auto measurement starts in 10 seconds.

- To start the measurement immediately, press **9**ENTER again.
- To cancel the automatic setup, press **9**RETURN and then **9**ENTER.

Display during measurement

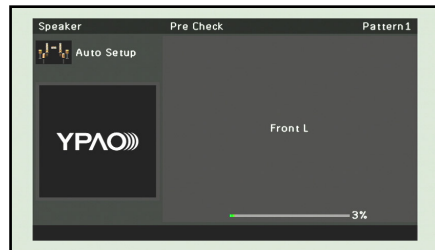

NOTE

If a problem occurs, an error message or report is displayed either during or after acoustic measurement. Refer to “When an error message is displayed during measurement” (p. 48), or “When a warning message is displayed after measurement” (p. 49) to resolve the problem and measure acoustics with YPAO again.

■ When “Multi Position” is set to “No” in step 5

The calculation based on result of measurement starts when measurement finishes without any problem.

When “Angle” is set to “No” in step 6

The following display appears when the calculation finishes without any problems.

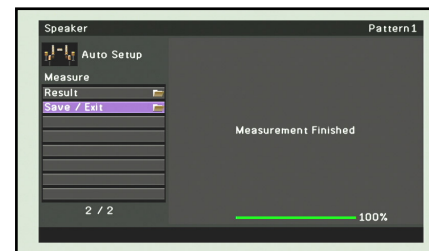

Go to step 14.

■ When “Angle” is set to “Yes” in step 6

The following display appears when the calculation finishes without any problems.

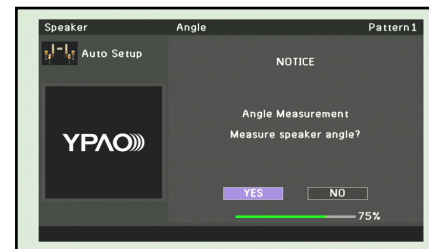

Go to step 9.

■ When “Multi Position” is set to “Yes” in step 5

The following display appears when measurement at the first position finishes without any problems.

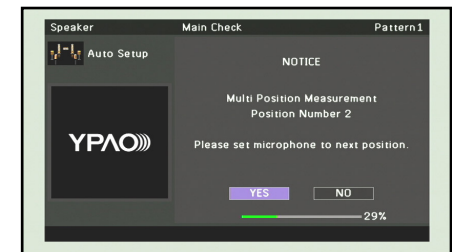

Go to step 8.

Continues to the next page



8 Replace the optimizer microphone at your choosing position and press **ENTER** to restart the automatic measurement.

Auto measurement restarts in 10 seconds.

The following illustration shows how to place the optimizer microphone to optimize the setup of this unit for eight listening positions for example. Up to 8 listening positions can be measured. 💡1

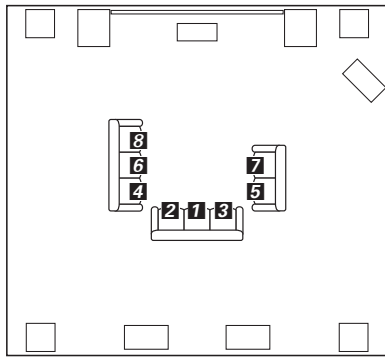

Repeat step 8 until the measurement at all listening positions are made.

The calculation based on result of measurement starts when measurement at the last position finishes without any problem.

When “Angle” is set to “No” in step 6

The following display appears when the calculation finishes without any problems.

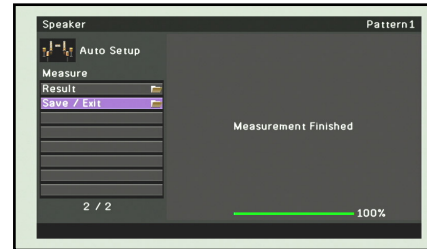

Go to step 14.

When “Angle” is set to “Yes” in step 6

The following display appears when the calculation finishes without any problems.



Go to step 9.

9 Press **Cursor** to select “YES” and press **ENTER**.

The following display appears.



Continues to the next page

💡1: Measure from the most frequent listening position, such as directly in front of the TV, first.



10 Place the supplied microphone base at the listening position you want to be seated most frequently as follows.

Make sure that the arrow mark on the microphone base points the center speaker or between the front left and right speakers.

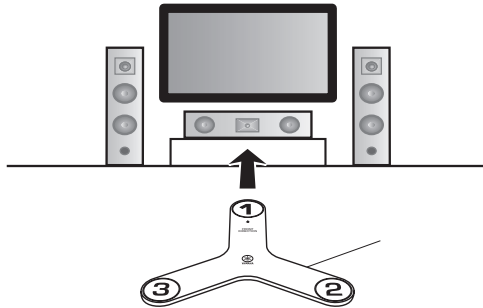

For the accurate measurements of the speaker angles, we strongly recommend that you use a tripod (etc.) to affix the microphone base at the same height as your ears would be when you are seated in your listening position. You can use the attached screw of a tripod (etc.) to fix the microphone base to the tripod (etc.).

11 Place the optimizer microphone to the position on the microphone base.

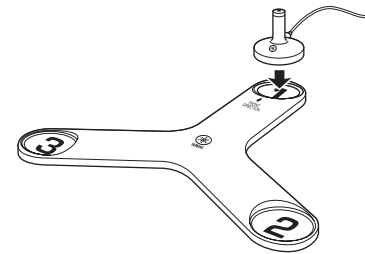

12 After the setting is completed, press **9**ENTER.

This unit starts the measurements of the speaker angles.

13 Repeat steps 11 and 12 for the ② and ③ positions on the microphone base.

The following display appears when measurement of the angle finishes successfully.

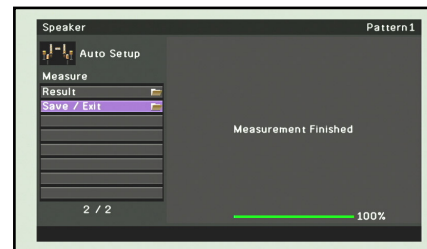

| | | |
|-----------|---|--|
| Result | Displays the results of automatic acoustics measurement. Refer to “Reviewing automatic setup parameters” (p. 47) for details. | |
| Save/Exit | SAVE | Applies the result to the speaker setup and finishes the automatic measurement. 1 |
| | CANCEL | Returns to the previous screen. |
| | EXIT | Finishes the automatic measurement without applying the result to the speaker setup. |

- When the warning message appears on this display, refer to “When an error message is displayed during measurement” (p. 48) for details.
- Press **9**RETURN to return to the previous screen.

Continues to the next page

1: The result of the measurement is assigned to the “Setting Pattern” currently selected. Refer “Setting Pattern” (p. 96) for details on “Setting Pattern.”



14 Press **[9]Cursor** Δ / ∇ to select “Save/Exit” and press **[9]ENTER**.



15 Press **[9]Cursor** \leftarrow / \rightarrow to select “SAVE” and press **[9]ENTER**.

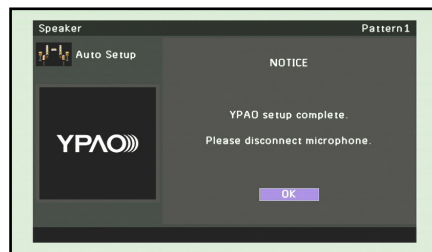

16 Press **[9]ENTER**.
Automatic setup is completed. Disconnect the YPAO microphone.

The YPAO microphone is sensitive to heat. When you have finished measuring, store the microphone out of direct sunlight, and away from locations that may experience high temperatures, such as on top of AV equipment.

Reviewing automatic setup parameters

The results of automatic acoustics measurement can be reviewed once measurement is complete.

1 Press **[9]Cursor** Δ / ∇ repeatedly to select “Result” and press **[9]ENTER** immediately after the automatic measurement.

The Result menu can be viewed only by performing the automatic measurement.

The results of acoustics measurement are displayed.

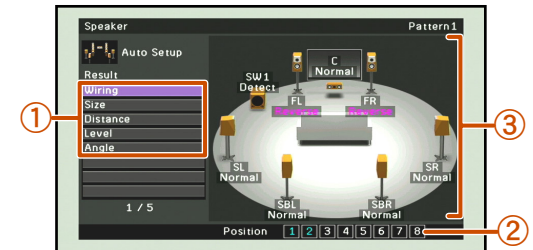

- ① **List of menu items**
Menu items available in the Result menu are displayed.
- ② **Number of measurement**
Indicates the number of measurements for multiple listening positions.
- ③ **Diagram**
Shows the speaker setup and sound adjustment as diagram.

Continues to the next page

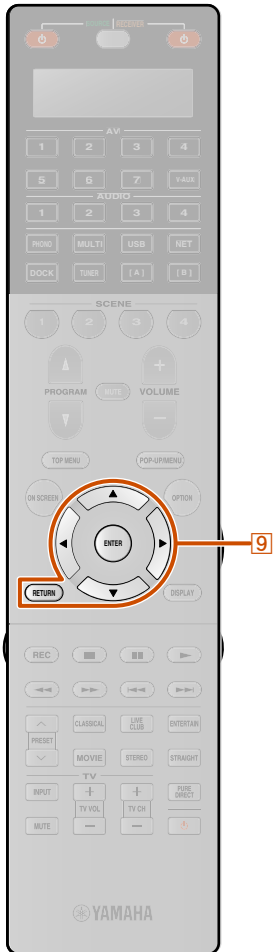

2 Select the desired menu item (or enable a function) using **9**Cursor Δ / ∇ / \leftarrow / \rightarrow and **9**ENTER.

| | |
|----------|--|
| Wiring | Displays the speakers connected to this unit and the polarity of each connected speaker. <ul style="list-style-type: none"> • “Normal” is displayed when the polarity of the connected speaker is normal. • “Reverse” is displayed when the polarity of the connected speaker is opposite. |
| Size | Displays the size of the connected speakers and the bass cross over frequency (“Bass Crossover”). <ul style="list-style-type: none"> • “Large” is displayed when the connected speaker has the ability to reproduce the low-frequency signals effectively. • “Small” is displayed when the connected speaker does not have the ability to reproduce the low-frequency signals effectively. |
| Distance | Displays the distance from the listening position to speakers. The unit for distance can be switched between “ft” (feet) and “m” (meter) by pressing 9 Cursor \leftarrow / \rightarrow . |
| Level | Displays the result of the adjustment of each connected speaker output level. |

| | |
|--|---|
| Angle | Displays the angles of the front speakers, surround speakers, front presence speakers and rear presence speakers at the measured point. |
| Setup Reload  | Clears the fine-adjustment with Manual Setup and reloads the result of automatic setup. For details, refer to “Reloading automatic setup parameters.” |

3 Press **9**RETURN to finish the Result menu.

The result of automatic setup can be fine-tuned manually by “Manual Setup.” Refer to “Manual speaker setup” ([p. 96](#)) for details.

Reloading automatic setup parameters

If you are not satisfied with the fine-adjustment of setup parameters with Manual Setup, the result of automatic setup saved on this unit can be reloaded. Select “Setup Reload” in the Result menu.

NOTE

When automatic setup parameters are reloaded, manually configured settings are cleared. To avoid clearing manually configured settings by reloading automatic setup parameters, see “Prohibiting setting changes” ([p. 112](#)).

When an error message is displayed during measurement

See “Error messages” ([p. 50](#)) for instructions on resolving the problem and measure acoustics again.

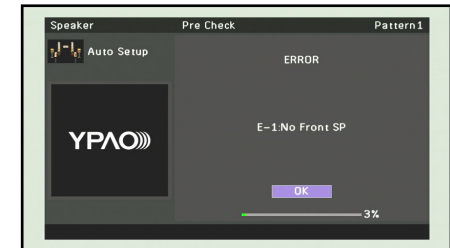

Check the error code displayed and use YPAO to measure acoustics again as described below.

When “E-1,” “E-2,” “E-3,” “E-4,” “E-6” or “E-11” is displayed:

- 1 Press **9**ENTER.
- 2 Press **9**Cursor \rightarrow to select “EXIT.”
- 3 Press **9**ENTER to terminate YPAO, and switch the unit to standby mode.
- 4 Check that the speakers are properly connected.
- 5 Turn on the unit and use YPAO again.

Continues to the next page

 **1**: This item is displayed after the fine-adjustment is performed with “Manual Setup.” Use this item to return the settings to the result of automatic setup.

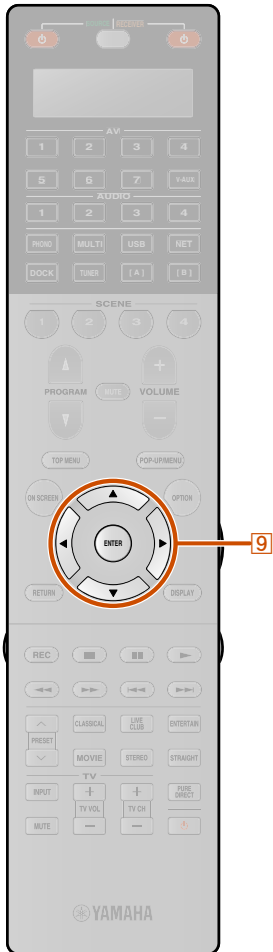

When “E-7” or “E-8” is displayed:

- 1 Press **[9]ENTER**.
- 2 Check that the environment is suitable for accurate measurement.
- 3 Press **[9]Cursor >** to select “RETRY.”
- 4 Press **[9]ENTER** to use YPAO again.

When “E-5” or “E-9” is displayed:

- 1 Press **[9]ENTER**.
- 2 Check that the environment is suitable for accurate measurement.
- 3 Press **[9]Cursor </>** to select a option.
PROCEED:
 When “E-5” is displayed, measurement can proceed. However, the measurement in noisy environment may reduce the accuracy.
 When “E-9” is displayed, resume the aborted step.
RETRY:
 Restart measurement from the beginning.
- 4 Press **[9]ENTER** to execute the selected option.

When “E-10” is displayed:

- 1 Press **[9]ENTER**.
- 2 Press **[9]Cursor >** to select “EXIT.”
- 3 Press **[9]ENTER** to terminate YPAO, and switch the unit to standby mode.
- 4 Turn on the unit and use YPAO again.

When a warning message is displayed after measurement

See “Warning messages” (p. 50) for instructions on resolving the problem. The speaker causing the problem can be confirmed from the TV screen display.

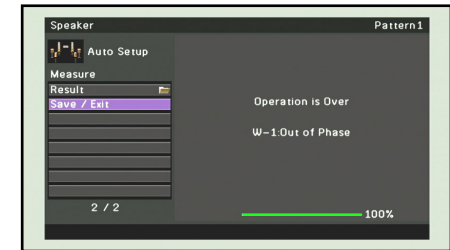

NOTE

Although the results of acoustics measurement can be applied when a warning message is displayed, optimal sound will not be achieved. Resolving the problem and using YPAO to measure acoustics again is recommended.

To exit YPAO with some options

- 1 Use **[9]Cursor Δ / ▽** to select “Save/Exit” and press **[9]ENTER**.
- 2 Use **[9]Cursor </>** to select one of the following options and press **[9]ENTER**.
SAVE:
 Exits YPAO applying the results of measurement.
CANCEL:
 Returns to the previous screen (warning message screen).
EXIT:
 Exits YPAO without saving the results.

Message list

NOTE

If the following messages appear, resolve the problems that have occurred and carry out the measurement process again.

When a warning message is displayed before measurement

| | | |
|---------------|--|--|
| Connect MIC! | The YPAO microphone is not connected. | Connect the YPAO microphone to the YPAO MIC jack on the front panel. |
| Unplug HP! | The headphones are connected. | Remove the headphones. |
| Memory Guard! | The settings of this unit are protected. | Set "Memory Guard" in the Setup menu to "Off" (see p. 112). |

Error messages

| | | |
|----------------------|--|---|
| E-1: No Front SP | The unit was not able to find the front channel. | Check that the left and right front speakers are connected correctly. |
| E-2: No Sur. SP | The unit was only able to find one of side of the surround channels. | Check that the left and right surround speakers are connected correctly. |
| E-3: No F.PRNS SP | The unit was only able to find one of side of the front presence channels. | Check that the left and right front presence speakers are connected correctly. |
| E-4: SBR→SBL | Only one surround back speaker is connected and only the right side surround back channel sound is detected. | When only one surround back speaker is connected, connect to the left side (SINGLE) terminal. |
| E-5: Noisy | The noise is too loud, preventing accurate measurements from being taken. | Measure again in quiet surroundings. Turn off any devices in the room that may be emitting noise, or place them further away from the YPAO microphone. When this message is displayed, selecting "PROCEED" will allow you to continue measuring. However, we recommend resolving the problem and measuring again, as continuing measurement without doing so will not give accurate results. |
| E-6: Check Sur. | Even though surround left and right speakers are not connected, only the surround back speakers are connected. | When using surround back speakers, connection of the surround left/right speakers is necessary. |
| E-7: No MIC | The YPAO microphone has been removed. | While measuring, take care not to touch the YPAO microphone. |

| | | |
|-------------------------|---|--|
| E-8: No Signal | The YPAO microphone could not distinguish a test tone. | Check that the YPAO microphone has been installed correctly. |
| | | Check that each speaker has been connected and installed correctly. |
| | | The YPAO microphone or the YPAO MIC jack may be broken. Inquire at the retailer where you purchased this unit, or the nearest Yamaha service center. |
| E-9: User Cancel | You have carried out an operation that has cancelled the measuring process. | Carry out the measuring process again. Do not operate this unit by, for example, adjusting the volume. |
| E-10: Internal Error | An internal error has occurred. | Carry out the measuring process again. Contact a Yamaha service center if "E-10" is displayed again. |
| E-11: No R.PRNS SP | The unit was only able to find one of side of the rear presence channels. | Check that the left and right rear presence speakers are connected correctly. |

Warning messages

| | | |
|-----------------------|---|--|
| W-1: Out of Phase | The speakers displayed are connected with the opposite polarity. Depending on the type of speakers you are using and the environment in which you have them installed, this message may occur even if the speakers are connected correctly. | Depending on the type of speakers, "W-1" may display even if the speakers are connected correctly. |
| | | Check that the speaker polarity + (positive), and - (negative) are correct. If these are connected correctly, you can use the speakers normally even this message appears. |
| W-2: Over 24m/80ft | The speakers displayed are separated from the listening position by more than 24 m, and cannot be adjusted correctly. | Install the speakers with 24 m of the listening position. |
| W-3: Level Error | Volume level varies greatly for individual channels, and cannot be adjusted correctly. | Check that all speakers are installed in the same surroundings. |
| | | Check that the speaker polarity + (positive), and - (negative) are correct. |
| | | We recommend the same speakers or speakers with as similar specifications as possible. Adjust the volume of the subwoofer. |

If "W-2" or "W-3" appears, you can apply measurement results, but they will not give optimal results. We recommend that you resolve the problem and carry out the measurement process again.



PLAYBACK

Basic playback procedure

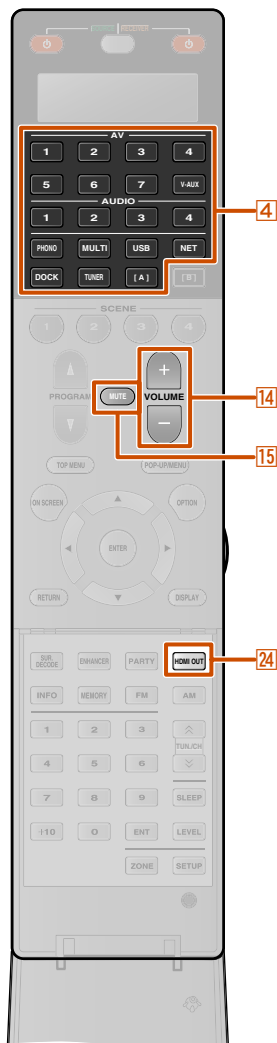

1 Turn on external components (TV, DVD player, etc.) connected to this unit.

2 Use the **[4] Input selector** to select the input source.

The name of the selected input source is displayed on the front panel display. **1**

When USB, NET, DOCK or TUNER is selected, the content window is displayed ([p. 65](#)).

3 Play the external component that you have selected as the source input, or select a radio station on the tuner.

Refer to the instruction manuals provided with the external component for details on playback.

For details on the following operations, refer to the corresponding pages:

- “FM/AM tuning” ([p. 66](#))
- “Playing back tunes on the PC” ([p. 69](#))
- “Playing back tunes on the USB storage devices” ([p. 71](#))
- “Listening to the Internet Radio” ([p. 73](#))
- “Playing back tunes from your iPod™/iPhone™” ([p. 76](#))
- “Playing back tunes from Bluetooth™ components” ([p. 80](#))

4 Press **[14] VOLUME +/-** to adjust the volume.

To mute the output.

Press **[15] MUTE** to mute the audio output.

Press **[15] MUTE** again to unmute.

Selecting the active HDMI OUT jack

Use this function to select the HDMI OUT jack(s) used to output signal.

Press **[24] HDMI OUT** repeatedly to select setting.

The HDMI output setting changes as follows.



| | |
|---------|--|
| OUT 1+2 | Outputs the signal at both the HDMI OUT 1 and HDMI OUT 2 jacks simultaneously. |
| OUT 1 | Outputs the signals at the HDMI OUT 1 jack. |
| OUT 2 | Outputs the signals at the HDMI OUT 2 jack. |
| Off | Any signals are not output at the HDMI OUT 1 and HDMI OUT 2 jacks. Select this setting when you do not use the video monitor connected to one of the HDMI OUT jacks. |

- The HDMI OUT jack that utilizes the HDMI Control function can be selected with “Control Select” ([p. 104](#)).
- When “HDMI Control” is set to “On,” the HDMI OUT jack selected with “Control Select” is automatically enabled in addition to the HDMI OUT jack selected here by commands from the external component supporting HDMI Control connected to the jack ([p. 104](#)).
- The active HDMI OUT jack(s) can be registered with the SCENE function ([p. 87](#)).

1 : You can change the input source name displayed on the front panel display as necessary ([p. 85](#)).

■ Adjusting high/low-frequency sound (Tone control)

You can adjust the balance of the high-frequency range (Treble) and low-frequency range (Bass) of sounds output from the front left and right speakers to obtain desired tone.

The tone control of the speakers or headphones can be set separately. Set the headphone tone control with the headphones connected.

1 Press TONE/BALANCE on the front panel repeatedly to select “Treble” or “Bass.”

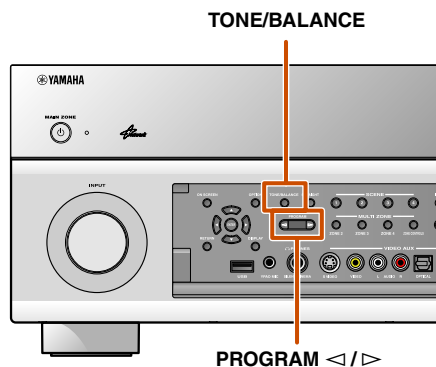

The current setting is displayed on the front panel display.



2 Press PROGRAM </> to adjust the output level in the following frequency range.

| | |
|-----------------------|--------------------|
| Adjustable range | -6.0 dB to +6.0 dB |
| Adjustment increments | 0.5 dB |

The display returns to the previous display soon after you release the key.

- The tone control settings are not effective when this unit is in the Pure Direct Mode or “MULTI CH” is selected as an input source.
- If you set the balance extremely off, sounds may not match those from other channels well.
- The tone control can also be adjusted in the Option menu ([p. 63](#)).

Changing input settings with a single key (SCENE function)

This unit has a SCENE function that allows you switch this unit on and change input sources, the settings of Audio Select, HDMI Output, Sound Program, Pure Direct Mode, Tone Control, Adaptive DRC, and Compressed Music Enhancer with one key.

Selecting the SCENE suitable for the external component

At initial factory settings, SCENE functions are configured for the following components. Select a scene according to the component that you want to play back.

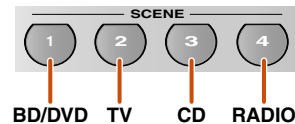

SCENE 1

Settings are configured for viewing DVD or Blu-ray Disc content. Press this key and play back content from the DVD or Blu-ray Disc player connected to the AV1 jack on this unit.

SCENE 2

The settings are configured for viewing a TV content. Press this key and turn on the TV connected to the AUDIO1 jack on this unit.

SCENE 3

The settings are configured for listening to CD content. Press this key and play back the CD player connected to the AUDIO2 jack on this unit.

SCENE 4

Settings are configured for listening to a radio station. Press this key and tune into a radio station.

SCENE 5-12

The nothing is registered on the scenes at initial factory setting. The favorite settings can be registered on the scenes and reloaded by using “Save” and “Load” in Scene menu. For details, refer to “Scene menu” (p. 88).

- When switching scenes, also change the external component that the remote control operates (p. 115).
- We recommend that selecting a scene and editing the SCENE function are performed in the Scene menu (p. 87).
- This unit has eight additional scene functions. After selecting one of these scenes, one of the additional eight scenes may also be selected (p. 88).
- Press and hold **5**SCENE key for about three seconds to register the current setting to the scene.

Four scenes are available for different uses, such as playing movies or music. The following settings such as input sources, sound programs, and HDMI Output are provided at initial factory settings. Settings that are not checked () are not enabled when a scene key is pressed. Use “Load” in the Scene menu to check settings to be enabled. Refer to “Adjusting settings registered with the SCENE function” (p. 88) for details.

| SCENE | Input | Audio Select | HDMI Output | Sound Program | Pure Direct Mode | Tone Control | Adaptive DRC | Compressed Music Enhancer | CINEMA DSP 3D Mode | Dialogue Lift | Extended Surround | Video Adjustment | Video Processing | Master Volume | Lipsync | Delay | Setting Pattern | PEQ Select |
|--------------------------------|-------------------------------------|-------------------------------------|-------------------------------------|-------------------------------------|-------------------------------------|-------------------------------------|-------------------------------------|-------------------------------------|-------------------------------------|--------------------------|--------------------------|--------------------------|--------------------------|--------------------------|--------------------------|--------------------------|--------------------------|--------------------------|
| | <input checked="" type="checkbox"/> | <input checked="" type="checkbox"/> | <input checked="" type="checkbox"/> | <input checked="" type="checkbox"/> | <input checked="" type="checkbox"/> | <input checked="" type="checkbox"/> | <input checked="" type="checkbox"/> | <input checked="" type="checkbox"/> | <input checked="" type="checkbox"/> | <input type="checkbox"/> | <input type="checkbox"/> | <input type="checkbox"/> | <input type="checkbox"/> | <input type="checkbox"/> | <input type="checkbox"/> | <input type="checkbox"/> | <input type="checkbox"/> | <input type="checkbox"/> |
| 1 (BD/DVD Movie Viewing) | AV1 | Auto | OUT 1+2 | Drama | Auto | Bass: 0.0 dB Treble: 0.0 dB | On | Off | On | 0 | Auto | Off | Off | -40.0 dB | Auto | 0 ms | Pattern1 | Natural |
| 2 (TV Viewing) | AUDIO1 | Auto | OUT 1+2 | STRAIGHT | Auto | Bass: 0.0 dB Treble: 0.0 dB | On | On | On | 0 | Auto | Off | Off | -40.0 dB | Auto | 0 ms | Pattern1 | Natural |
| 3 (CD Music Listening) | AUDIO2 | Auto | OUT 1+2 | STRAIGHT | Auto | Bass: 0.0 dB Treble: 0.0 dB | Off | Off | On | 0 | Auto | Off | Off | -40.0 dB | Auto | 0 ms | Pattern1 | Natural |
| 4 (Radio Listening) | TUNER | --- | OUT 1+2 | STRAIGHT | Auto | Bass: 0.0 dB Treble: 0.0 dB | Off | On | On | 0 | Auto | Off | Off | -40.0 dB | Auto | 0 ms | Pattern1 | Natural |

Enjoying favorite sound field effect

This unit is also equipped with a Yamaha digital sound field processing (DSP) chip. Multi-channel playback from almost any audio source can be enjoyed using a variety of sound decoders and various sound field effect programs stored on the chip. Sound field effect programs built into this unit are called “sound programs.”

Selecting sound programs and sound decoders

This unit offers sound programs in many different categories suitable for movies, music and other uses. Choose a sound program that sounds best with the source you are playing back, rather than relying on the name or explanation of the program.

Sound programs are stored for each input source. When you change the input source, the sound program previously selected for that input source is applied again.

Selecting sound program (p. 57):

CLASSICAL category: Press **19** **CLASSICAL** repeatedly 🌱1

LIVE/CLUB category: Press **19** **LIVE/CLUB** repeatedly 🌱1

ENTERTAIN category: Press **19** **ENTERTAIN** repeatedly 🌱1

MOVIE category: Press **19** **MOVIE** repeatedly 🌱1

Selecting stereo reproduction (p. 56):

Press **19** **STEREO** repeatedly 🌱1

Selecting surround decoder:

Press **20** **SUR. DECODE** repeatedly 🌱1

Turning on Straight decoding mode (p. 55):

Press **19** **STRAIGHT**

Turning on Pure Direct Mode (p. 56):

Press **19** **PURE DIRECT**

Turning on Compressed Music Enhancer (p. 56):

Press **20** **ENHANCER** repeatedly

Sound program categories



- You can use the speaker indicators on the front panel display to check what speakers are currently outputting sound (p. 11).
- You can adjust sound field elements (sound field parameters) for each of the programs (p. 90).

Enjoying surround sound with the CINEMA DSP function

Enjoying sound programs without surround speakers

This unit allows you to use virtual surround speakers to enjoy sound field surround effects, even without any surround speakers (Virtual CINEMA DSP mode). You can even enjoy surround sound presence with just a minimal configuration of the front speakers only. This unit will switch to Virtual CINEMA DSP mode automatically when Surround is set to “None” in Configuration (p. 98). 🌱2

Enjoying sound programs with headphones

Even when headphones are connected, you can enjoy the reproduction sound field presence with ease (SILENT CINEMA mode). 🌱3

🌱1 : A sound program, stereo reproduction option or sound decoder can also be selected by pressing **6** **PROGRAM** Δ / ∇ .

🌱2 : However, Virtual CINEMA DSP mode is not available under the following conditions:

- When headphones are connected to this unit.
- When a “7ch Stereo” or “2ch Stereo” sound program is selected.
- When Pure Direct Mode or straight decoding mode is selected.

🌱3 : However, SILENT CINEMA mode is not available under the following conditions:

- When a “2ch Stereo” sound program is selected.
- When Pure Direct Mode or straight decoding mode is selected.



Enjoying more spatial sound fields (CINEMA DSP 3D mode)

CINEMA DSP 3D mode creates an intensive and accurate stereoscopic sound field in the listening room. Connection of presence speakers is recommended to take full advantage of the effects of CINEMA DSP 3D mode. Do the following steps. 

- Connect the front presence speakers to the EXTRA SP1 jacks and set the speakers to use. For more spatial sounds, connect the rear presence speakers to the EXTRA SP2 jacks and set the speakers to use (p. 20).
- Enable CINEMA DSP 3D in the Option menu (p. 61).

When a sound program runs in CINEMA DSP 3D mode, the CINEMA DSP 3D indicator on the front panel lights up.



Lights up

Enjoying sound programs without presence speakers

This unit allows you to use virtual presence speakers to create an intensive and accurate stereoscopic sound field, even when no presence speakers are connected (Virtual CINEMA DSP 3D mode). You can even enjoy surround sound presence with front speakers, center speaker, and surround speakers.

This unit automatically switches to Virtual CINEMA DSP 3D mode when presence speakers are not available. Do the following steps.

- At minimum, connect the front speakers, center speaker, and surround speakers.
- Enable the center speaker and surround speakers in “Configuration” (p. 98).
- Enable CINEMA DSP 3D in the Option menu (p. 63).

Enjoying unprocessed playback (Straight decoding mode)

Use straight decoding mode when you want to playback sound without sound field processing. You can playback as follows in straight decoding mode.

2-channel sources such as CD

Stereo sound plays through the front left and right speakers.

Multi-channel playback sources such as BD/DVD

Plays back audio from a playback source without applying sound field effects, using an appropriate decoder to split the signal into multiple channels.

Press **19** **STRAIGHT** to enable the straight decoding mode.



To disable straight decoding mode, press **19** **STRAIGHT** again.



Previously selected program

 **1**: However, CINEMA DSP 3D mode is not available under the following conditions:

- When headphones are connected to this unit.
- When a “7ch Stereo” or “2ch Stereo” sound program is selected.
- When Pure Direct Mode or straight decoding mode is selected.

Enjoying Hi-Fi Sound Quality (Pure Direct Mode)

Use Pure Direct Mode to enjoy the pure high fidelity sound of the selected source. When Pure Direct Mode is enabled, this unit plays back the selected source with the least circuitry. 

Press **[19] PURE DIRECT** to turn Pure Direct Mode on. 

To disable Pure Direct Mode, press **[19] PURE DIRECT** again.

Enjoying stereo playback

Select “2ch Stereo” from the sound programs when you want to playback 2-channel stereo sound (from the front speakers only), regardless of the playback source. Selecting “2ch Stereo” will playback as follows for the playback of CD and BD/DVD sources.

2-channel sources such as CD

Stereo sound plays back through the front speakers.

Multi-channel sources such as BD/DVD

Playback channels other than the front channels in the playback source are mixed with the front channels and played back through the front speakers.

Press **[19] STEREO** repeatedly to select “2ch Stereo.”



To disable stereo playback, press any of the **[19] Sound selection keys** to select a sound program other than “2ch Stereo.”

Enjoying compressed music source with better sound quality (Compressed Music Enhancer)

Compressed Music Enhancer improves the sound quality of the compressed music source closer to its original depth and width. 

This mode can be used along with any other DSP modes.

Press **[20] ENHANCER** to turn Compressed Music Enhancer on.





Lights up when the Compressed Music Enhancer is active

To disable Compressed Music Enhancer, press **[20] ENHANCER** again.



-  **1** : The following features are disabled in Pure Direct Mode.
- sound program, tone control, PEQ Select, and Adaptive DRC
 - displaying and operating the Option menu and ON SCREEN menu

-  **2** : While Pure Direct Mode is on, the front panel display screen turns off in order to reduce noise. When turning Pure Direct Mode off, the screen returns on.







-  **3** : However, Compressed Music Enhancer is not available in the following audio:
- Signals of which sampling rate is over 48kHz
 - High Definition stream

Sound programs

 in the table indicates the sound program for CINEMA DSP.





Category: CLASSICAL

This sound field is suitable when listening to music sources such as CDs.

| | |
|---|---|
| Hall in Munich  | This sound field simulates a concert hall with approximately 2500 seats in Munich, using stylish wood for the interior finishing as normal standards for European concert halls. Fine, beautiful reverberations spread richly, creating a calming atmosphere. The listener's virtual seat is at the center left of the arena. |
| Hall in Vienna  | This is an approximately 1700-seat, middle-sized concert hall with a shoebox shape that is traditional in Vienna. Pillars and ornate carvings create extremely complex reflections from all around the audience, producing a very full, rich sound. |
| Hall in Amsterdam  | The large, shoe box shaped hall seats about 2200 around the circle stage. Reflections are rich and pleasing while the sound travels freely. |
| Church in Freiburg  | Located in the south of Germany, this grand, stone-built church has a pointed tower at 120 meters in height. Its long and narrow shape and the high ceiling enable the elongated reverberation time and limited initial reflection time. Thus, the rich reverberation rather than the sound itself reproduces the atmosphere of the church. |
| Church in Royaumont  | This program features the sound field created by the refectory (dining hall) of a beautiful medieval Gothic monastery located in Royaumont on the outskirts of Paris. |
| Chamber  | This program creates a relatively wide space with a high ceiling like an audience hall in a palace. It offers pleasant reverberations that are suitable for courtly music and chamber music. |





Category: LIVE/CLUB

This sound field is suitable when listening to music sources such as CDs.

| | |
|--|--|
| Village Vanguard  | The Jazz club is on 7th Avenue, New York. This small club with the low ceiling makes the powerful reflections converge toward the stage located in the center. |
| Warehouse Loft  | The warehouse resembles some lofts in Soho. Sound reflects off the concrete walls clearly with a lot of energy. |
| Cellar Club  | This program simulates a live house with a low ceiling and homey atmosphere. A realistic, live sound field features powerful sound as if the listener is in a row in front of a small stage. |
| The Roxy Theatre  | This is the sound field of a rock music live house in Los Angeles, with approximately 460 seats. The listener's virtual seat is at the center left of the hall. |
| The Bottom Line  | This is the sound field at stage front in The Bottom Line, a famous New York jazz club once. The floor can seat 300 people to the left and right in a sound field offering real and vibrant sound. |

Category: ENTERTAINMENT







Sound programs are optimized for video sources such as TV programs and games.

| | |
|--|--|
| Sports  | This program allows the listeners to enjoy stereo sport broadcasts and studio variety programs with enriched live feeling. In sports broadcasts, the voices of the commentator and sportscaster are positioned clearly at the center while the atmosphere of the stadium expands in an optimal space to offer the listeners a feeling of presence in the stadium. |
| Action Game  | This sound field is suitable for action games such as car racing, fighting games and FPS games. The reality of, and emphasis on, various effects makes the player feel like they are right in the middle of the action, allowing for greater concentration. Use this program in combination with Compressed Music Enhancer for a more dynamic and strong sound field. |
| Roleplaying Game  | This sound field is suitable for role-playing and adventure games. This program adds depth to the sound field for natural and realistic reproduction of background music, special effects and dialog from a wide variety of scenes. Use this program in combination with Compressed Music Enhancer for a more clear and spatial sound field. |
| Music Video  | This sound field offers an image of a concert hall for live performance of pop, rock and jazz music. The listener can indulge oneself in a hot live space thanks to the presence sound field that emphasizes the vividness of vocals and solo play and the beat of rhythm instruments, and to the surround sound field that reproduces the space of a big live hall. |
| Recital/Opera  | This program controls the amount of reverberations at an optimum level and emphasizes the depth and clarity of human voices. "Recital/Opera" offers the reverberations of an orchestra box in front the listener at the same time as providing the acoustic positioning and feeling of presence on the stage. The surround sound field is relatively moderate, but the data for concert hall effects are used to represent the inherent beauty of music. The listener will not be fatigued even after long hours of opera entertainment. |

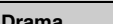

Category: MOVIE

Sound programs optimized for viewing video sources such as movies.

| | |
|--|--|
| Standard  | This program creates a sound field emphasizing the surround feeling without disturbing the original acoustic positioning of multi-channel audio such as Dolby Digital and DTS. It has been designed with the concept of an ideal movie theater, in which the audience is surrounded by beautiful reverberations from the left, right and rear. |
| Spectacle  | This program represents the spectacular feeling of large-scale movie productions. It reproduces a broad theater sound field that matches cinemascope and wider-screen movies with an excellent dynamic range providing everything from very small sound effects to large, impressive sounds. |
| Sci-Fi  | This program clearly reproduces the finely elaborated sound design of the latest science fiction and special effects-featuring movies. You can enjoy a variety of cinematographically created virtual spaces reproduced with clear separation between dialogue, sound effects and background music. |
| Adventure  | This program is ideal for precisely reproducing the sound design of action and adventure movies. The sound field restrains reverberations but puts emphasis on reproducing a powerful space expanded widely to the left and right. The reproduced depth is also restrained relatively to ensure the separation between audio channels and the clarity of the sound. |
| Drama  | This sound field features stable reverberations that match a wide range of movie genres from serious dramas to musicals and comedies. The reverberations are modest but offer an optimum 3D feeling, reproducing effects tones and background music softly but cubically around clear words and center positioning in a way that does not fatigue the listener even after long hours of viewing. |
| Mono Movie  | This program is provided for reproducing monaural video sources such as a classic movie in an atmosphere of a good old movie theater. The program produces the optimum expansion and reverberation to the original audio to create a comfortable space with a certain sound depth. |







Category: STEREO

Sound programs are optimized for listening to stereo sources.

| | |
|--|--|
| 2ch Stereo | Use this program to mix down multi-channel sources to 2-channels. When multi-channel signals are input, they are down mixed to 2-channels and output from the front left and right speakers. |
| 7ch Stereo  | Use this program to output sound from all speakers. When you playback multi-channel sources, this unit down-mixes the source to 2-channels, and then outputs the sound from all speakers. This program creates a larger sound field and is ideal for background music at parties, etc. |

Category: SUR.DECODE (Surround decode mode)

Select this program to playback sources with selected decoders. You can playback 2-channel audio sources in up to 7-channels using a surround decoder.

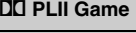
| | |
|---|---|
|  Pro Logic | Reproduces sound using the Dolby Pro Logic decoder. This is suitable for all kinds of audio sources. |
|  PLIIX Movie /  PLII Movie | Reproduces sound using the Dolby Pro Logic IIx (or Dolby Pro Logic II) decoder. This is suitable for movies. 🌱1 |
|  PLIIX Music /  PLII Music | Reproduces sound using the Dolby Pro Logic IIx (or Dolby Pro Logic II) decoder. This is suitable for music. 🌱1 |
|  PLIIX Game /  PLII Game | Reproduces sound using the Dolby Pro Logic IIx (or Dolby Pro Logic II) decoder. This is suitable for games. 🌱1 |
| Neo:6 Cinema | Reproduces sound using the DTS Neo:6 decoder. This is suitable for movies. |
| Neo:6 Music | Reproduces sound using the DTS Neo:6 decoder. This is suitable for music. |

🌱 1 : You cannot select the Dolby Pro Logic IIx decoder in the following conditions:

- When "Surround Back" is set to "None" (see p. 98).
- When headphones are connected.

Using the TV display to control this unit

This unit features a sophisticated on-screen display (OSD) that helps you to control the amplifier function of this unit. With the OSD, you can view information of the signals being input and the status of this unit. Visual guidance simplifies operations for menus.

Basic operations via the TV screen display

A TV screen is required to display the ON SCREEN or Option menu. Refer to “Connecting a TV monitor” for instructions on connecting a TV screen ([p. 29](#)).

This section describes basic operations for configuring “Input,” “Scene” and “Sound Program” using the OSD.

Press **8** ON SCREEN.

The ON SCREEN menu is displayed on the TV screen.

Selecting an input source

1 Use **9** Cursor Δ / ∇ to select “Input” and press **9** ENTER.

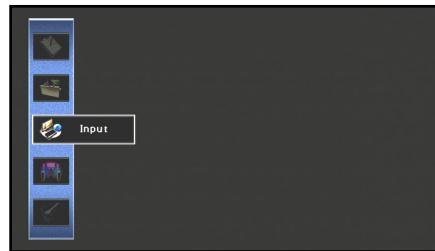

Input source icons are displayed at the bottom of the TV screen.

2 Use **9** Cursor $\triangleleft / \triangleright$ to select a Input source and press **9** ENTER.

The input source is selected.



- Pressing **9** RETURN displays the previous menu screen. Press **9** RETURN repeatedly to close the ON SCREEN menu.
- In addition to selecting an input source, detailed settings for each input source can be configured. Refer to “Configuring input sources (Input menu)” ([p. 84](#)) for details.

Selecting a scene

1 Use **9** Cursor Δ / ∇ to select “Scene” and press **9** ENTER.

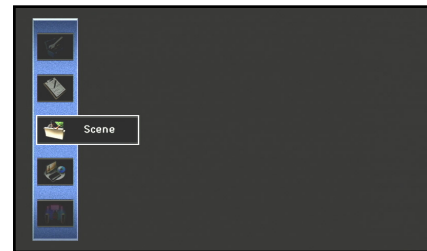

Scene icons are displayed at the bottom of the TV screen.

2 Use **9** Cursor $\triangleleft / \triangleright$ to select a scene and press **9** ENTER.

The scene is selected.



- Pressing **9** RETURN displays the previous menu screen. Press **9** RETURN repeatedly to close the ON SCREEN menu.
- Refer to “Changing input settings with a single key (SCENE function)” ([p. 53](#)) for details on the default scene settings.
- Detailed SCENE function settings can be edited. Refer to “Editing the SCENE function (Scene menu)” ([p. 87](#)) for details.

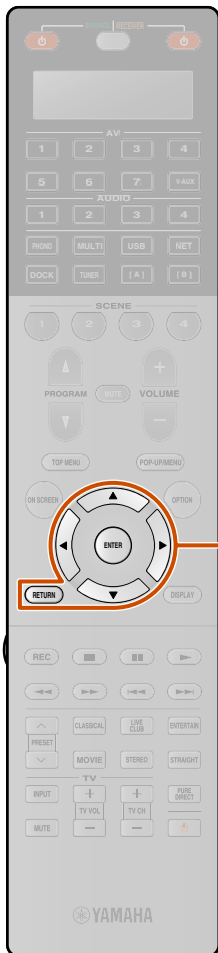

Selecting a sound program

- 1 Use **[ENTER]** Cursor Δ / ∇ to select “Sound Program” and press **[ENTER]**.

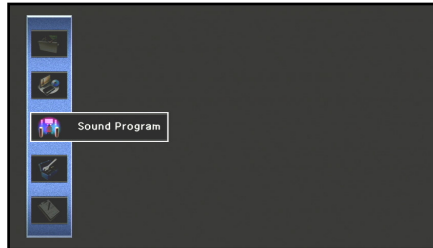

Sound program icons are displayed at the bottom of the TV screen.

- 2 Use **[ENTER]** Cursor \leftarrow / \rightarrow to select a sound program and press **[ENTER]**.

The sound program is selected.

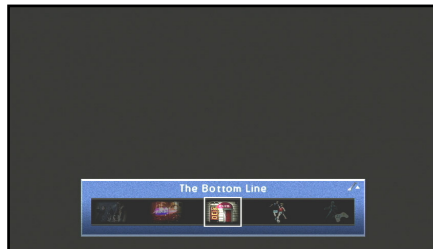

- Pressing **[RETURN]** displays the previous menu screen. Press **[RETURN]** repeatedly to close the ON SCREEN menu.
- Refer to “Enjoying favorite sound field effect” ([p. 54](#)) for various sound programs.
- You can configure the detailed settings for each sound program. Refer to “Setting sound program parameters (Sound Program menu)” ([p. 90](#)) for details.

NOTES

Menus can be operated and the status of this unit confirmed from the following three main displays.

- **ON SCREEN menu** ([p. 84](#))
- **Option menu** ([p. 61](#))
- **Content window** ([p. 65](#))

These menus and status features can be used to configure more various functions in addition to selecting “Input,” “Scene” and “Sound Program.” Refer to each references for details on menus and status.

Configuring settings specific to an individual input source (Option menu)

This unit has a unique Option menu for each input source. Option menus can be used to enable features such as volume trim for compatible input sources or to display audio/video data.

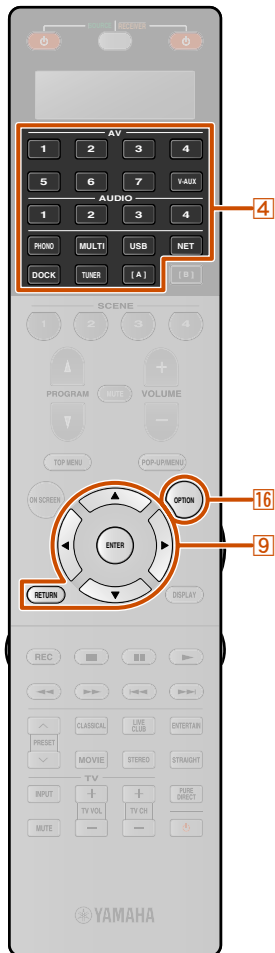

Option menu display and setup

Option menu operations are displayed on the front panel display or TV screen. TV display is used here to explain operation.

1 Use **[4] Input selector** to select an input source to which options will be applied.

2 Press **[16] OPTION**.
The Option menu is displayed.

Option menu

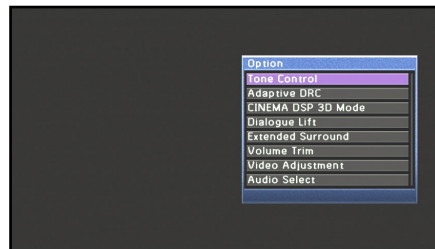

The displayed Option menu settings differ depending on the input source.

For more information, refer to the “Option menu” on the next page.

3 Use **[9] Cursor Δ / ∇** to select the desired setting and press **[9] ENTER**.

Parameters of the selected item are displayed.

4 Use **[9] Cursor \leftarrow / \rightarrow** to select the desired item (or enable a function).

- Press **[9] RETURN** to display the previous screen or close the Option menu.
- The Option menu may close automatically when some functions are enabled.

5 Press **[16] OPTION** to close the Option menu.

The keys on the remote control may not respond for a few seconds after the Option menu is closed. Should this occur, select the input source again.

Option menu

The following items are provided for each input source. “✓” indicates the available menu for each input source. 🧑‍🔧1

| | AV1-4 | AV5-7 | V-AUX | AUDIO1-4 | PHONO | MULTI CH | USB | PC | NET RADIO | DOCK (iPod) | DOCK (Bluetooth) | TUNER |
|--------------------|-------|-------|-------|----------|--------|----------|-----|----|-----------|-------------|------------------|-------|
| Tone Control | ✓ | ✓ | ✓ | ✓ | ✓ | | ✓ | ✓ | ✓ | ✓ | ✓ | ✓ |
| Adaptive DRC | ✓ | ✓ | ✓ | ✓ | ✓ | | ✓ | ✓ | ✓ | ✓ | ✓ | ✓ |
| CINEMA DSP 3D Mode | ✓ | ✓ | ✓ | ✓ | ✓ | | ✓ | ✓ | ✓ | ✓ | ✓ | ✓ |
| Dialogue Lift 🧑‍🔧2 | ✓ | ✓ | ✓ | ✓ | ✓ | | ✓ | ✓ | ✓ | ✓ | ✓ | ✓ |
| Extended Surround | ✓ | ✓ | ✓ | ✓ 🧑‍🔧3 | | | | | | | | |
| Volume Trim | ✓ | ✓ | ✓ | ✓ | ✓ | ✓ | ✓ | ✓ | ✓ | ✓ | ✓ | ✓ |
| Video Adjustment | ✓ | | ✓ | ✓ 🧑‍🔧4 | ✓ 🧑‍🔧4 | | | | | | | |
| Audio Select | ✓ | | ✓ | ✓ 🧑‍🔧3 | ✓ 🧑‍🔧3 | | | | | | | |
| Shuffle | | | | | | | ✓ | ✓ | | ✓ 🧑‍🔧5 | | |
| Repeat | | | | | | | ✓ | ✓ | | ✓ 🧑‍🔧5 | | |
| Connect | | | | | | | | | | | ✓ | |
| Disconnect | | | | | | | | | | | ✓ | |
| Pairing | | | | | | | | | | | ✓ | |

🧑‍🔧1 : When “Tone Control,” “Adaptive DRC,” “CINEMA DSP 3D Mode,” “Dialogue Lift,” or “Extended Surround” is adjusted for an input source, the same value is applied to other input sources and “ALL” is displayed on the front panel display. When settings specific to a certain input source are selected, the input source name is displayed on the front panel display. If the name of the input source has been changed (☞p. 85), the original name of the

input source is displayed.

🧑‍🔧2 : “Dialogue Lift” can be adjusted only when the presence speakers are available.

🧑‍🔧3 : This function is only available when “Coax/Opt” is assigned to this input source from “Input Assignment” in the Setup menu. Refer to “Assigning component input and output jacks” (☞p. 110) for details.

🧑‍🔧4 : This function can be set only when “Component” is assigned to this input source from “Input Assignment” in the Setup menu. Refer to “Assigning component input and output jacks” (☞p. 110) for details.

🧑‍🔧5 : Not available for Yamaha Wireless System for iPod.



Adjusting high/low-frequency sound

Tone Control

You can adjust the balance of the high-frequency range (Treble) and low-frequency range (Bass) of sounds output from the front left and right speakers to obtain desired tone.

| | |
|-----------------------|--------------------|
| Adjustable range | -6.0 dB to +6.0 dB |
| Adjustment increments | 0.5 dB |

Auto-adjusting the sound level to make even low volumes more audible

Adaptive DRC

Adjusts the dynamic range in conjunction with the volume level (from minimum to maximum). When this item is set to “On,” dialogue and sound effects are clearer. 🌟1

| | |
|---------------|--|
| Off (Default) | Does not adjust the dynamic range automatically. |
| On | Adjusts the dynamic range automatically. |

When “On” is selected, the dynamic range is adjusted as follows.

If the volume level is low, the dynamic range is narrow.
If the volume level is high, the dynamic range is wide.

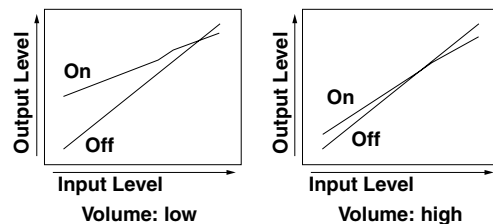

Enjoying more spatial sound fields

CINEMA DSP 3D Mode

When CINEMA DSP 3D is enabled, set whether to use sound programs in CINEMA DSP 3D mode (p. 55).

Adjusts the vertical position of dialogues

Dialogue Lift

Adjusts the vertical position of center sound such as dialogues when presence speakers are used. Increasing this parameter raises the position.

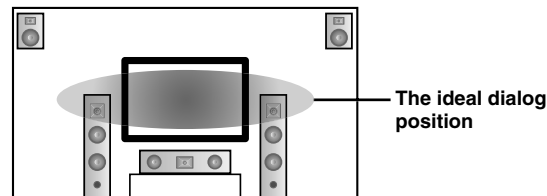

The ideal dialog position

If the dialog seems to come out from a lower position than the video monitor screen, increase this parameter.

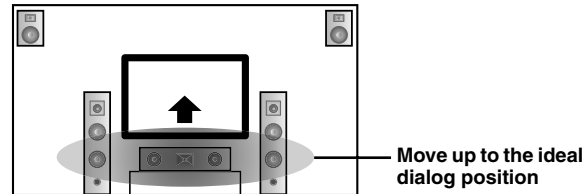

Move up to the ideal dialog position

“0” (default) corresponds to the lowest position and “5” to the highest position.

- “Dialogue Lift” can be adjusted only when the presence speakers are available.
- You cannot move the dialog position lower than the default setting.

Selecting the 5.1-channel signal playback method

Extended Surround

Selects whether to reproduce 5.1-channel input signals in 6.1- or 7.1-channel when surround back speakers are used. 🌟2

| | |
|---|--|
| Auto (Default) | Automatically selects the most suitable decoder if a flag for reproducing surround back channel is present, and reproduces the signals in 6.1- or 7.1-channel. |
| <input checked="" type="checkbox"/> PLIIx Movie | Always reproduces signals in 7.1-channel using the Dolby Pro Logic IIx Movie decoder whether or not surround back channel signals are contained. You can select this parameter when two surround back speakers are connected. |
| <input checked="" type="checkbox"/> PLIIx Music | Always reproduces signals in 6.1- or 7.1-channel using the Dolby Pro Logic IIx Music decoder whether or not surround back channel signals are contained. You can select this parameter when one or two surround back speakers are connected. |
| EX/ES | Automatically selects the most suitable decoder for input signals whether or not the flag for reproducing surround back channel is present, and always reproduces signals in 6.1-channel. |
| Off | Always reproduces original channels whether or not the flag for reproducing surround back channel is present. |

🌟1: “Adaptive DRC” is also effective when you use headphones.

🌟2: AV5-6 or AUDIO1-2 are available when “Audio Return Channel” is on, and the input source is used for “TV Audio Input.”

Adjusting volume between input sources

Volume Trim

Reduces any change in volume when switching between input sources by correcting volume differences in each input source. You can adjust this parameter for each input source.

| | |
|-----------------------|--------------------|
| Adjustable range | -6.0 dB to +6.0 dB |
| Default setting | 0.0 dB |
| Adjustment increments | 0.5 dB steps |

Selecting a video adjustment preset

Video Adjustment

Selects the desired “Adjustment” ([p. 103](#)) preset to be applied to the selected input source.

Selecting audio input jacks



Audio Select



Select the audio input jack through which source signal is input when an input source is connected to more than one jack.

| | |
|----------------|---|
| Auto (Default) | Automatically selects input signal in the following order: (1) HDMI (2) Digital signal (3) Analog signal |
| HDMI | Selects only HDMI signal. When no HDMI signal is input, no sound is output. |
| Coax/Opt | Selects only coaxial or optical signal. When no signal is input, no sound is output. |
| Analog | Selects only analog signal. If no analog signal is input, no sound is output. |

Shuffle playback



Shuffle

Plays back songs or albums in random order. When the shuffle function is enabled, “” appears on the TV screen. 

| | |
|--|-------------------------------------|
| Off | The shuffle function is turned off. |
| On  | The shuffle function is turned on. |
| Songs  | Plays songs back in random order. |
| Albums  | Plays albums back in random order. |

Repeat playback

Repeat

Plays songs or albums repeatedly. When the repeat function is enabled, “ (Single / One[iPod])” or “ (All)” appears on the TV screen. 

| | |
|--------------------|--|
| Off | The repeat function is turned off. |
| Single / One[iPod] | Plays a song back repeatedly. |
| All | When all songs have completed playback, returns to the start and repeats playback. |

Connect / Disconnect Bluetooth component

Connect

Disconnect

Switches communication with a Bluetooth component on and off ([p. 80](#)).

Pairing Bluetooth component

Pairing

Performs pairing of this unit and a Bluetooth component ([p. 80](#)).

 1: Not available for Yamaha Wireless System for iPod.

 2: This item is displayed only when PC or USB is selected as input source.

 3: This item is displayed only when DOCK (iPod) is selected as input source.

Confirming and operating input sources from the content window

When USB, NET, DOCK or TUNER is selected, the content window is displayed on the TV screen. Playback style for iPod, functions for FM/AM tuner, Internet Radio, PC, and USB can be set in the content window.

A TV screen is required to display the content window. Refer to “Connecting a TV monitor” for instructions on connecting a TV monitor (p. 29).

Displaying the content window on the TV screen

Press **4**USB, **4**NET, **4**DOCK or **4**TUNER to display the content window.

The content window consists of two main displays, the Now Playing view and the Browse view.

Below is the example of the Now Playing view for DOCK (iPod).

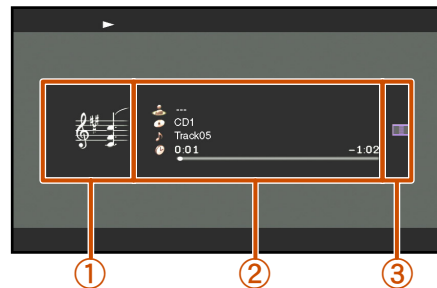
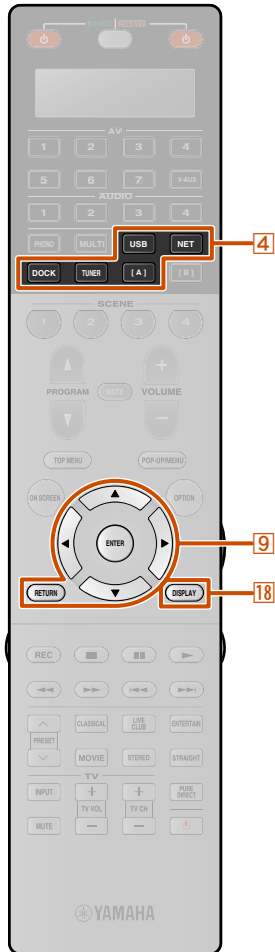

- ① **Image display**
Icon for each input source or album art is displayed.
- ② **Information display**
Information on the current input source is displayed.

③ Screen button area

Buttons to operate each input source are displayed here. These buttons vary depending on the selected input. For details on operations for each input, see the following.

- FM/AM stations (p. 67)
- PC servers (p. 70)
- USB storage (p. 72)
- Internet Radio (p. 74)
- iPod (p. 77)

- In the Now Playing view, press **9**ENTER and use **9**Cursor Δ / ∇ to select a button. Then press **9**ENTER to execute the selection.
- In the Browse view, press **9**Cursor \triangleright and use **9**Cursor Δ / ∇ to select a button. Then press **9**ENTER to execute the selection.
- Press **9**RETURN repeatedly to exit from the operation.

Switching the display between the Now Playing view and the Browse view

You can switch the display between the Now Playing view and the Browse view by the following methods.

- Press **18**DISPLAY to cycle between the Now Playing view and the Browse view.
- In the Now Playing view, press **9**ENTER and use **9**Cursor Δ / ∇ to select the icon. Then press **9**ENTER to switch to the Browse view.
- In the Browse view, press **9**Cursor \triangleright and use **9**Cursor Δ / ∇ to select the icon. Then press **9**ENTER to switch to the Now Playing view.

Browse view



Now Playing view

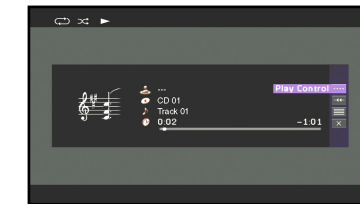

When selecting “DOCK (iPod)” as input source and playing back video content of iPod/iPhone, the screen switches as follows by pressing **18**DISPLAY repeatedly.

Now Playing view → Browse view →
Video playback screen (content window disappears)
→ Now Playing view

FM/AM tuning

When using the FM/AM tuner, adjust the direction of the FM/AM antenna connected to this unit to get the best reception.

Selecting a frequency for reception (Normal tuning)

- 1 Press **[4] TUNER** to switch to the tuner input.
- 2 Press **[25] FM** or **[25] AM** to select a band to receive.



- 3 Use **[25] TUN./CH** \wedge / \vee to set a frequency to receive.

[25] TUN./CH \wedge

Increases the frequency. Press and hold this key for longer than a second to search automatically for a station on a higher frequency than the current one. 1

[25] TUN./CH \vee

Decreases the frequency. Press and hold this key for longer than a second to search automatically for a station on a lower frequency than the current one. 1

Lights up when a broadcast is received from a station



Lights up when a stereo broadcast is received

Entering a frequency number

In normal tuning mode, use the **[22] Numeric keys** to enter a frequency. Leave the decimal point out when entering a number. 2

For example, enter as follows to select a station on 98.50 MHz.

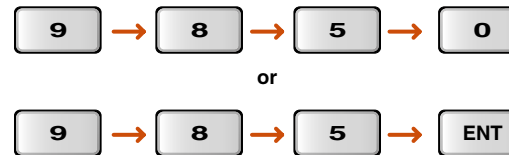

Registering stations manually (Manual Preset)

Select stations manually and register them as presets individually.

- 1 Tune in to the station you want to register, referring to “Selecting a frequency for reception (Normal tuning).”

- 2 Use one of the following methods to register the station you are currently receiving.

Registering to a preset number to which no station is registered

Press **[25] MEMORY** for 3 seconds or longer.

The station will be registered automatically to the lowest open preset number (or the next number after the one registered most recently).

Registered frequencies



Continues to the next page

1 : When searching for a station, release the key once the search has started.

2 : “Wrong Station!” appears on the front panel display when you enter a frequency that is out of receivable range. Make sure that the frequency entered is correct.

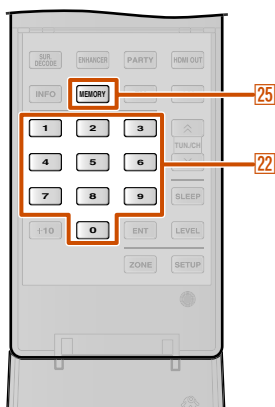
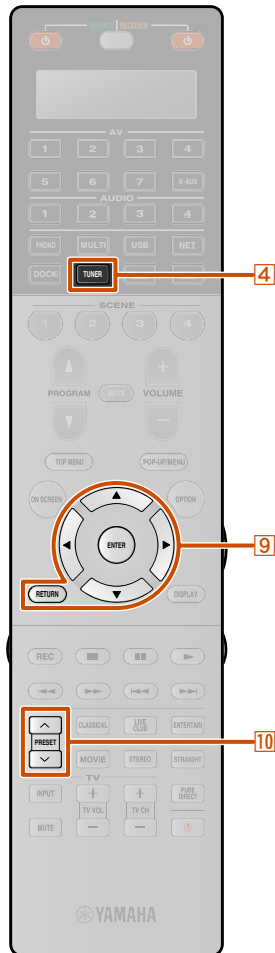

■ Designating a preset number for registration

Press **25**MEMORY once, to display “Manual Preset” on the front panel display. After a small wait, the preset number that the station has been registered to will appear. 🌟1

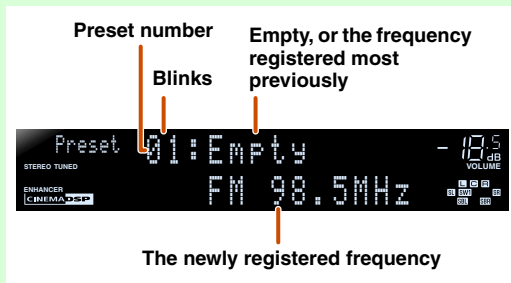

Press **10**PRESET ^ / v to select the preset number to register the station to, and then press **25**MEMORY to register.

To select a registered station, press **10**PRESET ^ / v to select the preset number of the station. 🌟2

Navigating the FM/AM tuner from the content window

The station currently received can be confirmed from the menu displayed on the TV screen. Various FM/AM tuner operations can be performed from the content window rather than controls on the front panel display. The content window is displayed when **4**TUNER is pressed.

You can operate the FM/AM tuner from the Now Playing view or the Browse view.

■ Operating from the Now Playing view

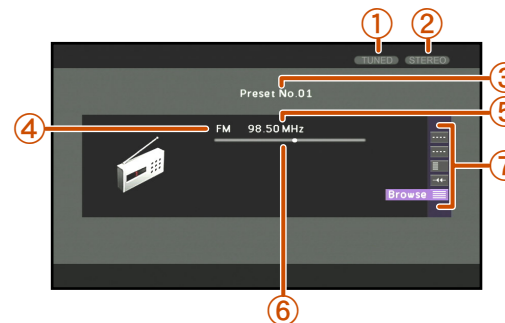

- ① **Tuned indicator**
Lights up when a station is received.
- ② **Stereo indicator**
Lights up when a stereo broadcast is received. When “FM Mode” is set to “Mono,” the indicator does not light.
- ③ **Preset number**
The selected preset number is displayed.
- ④ **Band**
The selected band (FM or AM) is displayed.
- ⑤ **Frequency**
The frequency currently received is displayed.

- ⑥ **Frequency guide**
The frequency currently received is displayed as a cursor on the bar.
- ⑦ **Screen button area**
Buttons for available operations are displayed. See “Screen buttons on the Now Playing view” for details.

Screen buttons on the Now Playing view

To use these buttons, first press **9**ENTER. Then select the desired one with **9**Cursor Δ / ▽ and **9**ENTER.

Manual Tuning

You can tune in to a desired FM/AM station by specifying its frequency.

| | |
|----------|--|
| FM | Switches a band to FM. |
| AM | Switches a band to AM. |
| Tuning - | Decreases the frequency. |
| Tuning + | Increases the frequency. |
| Auto - | Automatically searches for a station on a lower frequency than the current station. |
| Auto + | Automatically searches for a station on a higher frequency than the current station. |
| Direct | Selects the frequency manually. |
| Memory | Registers the station currently received as a preset station. Up to 40 FM/AM stations can be registered. |

🌟1 : Press **9**RETURN or wait with no operation for 30 seconds to exit the Manual Preset mode.

🌟2 : To select a station by selecting a preset number, use the **22**Numeric keys to enter the preset number of the station you want to listen. When an invalid number is entered, “Wrong Num.” appears on the front panel display. Check that you have entered the correct number.



Preset Select

You can call preset stations.

| | |
|-----------|--|
| Preset - | Selects the previous preset number. |
| Preset + | Selects the next preset number. |
| Preset -8 | Returns the previous page. |
| Preset +8 | Goes to the next page. |
| Memory | Registers the station currently received as a preset station. Up to 40 FM/AM stations can be registered. |
| Direct | Selects a station directly by entering the preset number. |

Utility

| | |
|---------|---|
| FM Mode | Selects "Stereo" or "Mono" when receiving the FM station (see p. 66). |
|---------|---|

Scroll

Switches the scroll target.

Browse

Switches the display to the Browse view.

Operating from the Browse view

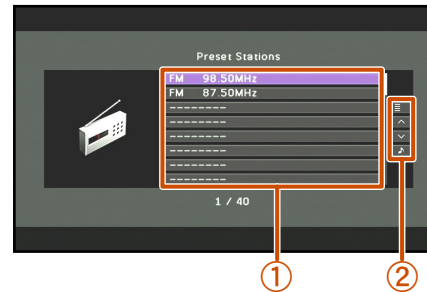

- 1 Preset station list**
The list of preset stations is displayed.
- 2 Screen button area**
Buttons for available operations are displayed. See "Screen buttons on the Browse view" for details.

Screen buttons on the Browse view

To use these buttons, first press **9**Cursor **▷**. Then select the desired one with **9**Cursor **△ / ▽** and **9**ENTER.

Utility

| | |
|------------------|--|
| Auto Preset | Detects FM stations with a strong signal and automatically registers up to 40 FM stations, beginning with the next number after the current number (see p. 68). AM stations cannot be registered by using "Auto Preset." |
| Clear Preset | Clears registration of the preset station highlighted in the preset station list. |
| Clear All Preset | Clears registration of all preset stations. |

1 Page Up

1 Page Down

Scrolls the list to the next or previous page.

Now Playing

Switches the display to the Now Playing view.

Playing back tunes on the PC

You can enjoy playback of audio files stored on PCs connected to this unit via your network. To play back audio files on your PC, you need to install Windows Media Player on the PC and configure the media sharing setting of Windows Media Player.

If you do not use a DHCP server, configure the network parameters (IP address, etc.) of this unit manually ([p. 106](#)).

Windows Media Player setup

1 Install Windows Media Player on your PC.

You can download the installer of Windows Media Player from the Microsoft website, or use the upgrade function of the installed Microsoft Windows Media Player.

2 Turn on your PC then allow media sharing.

Activate Windows Media Player first, enable the media sharing and then select this unit as a device to which the media is shared.

NOTES

- Some security software installed on your PC (anti-virus software, firewall software, etc.) may block the access of this unit to your PC. In such cases, configure the security software appropriately.
- You can connect this unit to up to 16 PC servers, and each server must be connected to the same subnet as this unit.

Playback of PC music contents

For a complete list of status messages that appear on the front panel display and GUI screen, see “USB and Network” ([p. 141](#)).

The PC music contents can be operated from the menu displayed on the TV screen.

You can operate the PC contents from the Now Playing view or the Browse view.

Operating from the Browse view

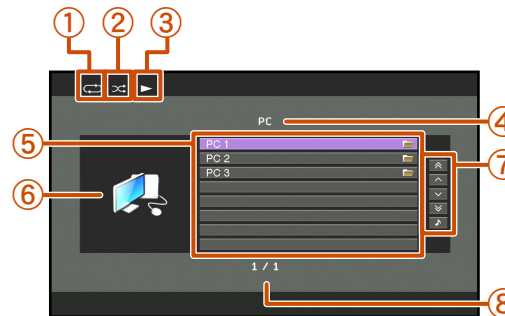

- ① Repeat icon
- ② Shuffle icon
- ③ Play icon
- ④ Current directory name
- ⑤ Menu items
- ⑥ Album art / Input icon
- ⑦ Screen button area
Buttons for available operations are displayed. See “Screen buttons on the Browse view” for details.
- ⑧ Current menu number / Number of all menu items

Screen buttons on the Browse view

To use these buttons, first press **[9]Cursor ▷**. Then select the desired one with **[9]Cursor △ / ▽** and **[9]ENTER**.

10 Pages Up

10 Pages Down

Goes to 10 pages forwards or backwards.

1 Page Up

1 Page Down

Scrolls the list to the next or previous page.

Now Playing

Switches the display to the Now Playing view.

1 Press **[4]NET** repeatedly to select “PC” as the input source.

2 Press **[9]Cursor △ / ▽** to select a PC server and music file to play back.

- To select a PC server, folder or file, press **[9]Cursor △ / ▽**.
- To confirm the selection, press **[9]ENTER**.
- To return to the previous menu, press **[9]RETURN**.

3 Press **[9]ENTER** to start playback.
The Now Playing view appears during playback.



Operating from the Now Playing view

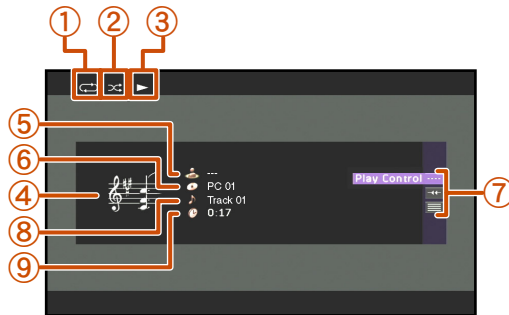

- ① Repeat icon
- ② Shuffle icon
- ③ Play icon
- ④ Album image
- ⑤ Artist name
- ⑥ Album title
- ⑦ Screen button area
- ⑧ Song title
- ⑨ Elapsed time

- You can switch the information displayed on the front panel display by pressing **[21]INFO** (see p. 11).
- Album images are available only when the file contains image data.

Screen buttons on the Now Playing view

To use these buttons, first press **[9]ENTER**. Then select the desired one with **[9]Cursor Δ / ▽** and **[9]ENTER**.



Play Control

Operates the basic playback functions of PC.

| | | |
|--|----------|--|
| | (Play) | Starts playback. |
| | (Stop) | Stops playback. |
| | (Pause) | Stops playback temporarily. |
| | (Skip -) | Skips to the beginning of the currently playing song. Press [9]ENTER at the beginning of the song to skip to a previous song. |
| | (Skip +) | Skips to the beginning of the next song. |

Scroll

Switches the scroll target (artist name, album title, or song title).

Browse

Switches the display to the Browse view.

Compatibility of Digital Media Controller

A DLNA-compliant Digital Media Controller (DMC) device can also be used to control music playback. Refer to “Using a PC to control this unit over a network” (see p. 86) for details.

CAUTION

When DMC controls are used to adjust volume, playback volume may be unexpectedly loud. This could result in damage to this unit or the speakers. “Max Volume” can be used to specify the maximum volume level to prevent excessively loud playback (see p. 101).

Operating basic playback functions with the remote control

Use the following remote control keys to operate (playback, stop, skip, etc.) your PC contents.

| | |
|--|--------------------------------------|
| | Play |
| | Stop |
| | Switches between playback and pause. |
| | Skip forward during playback |
| | Skip backward during playback |

Shuffle/repeat playback

Use the Option menu to apply playback shuffle and repeat settings. Refer to “Shuffle playback” (see p. 64) and “Repeat playback” (see p. 64) for details.

- 1**: A shortcut button cannot be registered when a DMC is used.
- 2**: Set “DMC Control” to “Disable” to automatically play back the last song played when this unit is turned on.

Playing back tunes on the USB storage devices

You can enjoy playback of WAV (PCM format only), MP3, WMA, MPEG-4 AAC and FLAC files stored on your USB memory device or USB portable player connected to the USB port on the front panel of this unit. This unit supports USB mass storage class devices (FAT 16 or FAT 32 format, except USB HDDs).

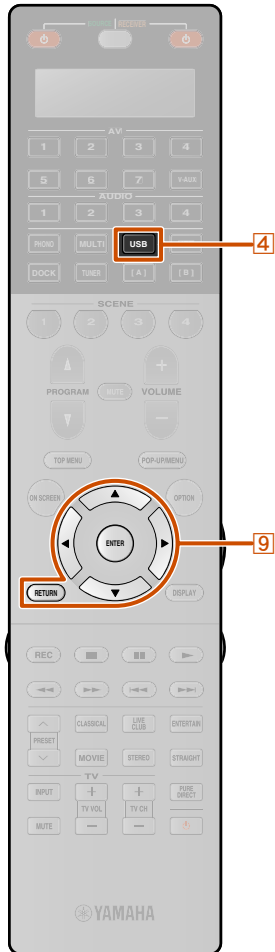

- You can play back only the files stored in the first partition.
- Some files may not be playable depending on models and types of USB storage devices.
- For a complete list of status messages that appear on the front panel display and GUI screen, see “USB and Network” (p. 141).
- This unit is compatible with sampling frequency of up to 48 kHz for the USB storage device.

Playback of the USB storage device

The USB storage device can be operated from the menu displayed on the TV screen.

You can operate the contents of USB storage device from the Now Playing view or the Browse view.

Operating from the Browse view

If you have connected the USB storage device to this unit before, playback of the music file played at the last time automatically starts.

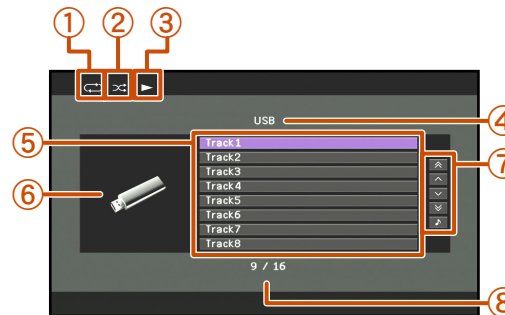

- 1 Repeat icon
- 2 Shuffle icon
- 3 Play icon
- 4 Current directory name
- 5 Menu items
- 6 Input icon
- 7 Screen button area
Buttons for available operations are displayed. See “Screen buttons on the Browse view” for details.
- 8 Current menu number / Number of all menu items

Screen buttons on the Browse view

To use these buttons, first press [9]Cursor ▷. Then select the desired one with [9]Cursor △ / ▽ and [9]ENTER.

10 Pages Up

10 Pages Down

Goes to 10 pages forwards or backwards.

1 Page Up

1 Page Down

Scrolls the list to the next or previous page.

Now Playing

Switches the display to the Now Playing view.

1 Connect your USB storage device to the USB port on the front panel (p. 40).

2 Rotate the INPUT selector (or press [4]USB) to select “USB” as the input source.

3 Press [9]Cursor △ / ▽ / ◀ / ▶ to select a music file to play back.

- To select a file or folder, press [9]Cursor △ / ▽.
- To confirm the selection, press [9]ENTER.
- To return to the previous menu, press [9]RETURN.

4 Press [9]ENTER to start playback.
The Now Playing view appears during playback.



Operating from the Now Playing view

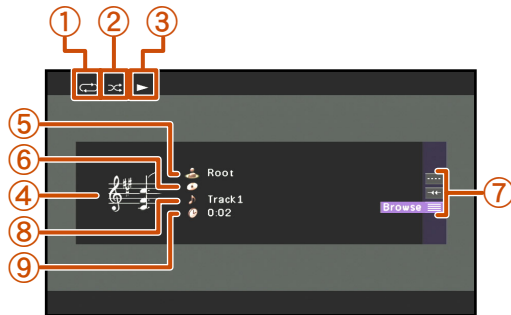

- ① Repeat icon
- ② Shuffle icon
- ③ Play icon
- ④ Album image
- ⑤ Artist name
- ⑥ Album title
- ⑦ Screen button area
- ⑧ Song title
- ⑨ Elapsed time

- You can switch the information displayed on the front panel display by pressing **[21]INFO** (see p. 11).
- Album images are available only when the file contains image data.

Screen buttons on the Now Playing view

To use these buttons, first press **[9]ENTER**. Then select the desired one with **[9]Cursor Δ / ▽** and **[9]ENTER**.

Play Control

Operates the basic playback functions of USB.

| | |
|----------|--|
| (Stop) | Stops playback. |
| (Skip -) | Skips to the beginning of the currently playing song. Press [9]ENTER at the beginning of the song to skip to a previous song. |
| (Skip +) | Skips to the beginning of the next song. |

Scroll

Switches the scroll target (artist name, album title, or song title).

Browse

Switches the display to the Browse view.

Operating basic playback functions with the remote control

Use the following remote control keys to operate (playback, stop, skip, etc.) USB storage device.

| | |
|-----|-------------------------------|
| [7] | Play |
| [7] | Stop |
| [7] | Skip forward during playback |
| [7] | Skip backward during playback |

Shuffle/repeat playback

Use the Option menu to apply playback shuffle and repeat settings. Refer to “Shuffle playback” (see p. 64) and “Repeat playback” (see p. 64) for details.

Listening to the Internet Radio

You can listen to Internet Radio stations using the vTuner Internet Radio station database service particularly customized for this unit, providing a database of over 2000 radio stations. Also, you can store your favorite stations with bookmarks.

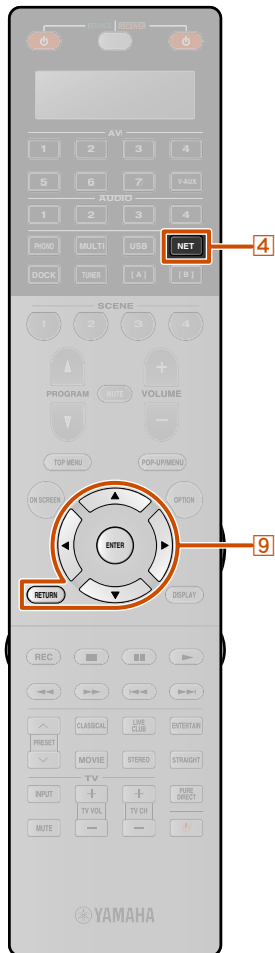

- To use this feature, your network must be connected to the Internet.
- A narrowband Internet connection (i.e. 56K modem, ISDN) will not provide satisfactory results, and a broadband connection is strongly recommended (i.e. a cable modem, an xDSL modem, etc.). For detailed information, consult with your ISP.
- If you do not use a DHCP server, configure the network parameters (IP address, etc.) of this unit manually ([p. 106](#)).
- Some security devices (such as firewall) may block the access of this unit to Internet Radio stations. In such cases, configure the security settings appropriately.
- This service may be discontinued without notice.
- Some Internet Radio stations may not be played.

Listening to Internet Radio

For a complete list of status messages that appear on the front panel display and GUI screen, see “USB and Network” ([p. 141](#)).

The Internet Radio can be operated from the menu displayed on the TV screen.

You can operate the Internet Radio from the Now Playing view or the Browse view.

Operating from the Browse view

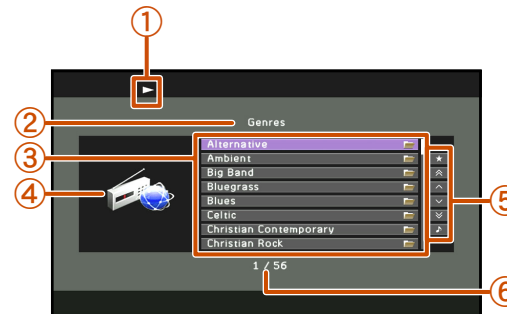

- 1 **Play icon**
- 2 **Current directory name**
- 3 **Menu items**
- 4 **Album art / Input icon**
- 5 **Screen button area**
Buttons for available operations are displayed. See “Screen buttons on the Browse view” for details.
- 6 **Current menu number / Number of all menu items**

Screen buttons on the Browse view

To use these buttons, first press **[9]Cursor >**. Then select the desired one with **[9]Cursor Δ / ▽** and **[9]ENTER**.

Bookmark On

The selected Internet Radio station is added to the Bookmarks list in “NET RADIO.”

Bookmark Off

This item is displayed in the bookmark directory. The selected Internet Radio station is removed from the Bookmarks list.

10 Pages Up

10 Pages Down

Goes to 10 pages forwards or backwards.

1 Page Up

1 Page Down

Scrolls the list to the next or previous page.

Now Playing

Switches the display to the Now Playing view.

1 Press [4]NET repeatedly to select “NET RADIO” as the input source.

2 Press [9]Cursor Δ / ▽ to select an item to play back.

- To select an item, press **[9]Cursor Δ / ▽**.
- To confirm the selection, press **[9]ENTER**.
- To return to the previous menu, press **[9]RETURN**.

3 Press [9]ENTER to start playback.

The Now Playing view appears during playback.

Operating from the Now Playing view

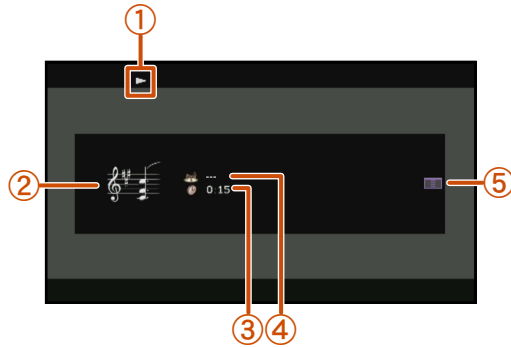

- ① Play icon
- ② Album image
- ③ Elapsed time
- ④ Current station name
- ⑤ Screen button area

Buttons for available operations are displayed. See “Screen buttons on the Now Playing view” for details.

You can switch the information displayed on the front panel display by pressing **[21]INFO** (p. 11).

Screen buttons on the Now Playing view

To use these buttons, first press **[9]ENTER**. Then select the desired one with **[9]Cursor Δ / ▽** and **[9]ENTER**.

Bookmark On

The station currently being played back is added to the Bookmarks list in “NET RADIO.”

Play Control

The following operation is available.

| | |
|--------|-----------------|
| (Stop) | Stops playback. |
|--------|-----------------|

Browse

Switches the display to the Browse view.

Operating basic playback functions with the remote control

Use the following remote control keys to operate (playback, stop) the Internet Radio.

| | |
|-----|------|
| [7] | Play |
| [7] | Stop |

You can also register your favorite Internet Radio stations on this unit by accessing the website with the web browser on your PC. To use this feature, you need the vTuner ID of this unit and your e-mail address to create your personal account. For details, refer to the help information on the website.
URL: <http://yradio.vtuner.com/>

NOTE

To clear the personal account such as vTuner ID or e-mail address, perform “NETWORK” of “INITIALIZE” in the Advanced Setup menu (p. 127).



Using shortcut function

Use this feature to access the desired music sources (WAV, MP3 and WMA files on the connected PC or USB storage devices and Internet Radio Stations) directly. You can preset up to 40 items for above input sources.

■ Assigning the items to the preset number

1 Select a desired content you want to assign to a preset number, and then play back the content.

2 Press **[25]MEMORY**.

This unit automatically selects an empty preset number and the following display appears.



Preset number (Blinks)

- To automatically assign the selected content to an empty preset number, press and hold **[25]MEMORY** for at least 2 seconds with step 2. In this case, the following steps are unnecessary.
- To cancel the preset, press **[9]RETURN**.
- When you do not complete each of the following steps within 30 seconds, the memory preset mode is automatically canceled. In this case, start over from step 2.

3 Press **[10]PRESET ^ / v** or **[22]Numeric keys** to select the preset number that you want to assign.



Valid numbers as the preset number are “01” to “40.”

4 Press **[25]MEMORY**.

The following display appears on the front panel display and the preset content is set.



■ Selecting the item assigned to the preset number

Press **[10]PRESET ^ / v** to select the preset number to which the desired item is assigned to select the item as the input source.

This unit starts the playback of the source assigned to the selected numeric button.

NOTES

- “xx:Empty” appears on the front panel display when you select the preset number to which no items are assigned.
- This unit does not recall the correct item assigned to the selected preset number in the following cases:
 - the connected USB device is incorrect.
 - the PC which stores the selected item is turned off or disconnected from the network.
 - the selected Internet Radio station is temporary unavailable or out of service.
 - the directory of the selected item has been changed.

This unit stores the relative position of the preset items in a directory or playlist, and does not recall the correct item by using **[22]Numeric keys** if you add or delete music files to or from the same directory or playlist as the preset items. In such cases, preset the desired item to the preset numbers again.

We recommend the following methods:

USB storage devices

Create several directories containing the desired content in a directory beside the directory containing all music files, and then assign the top item of each directory to a preset number. To change the content assigned to preset numbers, replace the content in the directory to new content without deleting the directory.

PC server

Create eight playlists containing the desired content, and then assign the top item of each playlist to a preset number. To change the content assigned to preset numbers, replace the content registered with a playlist with new content without deleting the playlist.

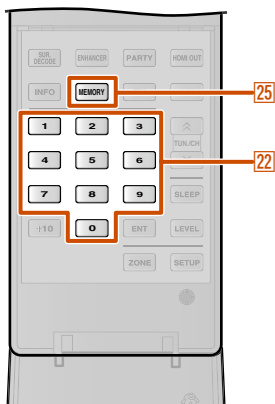

Playing back tunes from your iPod™/iPhone™

Once you have connected a Universal Dock for iPod (such as the YDS-12, sold separately) to this unit, you can enjoy playback of your iPod/iPhone using the remote control supplied with this unit. When playing back from an iPod/iPhone, you can also use the compressed music enhancer sound programs to give compressed audio formats such as MP3 a sharper, more dynamic sound ([esp. 56](#)). A Yamaha Wireless System for iPod (YID-W10, sold separately) can also be connected to this unit to play back iPod/iPhone with wireless connection.



- **When playing back iPod/iPhone with wired connection**

Refer to “Connecting the Universal Dock for iPod.”

- **When playing back iPod/iPhone with wireless connection**

Refer to “Playing iPod™/iPhone™ with wireless connection” ([esp. 78](#)).

Connecting the Universal Dock for iPod

Use the dedicated cable to connect the dock to the DOCK jack on the rear panel of this unit. Refer to the operating instructions of the Universal Dock for iPod for information on how to connect your iPod/iPhone.

- iPod touch, iPod (4th Gen/5th Gen/Classic), iPod nano, iPod mini, iPhone, iPhone 3G, and iPhone 3GS are supported (As of March 2010).
- When connecting iPhone, iPhone 3G and iPhone 3GS, use a YDS-12.
- Some features may not be compatible depending on the model or the software version of your iPod/iPhone.
- Some functions may not be available for some Universal Dock for iPod models. This explanation focuses on the YDS-12.

CAUTION

To prevent accidents, switch this unit to standby mode before connecting the Universal Dock for iPod.

Switch this unit on and place your iPod/iPhone in the dock. The unit is now ready for playback.

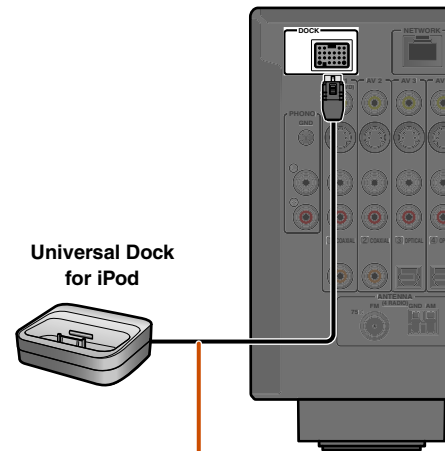

Locate the wireless dock at the distance as far as from the unit.

When this unit is in standby mode, iPod/iPhone can be charged automatically ([esp. 86](#)).

Controlling an iPod™/iPhone™

After setting your iPod/iPhone in your dock, just press **4 DOCK** to switch to DOCK input to play your iPod/iPhone.

The iPod/iPhone can be operated in the following two ways.

Menu browse control:

Plays the iPod/iPhone while viewing the menu displayed on the TV. Refer to “Playing iPod™/iPhone™ from the menu screen (Menu browse control)” ([esp. 77](#)).

Simple remote control:

Plays audio and video through this unit while viewing the menu displayed on the iPod/iPhone screen. Refer to “Operating basic playback functions via the remote control (Simple remote control)” ([esp. 78](#)).

- Song information (artist, album, song) is displayed on the front panel. Press **21 INFO** repeatedly to display subsequent/previous information when displaying Now Playing view in Menu browse control.
- The Yamaha logo is displayed on the iPod screen when iPod stationed in the Universal Dock for iPod (does not apply to the iPod touch or iPhone). However, the Yamaha logo is not displayed in Simple remote control.
- Manual control of the iPod/iPhone is not possible while the iPod stationed in the Universal Dock for iPod and Menu browse control is displayed.

Playing iPod™/iPhone™ from the menu screen (Menu browse control)

The iPod/iPhone can be operated from the menu displayed on the TV screen.

You can operate the iPod/iPhone from the Now Playing view or the Browse view.

Operating from the Browse view

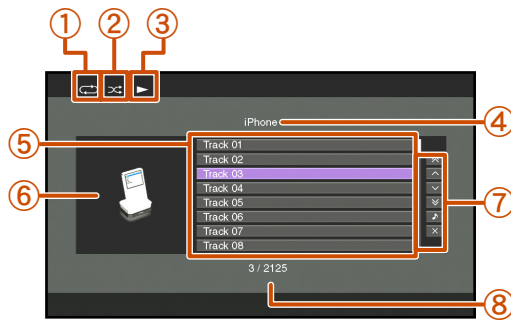
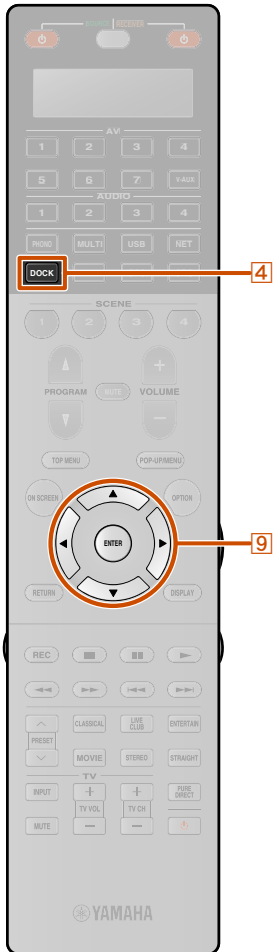

- ① Repeat icon
- ② Shuffle icon
- ③ Play icon
- ④ Current directory name
- ⑤ Menu items
- ⑥ Input icon
- ⑦ Screen button area
- Buttons for available operations are displayed. See “Screen buttons on the Browse view” for details.
- ⑧ Current menu number / Number of all menu items

Screen buttons on the Browse view

To use these buttons, first press [9]Cursor ▷. Then select the desired one with [9]Cursor △ / ▽ and [9]ENTER.

10 Pages Up

10 Pages Down

Goes to 10 pages forwards or backwards.

1 Page Up

1 Page Down

Scrolls the list to the next or previous page.

Now Playing

Switches the display to the Now Playing view.

Close

Returns to the video playback, turning off the menu display.

1 Press [4]DOCK to switch to the DOCK input.

2 Press [9]Cursor △ / ▽ to select the content (music or video) that you want to play, and press [9]ENTER. 🌱1

3 Press [9]Cursor △ / ▽ to select iPod/iPhone menu items, and press [9]ENTER to play.

The Now Playing view appears during playback. 🌱2

Operating from the Now Playing view

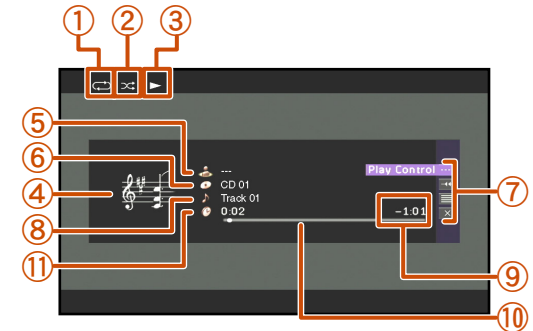

- ① Repeat icon
- ② Shuffle icon
- ③ Play icon
- ④ Album image
- ⑤ Artist name
- ⑥ Album title
- ⑦ Screen button area
- Buttons for available operations are displayed. See “Screen buttons on the Now Playing view” for details.
- ⑧ Song title
- ⑨ Remaining time
- ⑩ Progress bar
- ⑪ Elapsed time

🌱1 : Videos will not be displayed when your iPod or Universal Dock for iPod do not support the browser function for browsing video files.

🌱2 : When selecting the video content, the following display is not displayed.

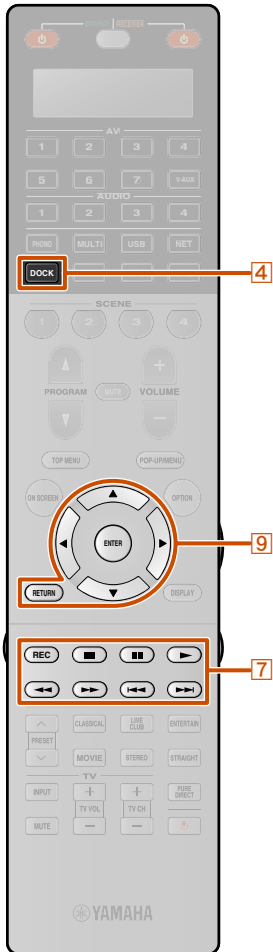

Screen buttons on the Now Playing view
To use these buttons, first press **[9]ENTER**. Then select the desired one with **[9]Cursor Δ / ▽** and **[9]ENTER**.

Play Control

Operates the basic playback functions of iPod/iPhone.

| | |
|----------------------|--|
| [▷] (Play) | Starts playback. |
| [◻] (Stop) | Stops playback. |
| [⏸] (Pause) | Stops playback temporarily. |
| [◀◀] (Skip -) | Skips to the beginning of the currently playing song. Press [9]ENTER at the beginning of the song to skip to a previous song. |
| [▶▶] (Skip +) | Skips to the beginning of the next song. |
| [◀◀] (Scan -) | Searches backwards. |
| [▶▶] (Scan +) | Searches forwards. |

Scroll

Switches the scroll target (artist name, album title, or song title).

Browse

Switches the display to the Browse view.

Close

Returns to the video playback, turning off the menu display.

Operating basic playback functions via the remote control (Simple remote control)

Use the following remote control keys to operate (playback, stop, skip, etc.) your iPod/iPhone. Press **[7]REC** to enable the Simple remote control. Press **[7]REC** again to return to the Menu browse control.

| | |
|------------------------|---|
| [4]DOCK | Switches to the DOCK (iPod) input. |
| [9]Cursor Δ / ▽ | Move the cursor up and down to different fields. |
| [9]RETURN | Returns to the previous menu. |
| [9]ENTER | Confirms the selected menu. |
| [7]◀◀ | Searches backwards while held down. |
| [7]▶▶ | Searches forwards while held down. |
| [7]◀◀ | Skips to the beginning of the currently playing song. Pressing repeatedly skips one song backwards with each press. |
| [7]▶▶ | Skips to the beginning of the next song. |
| [7]◻ | Stops playback. |
| [7]⏸ | Switches between playback and pause. |
| [7]▷ | Switches between playback and pause. |
| [7]REC | Switches the control method between the Menu browse control and Simple remote control. |

Playing iPod™/iPhone™ with wireless connection

A Wireless System for iPod (YID-W10, sold separately) can be connected to this unit to play back iPod/iPhone with wireless connection. The iPod/iPhone can be used as the remote control. 1

Connecting the Wireless System for iPod and playing back iPod/iPhone

Use the dedicated cable to connect the receiver of the Wireless System for iPod to the DOCK jack on the rear panel of this unit. Refer to the operating instructions of the YID-W10 for more information.

CAUTION

To prevent accidents, unplug the power cable of this unit before connecting the receiver of the Wireless System for iPod.

Continues to the next page

1 : Video signals cannot be transmitted wirelessly.

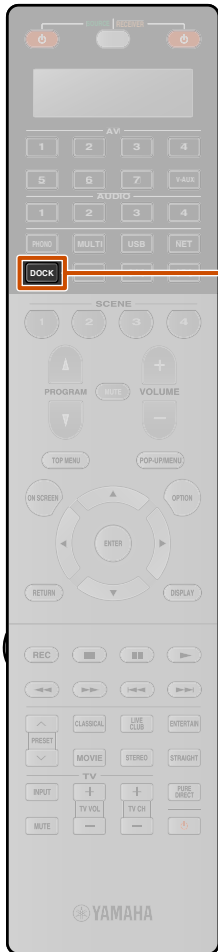

Place the iPod/iPhone in the wireless transmitter. Setup is complete.

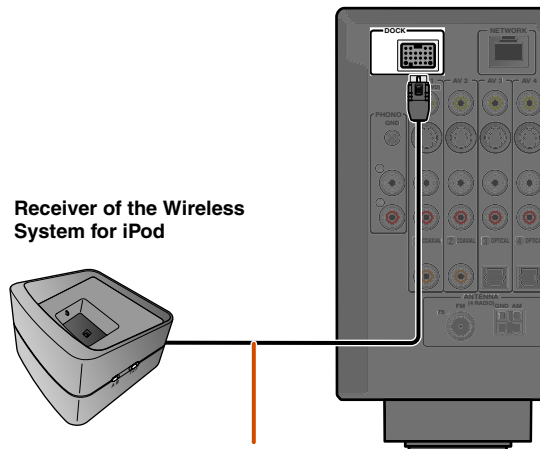

Position the receiver as far as possible from the unit.

When this unit is in standby mode, iPod/iPhone can be charged automatically, if “Standby Charge” is set to “Auto” ([p. 86](#)) or “Power & Input” of “iPod Interlock” is set to “On” ([p. 86](#)).

Use iPod/iPhone to start playback.

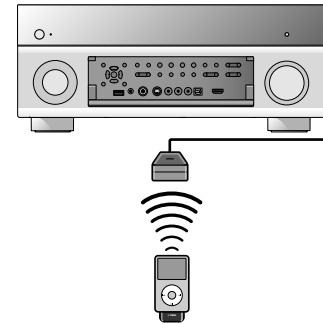

- This unit, which is placed in the main zone, functions as follows when iPod/iPhone controls are used to start playback.
 - The input source switches to DOCK (iPod) when this unit is turned on.
 - When this unit is in standby mode when iPod/iPhone playback starts, this unit turns on and the input source switches to DOCK (iPod). 📶 1
- This unit automatically enters standby mode when the following operations are performed.
 - iPod/iPhone is removed from the YID-W10
 - iPod/iPhone is not operated for a while after playback is stopped

- Pressing **4 DOCK** also switches the input source to DOCK (iPod).
- When a menu is operated, this function is not activated.
- When “iPod Interlock” → “Power & Input” in the Input menu is set to “Off,” the power and the input source do not switch automatically ([p. 86](#)).

- Adjusting volume control on the iPod/iPhone also adjusts the volume (max 0.0 dB) of this unit.

- When “iPod Interlock” → “Volume” in the Input menu is set to “Off,” the volume of this unit is not adjusted when iPod/iPhone volume controls are adjusted ([p. 86](#)).
- This unit may restrict the volume level to prevent excessively loud playback. In such a case, gradually increase the volume level.

CAUTION

When iPod/iPhone controls are used to adjust volume, playback volume may be unexpectedly loud. This could result in damage to this unit or the speakers. If the volume suddenly increases during playback, immediately remove the iPod/iPhone from the Wireless System for iPod. “Max Volume” can be used to specify the maximum volume level to prevent excessively loud playback ([p. 101](#)).

📶 1: This function is also activated when sound of application is reproduced or ringtone is received.

Playing back tunes from Bluetooth™ components

You can connect a Yamaha Bluetooth Wireless Audio Receiver (such as the YBA-10, sold separately) to this unit and enjoy wireless playback from Bluetooth-compatible portable music players. 🌟1

NOTE

When playing back from a Bluetooth component for the first time, you must first pair the devices (register the Bluetooth components). When establishing a wireless connection you must carry out pairing on both this unit and on the Bluetooth component.

Connecting a Yamaha Bluetooth Wireless Audio Receiver

Use the dedicated cable to connect the dock to the DOCK jack on the rear panel of this unit. The Bluetooth Wireless Audio Receiver connection will be complete when this unit is turned on.

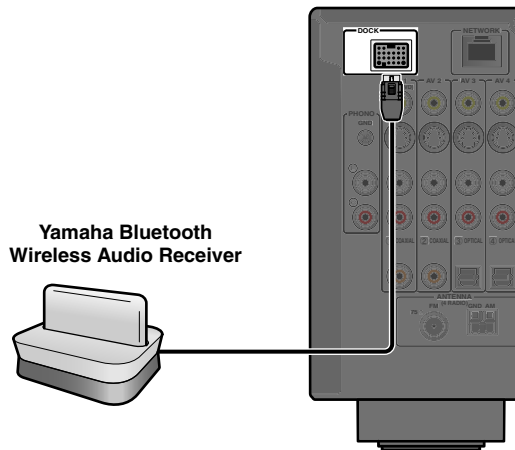

CAUTION

To prevent accidents, switch this unit to standby mode before connecting a Bluetooth Wireless Audio Receiver.

Pairing Bluetooth™ components

Be sure to carry out pairing when connecting a Bluetooth component for the first time, or when settings have been deleted. Refer to the operating instructions of your Bluetooth component as necessary when carrying out pairing.

The Yamaha Bluetooth Wireless Audio Receiver can be paired with up to eight Bluetooth components. When the ninth device is paired, the pairing settings for the device which has not been used for the longest period of time will be deleted.

- 1 Press **4 DOCK** to switch to the DOCK input.
- 2 Turn on the Bluetooth component you want to pair with and set it to pairing mode.
- 3 Press **16 OPTION** to display the Option menu and use **9 Cursor** Δ / ∇ to select "Pairing."



- 4 Press **9 ENTER** to start pairing.



- To cancel pairing, press **9 RETURN**.
- You can also press and hold **25 MEMORY** on the front panel to begin pairing.

- 5 Make sure the Bluetooth component recognizes the Bluetooth Wireless Audio Receiver.

When the device is recognized, it will appear in the Bluetooth component list, for example as "YBA-10 YAMAHA."

- 6 Select the Bluetooth Wireless Audio Receiver from the Bluetooth component list, and enter a pass key "0000" into the Bluetooth component. 🌟2

When pairing occurs correctly



🌟1 : This unit supports A2DP (Advanced Audio Distribution Profile) of the Bluetooth profile.

🌟2 : Depending on Bluetooth components, wireless connection is carried out right after the pairing. In this case, "BT connected" is displayed instead of "Completed."

Using Bluetooth™ components

When pairing is complete, perform the following procedure to achieve a wireless connection between this unit and the Bluetooth component. When the wireless connection is complete, Bluetooth components can be played back.

Depending on Bluetooth components, a wireless connection is established automatically or by operating the Bluetooth components. In that case, it is not necessary to carry out the following procedure.

1 Press **[4] DOCK** to switch to the DOCK input.

2 Press **[16] OPTION** to display the Option menu.

3 Use **[9] Cursor** Δ / ∇ to select “Connect” and press **[9] ENTER**.  **1**

When wireless connection is complete



“Not found” is displayed when there is an error connecting. Check that the following conditions have been satisfied, and try to establish a wireless connection again.

- Both this unit and the Bluetooth component are paired.
- The Bluetooth component is switched on.
- The Bluetooth component is within 10 m of the Bluetooth Wireless Audio Receiver.

4 Press **[16] OPTION** to exit the Option menu.

5 Operate the Bluetooth component for playback.

To disconnect a wireless connection, repeat the same steps, and in step 3, select “Disconnect.”

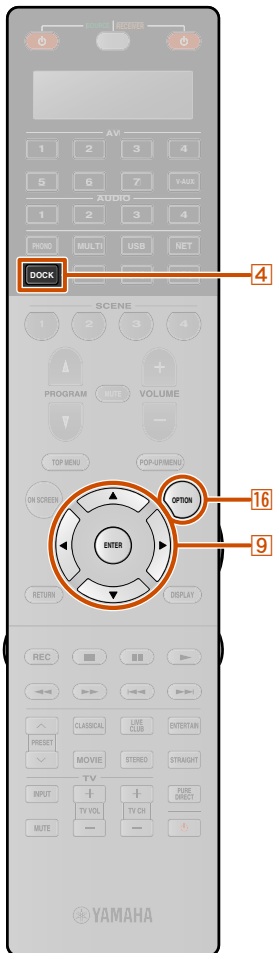

 **1**: “Disconnect” is displayed when a Bluetooth component has been connected.

Controlling this unit by using the Web browser (Web Control Center)

Displaying and Operating Web Control Center

You can operate this unit by using a web browser. You can select the input source and sound field program, browse the iPod or network/USB contents, select the preset items, and adjust the parameters of this unit by using the graphical user interface (Web Control Center) that appears in the web browser. Check the IP address of this unit by using "IP Address" in "Network" menu (p. 106) in advance, and then enter the IP address to the web browser to access this unit to control it.

NOTE

When "Network Standby" is set to "On" in the Network menu, this unit can turn on and Web Control Center can be displayed on the PC even if this unit was in standby mode (p. 106). When "Network Standby" is set to "Off," we recommend that "Network Standby" is set to "On" to use Web Control Center.

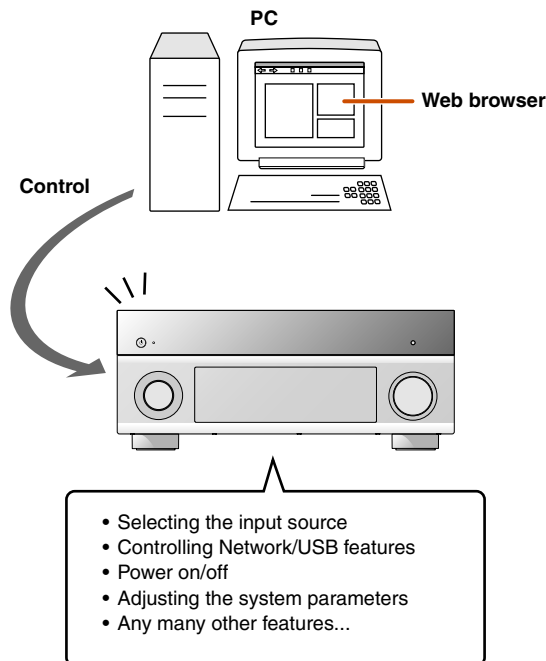

- To use this feature, this unit and your PC must be connected properly in the network. Refer to "Connecting to the network" for details on the connections (p. 39).
- We recommend that you use Windows Internet Explorer 8 that is installed on Windows XP or Windows 7 PC to access this unit.
- You can select whether this unit accepts the controls by using the web browser when this unit is in the standby mode.
- You can register the MAC address of the PCs you want to use to control this unit and limit the PCs that can control this unit by using the web browser. You can select that this unit allows the access to this unit by the PCs whose MAC addresses are registered to this unit or allows the access by any PCs by using "MAC Address Filter" in the "Network" setup (p. 106).

Features of Web Control Center for each zone

| Feature | Main Zone | Zone2/Zone3 | Zone4 |
|--|-----------|-------------|-------|
| Power on/off | ✓ | ✓ | ✓ |
| Sleep timer | ✓ | ✓ | ✓ |
| Input select | ✓ | ✓ | ✓ |
| Volume adjustment | ✓ | ✓ | — |
| Mute on/off | ✓ | ✓ | ✓ |
| Content/channel select | ✓ | ✓ | ✓ |
| Sound program | ✓ | — | — |
| Party Mode on/off | ✓ | ✓ | ✓ |
| Required settings for web browse control | ✓ | ✓ | ✓ |

Top menu

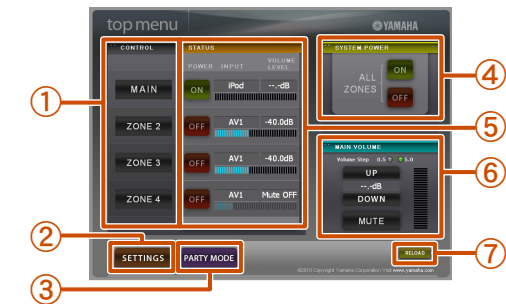

- CONTROL**
Changes the display to the zone control menu (p. 83).
- SETTINGS**
Changes the display to the settings menu (p. 83).
- PARTY MODE**
Enables/disables the party mode (p. 108).
- SYSTEM POWER**
Turns on/off the power for all zones.
- STATUS**
Turns on/off the power for each zone, and displays the selected input source and volume level for each zone.
- MAIN VOLUME**
Adjusts the volume level or mutes the sound for the main zone. You can also switch the step for the volume control.
- RELOAD**
Reloads the current status of the receiver.

Zone control menu

You can control the selected zone.





- ① **PLAY INFO**
Controls the selected input for each zone.
- ② **TOP MENU**
Returns to the top menu.
- ③ **SCENE keys**
Selects the scene.
- ④ **POWER**
Turns on/off the power for the selected zone. You can also set the sleep timer for the selected zone.
- ⑤ **VOLUME**
Adjusts the volume level or mutes the sound for the main zone. You can also switch the step for the volume control.
- ⑥ **RELOAD**
Reloads the current status of the receiver.

Settings menu

You can make various settings regarding the web browse control.



- ① **Zone Rename**
Friendly Name indicates the identification name of the device (this unit) connected to the PC.
Friendly Name or the names of zones can be changed.
- ② **MAC Filter**
Applies the MAC address filter to this unit. Web Control Center can only be accessed from a computer with the same address as the MAC address registered here.
- ③ **Auto Reload**
Enables or disables the Auto Reload function which reloads the current status of the receiver every 5 minutes.
- ④ **Tips 1/Tips 2**
Displays the tips for use of Web Control Center.
- ⑤ **Create Link**
Customizes the display of Web Control Center.
- ⑥ **iPhone** 
Selects the zoom rate for iPhone.
- ⑦ **BACK**
Returns to the top menu.
- ⑧ **RELOAD**
Reloads the current status of the receiver.

 1: This item appears only when accessing the Web Control Center with the iPhone.

SETUP

Configuring input sources (Input menu)

Settings, such as the name of an input source or the icon displayed for an input source can be changed from the Input menu.

Configuring input sources

The name of an input source and its icon, as well as other input source settings, can be changed from the Input menu displayed on the TV screen.

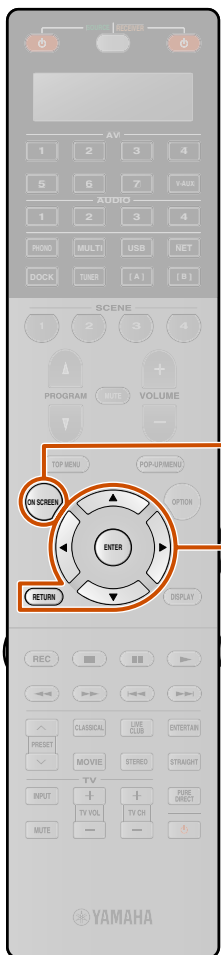

1 Press **[8]ON SCREEN**.

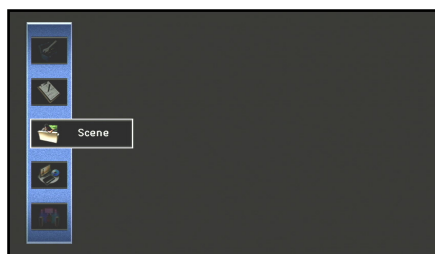

2 Use **[9]Cursor Δ / ▽** to select "Input" and press **[9]ENTER**.

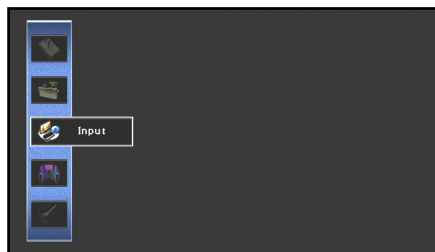

3 Use **[9]Cursor </>** to select an input source to be configured and press **[9]Cursor Δ**.

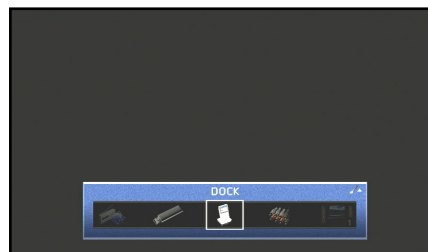

4 Use **[9]Cursor Δ / ▽** to select an item and press **[9]ENTER**.



If the selected item contains additional items, use **[9]Cursor Δ / ▽** to select the desired item and press **[9]ENTER**.

5 Use **[9]Cursor Δ / ▽** to adjust the setting.

Pressing **[9]RETURN** displays the previous menu screen. Repeat steps 4 to 5 to adjust multiple settings.

6 Press **[8]ON SCREEN** to close the menu.

Input menu

✓: available menu for each input source

| | AV1-7 | V-AUX | AUDIO1-4 | PHONO | MULTI CH | USB | PC | NET RADIO | DOCK (iPod) | DOCK (Bluetooth) | TUNER |
|---------------------------|-------|-------|----------|-------|----------|-----|----|-----------|-------------|------------------|-------|
| Rename/Icon Select | ✓ | ✓ | ✓ | ✓ | ✓ | ✓ | | | ✓ | ✓ | |
| Decoder Mode | ✓ | ✓ | ✓ | | | | | | | | |
| Enhancer | ✓ | ✓ | ✓ | ✓ | | ✓ | ✓ | ✓ | ✓ | ✓ | ✓ |
| DMC Control | | | | | | | ✓ | | | | |
| Standby Charge | | | | | | | | | ✓ | | |
| iPod Interlock | | | | | | | | | ✓🔒1 | | |
| Video Out | | | | | ✓ | | | | | | |



1 Changing an input source name or icon

Rename/Icon Select

Changes the input source name (up to nine characters) and icon displayed on the front panel display or TV screen.

- Use **[9]Cursor** Δ / ∇ repeatedly to select "Rename/Icon Select" and press **[9]ENTER**.

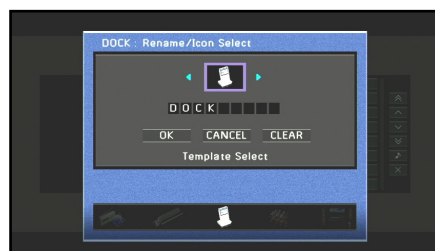

- Use **[9]Cursor** \leftarrow / \rightarrow to choose an icon.

- Press **[9]Cursor** ∇ and **[9]ENTER**.
Editing the name is available.

- Press **[9]Cursor** Δ / ∇ to select a character, and press **[9]Cursor** \leftarrow / \rightarrow to enter the selected character.

- Repeat step 4 to enter the desired input source name.

- Confirm the input source name by pressing **[9]ENTER**.

- Press **[9]Cursor** ∇ to select "OK" and press **[9]ENTER** to register the new input name.

- To cancel the operation without applying changes, select "CANCEL" and then press **[9]ENTER**.
- To clear the characters entered in step 5, select "CLEAR" and press **[9]ENTER**.

🔒1: Not available when playing back iPod/iPhone with wired connection.

Setting the format of digital audio signals

Decoder Mode

Sets the format of digital audio to playback to DTS. For example, if the format is not automatically detected correctly even during playback of DTS format audio, this item can be used to set the playback format to DTS.

| | |
|----------------|--|
| Auto (Default) | The audio format is automatically selected to match the format of the input audio. |
| DTS | Selects DTS signals only. Other input signals are not reproduced. |

Selecting the sound program suitable for listening to compressed audio, such as MP3

Enhancer

Turns on/off the Compressed Music Enhancer.

| | |
|-----|--|
| Off | Turns off the Compressed Music Enhancer. |
| On | Turns on the Compressed Music Enhancer. |

Using a PC to control this unit over a network

DMC Control

This unit can be operated via the DLNA compatible controller (e.g., Windows Media Player, etc.) to the same network as this unit. DMC stands for "Digital Media Controller."

| | |
|------------------|------------------------------------|
| Disable | Disables the DMC control function. |
| Enable (Default) | Enables the DMC control function. |

Charging an iPod™/iPhone™ in standby mode

Standby Charge

Charges an iPod/iPhone stationed in the Universal Dock for iPod or the receiver of the Wireless System for iPod while the receiver is in standby mode.

| | |
|----------------|---|
| Auto (Default) | This unit charges iPod/iPhone when this unit is in standby mode. While charging an iPod/iPhone, the HDMI Through/iPod Charge indicator lights. After the charging is complete, standby charge function is automatically off and the HDMI Through/iPod Charge indicator goes off. 🌱1 |
| Off | This unit does not charge iPod/iPhone. |

Setting the interlock functions with iPod/iPhone (when the receiver of the Wireless System for iPod is connected)

iPod Interlock

This unit can be automatically operated in conjunction with operations on iPod when the receiver of the Wireless System for iPod is connected to this unit.

| | |
|---------------|--|
| Power & Input | Starting playback of iPod/iPhone turns on this unit and switches the input source to DOCK (iPod) automatically when this item is set to "On." This unit automatically enters standby mode when iPod/iPhone is not operated for a while after playback is stopped. This interlock function is disable with "Off." |
| Volume | Adjusting the volume on the iPod/iPhone also adjusts the volume of this unit when this item is set to "On." This interlock function is disable with "Off." |

Outputting a video signal input from another input source while playing a multi-channel audio signal

Video Out

When "MULTI CH" is selected as the input source, a video signal input from another terminal can be output to the video monitor. For example, even if an audio and video component such as a DVD player that does not support a multi-channel digital audio output, the video signal can be output to the video monitor while reproducing a multi-channel analog audio signal.

🌱 1 : Standby charge function automatically turns off only when using YDS-10/11/12.

Editing the SCENE function (Scene menu)

The SCENE function ([p. 53](#)) can be edited from the Scene menu displayed on the TV screen.

Editing a scene

Various settings, such as the name of a scene or the icon displayed for a scene, can be changed from the Scene menu.

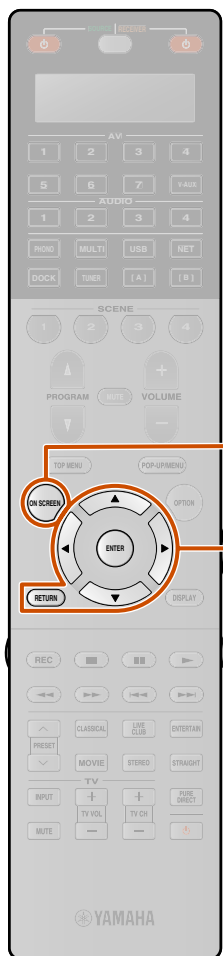

1 Press **[ON SCREEN]**.

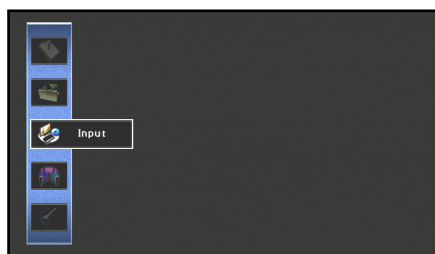

2 Use **[Cursor Δ / ▽]** to select “Scene” and press **[ENTER]**.

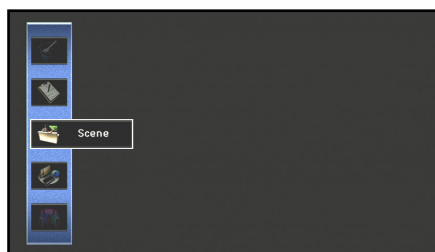

3 Use **[Cursor < / >]** to select a scene to be edited and press **[Cursor Δ]**.



4 Use **[Cursor Δ / ▽]** to select an item and press **[ENTER]**.

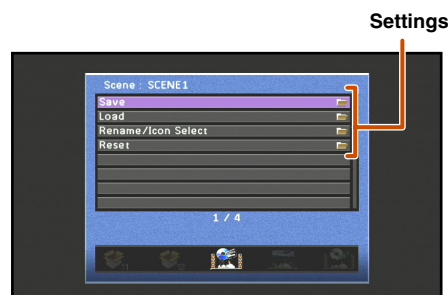

If the selected item contains additional items, use **[Cursor Δ / ▽]** to select the desired item and press **[ENTER]**.

5 Use **[Cursor Δ / ▽ / < / >]** to adjust the setting.

Pressing **[RETURN]** displays the previous menu screen. Repeat steps 4 and 5 to adjust multiple settings.

6 Press **[ON SCREEN]** to close the menu.

Scene menu

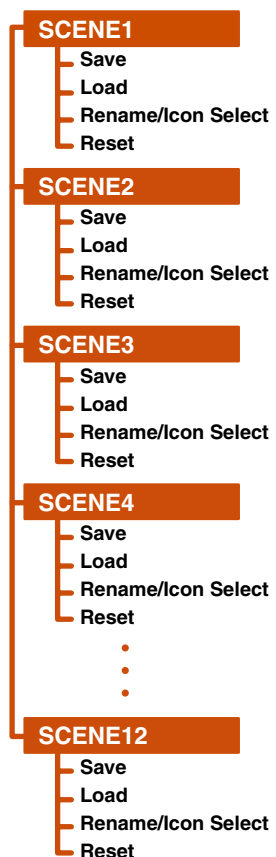

Scene 5 to 12 can also be edited in the Scene menu. Select Scene 5 to 12 in the Scene menu.

Registering SCENE function settings

Save

Registers the settings currently applied to this unit for each SCENE.

Adjusting settings registered with the SCENE function

Load

Loads input sources or sound programs that have been registered with the SCENE function, or specifies whether or not an external component registered as the input source is automatically turned on when a scene is selected.

| | |
|--------|---|
| OK | Loads items indicated with a check mark in "DETAIL." |
| CANCEL | Cancels settings applied with "DETAIL." |
| DETAIL | Specifies "SCENE IR" function and displays settings registered with the SCENE function in detail. For more information, see "SCENE IR" and "Detail" at right. |

SCENE IR

Specify whether or not a Yamaha BD/DVD player or CD player connected to this unit turns on automatically.

| | |
|-----------------------|--|
| Off | Disables the SCENE IR function. |
| Yamaha BD/DVD Player1 | Select this when a Yamaha BD/DVD player is connected to this unit. |
| Yamaha BD/DVD Player2 | Select this if the player dose not turn on when "Yamaha BD/DVD Player1" is selected. |
| Yamaha CD Player | Select this when a Yamaha CD player is connected to this unit. |

Detail

Display details of settings registered with the SCENE function. Items indicated with a check mark in "Setting" are loaded.

| | | |
|---------------|-------------------------------------|--|
| Input | <input checked="" type="checkbox"/> | Displays the "Input" and "Audio Select" settings registered with the SCENE function. |
| HDMI Output | <input checked="" type="checkbox"/> | Displays the HDMI output jack(s) registered with the SCENE function. |
| Mode | <input checked="" type="checkbox"/> | Displays the sound program registered with the SCENE function. |
| Sound | <input checked="" type="checkbox"/> | Displays the "Tone Control," "Adaptive DRC," and "Enhancer" settings registered with the SCENE function. |
| Surround | <input type="checkbox"/> | Displays the "CINEMA DSP 3D Mode," "Dialogue Lift," and "Extended Surround" settings registered with the SCENE function. |
| Video | <input type="checkbox"/> | Displays the "Video Processing" and "Video Adjustment" settings registered with the SCENE function. |
| Volume | <input type="checkbox"/> | Displays the volume setting registered with the SCENE function. |
| Lipsync | <input type="checkbox"/> | Displays the "Lipsync" and "Delay" settings registered with the SCENE function. |
| Speaker Setup | <input type="checkbox"/> | Displays the "Setting Pattern" and "PEQ Select" settings registered with the SCENE function. |

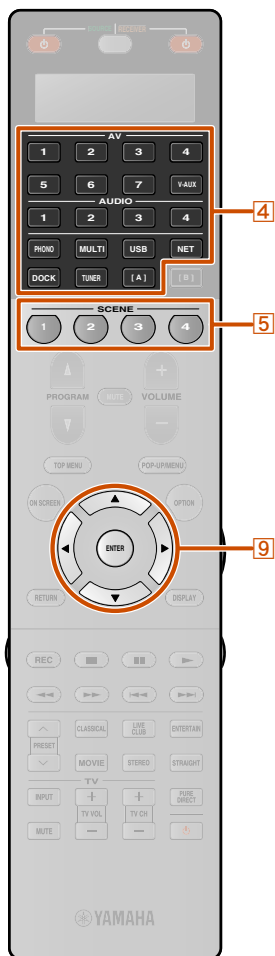

Changing a scene name and icon

Rename/Icon Select

Changes the scene name and icon displayed on the front panel display or TV screen.

1 Use **[9]Cursor** Δ / ∇ repeatedly to select “Rename/Icon Select” and press **[9]ENTER**.

2 Use **[9]Cursor** \leftarrow / \rightarrow to choose an icon.



3 Press **[9]Cursor** ∇ and **[9]ENTER**.
Editing the name is available.

4 Press **[9]Cursor** Δ / ∇ to select a character, and press **[9]Cursor** \leftarrow / \rightarrow to enter the selected character.

Scene names may consist of up to 20 characters.

5 Repeat step 4 to enter the desired scene name.

6 Confirm the scene name by pressing **[9]ENTER**.

7 Press **[9]Cursor** ∇ to select “OK” and press **[9]ENTER** to register the new input name.

- To cancel the operation without applying changes, select “CANCEL” and then press **[9]ENTER**.
- To clear the characters entered in step 4, select “CLEAR” and press **[9]ENTER**.

Resetting a scene

Reset

Restores all settings for the selected scene to their default values.

Simple registering as the SCENE

1 Use **[4]Input selector** to select the input source you want to register.

2 Set the settings such as sound program, Compressed Music Enhancer, or HDMI OUT you want to register.

The following settings can be registered with a scene 1:

Input, Audio Select, HDMI Output, Sound Program, Pure Direct Mode, Tone Control, Adaptive DRC, Compressed Music Enhancer, CINEMA DSP 3D Mode, Dialogue Lift, Extended Surround, Video Adjustment, Video Processing, Master Volume, Lipsync, Setting Pattern, PEQ Select

3 Press the **[5]SCENE** key until “SET Complete” appears on the front panel display.



Release the key when “SET Complete” is displayed

When changing “SCENE,” also change the external component that the remote control operates ([p. 115](#)).

1: Settings that are not checked in the Scene menu’s “Load” item are not enabled when the corresponding scene key is pressed.

Setting sound program parameters (Sound Program menu)

Sound effects can be adjusted from the Sound Program menu.

Editing sound programs

Adjust sound field elements (sound program parameters) to achieve sound effects suited to the acoustics of audio/video sources or rooms if you are not satisfied with the results achieved with default sound program settings. Follow the procedure described below to adjust sound program parameters.

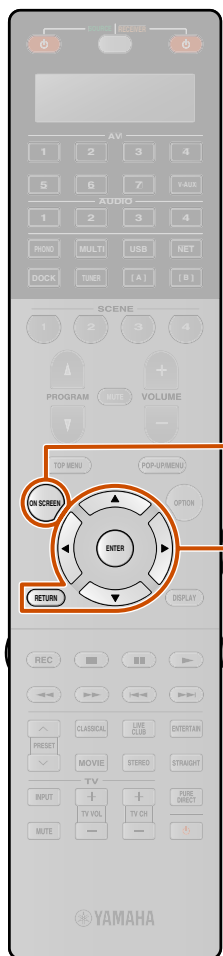

1 Press **[8] ON SCREEN**.

2 Press **[9] Cursor Δ / ▽** to select “Sound Program” and press **[9] ENTER**.

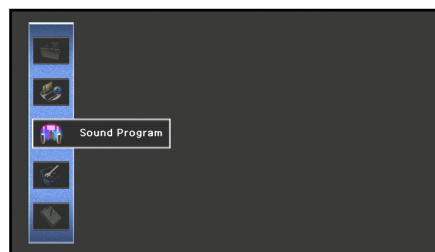

3 Use **[9] Cursor </>** to select a sound program and press **[9] Cursor Δ**.

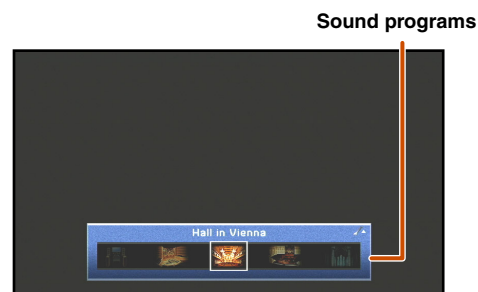

4 Use **[9] Cursor Δ / ▽** to select a parameter and press **[9] ENTER**.

Sound program parameters

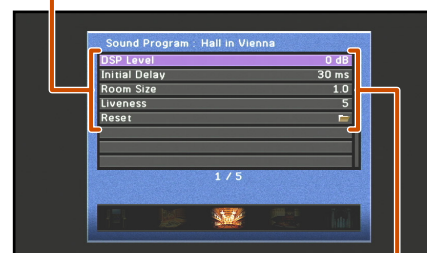

Settings

5 Use **[9] Cursor Δ / ▽ / </>** to adjust the parameter and press **[9] RETURN**. **💡1**

When there are multiple parameters in the selected sound program, repeat steps 4 and 5 to adjust other parameters.

6 Press **[8] ON SCREEN** to close the Sound Program menu.

■ To initialize sound program parameters

To set the parameters of the sound program back to their default settings, use **[9] Cursor Δ / ▽** repeatedly to select “Reset” in step 4 and press **[9] ENTER**. When the following message is displayed, select “OK” and press **[9] ENTER** to initialize.



To cancel initializing, select “CANCEL” and press **[9] ENTER** when the message above is displayed.

💡1 : An asterisk (*) appears on the left of the sound field parameter name displayed on the TV when you change the parameter from its default setting.

CINEMA DSP parameters

DSP Level

Change the effect level (level of the sound field effect to be added). You can adjust the level of the sound field effect while checking the sound effect.

| | |
|------------------|----------------|
| Adjustable range | -6 dB to +3 dB |
| Default setting | 0 dB |

Adjust "DSP Level" as follows:

- The effect sound is too soft.
→ Increase the effect level.
- There are no differences between effects of the sound programs.
→ Increase the effect level.
- The sound is dull.
→ Increase the effect level.
- The sound field effect is added too much.
→ Reduce the effect level.

Initial Delay

Surround Initial Delay

Surround Back Initial Delay

Initial delay. Presence, surround, and surround back sound field initial delay. Changes the apparent size of the sound field by adjusting the delay between the direct sound and the first reflection heard by the listener. The smaller the value, the smaller the sound field seems to the listener.

| | |
|------------------|---|
| Adjustable range | 1 to 99 ms (Initial Delay) 1 to 49 ms (Surround Initial Delay and Surround Back Initial Delay) |
|------------------|---|

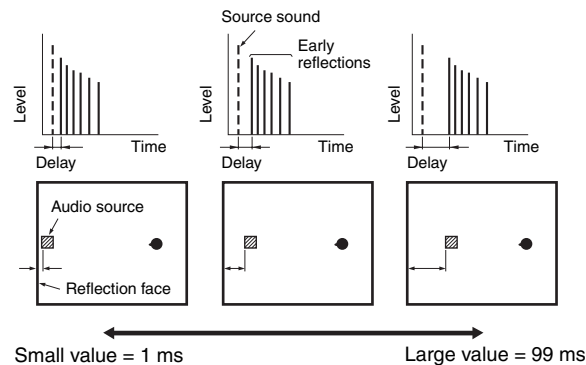

When you adjust the initial delay parameters, we also recommend that you adjust the corresponding room size parameters likewise.

Room Size

Surround Room Size

Surround Back Room Size

Room size. Presence, surround, and surround back room size. Adjusts the apparent size of the sound field. The larger the value, the larger the surround sound field becomes. As the sound is repeatedly reflected around a room, the larger the hall is, the longer the time between the original reflected sound and the subsequent reflections. By controlling the time between the reflected sounds, you can change the apparent size of the virtual venue. Changing this parameter from one to two doubles the apparent length of the room.

| | |
|------------------|------------|
| Adjustable range | 0.1 to 2.0 |
|------------------|------------|

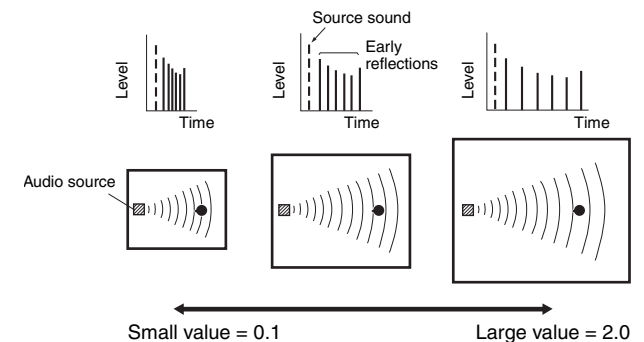

When you adjust the room size parameters, we also recommend that you adjust the corresponding initial delay parameters likewise.

Liveness

Surround Liveness

Surround Back Liveness

Liveness. Surround and surround back liveness. Adjusts the reflectivity of the virtual walls in the hall by changing the rate at which the early reflections decay. The early reflections of an audio source decay much faster in a room with acoustically absorbent wall surfaces than in one which has highly reflective surfaces. A room with acoustically absorbent surfaces is referred to as “dead,” while a room with highly reflective surfaces is referred to as “live.” This parameter lets you adjust the early reflection decay rate and thus the “liveness” of the room.

| | |
|-------------------------|---------|
| Adjustable range | 0 to 10 |
|-------------------------|---------|

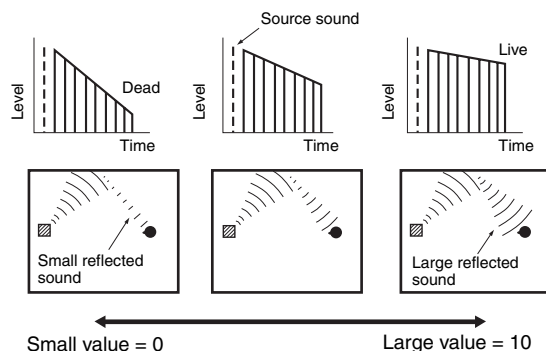

Reverb Time

Reverberation time. Adjusts the amount of time taken for the dense, subsequent reverberation sound to decay by 60 dB at 1 kHz. This changes the apparent size of the acoustic environment over an extremely wide range. Set a longer reverberation time to get more sustaining reverberation sound, and set a shorter time to get articulate sound.

| | |
|-------------------------|--------------|
| Adjustable range | 1.0 to 5.0 s |
|-------------------------|--------------|

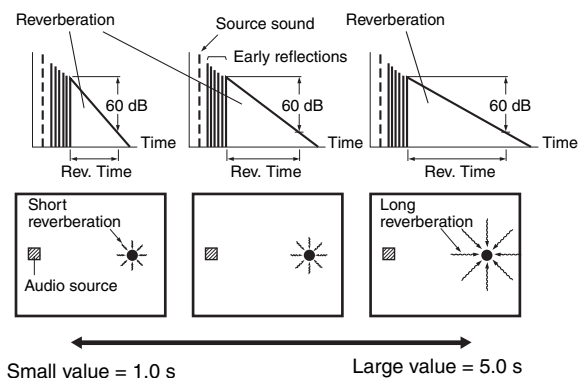

Reverb Delay

Reverberation delay. Adjusts the time difference between the beginning of the direct sound and the beginning of the reverberation sound. The larger the value, the later the reverberation sound begins. A later reverberation sound makes you feel as if you are in a larger acoustic environment.

| | |
|-------------------------|-------------|
| Adjustable range | 0 to 250 ms |
|-------------------------|-------------|

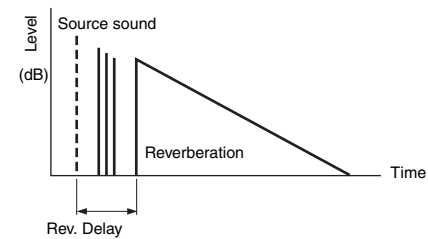

Reverb Level

Reverberation level. Adjusts the volume of the reverberation sound. The larger the value, the stronger the reverberation becomes.

| | |
|-------------------------|-----------|
| Adjustable range | 0 to 100% |
|-------------------------|-----------|

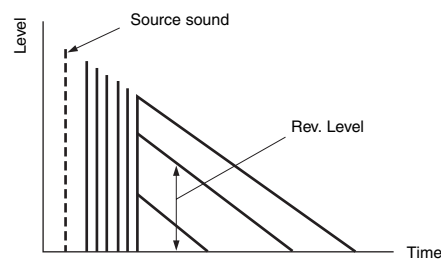

Decode Type

Selects a surround decoder to be used with a sound program in the MOVIE category. 🌟1

| | |
|---------------------------|--|
| PLIIx Movie PLII Movie | Selects the Dolby Pro Logic IIx Movie (or Dolby Pro Logic II Movie) decoder. |
| Neo:6 Cinema | Selects the Neo:6 (Cinema) decoder. |

Parameters usable in certain sound programs

2ch Stereo only

Direct

Automatically bypasses the DSP circuit and tone control circuit depending on the condition of tone control etc., when an analog audio source is played back. You can enjoy a higher quality sound.

| | |
|-----------------------|---|
| Auto (Default) | Outputs sound by bypassing the DSP circuit and tone control circuit when both tone controls of “Bass” and “Treble” are set to 0 dB. |
| Off | Does not bypass the DSP circuit and tone control circuit. |

7ch Stereo only

Center Level

Adjusts the center channel volume. 🌟2

| | |
|-------------------------|-----------|
| Adjustable range | 0 to 100% |
| Default setting | 100% |

Surround L Level

Adjusts the volume of the surround L channel. 🌟2

| | |
|-------------------------|-----------|
| Adjustable range | 0 to 100% |
| Default setting | 100% |

Surround R Level

Adjusts the volume of the surround R channel. 🌟2

| | |
|-------------------------|-----------|
| Adjustable range | 0 to 100% |
| Default setting | 100% |

Surround Back L Level

Adjusts the volume of the surround back L channel. 🌟2

| | |
|-------------------------|--|
| Adjustable range | 0 to 100% |
| Default setting | 35% (7.1-channel configuration) 50% (6.1-channel configuration) |

Surround Back R Level

Adjusts the volume of the surround back R channel. 🌟2

| | |
|-------------------------|--|
| Adjustable range | 0 to 100% |
| Default setting | 35% (7.1-channel configuration) 50% (6.1-channel configuration) |

Front Presence L Level

Adjusts the volume of the front presence L channel. 🌟2

| | |
|-------------------------|-----------|
| Adjustable range | 0 to 100% |
| Default setting | 33% |

🌟1: Surround decoders cannot be changed when used with the following MOVIE and ENTERTAINMENT sound programs.

- Mono Movie
- Sports
- Action Game
- Roleplaying Game

🌟2: Not displayed when speakers are set to be inactive.

Front Presence R Level



Adjusts the volume of the front presence R channel. 

| | |
|-------------------------|-----------|
| Adjustable range | 0 to 100% |
| Default setting | 33% |

Parameters usable in surround decoder

Decode Type

Selects a surround decoder.

| | |
|--------------------------|--|
| Pro Logic | Reproduces sound using the Dolby Pro Logic decoder. This is suitable for all kinds of audio sources. |
| PLIIx Movie / PLII Movie | Reproduces sound using the Dolby Pro Logic IIx (or Dolby Pro Logic II) decoder. This is suitable for movies.  |
| PLIIx Music / PLII Music | Reproduces sound using the Dolby Pro Logic IIx (or Dolby Pro Logic II) decoder. This is suitable for music.  |
| PLIIx Game / PLII Game | Reproduces sound using the Dolby Pro Logic IIx (or Dolby Pro Logic II) decoder. This is suitable for games.  |
| Neo:6 Cinema | Reproduces sound using the DTS Neo:6 decoder. This is suitable for movies. |
| Neo:6 Music | Reproduces sound using the DTS Neo:6 decoder. This is suitable for music. |

Dolby PLIIx Music and Dolby PLII Music only

Panorama

Adjusts the soundscape of the front sound field. Sends front left/right channels sounds to the surround speakers as well as the front speakers for a wraparound effect.

| | |
|---------------|----------------------|
| Off (Default) | Disables the effect. |
| On | Enables the effect. |

Center Width

Spreads the center channel sound to the front left and right speakers to suit your needs or preferences. Set this parameter to 0 for outputting the center sound from the center speaker only, or to 7 for outputting it from the front left/right speaker only.

| | |
|-------------------------|--------|
| Adjustable range | 0 to 7 |
| Default setting | 3 |

Dimension

Adjusts the difference in level between the front sound field and the surround sound field. You can adjust the difference in level created by the software being played back to obtain the preferred sound balance. The surround sound gets stronger as you make the value more negative, and the front sound gets stronger as you make the value more positive.

| | |
|-------------------------|----------|
| Adjustable range | -3 to +3 |
| Default setting | 0 |

When Neo:6 Music is selected

Center Image

Adjusts the front left and right channel output relative to the center channel to make the center channel more or less dominant as necessary.

| | |
|-------------------------|------------|
| Adjustable range | 0.0 to 1.0 |
| Default setting | 0.3 |

 1: Not displayed when speakers are set to be inactive.

 2: You cannot select the Dolby Pro Logic IIx decoder in the following conditions:

- When "Surround Back" is set to "None" ([**p. 98](#)).
- When headphones are connected.

Setting various functions (Setup menu)

Various settings, such as speaker volume or HDMI functions, can be changed from the Setup menu.

Operating the Setup menu

- 1 Press **[8] ON SCREEN**.
- 2 Press **[9] Cursor Δ / ∇** repeatedly to select "Setup" and press **[9] ENTER**.

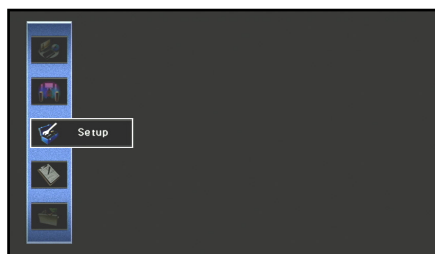
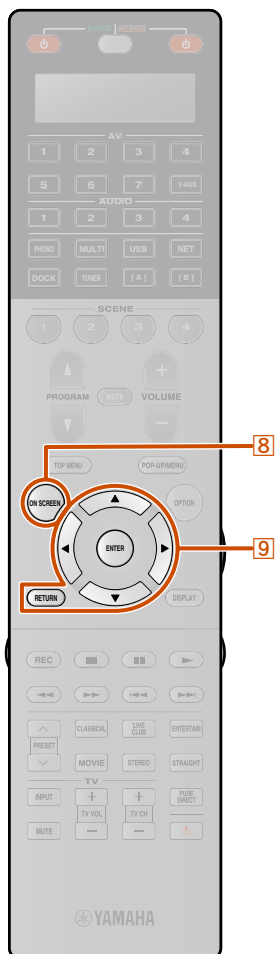

- 3 Use **[9] Cursor \leftarrow / \rightarrow** to select a menu and press **[9] ENTER**.

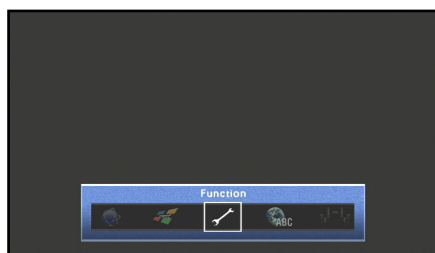

Setup menus

| | |
|------------|---|
| Speaker | Adjusts parameters for speakers, such as speaker status, and volume adjustment for each speaker (p. 96). |
| Sound | Sets functions related to audio output, such as adjustment of maximum volume and of dynamic range (p. 100). |
| Video | Sets video output functions, such as video conversion settings (resolution and aspect ratio) (p. 102). |
| HDMI | Sets HDMI functions, such as the HDMI Control function and output destination for HDMI sound (p. 104). |
| Network | Sets network status, such as IP Address or MAC Address Filter (p. 106). |
| Multi Zone | Sets multi-zone functions, such as volume adjustment for speakers in the secondary zone (p. 107). |
| Function | Sets functions such as the Auto Power Down function, that make the unit easier to use (p. 109). |
| Language | Selects the language of the menus and messages displayed on TV screen (p. 112). |

- 4 Use **[9] Cursor Δ / ∇** to select an item and press **[9] ENTER**.



When the selected item contains detailed ones, use **[9] Cursor Δ / ∇** to select the detailed item and press **[9] ENTER**.

- 5 Use **[9] Cursor $\Delta / \nabla / \leftarrow / \rightarrow$** to adjust the setting.

Pressing **[9] RETURN** displays the previous menu. Repeat steps 4 to 5 to adjust multiple settings.

- 6 Press **[8] ON SCREEN** to close the menu.

Setup menu

Speaker

- Auto Setup
- Manual Setup

Sound

- Lipsync
- Dynamic Range
- Max Volume
- Initial Volume
- Pure Direct Mode
- Adaptive DSP Level

Video

- Analog to Analog Conversion Processing

HDMI

- HDMI Control
- Control Select
- ARC (Audio Return Channel)
- TV Audio Input
- Audio Output
- Standby Through

Network

- IP Address
- Network Standby
- MAC Address Filter

Multi Zone

- Zone2 Set
- Zone3 Set
- Digital Out Assign
- Monitor Out Assign
- Party Mode Set
- Zone Scene Rename
- Zone Rename

Function

- Auto Power Down
- Input Assignment
- Display Set
- Trigger Output1
- Trigger Output2
- Memory Guard

Language

Manages settings for speakers



Speaker setup items

| | |
|--------------|--|
| Auto Setup | Optimizes the speaker configuration automatically. |
| Manual Setup | Manually adjusts parameters for speakers. |

Automatic speaker setup

Auto Setup

Optimizes the speaker configuration automatically using YPAO (p. 42).

Manual speaker setup

Manual Setup

The following parameters can be specified manually.

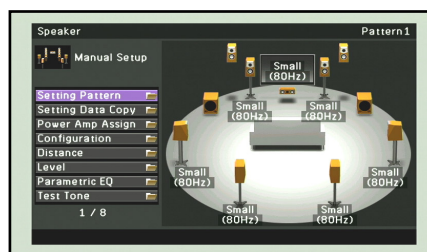

| | |
|-------------------|--|
| Setting Pattern | Registers two speaker setting patterns and switches between the two. |
| Setting Data Copy | Copies "Setting Pattern" data. |
| Power Amp Assign | Adds the extra speakers to the 7.1-channel speaker connection. |
| Configuration | Manually manages speaker configuration, such as speaker size (sound production capacity), and bass audio processing. |
| Distance | Manually adjusts the output of each speaker based on distance to the listening position. |
| Level | Manually adjusts the volume of each speaker. |
| Parametric EQ | Selects an equalizer to adjust speaker output characteristics. |
| Test Tone | Generates test tones. |

Setting Pattern

Registers two patterns for "Power Amp Assign," "Configuration," "Level," "Distance," and "Parametric EQ" settings and switches between the two setting patterns.

When the automatic speaker setup (YPAO) is performed, the result of measurement is registered on the currently selected Setting Pattern.

Setting Data Copy

Copies "Setting Pattern" data in the specified direction.

| | |
|--------------|---------------------------------------|
| Pattern1 ▶ 2 | Copies Pattern1 settings to Pattern2. |
| Pattern2 ▶ 1 | Copies Pattern2 settings to Pattern1. |

Power Amp Assign

In addition to the 7.1-channel speaker connection, various speaker configurations are possible using the presence speakers connection, bi-amp connection or multi-zone function (p. 20, p. 21).

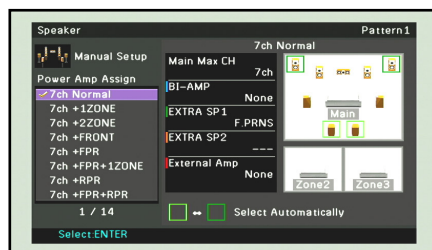

| | |
|----------------|---|
| 7ch Normal | Enables the normal 7-channel speakers and front presence speakers (p. 16). |
| 7ch +1ZONE | Enables the normal 7-channel speakers and zone2 or zone3 speakers (p. 18). The Zone assigned to EXTRA SP1 can be selected from Zone2 or Zone3. |
| 7ch +2ZONE | Enables the normal 7-channel, Zone2 and Zone3 speakers (p. 19). The Zone assigned to EXTRA SP1/EXTRA SP2 can be selected from Zone2 or Zone3. |
| 7ch +FRONT | Enables the normal 7-channel speakers and external front speakers (p. 23). |
| 7ch +FPR | Enables the normal 7-channel speakers and external front presence speakers (p. 23). |
| 7ch +FPR+1ZONE | Enables the normal 7-channel speakers, external front presence speakers and zone speakers (p. 24). The Zone assigned to EXTRA SP1 can be selected from Zone2 or Zone3. |
| 7ch +RPR | Enables the normal 7-channel speakers and external rear presence speakers (p. 24). |

| | |
|--------------------|--|
| 7ch +FPR+RPR | Enables the normal 7-channel speakers, and external front and rear presence speakers (p. 24). |
| 7ch +FPR+RPR+1ZONE | Enables the normal 7-channel speakers, external front and rear presence speakers and zone speakers (p. 25). The Zone assigned to EXTRA SP1 can be selected from Zone2 or Zone3. |
| 5chBI-AMP | Enables the bi-amp connection (p. 18). |
| 5chBI-AMP +FPR | Enables the bi-amp connection and external presence speakers (p. 25). |
| 5chBI-AMP +SB | Enables the bi-amp connection and external surround back speakers (p. 25). |
| 5chBI-AMP +SB+FPR | Enables the bi-amp connection, external surround back and front presence speakers (p. 26). |
| 5chBI-AMP +FPR+RPR | Enables the bi-amp connection, external front and rear presence speakers (p. 26). |

Configuration

Displays the speakers connected to this unit or adjusts the output characteristics of the speakers.

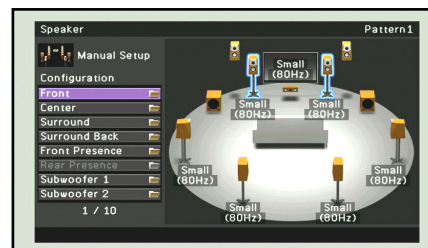

In the “Configuration,” you can select the speaker size characteristic (Large or Small). Select the size (sound reproduction capacity) that matches your speakers.

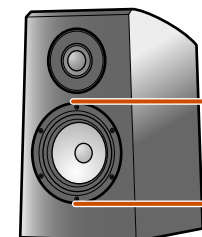

Woofer diameter

- 16 cm or larger → Large
- 16 cm or smaller → Small

When speaker size is set to “Small,” low-frequency components of the speakers that you configured are produced from the subwoofer (or from the front speakers if there is no subwoofer).

Front

Selects the size (sound reproduction capacity) of the front speakers. 1

| | |
|-----------------|---|
| Large | Select this for large speakers. The front speakers will produce all of the front channel frequency components. |
| Small (Default) | Select this for small speakers. The subwoofer will produce front channel low-frequency components. The crossover frequency can be selected from 40Hz, 60Hz, 80Hz (Default), 90Hz, 100Hz, 110Hz, 120Hz, 160Hz, or 200Hz. All frequencies below the selected frequency will be sent to the subwoofer. |

1: When “Subwoofer1” and “Subwoofer2” are set to “None,” you can only choose “Large.” If the front speaker setting is “Small” and you change “Subwoofer1” and “Subwoofer2” to “None,” it will automatically change to “Large.”

Center

Selects the size of the center speaker.

| | |
|------------------------|--|
| Large | Select this when a large center speaker is connected. |
| Small (Default) | Select this when a small center speaker is connected. The crossover frequency can be selected from 40Hz, 60Hz, 80Hz (Default) , 90Hz, 100Hz, 110Hz, 120Hz, 160Hz, or 200Hz when selecting this. All frequencies below the selected frequency will be sent to the subwoofer. |
| None | Select this when there is no center speaker. The front speakers will produce center channel audio. |

Surround

Selects the size of the surround speakers.

| | |
|------------------------|--|
| Large | Select this when the surround speakers are large. |
| Small (Default) | Select this when the surround speakers are small. The crossover frequency can be selected from 40Hz, 60Hz, 80Hz (Default) , 90Hz, 100Hz, 110Hz, 120Hz, 160Hz, or 200Hz when selecting this. All frequencies below the selected frequency will be sent to the subwoofer. |
| None | Select this when no surround speakers are connected. The front speakers will produce surround channel audio signals. |

- When set to “None,” no sound is produced from the surround back speaker even if that speaker is connected.
- When set to “None,” the sound programs will change to Virtual CINEMA DSP mode.

Surround Back

Selects the size of the surround back speakers.

| | |
|--------------------------|---|
| Largex1 | Select when one large surround back speaker is connected. |
| Largex2 | Select when two large surround back speakers are connected. |
| Smallx1 | Select when one small surround back speaker is connected. |
| Smallx2 (Default) | Select when two small surround back speakers are connected. |
| None | Select this when no surround back speakers are connected. |

- When there are no surround speakers are connected, the setting will automatically change to “None.”
- You can set surround back audio signals, including from the playback source, to be mixed down and produced from a single speaker (6.1-channel layout) or produced from left and right surround speakers (5.1-channel layout).

Front Presence

Specify connection of front presence speakers.

| | |
|----------------------|---|
| Use (Default) | Select this when front presence speakers are connected. |
| None | Select this when front presence speakers are not connected. |

Rear Presence

Specify connection of rear presence speakers.

| | |
|----------------------|--|
| Use (Default) | Select this when rear presence speakers are connected. |
| None | Select this when rear presence speakers are not connected. |

Subwoofer1 / Subwoofer2

Confirms the subwoofer.

| | |
|----------------------|--|
| Use (Default) | Select this when subwoofer is connected. During playback, the subwoofer will produce audio from the LFE (low-frequency effect) channel and bass audio from other channels.  1 Select the phase of the subwoofer from the following items if the bass audio is lacking or unclear. Normal (Default) Does not change the subwoofer phase. Reverse Reverses the subwoofer phase. |
| None | Select this when subwoofer is not connected. The front speakers will produce audio from the LFE (low-frequency effect) channel and bass frequency audio from other channels when both “Subwoofer1” and “Subwoofer2” are set to “None.” |

SWFR Layout

Select a layout of two subwoofers connected to this unit.

| | |
|------------------------------|--|
| Left + Right | Select when two subwoofers are arranged with one to the left and one to the right of this unit. |
| Front + Rear | Select when two subwoofers are arranged with one in front of and one behind this unit. |
| Monaural x2 (Default) | Select when two subwoofers are arranged in a manner not suited to either or the other setting options. |

 1: Enabling “Extra Bass” allows both the subwoofer and the front speakers to produce bass audio.

Extra Bass

Allows the front channel low-frequency components to be produced exclusively by the subwoofer, or by both the subwoofer and the front speakers.

| | |
|---------------|---|
| Off (Default) | Depending on the size of the front speakers, either the front speakers or the subwoofer produce the front channel low-frequency components. |
| On | The subwoofer and the front speakers produce the front channel low-frequency components. |

When “Subwoofer1” and “Subwoofer2” are set to “None” or “Front” is set to “Small,” “Extra Bass” is disabled.

Distance

Adjusts the timing at which the speakers produce audio so that sounds from the speakers reach the listening position at the same time.

Selecting adjustment units

Use **[9]Cursor Δ / ▽** to select the unit for distance (meters or feet), and press **[9]ENTER**.

Setting distances for each speaker

Use **[9]Cursor Δ / ▽** to select the speaker you want to configure, and press **[9]ENTER**.

Then use **[9]Cursor < / >** to set the distance from the speaker to your listening position.

| | |
|-----------------------|---|
| Adjustable range | 0.30 m to 24.00 m (1.0 ft. to 80.0 ft.) |
| Default setting | 3.00 m (10.0 ft.) |
| Adjustment increments | 0.05 m (0.2 ft.) |

Level

Separately adjusts the volume of each speaker.

Use **[9]Cursor Δ / ▽** to select the desired speaker, and press **[9]ENTER**.

Then use **[9]Cursor < / >** to adjust the volume for the selected speaker.

| | |
|-----------------------|----------------------|
| Adjustable range | -10.0 dB to +10.0 dB |
| Default setting | 0.0 dB |
| Adjustment increments | 0.5 dB |

You can also adjust the volume of each speaker by using

[27]LEVEL.

Press **[27]LEVEL** and use **[9]Cursor Δ / ▽** to select the desired speaker. Then use **[9]Cursor Δ / ▽** to adjust the volume for the selected speaker.

Parametric EQ

Adjusts sound quality of tone using a parametric equalizer.

PEQ Select

Select an equalizer type.

| | |
|-------------------|---|
| Manual | Manually adjust equalizer sound. |
| Flat | Adjust individual speakers to achieve the same characteristics. Select this option if speakers offer the same quality. |
| Front | Adjust individual speakers to achieve the same characteristics as the front left and right speakers. Select this option if front left and right speakers offer significantly greater quality than other speakers. |
| Natural | Adjust all speakers to achieve a natural sound. Select this if high-frequency sounds seem too strong when “PEQ Select” is set to “Flat.” |
| Through (Default) | Disable the equalizer. |

PEQ Data Copy

Select 1 of the 3 parametric equalizer types acquired with automatic setup and manually copy that information to the manual adjustments.

| | |
|------------------|--|
| Flat ▶ Manual | Copy the “Flat” parametric equalizer information acquired with automatic setup. |
| Front ▶ Manual | Copy the “Front” parametric equalizer information acquired with automatic setup. |
| Natural ▶ Manual | Copy the “Natural” parametric equalizer information acquired with automatic setup. |

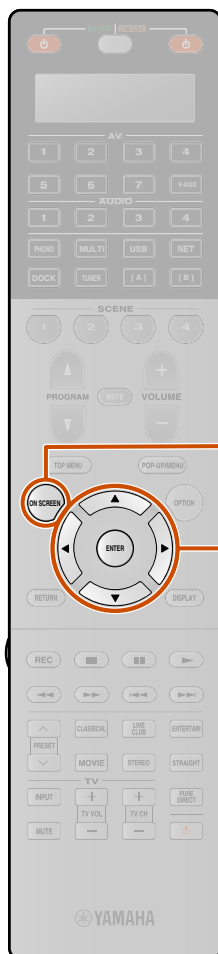

Front L / Front R / Center / Surround L / Surround R / Surround Back L / Surround Back R / Front Presence L / Front Presence R / Rear Presence L / Rear Presence R / Subwoofer1 / Subwoofer2

The parametric equalizer can be used to manually adjust sound quality for individual speakers.

Set "PEQ Select" to "Manual" and use "PEQ Data Copy" to copy information acquired with automatic setup. This information can be used as a basis for performing manual adjustments.

1 Use **[9]Cursor Δ / ▽** repeatedly to select "Band / Gain," "Freq. / Gain," or "Q / Gain" and press **[9]ENTER**.

2 Use **[9]Cursor < / >** repeatedly to adjust the parameter and use **[9]Cursor Δ / ▽** repeatedly to adjust the gain.

3 Press **[9]ENTER** to exit the edit window.

4 Repeat steps 1 to 3 to configure other parameters.

To reset all parameter settings for the selected speaker, select "Yes" in "Reset" and press **[9]ENTER**.

5 Press **[8]ON SCREEN** to close the menu.

Test Tone

Turns the test tone generator on or off.

| | |
|---------------|---|
| Off (Default) | Does not generate test tones. |
| On | Generates test tones. While "On" is selected, test tones are produced constantly. |

You can use the test tone in a variety of circumstances. For example, you can adjust the volume balance settings for each speaker, or whenever you adjust the settings on the internal parametric equalizer, you can listen to the actual effect while operating this unit. Turn the test tone off when you have finished making adjustments.

Setting the audio output function of this unit

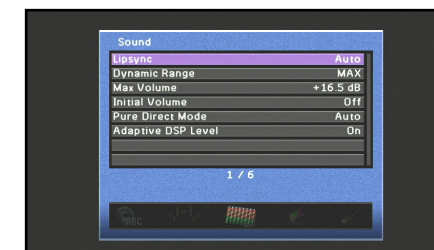

Sound setup items

| | |
|--------------------|---|
| Lipsync | Adjusts the delay between video and audio output. |
| Dynamic Range | Selects the dynamic range adjustment method for Dolby Digital and DTS playback. |
| Max Volume | Sets the maximum volume for this receiver. |
| Initial Volume | Sets the initial volume for when this receiver is turned on. |
| Pure Direct Mode | Selects whether or not this unit outputs video signal in Pure Direct Mode. |
| Adaptive DSP Level | Adjusts the level of DSP effect in conjunction with the volume level. |

Synchronizing audio/video output

Lipsync

Adjusts the delay between audio and video output (Lipsync function).

Selects a compensation method for the delay between audio and video output.

| | |
|--|---|
| Auto (Default)  | When connecting to a TV via HDMI, automatically adjusts output timing if the TV supports an automatic lipsync function. |
| Manual | Manually adjusts the correction time. Select this when the monitor does not support the automatic lipsync function. |

| | |
|-----------------------|----------------|
| Adjustable range | 0 ms to 250 ms |
| Default setting | 0 ms |
| Adjustment increments | 1 ms |

Auto-adjusting Dolby Digital and DTS dynamic range

Dynamic Range

Selects the dynamic range adjustment method for audio bitstream (Dolby Digital and DTS) signal playback.

| | |
|---------------|--|
| MAX (Default) | Produces audio without adjusting the dynamic range. |
| STD | Adjusts the dynamic range for optimum volume for regular home use. |
| MIN/AUTO | (MIN) Sets the dynamic range suitable for low volume or a quiet environment, such as at night, for bitstream signals except for Dolby TrueHD signals. (AUTO) Adjusts the dynamic range for Dolby TrueHD signals based on input signal information. |

Setting the maximum volume

Max Volume

Specify the maximum volume level so that sound is not too loud. The default setting of +16.5 dB produces the highest volume.

| | |
|-----------------------|---------------------------------------|
| Adjustable range | -30.0 dB to +16.5 dB (maximum volume) |
| Default setting | +16.5 dB |
| Adjustment increments | 5.0 dB |

Setting the startup volume

Initial Volume

Sets the initial volume for when this receiver is turned on. When this parameter is set to "Off," the volume is set at the level when the receiver last entered standby mode. 

| | |
|-----------------------|---------------------------------|
| Adjustable range | Off, Mute, -80.0 dB to +16.5 dB |
| Default setting | Off |
| Adjustment increments | 0.5 dB |

Video signal output in Pure Direct Mode

Pure Direct Mode

Selects whether or not this unit outputs video signal in Pure Direct Mode.

| | |
|----------------|--|
| Auto (Default) | Automatically output video signal when the input source equipping video signal input jacks or content window is selected. If no video signal is input, only the wall paper is displayed. |
| Video Off | Does not output video signal including the wall paper. |

 1: The setting is effective at the HDMI OUT jack selected by using  HDMI OUT.

 2: When you set "Max Volume" at a lower level than "Initial Volume," "Max Volume" has priority.

Adjusting DSP effect and volume level

Adaptive DSP Level

Automatically adjust the level of DSP effect in conjunction with the volume level.

| | |
|--------------|---|
| Off | Disables automatic adjustment of the level of DSP effect. |
| On (Default) | Adjusts the degree of DSP effect in conjunction with volume level. The higher the volume level, the less the DSP effect applied. The lower the volume level, the greater the DSP effect applied. This feature also corrects sound effect according to the result of automatic measurement. |

Setting this unit's video output function

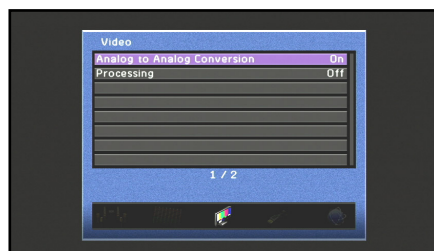

Video setup items

| | |
|-----------------------------|--|
| Analog to Analog Conversion | Enable or disable video conversion between analog video jacks. |
| Processing | Enable or disable adjustment of resolution, aspect ratio and video signal correction for video signal converted to HDMI video. |

Analog-to-analog video conversion

Analog to Analog Conversion

Enables or disables video conversion between analog video jacks.

| | |
|--------------|---|
| Off | Disables video conversion between analog video jacks. |
| On (Default) | Enables video conversion between analog video jacks. |

- Analog-to-HDMI video conversion is always possible unless video signals are being input at the HDMI input jacks or 1080p-resolution analog video signals are being input (p. 146).
- This unit does not convert 480 line video signals and 576 line video signals interchangeably.
- 480p-, 576p-, 1080i- and 720p-resolution video signals can not be output at the S-video and video jacks of MON.OUT/ZONE OUT (p. 146).
- The converted video signals are only output at the MONITOR OUT jacks.
- When composite video or S-video signals from a VCR are converted into component video signals, the picture quality may suffer depending on your VCR.
- Unconventional signals input at the composite video or S-video jacks cannot be converted or may be output abnormally. In such cases, set "Analog to Analog Conversion" to "Off."

Adjusting video with conversion of video signal to HDMI

Processing

Adjust video with conversion of video input to HDMI video.

| | |
|---------------|---|
| Off (Default) | Video are not adjusted with processing. |
| On | Video are adjusted with processing. |

Resolution

| | |
|----------------|---|
| Auto (Default) | Automatic upscaling in accordance with TV resolution. |
| 480p (576p) | Upscaling to 480p (576p). |
| 720p | Upscaling to 720p. |
| 1080i | Upscaling to 1080i. |
| 1080p | Upscaling to 1080p. |
| Through | No upscaling. |

- When a TV is connected to this unit via the HDMI jack, this unit automatically detects a resolution that the TV supports. Only the detected resolution can be selected.
- If this unit cannot detect the resolution that the TV supports, set "MONITOR CHECK" in the Advanced Setup menu to "SKIP" (p. 127) and try again.

 1 : This item can be set when set "Processing" to "On."

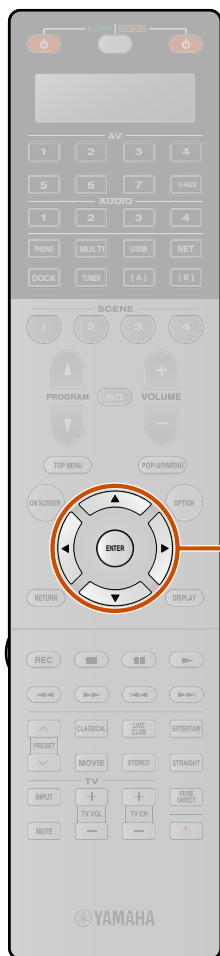

Aspect

Specifies the method used to convert video signal with a 4:3 aspect ratio (480i/576i/480p/576p) to the 16:9 aspect ratio (720p/1080i/1080p).

| | |
|-------------------|---|
| Through (Default) | Does not adjust the aspect ratio of video signal sources. |
| 16:9 Normal | Transmits 4:3 aspect ratio video signals to a 16:9 TV with black bands on either side of the screen. |
| Smart Zoom | Adjusts video images with an aspect ratio of 4:3 to fit video monitors with an aspect ratio of 16:9. When "Aspect" is set to "Smart Zoom," the edges of video images may be distorted with display on the video monitor. |

Adjustment

Adjusts video quality. The preset feature can also be used to save up to six preferred video quality settings.

1 Press  **Cursor** Δ / ∇ to select the preset and press  **ENTER**.

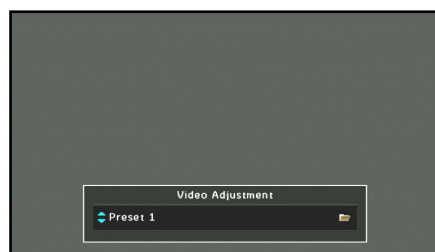

2 Press  **Cursor** Δ / ∇ to select the item you want to adjust.

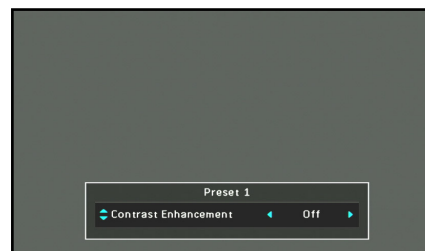

3 Press  **Cursor** \leftarrow / \rightarrow to adjust the following parameters and press  **ENTER**.

The settings are applied to the selected preset.

| | |
|------------------------|---|
| Contrast Enhancement | When this item is set to "Auto," image contrast is automatically enhanced. "Off" (Default) disables the contrast enhancement function. |
| Resolution Enhancement | When this item is set to "Auto," image resolution is automatically enhanced. "Off" (Default) disables the resolution enhancement function. When this item is set to "Manual," the control range for the following items can be adjusted manually. The setting of this item interlocks with the settings of the following items. – Detail Enhancement Enhances the detail of images. Control range: 0 (default) to 50 – Edge Enhancement Enhances the edges of images. Control range: 0 (default) to 50 |

| | |
|-----------------|---|
| Noise Reduction | When this item is set to "Auto," image noise is automatically reduced. "Manual" allows you to enhance image noise manually. "Off" (Default) disables the noise reduction function. The setting of this item interlock with the settings of the following items. When this item is set to "Manual," the setting levels of the following items can be selected. – Mosquito NR Reduces the flicker noise come out at the edges of image (mosquito noise). Settings: Low/Medium/High – Block NR Reduces the block noises of image. Block noise comes out frequently when playing back the low bit-rate video. Settings: Low/Medium/High – Temporal NR Reduces the temporal noise of image such as film-grain noise or random noise of analog video signals. Settings: Low/Medium/High |
| Brightness | Adjusts image brightness. Control range: -100 to +100 Initial setting: 0 |
| Contrast | Adjusts image contrast. Control range: -100 to +100 Initial setting: 0 |
| Saturation | Adjusts image saturation. Control range: -100 to +100 Initial setting: 0 |

 1: This item can be set when set "Processing" to "On."

Setting HDMI functions



HDMI setup items

| | |
|----------------------------|--|
| HDMI Control | Turns the HDMI Control on or off. |
| Control Select | Choose an HDMI OUT jack on which HDMI Control function is enabled. |
| ARC (Audio Return Channel) | Turns the Audio Return Channel function on or off. |
| TV Audio Input | Chooses automatically selected audio input in conjunction with TV operation when the HDMI Control is turned on. |
| Audio Output | Specifies whether or not audio signal is output through this unit and a TV connected via the HDMI OUT 1-2 jacks. |
| Standby Through | Turns the Standby Through function on or off. |

1: This item appears depending on “HDMI Control.”

Receiver operation via TV (HDMI Control)

HDMI Control

Set the HDMI Control function to “On” to operate devices connected via HDMI. If the TV or other external components support HDMI Control (e.g., Panasonic VIERA Link), you can use the remote controls of those devices to operate some of this unit’s functions, and to synchronize this unit with the operation of those devices.

Refer to “Using the HDMI Control function” ([p. 129](#)) for setting instructions.

| | |
|---------------|-----------------------------|
| Off (Default) | Sets HDMI Control to “Off.” |
| On | Sets HDMI Control to “On.” |

If this unit is connected to HDMI devices that do not support the HDMI Control function, these functions will not operate.

Selecting an HDMI OUT jack for the HDMI Control function

Control Select

Select the HDMI OUT jack that utilizes the HDMI Control function.

Refer to “Using the HDMI Control function” ([p. 129](#)) for setting instructions.

| | |
|-----------|--|
| OUT1(TV1) | Applies the HDMI Control function for the HDMI OUT 1 jack. |
| OUT2(TV2) | Applies the HDMI Control function for the HDMI OUT 2 jack. |

We recommend to unplug and re-plug the power cable of this unit and the TV when changing the Control Select.

2: When the HDMI Control is “On,” the Standby Through function is automatically enabled. When this unit enters standby mode, the audio and video signals from the last-selected HDMI input source will continue to be transmitted to the TV. The HDMI input source can only be changed using the remote control.

Listening to TV audio via single HDMI cable (Audio Return Channel)

ARC (Audio Return Channel)

You can enable or disable the Audio Return Channel function. When using a TV that supports Audio Return Channel function and the function is enabled, the TV’s audio output is transmitted to this unit via an HDMI cable.

The TV audio input to this unit is regarded as the input source selected in “TV Audio Input.”

By means of this function, you do not need to connect the TV’s audio output (digital audio output or analog audio output) to the unit.

| | |
|---------------|---|
| Off (Default) | Sets the Audio Return Channel to “Off.” |
| On | Sets the Audio Return Channel to “On.” |

When the TV audio is input to the unit using Audio Return Channel, “TV” is displayed on the front panel display.



- “ARC (Audio Return Channel)” is enabled only for the HDMI OUT 1 or 2 jack selected with “Control Select.”
- Refer to “Single HDMI cable input to TV audio with Audio Return Channel function” ([p. 131](#)) for setting instructions.

3: While the Audio Return Channel function is on, the jack selected for the input source cannot be used.

Selecting an input source to assign audio input for the TV

TV Audio Input

Select the input source that receives audio signals from TV while the HDMI Control function is on.

When the TV is set to output sounds via this unit, the TV audio input is automatically selected to the input source assigned here.  1

TV1

| | |
|-----------------|----------|
| Audio input | AUDIO1-4 |
| Default setting | AUDIO1 |

TV2

| | |
|-----------------|----------|
| Audio input | AUDIO1-4 |
| Default setting | AUDIO3 |

- “TV Audio Input” is enabled only for the HDMI OUT 1 or 2 jack selected with “Control Select.”
- Refer to “Switching the input source on this unit automatically when listening to TV audio” ([p. 130](#)) for instructions.

Specify whether or not audio signal is output through this unit and a TV connected via the HDMI OUT jack

Audio Output

Choose whether audio from an external component, such as a BD/DVD player, connected via HDMI is played back through this unit or through a TV.

Amp

Specify whether or not audio signal is output through this unit.

| | |
|--------------|--|
| Off | Audio is not output through this unit. |
| On (Default) | Audio is output through this unit. When this setting is selected, audio from the external component is output in a format compatible with this unit. |

OUT1

Specify whether or not audio signal is output through a TV connected via the HDMI OUT 1 jack.

| | |
|---------------|--|
| Off (Default) | Audio is not output through a TV connected via the HDMI OUT 1 jack. |
| On | Outputs audio through a TV connected via the HDMI OUT 1 jack. When this setting is selected, audio from the external component is output in a format compatible with the TV. |

OUT2

Specify whether or not audio signal is output through a TV connected via the HDMI OUT 2 jack.

| | |
|---------------|--|
| Off (Default) | Audio is not output through a TV connected via the HDMI OUT 2 jack. |
| On | Outputs audio through a TV connected via the HDMI OUT 2 jack. When this setting is selected, audio from the external component is output in a format compatible with the TV. |

When “HDMI Control” is set to “On,” the settings of “Amp” and the HDMI OUT jack (OUT1 or OUT2) selected with “Control Select” are interlocked with “HDMI Control.”

Transmitting HDMI audio/video to the TV during standby mode (Standby Through)

Standby Through

This function allows audio/video signals from HDMI inputs to continue to be transmitted to a TV when this unit is in standby mode.

When the Standby Through function is “On,” audio/video signals continue to be output to the TV from the last HDMI input source before this unit enters standby mode. The HDMI input source can be selected using **AV1-7** or **V-AUX** in standby mode.

| | |
|---------------|--|
| Off (Default) | Sets Standby Through to “Off.” |
| On | Transmits audio/video signals from the selected HDMI input source to the TV. |

- When “HDMI Control” is “On,” Standby Through function is automatically enabled and “Standby Through” is not displayed.
- When the Standby Through function is on, the HDMI Through/iPod Charge indicator on the front panel lights during the standby mode. This unit consumes 2 to 5 W of power.
- Input source can be selected during Standby Through.

 1: While the Audio Return Channel function is on, the jack selected for the input source cannot be used.

Adjusting this unit's network parameters

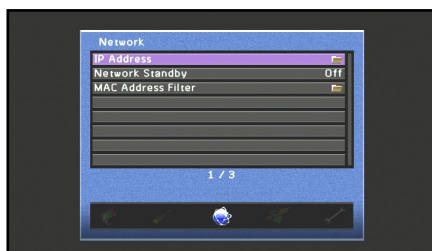

Network setup items

| | |
|--------------------|--|
| IP Address | Selects whether this unit acquires network parameters (IP address, etc.) from the network's DHCP server automatically, or whether these parameters are specified manually. |
| Network Standby | Selects whether or not commands are accepted over the network when this unit is in standby mode. |
| MAC Address Filter | Sets the MAC address filter to restrict network access to this unit. |

Specifying network parameters (IP address, etc.)

IP Address

Selects whether or not this unit automatically acquires network parameters (IP address, subnet mask, default gateway, primary DNS server and secondary DNS server) from the a network device such as a router equipped with DHCP function.

DHCP

| | |
|--------------|---|
| Off | Select this setting to specify IP address manually. |
| On (Default) | Select this setting to acquire IP address from the network's DHCP server automatically. |

Manual Setup

| | |
|---|---|
| IP Address | Specifies the IP address assigned to this unit. An IP address used by another device on the same network may not be used. |
| Subnet Mask | Specifies the subnet mask assigned to this unit. |
| Default Gateway | Specifies the IP address of the default gateway. |
| DNS Server (Primary)/DNS Server (Secondary) | Specifies the IP addresses of the primary and secondary Domain Name System (DNS) servers. |

If the network has only one DNS address, enter that address in "DNS Server (Primary)." If the network has two or more DNS addresses, enter one of the addresses in "DNS Server (Primary)" and the other in "DNS Server (Secondary)."

Turning this unit on by the command over the network when in the standby mode

Network Standby

Selects whether or not to turn this unit on by the command over the network when in the standby mode.

| | |
|---------------|--|
| Off (Default) | Disables to turn this unit on by the command over the network. |
| On | Enables to turn this unit on by the command over the network. |

When "Network Standby" is set to "On," this unit can be turned on by the command over the network during the standby mode with the power consumption of about only 5 W.

Setting the MAC Address Filter

MAC Address Filter

Sets the MAC address filter to restrict access to this unit in LAN.

Mode

| | |
|---------------|---|
| Off (Default) | Disables the MAC address filter function. |
| On | Permits access to this unit only by network devices with specified MAC addresses. |

Address Setup

Specifies the MAC addresses of network devices permitted to access to this unit when "MAC Address Filter" is set to "On."

Setting this unit's multi-zone function

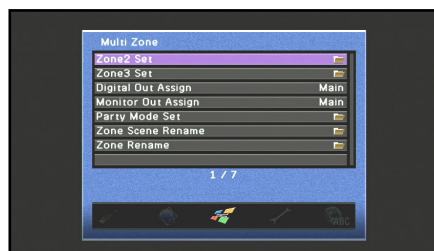

Multi Zone setup items

| | |
|--------------------|---|
| Zone2 Set | Sets the Zone2 functions. |
| Zone3 Set | Sets the Zone3 functions. |
| Digital Out Assign | Selects a zone to which the digital audio signals are output from AV OUT/ZONE4 jacks. |
| Monitor Out Assign | Displays the menus of Zone2, Zone3 or Zone4 on the TV monitor. |
| Party Mode Set | Enable or disable the party mode function. |
| Zone Scene Rename | Changes the scene names of Zone. |
| Zone Rename | Changes the name of Zone2, Zone3 or Zone4. |

Adjusting Zone2 or Zone3 volume

Zone2 Set

Zone3 Set

Volume

Selects whether or not volume level adjustment of Zone2 or Zone3 speakers is enabled.

| | |
|--------------------|--|
| Fixed | Disables volume level adjustment of Zone2 or Zone3 speakers. |
| Variable (Default) | Enables volume level adjustment of Zone2 or Zone3 speakers. |

When setting the Power Amp Assign function, "Volume" is automatically set to "Variable." Refer "Speaker layout" (p. 16) for details on the Power Amp Assign function.

Max Volume

Specify the maximum volume level in Zone2 or Zone3 so that sound is not too loud.

| | |
|-----------------------|---------------------------------------|
| Adjustable range | -30.0 dB to +16.5 dB (maximum volume) |
| Default setting | +16.5 dB |
| Adjustment increments | 5.0 dB |

Initial Volume

Specify the initial volume level in Zone2 or Zone3 when this unit is turned on.

| | |
|-----------------------|---------------------------------|
| Adjustable range | Off, Mute, -80.0 dB to +16.5 dB |
| Default setting | Off |
| Adjustment increments | 0.5 dB |

Mono

Switches between stereo and monaural modes for Zone2 or Zone3 audio signal.

| | |
|---------------|---|
| Off (Default) | Does not convert Zone2 or Zone3 audio signal to monaural sound. |
| On | Converts Zone2 or Zone3 audio signal to monaural sound. |

Selecting the zone for optical output signal

Digital Out Assign

Selects main zone or Zone4 to which the optical audio signals are output from AV OUT/ZONE4 jacks.



| | |
|-------|---|
| Main | Outputs the optical signals to the main zone. |
| Zone4 | Outputs the optical signals to Zone4. |



■ Displaying the video on the TV monitor in Zone2, Zone3 or Zone4

Monitor Out Assign

Sets the component video, S-video or video (HDMI OUT/ZONE OUT) jacks for the main zone, Zone2, Zone3 or Zone4 use. When using one of HDMI OUT jacks to connect to the TV monitor in the main zone, jacks of MON.OUT can be used for another monitor for Zone2, Zone3 or Zone4.

| | |
|---|--|
| Main (Default) | Outputs the video signals of the main zone operation status. |
| Zone2  1 | Outputs the video signals for Zone2. |
| Zone3  1 | Outputs the video signals for Zone3. |
| Zone4 | Outputs the video signals for Zone4. |

■ Setting the party mode

Party Mode Set

In party mode, the main zone sources can be played in Zone2, Zone3 and Zone4 simultaneously ([p. 136](#)). The party mode function can be enabled or disabled individually for Zone2, Zone3 and Zone4.

Target : Zone2

| | |
|------------------|--|
| Disable | Disables the party mode function in Zone2. |
| Enable (Default) | Enables the party mode function in Zone2. |

Target : Zone3

| | |
|------------------|--|
| Disable | Disables the party mode function in Zone3. |
| Enable (Default) | Enables the party mode function in Zone3. |

Target : Zone4

| | |
|------------------|--|
| Disable | Disables the party mode function in Zone4. |
| Enable (Default) | Enables the party mode function in Zone4. |

 1 : The Option menu and content window can be displayed on the monitor for Zone2 and Zone3. For details on features of Zone OSD, refer to “Features of the Zone2/Zone3 OSD” ([p. 134](#)).

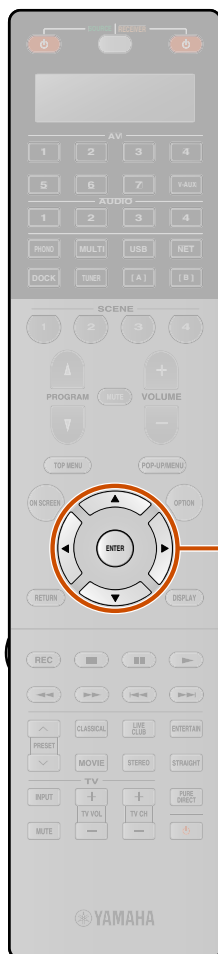

Changing Zone2, Zone3 and Zone4 SCENE names

Zone Scene Rename

Editing the name of the selected scene in Zone2, Zone3 or Zone4.

- 1 Use **[9]Cursor Δ / ▽** repeatedly to select “Zone Scene Rename” and press **[9]ENTER**.
- 2 Press **[9]Cursor Δ / ▽** to select a zone and press **[9]ENTER**.
- 3 Press **[9]Cursor Δ / ▽** to select a scene you want to rename and press **[9]ENTER**.

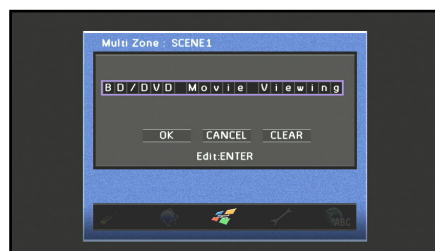

- 4 Press **[9]ENTER**.
Editing the name is available.
- 5 Press **[9]Cursor Δ / ▽** to select a character, and press **[9]Cursor </>** to enter the selected character.
- 6 Repeat step 5 to enter the desired scene name.
- 7 Confirm the zone name by pressing **[9]ENTER**.

- 8 Press **[9]Cursor ▽** to select “OK” and press **[9]ENTER** to register the new scene name.

- To cancel the operation without applying changes, select “CANCEL” and press **[9]ENTER**.
- To clear the characters entered in step 5, select “CLEAR” and press **[9]ENTER**.
- Scene names may consist of up to 20 characters.

Changing Zone names

Zone Rename

Editing the name of the selected zone.

- 1 Use **[9]Cursor Δ / ▽** repeatedly to select “Zone Rename” and press **[9]ENTER**.
- 2 Press **[9]Cursor Δ / ▽** to select a zone you want to rename and press **[9]ENTER**.

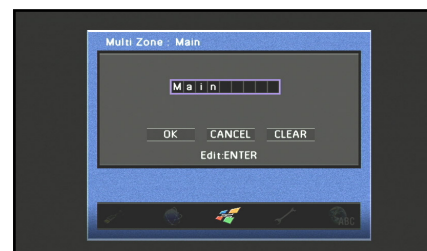

- 3 Press **[9]ENTER**.
Editing the name is available.
- 4 Press **[9]Cursor Δ / ▽** to select a character and press **[9]Cursor </>** to enter the selected character.
- 5 Repeat step 4 to enter the desired zone name.

- 6 Confirm the zone name by pressing **[9]ENTER**.
- 7 Press **[9]Cursor ▽** to select “OK” and press **[9]ENTER** to register the new zone name.

- To cancel the operation without applying changes, select “CANCEL” and press **[9]ENTER**.
- To clear the characters entered in step 4, select “CLEAR” and press **[9]ENTER**.
- Zone names may consist of up to 9 characters.

Making the receiver easier to use



Function setup items

| | |
|------------------|--|
| Auto Power Down | This unit enters standby mode if no operations are performed. |
| Input Assignment | Assigns the input jack to the selected input source. |
| Display Set | Specifies menu items displayed on TV screen and the front panel. |
| Trigger Output1 | Specifies TRIGGER OUT 1 jack function. |
| Trigger Output2 | Specifies TRIGGER OUT 2 jack function. |
| Memory Guard | Protects some settings against accidental modification. |



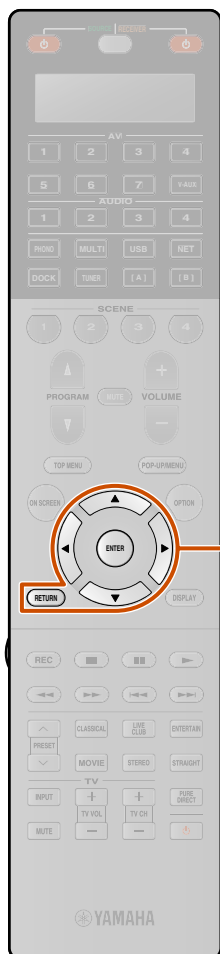

Entering standby mode automatically when no operations are performed

Auto Power Down

If you do not operate this unit or use the remote control for an extended period of time, it will automatically go into standby mode (Auto Power Down function). This function's default setting is "Off." When you want to enable this function, set the amount of time to pass before this unit will enter standby.

| | |
|---------------|--|
| 4Hours | Goes into standby mode, when you have not operated this unit for four hours. |
| 8Hours | Goes into standby mode, when you have not operated this unit for eight hours. |
| 12Hours | Goes into standby mode, when you have not operated this unit for twelve hours. |
| Off (Default) | Auto Power Down function is disabled. |

This unit starts a countdown of 30 seconds before entering the standby mode. Pressing any key of the remote control during the countdown cancels entering the standby mode and reset the timer.

Assigning component input and output jacks

Input Assignment

Assigns the coaxial or optical input jack(s) to the selected input source when this unit's initial settings do not correspond to your needs. Change the parameter to reassign the respective jacks and effectively connect more components.

Once the input jacks are reassigned, the corresponding component can be selected using the Input selector buttons.

Example: Assigning the OPTICAL input jack to "AV1."

1 Press **[ENTER]** to display the "Input Assignment" screen.

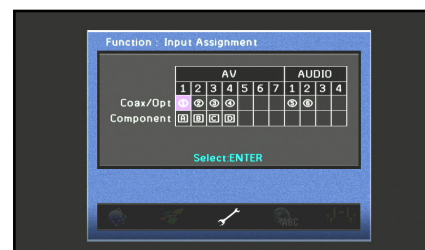

2 Press **[Cursor Δ / ▽ / < / >]** to select the cell at the intersection with the "AV1" and "Coax/Opt" and then press **[ENTER]**.

3 Press **[Cursor < / >]** to select "3" and then press **[ENTER]**.

Select "None" to clear the existing assignment.

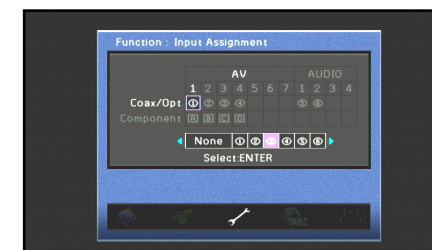

The choices indicate the following jacks.

①, ②, ⑥ : COAXIAL jacks

③, ④, ⑤ : OPTICAL jacks

[A], [B], [C], [D] : COMPONENT VIDEO jacks

The choices indicate the jacks marked the same alphanumeric on the rear of this unit. For details on marks on the rear of this unit, refer to "Rear panel" (p. 10).

4 Press **[RETURN]** to apply change and return to the previous screen.

- A specific item cannot be selected more than once for the same type of jack.
- Only component, coaxial and optical jacks can be reassigned.
- Coaxial and optical jacks cannot be assigned to the input at the same time.

■ Specifying menu display

Display Set

Specify front panel display brightness and TV screen wall paper.

Front Panel Display

Specify front panel display brightness and message scroll pattern.

| | |
|--------|---|
| Dimmer | Adjustable range: -4 - 0 Reduce brightness of the front panel display. As the value is lowered, the panel display darkens. |
| Scroll | Selects the manner in which display scrolls when the total number of characters exceeds the display area on the front panel display. Select "Continue" for continuous scrolling of all characters. Select "Once" to scroll through all characters once and then halt scrolling for display of only the first 14 characters. |

Wall Paper

Specify the wall paper displayed on the TV screen when no video signal is input. Select one that you prefer.

| | |
|-------------|--|
| Picture 1-3 | Displays an image on the TV screen when there is no video signal. |
| Gray | Displays a gray background on the TV screen when there is no video signal. |

■ Setting TRIGGER OUT functions

Trigger Output1

Trigger Output2

Synchronizes TRIGGER OUT 1 or 2 jack function with the power status of each zone or input switching.

Trigger Mode

Specify timing of electronic signal transmission to the TRIGGER OUT 1 or 2 jack.

| | |
|-----------------|---|
| Power (Default) | TRIGGER OUT 1 or 2 jack function is synchronized with the power status of the zone specified with "Target Zone." |
| Source | TRIGGER OUT 1 or 2 jack function is synchronized with input switching in the zone specified with "Target Zone." Electronic signal is transmitted according to the "Target Source" setting. |
| Manual | Select this to manually switch the output level for electronic signal transmission with "Manual." |

Target Zone



Specify the zone with which TRIGGER OUT 1 or 2 jack function is synchronized.

| | |
|---------------|--|
| Main | When "Trigger Mode" is set to "Power," electronic signal transmission is synchronized with the power status of the main zone. When "Trigger Mode" is set to "Source," electronic signal transmission is synchronized with input switching in the main zone. |
| Zone2 | When "Trigger Mode" is set to "Power," electronic signal transmission is synchronized with the power status of Zone2. When "Trigger Mode" is set to "Source," electronic signal transmission is synchronized with input switching in Zone2. |
| Zone3 | When "Trigger Mode" is set to "Power," electronic signal transmission is synchronized with the power status of Zone3. When "Trigger Mode" is set to "Source," electronic signal transmission is synchronized with input switching in Zone3. |
| Zone4 | When "Trigger Mode" is set to "Power," electronic signal transmission is synchronized with the power status of Zone4. When "Trigger Mode" is set to "Source," electronic signal transmission is synchronized with input switching in Zone4. |
| All (Default) | When "Trigger Mode" is set to "Power," electronic signal transmission is synchronized with the power status of the main zone or Zone2, Zone3 or Zone4. When "Trigger Mode" is set to "Source," electronic signal transmission is synchronized with input switching in the main zone or Zone2, Zone3 or Zone4. |



Target Source



Specify the output level of electronic signal transmitted each time input is switched.

| | |
|--|---|
| Low  | Terminates electronic signal transmission when the input source specified with this option is selected. |
| High (Default)  | Electronic signal is transmitted when the input source specified with this option is selected. |

This setting is available only when “Trigger Mode” is set to “Source.”

Manual

Manually switch the output level for electronic signal transmission. This setting can also be used to confirm proper function of the external component connected via the TRIGGER OUT 1 or 2 jack.

| | |
|--|---|
| Low  | Stops the electronic signal transmission. |
| High (Default)  | Transmits the electronic signal. |

This setting is available only when “Trigger Mode” is set to “Manual.”

Prohibiting setting changes

Memory Guard

Prohibits setting changes to prevent careless changes being made to the settings on Setup menu.

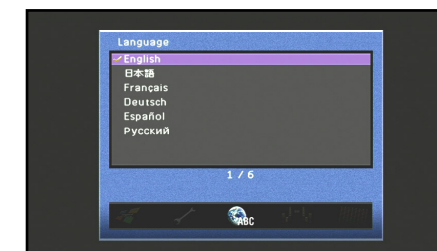

| | |
|---------------|--|
| Off (Default) | Settings are not protected. |
| On | Prohibits changes to the settings on Setup menu until it is returned to “Off.” While set to “On,” the unit displays “Memory Guard!” when an attempt is made to change the settings. |

Language



Select the language used for display of menus and messages.  Choices: English (English), 日本語 (Japanese), Français (French), Deutsch (German), Español (Spanish), Русский (Russian)

For details on selecting a language, refer to “Language selection” ([p. 2](#)).

-  1: This unit outputs 0 V when selecting “Low.”
-  2: This unit outputs 12 V when selecting “High.”
-  3: Content window information is displayed in the language in which that information was released.

Confirming information of this unit (Information menu)

A variety of information for this unit can be displayed.

Selecting information

1 Press **[8] ON SCREEN**.

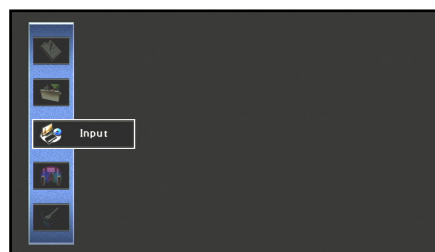

2 Use **[9] Cursor Δ / ∇** to select "Information" and press **[9] ENTER**.

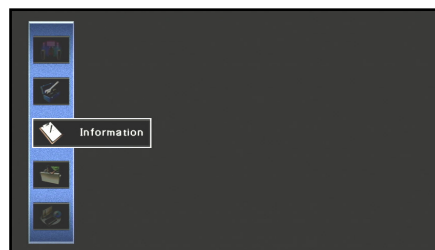

3 Use **[9] Cursor \leftarrow / \rightarrow** to select an Information menu and press **[9] ENTER**.



Audio Signal information

Displays information on the current audio signal.

| | |
|----------|---|
| Format | Signal format. When this unit is unable to detect a digital signal, it automatically switches to analog input. |
| Sampling | The number of samples taken per second from a continuous signal to make a discrete signal. |
| Channel | The number of source channels in the input signal (front/surround/LFE). For example, a multi-channel soundtrack with 3 front channels, 2 surround channels and LFE is displayed as "3/2/0.1". |
| Bitrate | The number of bits passing a given point per second. |
| Dialogue | The dialogue normalization level preset to the current input bitstream signal. |

- "—" is displayed when this unit cannot display the corresponding information.
- Some high-definition audio bitstream contents may not include the discrete surround back left and right channel signals, but are encoded at a sampling rate of 192 kHz.
- Even when direct bitstream output settings are applied, some players convert the Dolby TrueHD or Dolby Digital Plus bitstreams to the Dolby Digital bitstreams, while converting DTS-HD Master Audio or DTS-HD High Resolution Audio bitstreams to DTS bitstreams.

Video Signal information

Displays information on the current video signal.

| | |
|-------------------|---|
| HDMI Signal | Source video signal type and video signal output to this unit's HDMI OUT 1-2 jacks. |
| HDMI Resolution | Input signal (analog or HDMI) and output signal (HDMI) resolution. |
| Analog Resolution | Resolution of the source video signal and the analog video signal output to this unit's MONITOR OUT jacks. |
| HDMI Error | Error message for HDMI sources or connected HDMI devices (see p. 137). This information is displayed only when the error come up. |

HDMI Monitor information

Displays information on the TV screen connected to this unit's HDMI OUT 1-2 jacks.

| | |
|------------------|---|
| Interface | Displays information on the current connection interface. |
| Video Resolution | Displays the frequency for each video resolution of the TV currently connected. |



Network information

Displays information on the network status. Refer to “Adjusting this unit’s network parameters” (p. 106) for details on setting the network status.

| | |
|--|--|
| IP Address / Subnet Mask / Default Gateway | Displays the status of the current IP address assigned to this unit. |
| DNS Server (P) / DNS Server (S) | Displays the IP address of the primary and secondary DNS (Domain Name System) servers. |
| MAC Address | Displays the MAC address filter set to this unit. |
| Status | Displays the network status of this unit. |

System information

Displays information on the current settings of the advanced setup.

| | |
|-------------------|--|
| Remote ID | Displays the Remote ID set to this unit. |
| TV Format | Displays the TV format set to this unit. |
| Speaker Impedance | Displays the speaker impedance set to this unit. |
| System ID | Displays the system ID of this unit. |
| Firmware Version | Displays the current version of the firmware installed to this unit. |

When detecting the latest firmware over a network:

- exclamation point appears on the Information menu icon
- message indicating that the latest firmware is released appears in the System information

In this case, update the latest firmware by using “NETWORK” of “FIRM UPDATE” in Advanced Setup menu.

Zone information

Displays information on the currently selected input and the volume of Zone2, Zone3 or Zone4.

Controlling the remote control to operate various functions

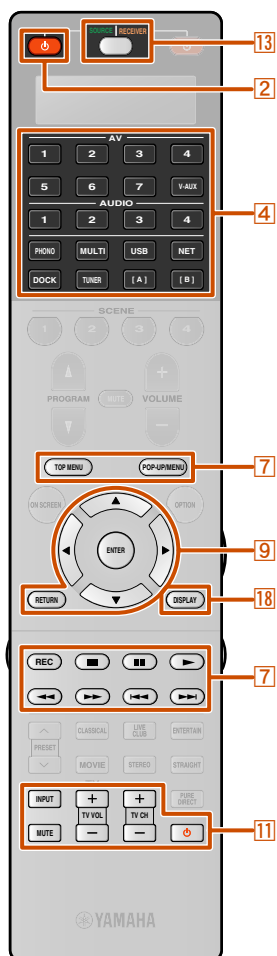

You can operate an external component such as TV and DVD player with the remote control of this unit by setting the code for external component (remote control code). The remote control code can be set for each input source. Individual setting allows you to switch external components seamlessly depending on the selected input source.

Selecting input source connected to DVD player

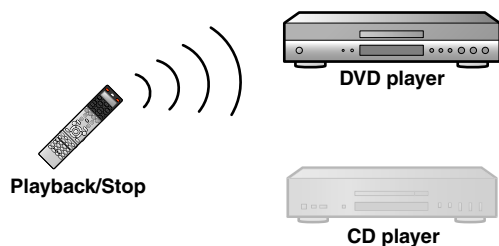

Selecting input source connected to CD player

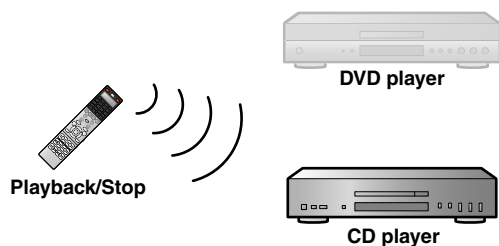

13 SOURCE/RECEIVER glows orange when operation of this unit is enabled.

13 SOURCE/RECEIVER glows green when operation of an external component is enabled.

Keys connecting external components

The remote control keys for controlling external components are available only when the external components have corresponding control keys.

2 SOURCE

Switches an external component on and off.

7 External component operation keys

Functions as a recording or playback key of an external component, or a menu display key.

9 Cursor, 9 ENTER, 9 RETURN

Operates the menus of external components.

11 TV control keys

| | |
|----------------------|------------------------------|
| 11 INPUT | Switches video inputs of TV. |
| 11 MUTE | Mutes TV volume temporarily. |
| 11 TV VOL +/- | Controls the volume of TV. |
| 11 TV CH +/- | Switches TV channels. |
| 11 | Turns on and off TV. |

18 DISPLAY

Switches an external component display.

22 Numeric keys

Functions as numeric keys of an external component.

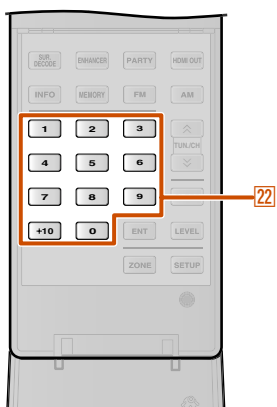

- 1 : When remote control codes for external components are registered with **4 Input selector** or **11** (**11 TV control keys**), the following operations are possible.
- When a TV remote control code is registered with **4 Input selector**, **7 TOP MENU**, **7 POP-UP MENU**, **9 Cursor**, **18 DISPLAY**, **22 Numeric keys** and **11 TV control keys** can be used to control the TV selected with **4 Input selector**.
 - When a TV remote control code for a device other than a TV is registered with **4 Input selector**, keys including the **9 Cursor**, **7 TOP MENU**, **7 POP-UP MENU**, **18 DISPLAY** and **22 Numeric keys** can be used to control external components, and the **11 TV control keys** can be used to control the TV registered with **11** .
 - When a TV remote control code is registered with **11** , only **11 TV control keys** can be used to control the TV.

- When a TV remote control code for a device other than a TV is registered with **4 Input selector**, keys including the **9 Cursor**, **7 TOP MENU**, **7 POP-UP MENU**, **18 DISPLAY** and **22 Numeric keys** can be used to control external components, and the **11 TV control keys** can be used to control the TV registered with **11** .
- When a TV remote control code is registered with **11** , only **11 TV control keys** can be used to control the TV.



Customizing the remote control

Use the setup mode of the remote control to customize the remote control.

1 Open the cover of remote control and press **[28] SETUP**.

“SETUP” appears in the display window on the remote control.

2 Press **[9] Cursor Δ / ▽** repeatedly to select the desired setup mode.

Pressing **[13] SOURCE/RECEIVER** repeatedly can also change the setup mode.

| Setup mode | Descriptions | Page |
|------------|---|---------------------|
| SETUP | Top setup mode menu. | — |
| LEARN | Learning mode. Use this feature to program codes from other remote controls. | 118 |
| PRESET | Preset mode. Use this feature to change the remote control code of each control area. | 117 |
| RENAME | Renaming mode. Use this feature to change the name of each control area. | 120 |
| MACRO | Macro programming mode. Use this feature to set the macro program. | 121 |
| CLEAR | Clearing mode. Use this feature to clear the configurations of this unit. | 122 |

| Setup mode | Descriptions | Page |
|------------|---|---------------------|
| ERASE | Erase mode. Use this feature to erase the learned functions of each button. | 123 |
| EX-IR | Extended IR code mode. This feature is for the authorized custom installers only. | — |

3 After the configurations, press **[28] SETUP** again to exit from the setup menu.

NOTE

If no operation is performed for 30 seconds, this unit automatically exits from the setup menu.

Setting remote control codes

Default remote control code settings

The following remote control codes are assigned to input sources at factory default settings. For a complete list of available remote control codes, refer to “[Remote Control Code Search](#)” in the CD-ROM.

| Control area | Category | Manufacturer | Remote control code |
|--------------|-------------------------|--------------|---------------------|
| AV1 | Blu-ray player/recorder | Yamaha | 2064 |
| AV2 | — | — | — |
| AV3 | — | — | — |
| AV4 | — | — | — |

| Control area | Category | Manufacturer | Remote control code |
|---|-----------|--------------|---------------------|
| AV5 | — | — | — |
| AV6 | — | — | — |
| AV7 | — | — | — |
| V-AUX | — | — | — |
| AUDIO1 | — | — | — |
| AUDIO2 | CD player | Yamaha | 5095 |
| AUDIO3 | — | — | — |
| AUDIO4 | — | — | — |
| PHONO | — | — | — |
| MULTI | — | — | — |
| USB | — | — | — |
| NET | — | — | — |
| DOCK | — | — | — |
| TUNER | — | — | — |
| [A]/[B]  1 | — | — | — |

NOTES

- You may not be able to operate your Yamaha component even if a Yamaha remote control code is preset as listed above. In this case, try setting another Yamaha remote control code.
- If this unit’s remote control is unable to control other components with specification of the corresponding remote control code, it can be programmed using other remote controls ([p. 118](#)).

 1: Use [A]/[B] for external component operations only. Set these keys to remote control codes if you want to perform external component operations without linking to input source selection of this unit. For example, it may be convenient to assign remote control codes for devices such as TVs.

■ Registering remote control codes for external component operations

The following section describes how to register remote control code using an example of the registration of the remote control codes of a Yamaha BD player connected to AV2 jack.

- Perform each of the following steps within 30 seconds. Settings will be automatically stopped if more than 30 seconds passes since the last operation. To reset, repeat from step 2.
- Remote control code of an external component cannot be set from the name or model number of a unit. Use “Remote Control Code Search” in the CD-ROM to search the available remote control codes from the category or manufacturer of external components.
- If multiple remote control codes exist, first set the first code in the list, if it does not work then try the other codes.

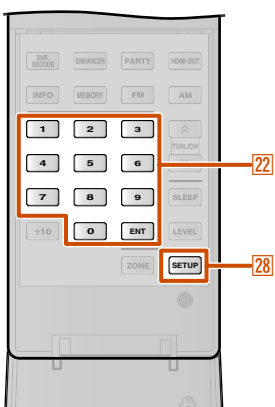
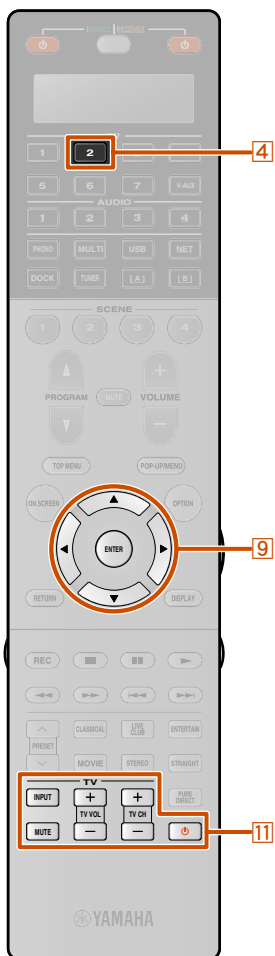

1 Use “Remote Control Code Search” in the CD-ROM to search the available remote control codes from the category or manufacturer of external components.

“2064” can be used for a Yamaha BD player.

2 Press **28** **SETUP**. “SETUP” appears in the display window on the remote control.



3 Press **9** **Cursor** Δ / ∇ repeatedly to select “PRESET” and press **9** **ENTER**. **1**

The remote control enters the preset mode. “PRESET” and name of the currently selected control area appears in the display window alternately.



4 Press **4** **AV2** to switch the input source to AV2. **2**

Perform the following steps to register the selected input source here to the remote control code.



5 Press **9** **ENTER**. The current code setting appears.



6 Enter a remote control code “2064” using **22** **Numeric keys**.

A remote control code can be entered using **9** **Cursor** Δ / ∇ / \leftarrow / \rightarrow .



Continues to the next page

1 : **22** **ENT** can also be used for remote control settings as well as **9** **ENTER**.

2 : To control a TV with **11** **TV control keys** independently from the input source, press **11** **TV** in step 4 and enter the remote control code for the TV. You can control that TV with **11** **TV control keys** regardless of the input source selection.

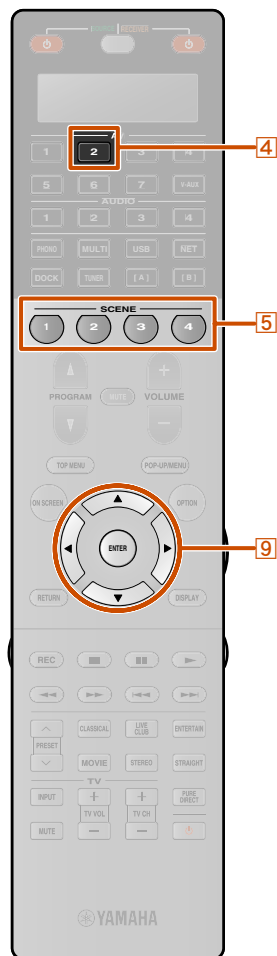

7 Press [9]ENTER to set the number.
 “OK” appears in the display window if setting was successful.
 “NG” appears in the display window if the setting was unsuccessful. In this case, start over from step 3.



If you continuously want to set up another code for another control area, repeat steps 4 to 7.

8 Press [28]SETUP again to exit from the setup menu.
 If operation is not possible and the manufacturer of your component has more than one code, try each of them until you find the correct one.

NOTES

- “ERROR” appears in the display window on the remote control if you press a button not indicated in the respective step, or when you press more than one button simultaneously.
- The supplied remote control does not contain all possible codes for commercially available audio and video components (including Yamaha components). If operation is not possible with any of the remote control codes, program the new remote control function using the learning feature (p. 118) or use the remote control supplied with the component.
- Functions programmed using the learning mode take priority over remote control code functions.

Switching between BD player linked to scene selections

Press [5]SCENE and at the same time press [4]AV2 and hold it for approximately 3 seconds.
 “OK” appears in the display window if setting was successful.



Then you can operate the external components by switching the input source to AV2, or selecting AV2 in the registered scene.

Same steps for operating other external components, press [5]SCENE and at the same time press the input source key selected in step 3 and hold it for approximately 3 seconds.

Programming from other remote controls

The remote control of this unit can receive remote control signals from other remote controls and learn the remote control operation. If a key on the remote control does not work after being assigned with an external component’s function or if the remote control code for that function is not provided, use this learning feature to make the function operable with the remote control.

- Perform each of the following steps within 30 seconds. Settings will be automatically stopped if more than 30 seconds passes since the last operation. To reset, repeat from step 1.
- If the remote control of the external component uses infrared rays, this remote control can learn most of its functions. The remote control may not recognize special or consecutive signals.
- The keys may not operate the assigned functions depending on operating conditions of this unit.

1 Press [28]SETUP.
 “SETUP” appears in the display window.

2 Press [9]Cursor Δ / ▽ repeatedly to select “LEARN” and press [9]ENTER.

Continues to the next page



3 Select the operation mode (SOURCE, RECEIVER or TV mode) for which functions will be assigned to remote control keys.

- **SELECTING THE SOURCE mode**
Press **[4] Input selector** to enter SOURCE mode.
In this mode, remote control functions for the selected input source can be assigned to this unit's remote control.
- **RECEIVER mode**
Press **[12] RECEIVER** to enter RECEIVER mode.
In this mode, remote control functions for external amplifier can be assigned to this unit's remote control.

NOTE

When remote control functions are assigned for this mode, it may be impossible to operate this unit using the remote control.

- **TV mode**
Press **[11] TV** to enter TV mode.
In this mode, remote control functions for a TV can be assigned to this unit's remote control.

Remote control functions can be assigned to this unit's remote control keys as follows.

| Mode | Keys |
|--|---|
| SOURCE | Keys for operating the external components such as [2] SOURCE , [7] External component operation keys or [9] Cursor $\Delta / \nabla / \triangleleft / \triangleright$. |
| RECEIVER | Keys for operating this unit such as [7] External component operation keys , [9] Cursor $\Delta / \nabla / \triangleleft / \triangleright$ and [22] Numeric keys . |
| TV  | [11] TV control keys |

 **1** : Once **[11] TV control keys** are set in TV mode, the TV can always be controlled.
When **[11] TV control keys** are set in SOURCE mode, the TV specified in SOURCE mode can be controlled when the input source is selected.

4 Place this remote control about 5 to 10 cm apart from the remote control of the external component on a flat surface so that their infrared transmitters are aimed at each other and then press **[9] ENTER**.

“PRES KEY” appears in the display window.

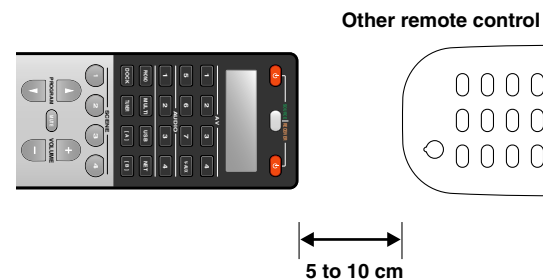

5 Press a key to which you want to assign the function.

“START” appears in the display window.



6 Press and hold the key you want to program on the other remote control until “OK” appears in the display window.

“NG” appears in the display window if learning was unsuccessful. In this case, start over from step 3.

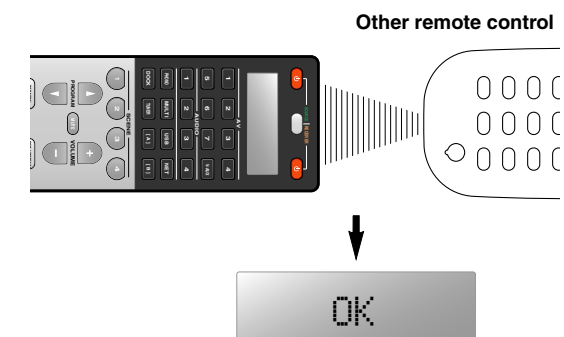

When you want to program another function, repeat steps 3 to 6.

Continues to the next page

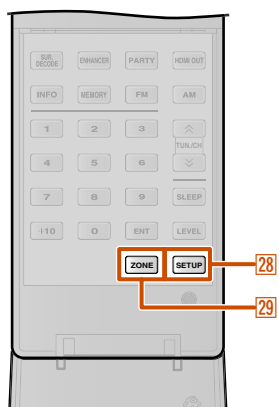
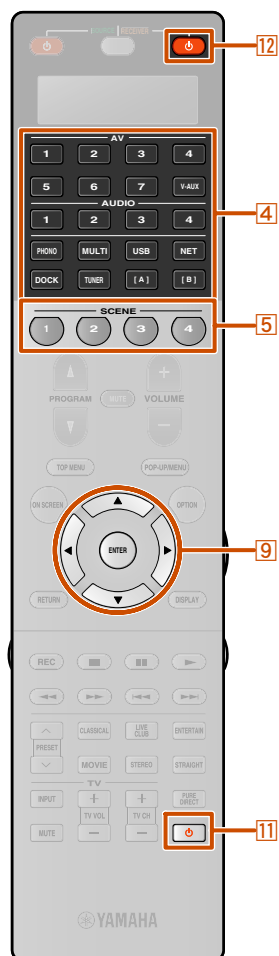

7 Press **[28]SETUP** again to exit from the setup menu.

NOTES

- “ERROR” appears in the display window on the remote control if you press a button not indicated in the respective step, or when you press more than one button simultaneously.
- This remote control can learn approximately 200 functions. However, depending on the signals learned, “FULL” may appear in the display before you program 200 functions. In this case, clear unnecessary programmed functions to make room for further learning ([p. 123](#)).
- Learning may not be possible in the following cases:
 - when the batteries in the remote control for this unit or other components are weak.
 - when the remote control is exposed to direct sunlight.
 - when the function to be programmed is continuous or uncommon.

Changing source names in the display window

The name of the control area (input source) that appears in the display window on the remote control can be changed.

- 1** Press **[28]SETUP**.
“SETUP” appears in the display window.
- 2** Press **[9]Cursor Δ / ▽** repeatedly to select “RENAME” and press **[9]ENTER**.
- 3** Press **[4]Input selector** or **[5]SCENE** to select the desired control area.
- 4** Edit the name of the control area.
To locate the position to edit, press **[9]Cursor < / >**.
To select a character, press **[9]Cursor Δ / ▽**.

Press **[9]Cursor Δ** to change the character in the following order, or press **[9]Cursor ▽** to go in the reverse order: A to Z, a to z, 0 to 9, space, symbols (-, +, /, :).

5 Press **[9]ENTER** to set the new name.
“OK” appears in the display window on the remote control if renaming was successful.

- When you want to rename the another control area, press **[4]Input selector** to select the desired control area and then press **[9]ENTER** and then carry out the operations of steps 4 to 5.
- Press **[12]RECEIVER** to rename the control area for the receiver.
- Press **[11]** to rename the control area for TV monitor.
- Press **[5]SCENE** key to rename the control area for the scenes. When rename the control area for the scenes of each zone, press **[29]ZONE** to select a zone before step 1.

6 Press **[28]SETUP** again to exit from the setup menu.

NOTE

“ERROR” appears in the display window on the remote control if you press a button not indicated in the respective step, or when you press more than one button simultaneously.



Macro programming features

The macro programming feature makes it possible to perform a series of operations with the press of a single button. For example, when you want to play a CD, normally you would turn on the components, select the CD input, and press the play button to start playback. The macro programming feature lets you perform all of these operations simply by pressing the macro button. The buttons listed as macro buttons below are factory set with macro programs. You can also program your own macros.

| Pressing macro | To automatically transmit these signals | |
|----------------|---|----------|
| | First | Second |
| RECEIVER | | — |
| AV1-7 | Turns on this unit | AV1-7 |
| V-AUX | | V-AUX |
| AUDIO1-4 | | AUDIO1-4 |
| PHONO | | PHONO |
| MULTI | | MULTI |
| USB | | USB |
| NET | | NET |
| DOCK | | DOCK |
| TUNER | | TUNER |
| [A]/[B] | | — |

Recalling programmed macro operations

1 Press **28** **SETUP**.
“SETUP” appears in the display window.

2 Press **9** **Cursor** Δ / ∇ repeatedly to select “MACRO” and press **9** **ENTER**.



3 Press **9** **Cursor** Δ / ∇ repeatedly to select “ON” and press **9** **ENTER**.
Press a macro button (**12** **RECEIVER** ϕ or **4** **Input selector**) to perform the macro operation assigned to the button.

To exit the macro operation mode, press **9** **Cursor** Δ / ∇ to select “OFF” and press **9** **ENTER**.

NOTES

- While the remote control is running a macro program (the transmission indicator flashes), it does not accept any other operation.
- Continue to aim the remote control at the component the macro is operating until the macro operation is complete.

Programing macro operations

You can program your own macro to transmit several remote control commands in sequence at the press of a button. Be sure to set up remote control codes or perform learning operations before programming the macro.

NOTE

We do not recommend that you program continuous operations (for example, volume control) in a macro.

1 Press **28** **SETUP**.
“SETUP” appears in the display window.

2 Press **9** **Cursor** Δ / ∇ repeatedly to select “MACRO” and press **9** **ENTER**.

3 Press **9** **Cursor** Δ / ∇ repeatedly to select “EDIT” and press **9** **ENTER**.

4 Press the macro button (**12** **RECEIVER** ϕ or **4** **Input selector**) that you want to assign the macro operations to.

Continues to the next page

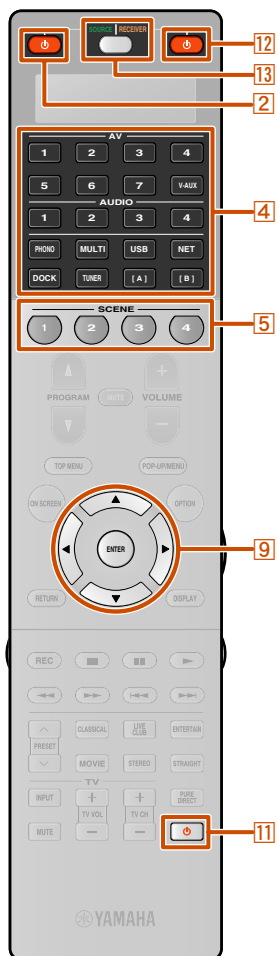

5 Press the buttons for the functions you want to include in the macro operation in sequence.

Press **13** **SOURCE/RECEIVER** to switch the controlled component.

Example

Set the input source to AV2 → Turn on the DVD player → Turn on the video monitor

Step 1 (“MACRO1”): Press **4** **AV2**.

Step 2 (“MACRO2”): Press **13** **SOURCE/RECEIVER** repeatedly to select the controlled component until MACRO2 and AV2 alternately appear in the display.

And then, press **2** **SOURCE**.

Step 3 (“MACRO3”): Press **11**.

6 Press **9** **ENTER** for 3 seconds or longer to confirm the program.

You can set up to 10 steps (10 functions). After you have set 10 steps, “FULL” appears.

7 Press **28** **SETUP** again to exit from the setup menu.

NOTE

“ERROR” appears in the display window if you press more than one button simultaneously.

Clearing configurations

Clear all changes made in each function set, such as learned functions, macros, renamed control area names and setup remote control ID.

Clearing function sets

1 Press **28** **SETUP**.

“SETUP” appears in the display window.

2 Press **9** **Cursor** Δ / ∇ repeatedly to select “CLEAR” and press **9** **ENTER**.

3 Press **9** **Cursor** Δ / ∇ repeatedly to select the operations that you want to and press **9** **ENTER**.

Operations assigned to the following modes can be cleared.

Operation modes

LEARN, PRESET, RENAME, MACRO, RESET

4 Press **4** **Input selector**, **12** **RECEIVER** ϕ or **11** ϕ to select the desired clear mode.

- “ALL” mode is set at first. When no mode is selected in this step, the settings of all modes are cleared.
- The other keys are used for the following operation modes.
 - “RENAME”: **5** **SCENE** key 
 - “MACRO”: Macro button (**12** **RECEIVER** ϕ or **4** **Input selector**)

5 Press and hold **9** **ENTER** for about 3 seconds.

When the clearing is successful, “OK” appears in the display window.

NOTES

- “NG” appears in the display window if clearing was unsuccessful.
- “ERROR” appears in the display window if you press a button not indicated in the respective step, or if you press more than one button simultaneously.

6 Press **28** **SETUP** again to exit from the setup mode.

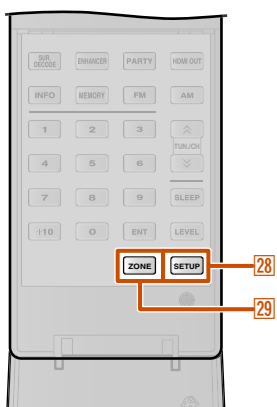

 **1**: “RESET” initializes the settings of all modes. When selecting “RESET” in step 2, you cannot select the clear mode in step 4.

 **2**: To clear the rename of each zone, press **29** **ZONE** to select the desired zone before step 1.

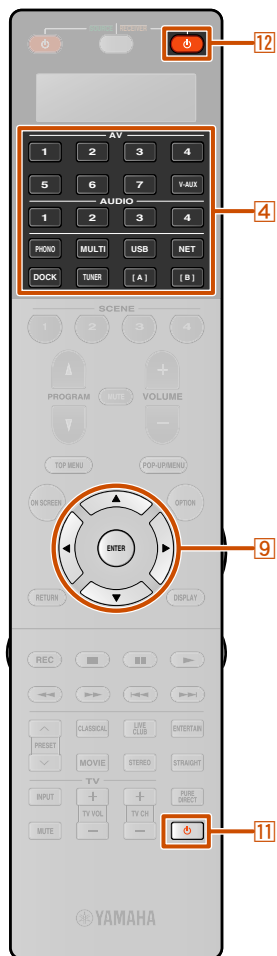

1 Clearing a function learned on each key

1 Press **28** **SETUP**.

“SETUP” appears in the display window.

2 Press **9** **Cursor** Δ / ∇ repeatedly to select “ERASE” and press **9** **ENTER**.

3 Press **4** **Input selector**, **12** **RECEIVER** \downarrow or **11** \downarrow to select the mode for which remote control key operation will be cleared.

4 Press **9** **ENTER**.

“PRES KEY” appears in the display window.

5 Press and hold the button you want to clear for about 3 seconds.

If clearing is successful, “OK” appears in the display window.

- To continue resetting other keys, repeat step 3 to 5.
- Once you clear a learned function, the button reverts to the factory setting (or to the manufacturer setting if you have set remote control codes).

6 Press **28** **SETUP** again to exit from the setup menu.

NOTES

- “NG” appears in the display window on the remote control if clearing was unsuccessful.
- “ERROR” appears in the display window if you press more than one button simultaneously.



Simplified remote control

Use the supplied simplified remote control to make basic controls of this unit.

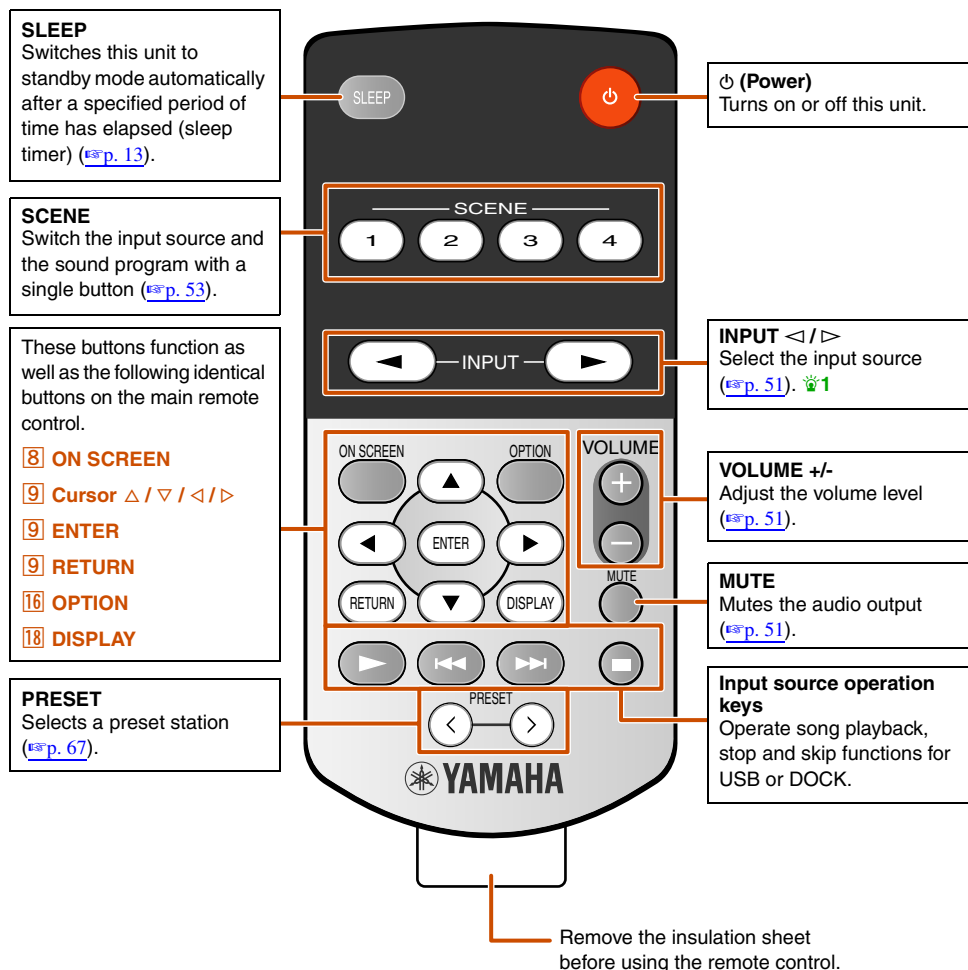

Setting the controlling zone of the simplified remote control

Use this feature to set the controlling zone (p. 135) and remote control ID (p. 126) of the simplified remote control.

Setting the remote control ID

- ID1: Press and hold \triangleleft (left cursor) and 1 for 3 seconds.
- ID2: Press and hold \triangleleft (left cursor) and 2 for 3 seconds.

Setting the controlling zone

- Main zone: Press and hold \triangleright (right cursor) and 1 for 3 seconds.
- Zone2: Press and hold \triangleright (right cursor) and 2 for 3 seconds.
- Zone3: Press and hold \triangleright (right cursor) and 3 for 3 seconds.

Replacing the battery in the simplified remote control

Change the battery when the operation range of the simplified remote control decreases.

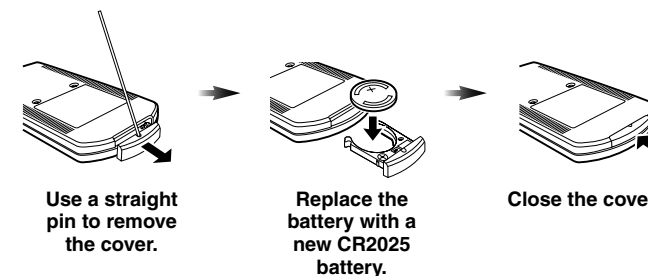

NOTES

- Insert the battery according to the polarity markings (+ and -).
- If the batteries run out, immediately remove them from the simplified remote control to prevent an explosion or acid leak.
- If a battery starts leaking, dispose of it immediately. Be careful not to let the leaking battery acid touch your skin or clothing.
- Before inserting new batteries, wipe the compartment clean.
- Dispose of batteries according to your regional regulations.

1: To select the detailed input for USB or NET (PC, NET RADIO), use PRESET or SCENE function to select the desired one.

Extended functionality that can be configured as needed (Advanced Setup menu)

The Advanced Setup menu can be used for unit initialization and other useful extended functions. The Advanced Setup menu can be operated as follows.

Displaying/Setting the Advanced Setup menu

1 Switch this unit to the standby mode.

2 Press MAIN ZONE ϕ while pressing and holding STRAIGHT on the front panel.

Release STRAIGHT when "ADVANCED SETUP" is displayed on the front panel display.

After a few seconds, the top menu items are displayed.

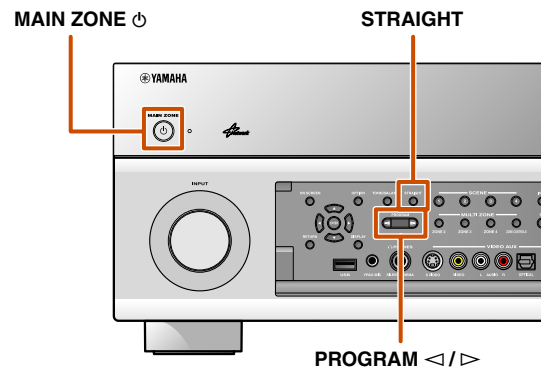

3 Press PROGRAM $\triangleleft/\triangleright$ repeatedly to select the item to be set from the following items.

In the Advanced Setup menu, you can set the following settings.

| | |
|----------------|--|
| SPEAKER IMP. | Sets the impedance of speakers. |
| REMOTE SENSOR | Activate or deactivate the signal-receiving capability of the remote control sensor. |
| REMOTE CON AMP | Changes the remote control ID of a receiver. |
| TV FORMAT | Specifies the TV's color encoding format. |
| MONITOR CHECK | Removes the up-scaling limitation on HDMI video output. |
| RECOV./BACKUP | Save and restore the settings of this unit. |
| INITIALIZE | Initializes various settings for this unit. |
| FIRM UPDATE | Update the firmware of this unit. |
| VERSION | Check the version of firmware currently installed on this unit. |

4 Press STRAIGHT repeatedly to select the value you want to change.

5 Switch this unit to the standby mode, and then switch it on again.

The settings become effective and the unit is powered on.

Setting the impedance of speakers



Changes the unit settings depending on the impedance of the speakers connected. 1

| | |
|-----------------|---|
| 6ΩMIN | Select the impedance when 6 Ω speakers are connected. |
| 8ΩMIN (Default) | Select the impedance when speakers above 8 Ω are connected. |

1 : For detailed procedures of speaker impedance settings, refer to "Changing speaker impedance" ([p. 21](#)).

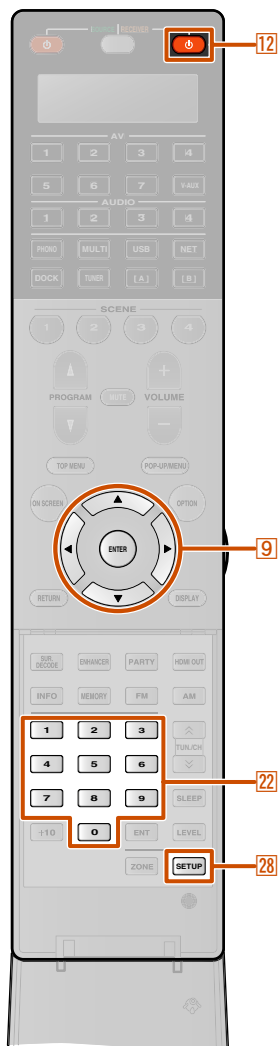

Remote sensor



Activate or deactivate the signal-receiving capability of the remote control sensor on the front panel of this unit.

| | |
|--------------|---|
| ON (Default) | Activate the signal-receiving capability of the remote control sensor |
| OFF | Deactivate the signal-receiving capability of the remote control sensor |

“ON” is recommended in most cases.

Avoiding crossing remote control signals when using multiple Yamaha receivers



The remote control of the unit can only receive signals from a receiver which has an identical ID (remote control ID). When using multiple Yamaha AV receivers, you can set each remote control with a unique remote control ID for its corresponding receiver.

On the contrary, if you are setting the same remote control ID for all receivers, you can use one remote control to operate 2 receivers.

| | |
|---------------|---|
| ID1 (Default) | Receives the remote control signals set in ID1. |
| ID2 | Receives the remote control signals set in ID2. |

ID1 is set for both remote control and receiver by default. To avoid crossing remote control, change the remote control ID for both remote control and receiver.

■ To change the remote control ID

Perform each of the following steps within 30 seconds. Settings will be automatically stopped if more than 30 seconds passes since the last operation. To reset, repeat from step 1.

- 1 Press **28** **SETUP**.
- 2 Press **9** **Cursor** Δ / ∇ repeatedly to select “PRESET” and press **9** **ENTER**.
- 3 Press **12** **RECEIVER** \downarrow and press **9** **ENTER**.
- 4 Enter the desired remote control ID code.
To switch to ID1:
Enter “5019” using **22** **Numeric keys** or **9** **Cursor** Δ / ∇ / \triangleleft / \triangleright .
To switch to ID2:
Enter “5020” using **22** **Numeric keys** or **9** **Cursor** Δ / ∇ / \triangleleft / \triangleright .
- 5 Press **9** **ENTER** to set the number.
“OK” appears in the display window if setting was successful.
“NG” appears in the display window if the setting was unsuccessful. In this case, start over from step 4.
- 6 Press **28** **SETUP** again to exit from the setup menu.

Returns to ID1 after the remote control code is initialized (see p. 122).

Changing TV format



Change the color encoding format of OSD to PAL (default) or NTSC, to match the format used by the TV connected via the HDMI OUT 1-2 or VIDEO (MONITOR OUT) jack.

Removing HDMI video output up-scaling limits



Removes the up-scaling limitation on video resolution when this unit and a TV are connected via HDMI jacks. If a resolution supported by the monitor cannot be detected when configuring the up-scaling settings, this setting will remove the output limitation.

| | |
|---------------|--|
| YES (Default) | Video output signals of a resolution not supported by the TV will not be transmitted. |
| SKIP | This unit ignores the TV's support capability and transmits input video signals to the TV. |

Recovery and backup of the system settings



Save and restore the settings of this unit.

- 1 Press **STRAIGHT** repeatedly to select "BACKUP" or "RECOVERY" and press **INFO** on the front panel.

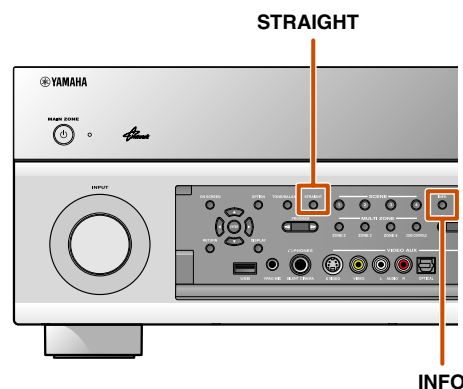

| | |
|----------|---|
| RECOVERY | Restores settings for this unit that have been saved. |
| BACKUP | Saves the current settings of this unit. |

- 2 Press **INFO** to perform the "BACKUP" or "RECOVERY." 1

"RECOVERY" cannot be selected if settings have not be previously saved.

Initializing various settings for this unit



Initializes various settings stored in this unit and sets it back to default.

Select the items to be initialized from the following.

| | |
|------------------|---|
| DSP PARAM | Initializes all parameters for the sound programs. |
| VIDEO | Resets video conversion settings (resolution/aspect ratio) in the Setup menu. |
| NETWORK | Resets the settings of network such as IP address or the account of vTuner. |
| ALL | Resets this unit to default factory settings. |
| CANCEL (Default) | Does not initialize. |

When an option other than CANCEL is selected, the applicable default settings will be restored when the unit switches to standby mode.

1 : After performing "RECOVERY," turn off this unit.

Firmware update



Update the firmware of this unit. For details on updating the firmware, refer to information supplied with updates. When this unit detects the latest firmware over a network, the message indicating that the firmware is released is displayed in the System information (p. 114).

1 Press STRAIGHT repeatedly to select “USB” or “NETWORK.”

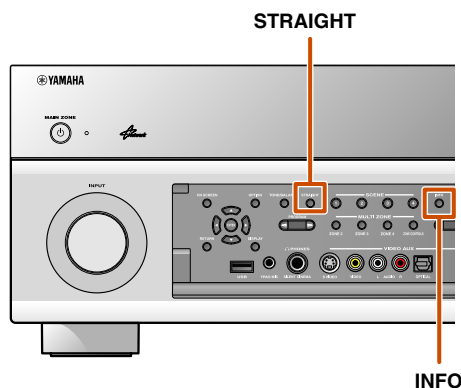

| | |
|---------------|--|
| USB (Default) | Updates the firmware of this unit using a USB flash drive. |
| NETWORK | Updates the firmware of this unit over a network. |

2 Press INFO to start update with the selected option.

- Do not use this feature unless the firmware must be updated.
- Be sure to read the information supplied with updates before updating firmware.

Firmware version



Check the version of firmware currently installed on this unit.

About the latest firmware

When installing the latest firmware, the new functions or fix of failure may be served.

- The latest firmware can be downloaded from our website.
- While displaying the ON SCREEN menu or “System” from Information menu, the information on the latest firmware is displayed via a network.

Using the HDMI Control function

This unit supports the HDMI Control function, which allows you to operate external components via HDMI. If devices that support HDMI Control (e.g., Panasonic VIERA Link-compatible TVs, DVD/Blu-ray Disc players, etc.) are connected 1, remote controls for those devices can be used to perform the following operations:

- Power synchronization (on/standby)
- Volume control, including Mute
- Changing the volume of the audio output signal device (either the TV or this unit)

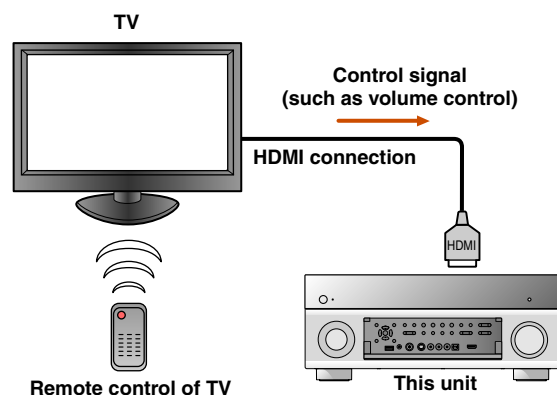

NOTE

The following is an example of how to connect this unit, a TV, and a DVD/BD player. Follow the instructions in your TV and DVD/BD player manuals, as well as the ones written below.

- Set the TV's HDMI Control function to "On"
- Follow the AV amplifier connection instructions, and connect this unit to the TV

1 Connect the TV that supports the HDMI Control function to this unit's HDMI output jack.

2 Connect the DVD/BD player that supports the HDMI Control function to this unit's HDMI input jack.

3 Turn on the TV and this unit.

Refer to the TV's instruction manual on how to operate external components.

4 Set the TV and this unit's HDMI Control function to "On."

| | |
|-----------------------------|--|
| This unit | Confirm that "HDMI Control" is set to "On" (e.g., p. 104) and select the HDMI OUT jack connected to the TV in "Control Select" (e.g., p. 104).  2 |
| TV and DVD/BD player | Check the instruction manuals for those devices. |

5 Turn the TV off.

Other synchronized HDMI Control devices are turned off with the TV. If they are not synchronized, unplug the power cable of the TV.

6 Turn the TV on.

Confirm that this unit has turned on in conjunction with the TV. If it is still off, turn it on manually.

7 Change the TV's input setting to the input jack that is connected to this unit (e.g., AV1).

8 If DVD/BD player that supports the HDMI Control function are connected to this unit, turn them on.

| | |
|-----------------------------|--|
| This unit | Confirm that the input source for the DVD/BD players has been selected. If a different input source has been selected, change it manually. |
| TV and DVD/BD player | Confirm that the video signal from the player is being properly received by the TV. |

Operations 1-8 will not be required more than twice. However, perform operations 1-8 again when switching the HDMI OUT jack using Control Select.

9 Confirm that this unit is properly synchronized with the TV through the following operations by using the TV remote control.

- Power On/Off
- Volume Control
- Switching between audio output devices

If this unit is not synchronized to the TV's power operations, check that the HDMI Control function is set to "On" for both devices.

If they will not properly synchronize, unplugging and re-plugging the power cable of this unit and the TV may solve the problem.

 1: We recommend that you use TVs and DVD/BD players from the same manufacturer whenever possible.

 2: The default setting for the HDMI Control function is "Off."

Switching the input source on this unit automatically when listening to TV audio

When the HDMI Control (esp. p. 129) is operating properly, the input source of this unit is automatically changed to match operations carried out on the TV. When the TV is connected with HDMI OUT 1, the default input jack is AUDIO1. If the AUDIO1 optical digital jack is connected to the TV's audio output jack, then you can enjoy TV sound through this unit right away.

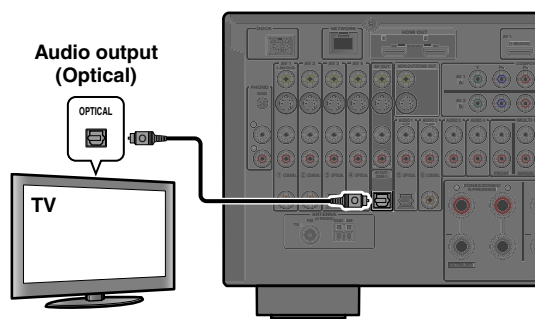
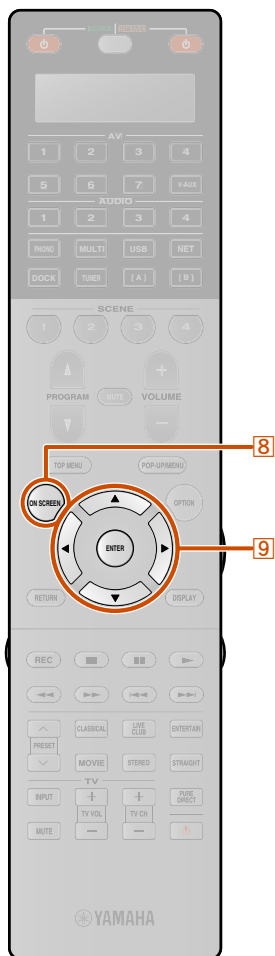

When the TV is connected with HDMI OUT 2, the default input jack is AUDIO3. If the AUDIO3 optical digital jack is connected to the TV's audio output jack, then you can enjoy TV sound through this unit right away.

To use other jacks to input audio signals from TV, carry out the following procedure.

1 Connect this unit and the TV with an HDMI cable.

2 Connect TV's audio output to this unit. The input jacks listed below are available to input TV's audio signals. Use the same jack type as used for the TV.

| TV output jack | Input jack |
|------------------------------|-----------------------------------|
| Optical digital audio output | AUDIO1 |
| Coaxial digital audio output | AUDIO2 |
| Analog stereo output | AUDIO1, AUDIO2, AUDIO3, or AUDIO4 |

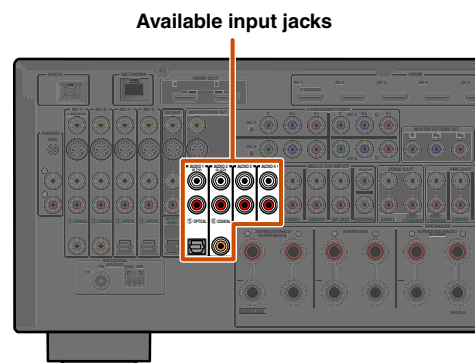

3 Press **[ON SCREEN]**. 1

4 Press **[Cursor Δ / ▽]** repeatedly to select "Setup" and press **[ENTER]**.

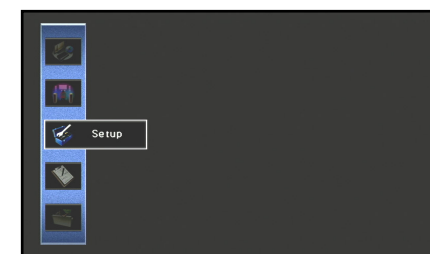

5 Press **[Cursor < / >]** repeatedly to select "HDMI" and press **[ENTER]**.



Continues to the next page

1: Refer to the "Setting various functions (Setup menu)" (esp. p. 95) for details on the Setup menu.

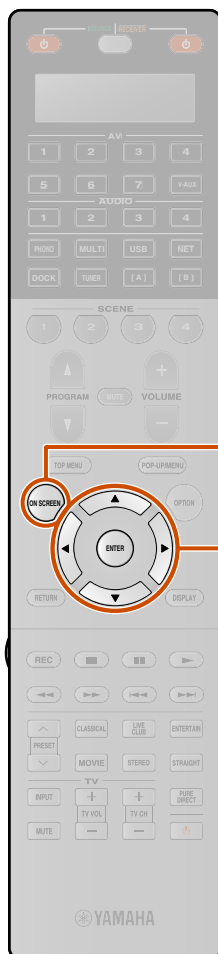

- 6** Make sure that “HDMI Control” is “On”
When “HDMI Control” is set to “Off,” press **9**ENTER and **9**Cursor Δ / ∇ to set to “On.”
- 7** Press **9**Cursor Δ / ∇ to select “Control Select” and press **9**ENTER.
- 8** Use **9**Cursor Δ / ∇ to select the HDMI OUT jack connected to the TV and press **9**ENTER.
- 9** Press **9**Cursor Δ / ∇ to select “TV Audio Input” and press **9**ENTER.
- 10** Use **9**Cursor Δ / ∇ to select the input jack connected in step 2.
- 11** Press **8**ON SCREEN when you have finished changing the settings.

If the TV hereafter transmits audio output signals, this unit will automatically switch to the input source chosen in step 10.

Single HDMI cable input to TV audio with Audio Return Channel function

When using a TV that supports HDMI functions and Audio Return Channel function, audio/video output from this unit to the TV or audio output from the TV to this unit can be transmitted through a single HDMI cable (Audio Return Channel function). Audio signals transmitted from the TV to this unit can be assigned to any input source.

- 1** Connect this unit and the TV with an HDMI cable.

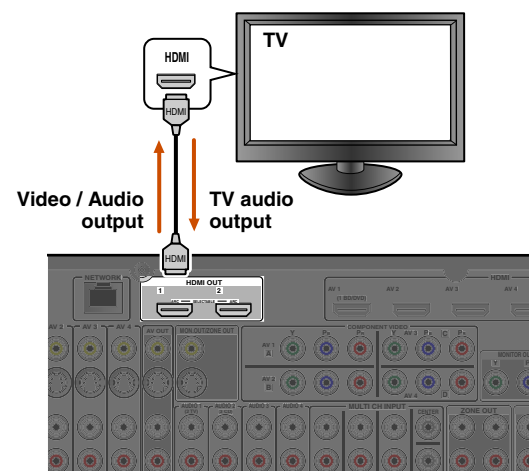

- 2** Press **8**ON SCREEN. 1
- 3** Press **9**Cursor Δ / ∇ repeatedly to select “Setup” and press **9**ENTER.

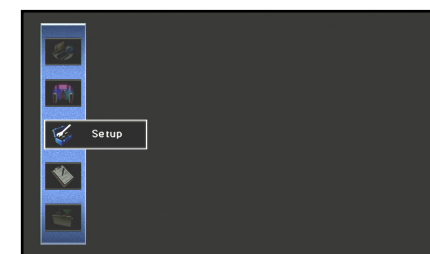



- 4** Press **9**Cursor \leftarrow / \rightarrow repeatedly to select “HDMI” and press **9**ENTER.

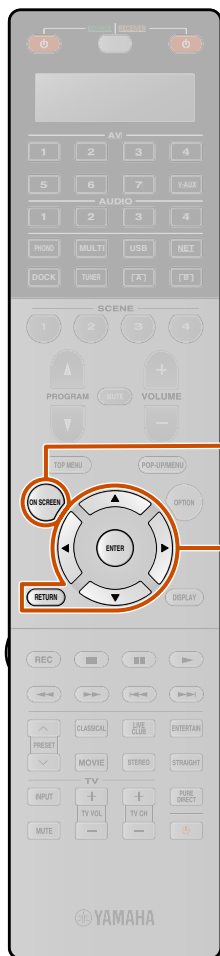

Continues to the next page

1: Refer to the “Setting various functions (Setup menu)” ([p. 95](#)) for details on the Setup menu.



- 5** Make sure that “HDMI Control” is “On.”
When “HDMI Control” is set to “Off,” press **[9]ENTER** and **[9]Cursor Δ / ▽** to set to “On.”
- 6** Press **[9]Cursor Δ / ▽** to select “Control Select” and press **[9]ENTER**.
- 7** Use **[9]Cursor Δ / ▽** to select the HDMI OUT jack connected to the TV and press **[9]ENTER**.
- 8** Press **[9]Cursor Δ / ▽** to select “TV Audio Input” and press **[9]ENTER**.
- 9** Use **[9]Cursor Δ / ▽** to select the input source to which the HDMI audio signals will be assigned, and press **[9]RETURN**.
- 10** Press **[9]Cursor Δ / ▽** to select “ARC (Audio Return Channel)” and press **[9]ENTER**. 
- 11** Press **[9]Cursor ▽** to select “On.”
The Audio Return Channel function will turn on.
- 12** Press **[8]ON SCREEN** to close the Setup menu.

If the TV hereafter transmits audio output signals, this unit will automatically switch to the input source chosen in step 9.

 **1** : While the Audio Return Channel function is on, the jack selected for the input source cannot be used.

Enjoying the contents in another room

This unit allows you to configure a multi-zone audio system. The multi-zone feature allows you to set this unit to reproduce separate input sources in the main zone and the second zone (Zone2), third zone (Zone3) and fourth zone (Zone4). You can control this unit from the second zone or third zone using the supplied remote control.

From the AV OUT/ZONE4 OUT jacks From the ZONE2 OUT/ZONE3 OUT jacks

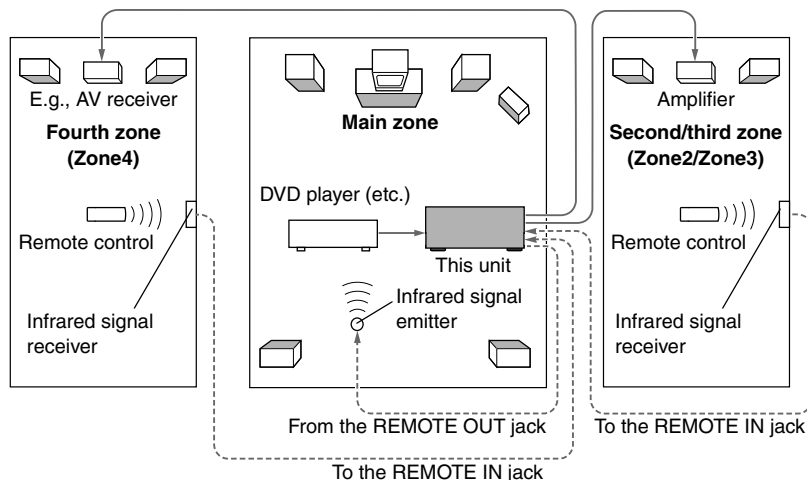

When using the external amplifier

An amplifier located in the second, third and fourth zones can be connected to this unit as shown below.

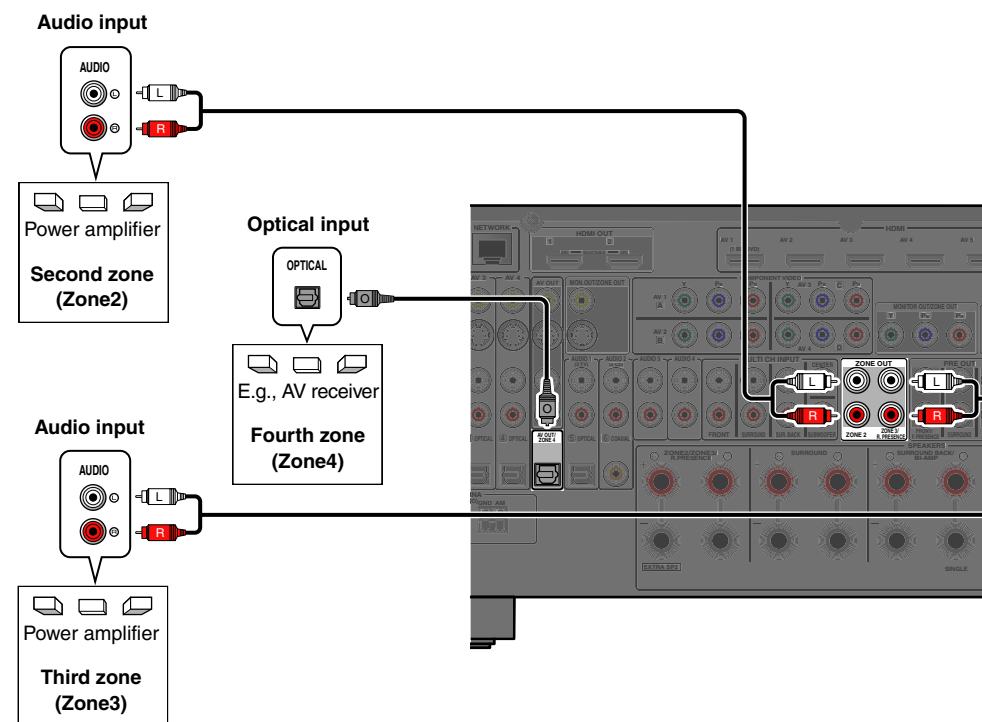

To avoid unexpected noise, DO NOT USE the multi-zone feature with CDs encoded in DTS.

When using the internal amplifier of this unit

Connect the speakers in the second zone and/or third zone to the EXTRA SP jacks directly ([p. 21](#)).

Only analog signal can be sent to Zone2 or Zone3. If you want to output sound from Zone2 or Zone3, connect an external component to AV1-4, AUDIO1-4 or V-AUX by analog connection. For example, if you want to output sound from an HDMI DVD player in Zone2, you must connect the component to this unit by both HDMI and analog connections.

Optical digital audio signal can be sent to Zone4 when "Digital Out Assign" is set to "Zone4." Refer to "Selecting the zone for optical output signal" ([p. 107](#)) for details. If you want to output sound from Zone4, connect an external component to AV1-4, AUDIO1-4 or V-AUX by digital connection.

Connecting Zone2, Zone3 or Zone4

You need the following additional equipment to use the multi-zone functions of this unit:

- An infrared signal receiver in the second zone and/or third zone.
- An infrared signal emitter in the main zone. This emitter transmits infrared signals from the remote control to a CD player or a DVD player, etc. in the main zone via the infrared signal receiver in the second zone and/or third zone.
- An amplifier and speakers in the second zone and/or third zone.
- A TV in the second zone, third zone or fourth zone.

Since there are many possible ways to connect and use this unit in a multi-zone configuration, we recommend that you consult with your nearest authorized Yamaha dealer or service center about the multi-zone connections that best meet your requirements.

Connecting zone video monitors

Connect the video monitor(s) in Zone2, Zone3 or Zone4 to MONITOR OUT/ZONE OUT jacks. If you connect the multiple zone video monitors to these jacks, the video monitors play back the selected input source for the Zone2, Zone3 or Zone4.

To assign the MONITOR OUT/ZONE OUT jacks to Zone2, Zone3 or Zone4 configure “Monitor Out Assign” ([p. 108](#)).

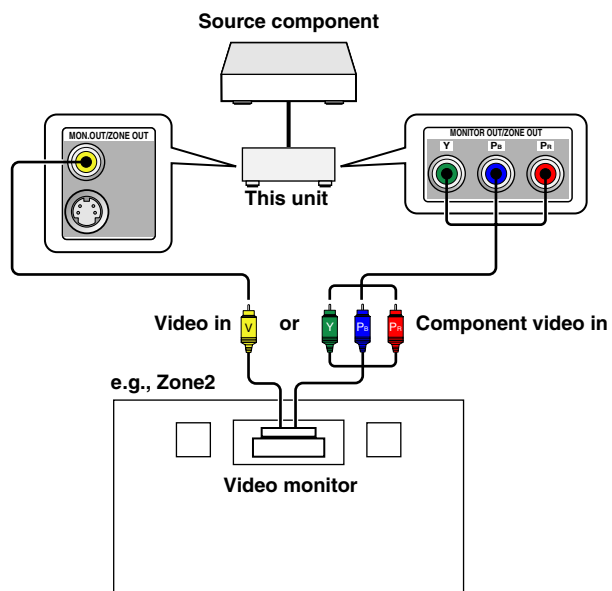

When “Monitor Out Assign” is set to “Zone2” or “Zone3,” the content window and Option menu of the input selected for the assigned zone can also be displayed on the TV monitor in the assigned zone.
(Only video signals input from the external component is output to the TV monitor in Zone4.)

Features of the Zone2/Zone3 OSD

When “Monitor Out Assign” is set to “Zone2” or “Zone3,” the Zone2 or Zone3 OSD is displayed on the TV monitor in Zone2 or Zone3.

The Zone2 or Zone3 OSD differ from the main OSD by available features. The available features for Zone2 or Zone3 OSD are as follows.

✓: available feature

| | | Features | Main OSD | Zone OSD |
|------------------|--|---------------------------|----------|----------|
| ON SCREEN menu | Input menu | Selecting Input | ✓ | — |
| | | Configuring Input | ✓ | — |
| | Sound Program menu | Selecting Sound Program | ✓ | — |
| | | Configuring Sound Program | ✓ | — |
| | Scene menu | Selecting Scene | ✓ | — |
| | | Configuring Scene | ✓ | — |
| Setup menu | | | ✓ | — |
| Information menu | | | ✓ | — |
| Content window | Now Playing view | | ✓ | ✓ |
| | Browse view | | ✓ | ✓ |
| Option menu | Tone Control, Balance, Repeat 🌟1, Shuffle 🌟1 | | ✓ | ✓ |
| | Other functions | | ✓ | — |

Controlling this unit with the remote control in other rooms

This unit is equipped with two REMOTE IN and REMOTE OUT jacks. These jacks can be used to control this unit and other components from Zone2, Zone3 or Zone4 ([p. 38](#)).

Some Yamaha models can be directly connected to the REMOTE jacks of this unit. These models may not require an infrared signal emitter. Up to 6 Yamaha components can be connected as shown below.

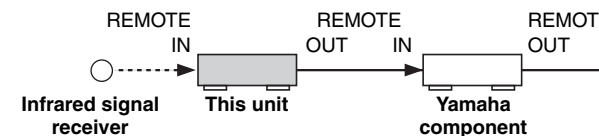

🌟 1: Only when selecting DOCK/PC/USB. Repeat and Shuffle can be displayed.



Controlling Zone2, Zone3 or Zone4

The remote control can be used to select and control Zone2, Zone3 or Zone4 devices. The available operations are as follows:

- Selecting the input source of Zone2, Zone3 or Zone4.
- Tuning into FM or AM when “TUNER” is selected as the input source of Zone2, Zone3 or Zone4.
- Adjust the volume of Zone2, Zone3 or Zone4 devices (when connected via the built-in amplifier).

Activating the Zone2, Zone3 or Zone4 operation mode

Press **29** **ZONE** to ZONE2, ZONE3 or ZONE4 before attempting to use the remote control to control Zone2, Zone3 or Zone4 devices.

Operating Zone2, Zone3 or Zone4

To enable and disable the audio output to Zone2, Zone3 or Zone4

Press **12** **RECEIVER**

To select an input source for Zone2, Zone3 or Zone4

Press **4** **Input selector**.

Only the following sources are available for the Zone2 or Zone3

AV1-4 (only analog audio input), V-AUX (only analog audio input), AUDIO1-4 (only analog audio input), PHONO, USB, NET, DOCK, TUNER

Only the following sources are available for the Zone4

AV1-4 (only COAXIAL/OPTICAL input), V-AUX (only OPTICAL input), AUDIO1-2 (only COAXIAL/OPTICAL input)

To use SCENE function for Zone2, Zone3 or Zone4

Press and hold **5** **SCENE** key for about 3 seconds to register the current setting to the scene.

Press **5** **SCENE** key to load the registered setting.

The following settings can be registered for each scene of the Zone2 or Zone3

Input, Master Volume, Tone Control

The following settings can be registered for each scene for Zone4

Input

To enable the sleep timer for Zone2, Zone3 or Zone4

Automatically switch the Zone2, Zone3 or Zone4 device to standby mode after a specified period of time has elapsed (sleep timer). Press **26** **SLEEP** repeatedly to specify a time for the sleep timer function.

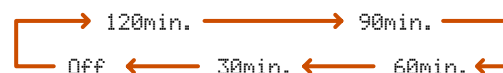

Adjusting Zone2, Zone3 or Zone4 high-/low-frequency sound (Tone Control)

1 Press **ZONE CONTROL** on the front panel.

2 Press **TONE/BALANCE** on the front panel repeatedly to select “Treble” or “Bass.”

3 Press **PROGRAM** to adjust the output level in the applicable frequency range.

| | |
|-----------------------|----------------------|
| Adjustable range | -10.0 dB to +10.0 dB |
| Adjustment increments | 2.0 dB |

The display returns to the previous display soon after the key is released.





Adjusting Zone2, Zone3 or Zone4 front speaker balance

1 Press **ZONE CONTROL** on the front panel.

2 Press **TONE/BALANCE** on the front panel repeatedly to select “Balance.”

3 Press **PROGRAM** </> to adjust balance.
The display returns to the previous display soon after the key is released.

Controlling the content window on the TV monitor in another room

When “Monitor Out Assign” is set to “Zone2” or “Zone3,” the following items can be set with Option menu in the Zone2 or Zone3.

- Adjusting the Tone Control for the Zone2 or Zone3.
- Setting the Repeat and Shuffle functions. (only when selecting DOCK/PC/USB)

NOTE

The Option menu in Zone2 or Zone3 can be controlled with the same operation as for controlling the Option menu for the main zone (p. 61).

Enjoying the music in all rooms

Use this feature to play main zone sources in other zones simultaneously. This feature is useful when you want to play back main sources as background music in a home party, etc. When using the party mode, set “Party Mode Set” to “Enable” (p. 108).

Press **23** PARTY to turn on or off the party mode.

“Party Mode On” or “Party Mode Off” appears on the front panel display or the TV screen.

While this unit is in the party mode, the PARTY indicators turn on in the front panel display.

- Input audio signals are mixed down to 2ch Stereo and output at the analog ZONE2 OUT or ZONE3 OUT jacks.
- Party mode can be turned on only when the power of main zone is turned on.
- Party mode automatically turns off when the power of main zone is turned off.



APPENDIX

Troubleshooting

Refer to the table below when this unit does not function properly.

If the problem you are experiencing is not listed below, or if the instructions below do not help, turn off this unit, disconnect the power cable, and contact the nearest authorized Yamaha dealer or service center.

General

| Problem | Cause | Remedy | See page |
|--|---|--|--------------------|
| The power will not turn on. | The protection circuitry operated 3 times consecutively. | As a safety precaution, when the protection circuitry operates 3 times consecutively, the capability to turn on the power is disabled. Contact your nearest Yamaha dealer or service center to request repair. | — |
| The unit enters standby mode soon after the power is turned on. | The power cable is not completely inserted. | Connect the power cable properly to an AC wall outlet. | — |
| | (When this unit is turned back on and “CHECK SP WIRES!” is displayed.) The protection circuitry has been activated because this unit was turned on while a speaker cable was shorted. | Make sure that all speaker cables between this unit and speakers are connected properly. | 22 |
| This unit cannot be turned off or does not work properly. | The internal microcomputer is hung-up due to an external electric shock (such as lightning or excessive static electricity) or by a drop in power supply voltage. | Disconnect the power cable from the AC wall outlet, wait about 30 seconds and then plug it in again. | — |
| | The batteries in the remote control may have lost their charge. | Replace all batteries. | 13 |
| The unit enters standby mode. | The protection circuitry has been activated because of a short circuit, etc. | Check that the speaker with an impedance of at least 6 Ω. | — |
| | | Check that the speaker impedance settings are correct. | 21 |
| | | Check that the speaker wires are not touching each other, then turn the unit back on. | — |
| | The sleep timer has turned off the unit. | Turn on the unit, and play the source again. | — |

| Problem | Cause | Remedy | See page |
|--|--|--|---------------------|
| After display of a countdown on the front panel, the unit goes into standby mode. | If you do not use take any action, the Auto Power Down function operates. | Turn on the unit, and play the source again. | — |
| | | In the Setup menu “Auto Power Down” (“Function” → “Auto Power Down”), increase the time until switching to standby mode, or turn off the Auto Power Down function. | 110 |
| No sound. | Incorrect input or output cable connections. | Connect the cables properly. If the problem persists, the cables may be defective. | 32 |
| | Speaker connections are not secure. | Secure the connections. | 22 |
| | The HDMI components connected to the unit do not support the HDCP copy protection standards. | Connect HDMI components that support the HDCP copy protection standards. | — |
| | The audio input into the device is set to playback through the TV. | In the Setup menu, set the “Amp” of “Audio Output” (“HDMI” → “Audio Output” → “Amp”) to “On.” | 105 |
| | No appropriate input source has been selected. | Select an appropriate input source with Input selector . | 51 |
| | The volume is turned down or muted. | Turn up the volume. | — |
| | Signals that this unit cannot reproduce are being input from a source component, such as a CD-ROM. | Use an input source that has signals that can be reproduced on this unit. | — |



| Problem | Cause | Remedy | See page |
|--|---|--|------------------------|
| No picture. | The video signal output from this unit is not supported by a monitor connected to this unit via the HDMI OUT 1-2 jacks. | Displays the Advanced Setup menu and select "VIDEO" in "INITIALIZE" to reset the video parameters. | 127 |
| | | Displays the Advanced Setup menu and set "MONITOR CHECK" to "YES." | 127 |
| | An appropriate video input is not selected on the TV. | Select an appropriate video input on the TV. | — |
| No sound is output from a specific speaker. | The speaker is malfunctioning. Check the Speaker indicators on the front panel display. If the corresponding indicator lights up, connect another speaker and check if sound is output. | If sound is not output, the unit may be malfunctioning. | 11 |
| | The playback component or speakers are not connected properly. | Connect the cables properly. If the problem persists, the cables may be defective. | 22, 32 |
| | Output from that speaker is disabled. | Check the Speaker indicators on the front panel display. If the corresponding indicator is turned off, try the following. 1) Change to a different input source. 2) With the selected sound program, sound is not output from that speaker. Select another sound program. 3) "None" may have been selected for that speaker on this unit. Display "Speaker" in the Setup menu, and set respective parameters to enable output from that speaker ("Speaker" → "Manual Setup" → "Configuration"). | 11, 97 |
| | The volume of that speaker is set to the minimum in "Speaker" in the Setup menu. | Display "Speaker" in the Setup menu and adjust the volume ("Speaker" → "Manual Setup" → "Level"). | 99 |
| | (If hardly any sound comes from one channel) Speaker output balance is not set correctly. | Balance the volume of each speaker from "Level" in the Setup menu ("Speaker" → "Manual Setup" → "Level"). | 99 |
| | Sound may not be output from certain channels, depending on the input source or sound program. | Try another sound program. | 54 |
| | | | |

| Problem | Cause | Remedy | See page |
|---|--|--|------------------------|
| Only the center speaker outputs substantial sound. | When a monaural source sound program is applied, for some surround decoders, sound from all channels is output from the center speaker. | Try another sound program. | 54 |
| No sound is heard from the presence speakers. | This unit is in straight decoding mode and the audio input signals have no surround channel. | Press STRAIGHT to exit straight decoding mode. | 55 |
| | Sound may not be output from certain channels depending on input sources or sound programs. | Try another sound program. | 54 |
| No sound is heard from the surround speakers. | Sound may not be output from certain channels depending on input sources or sound programs. | Try another sound program. | 54 |
| No sound is heard from the surround back speakers. | "Extended Surround" in the Option menu is set to "Off," or an input signal does not contain a surround back flag with "Extended Surround" set to "Auto." | Set "Extended Surround" other than "Off" or "Auto." | 63 |
| No sound is heard from the subwoofer. | A subwoofer is not connected, or it is inactive. | Check that a subwoofer is connected correctly, and from the Setup menu "Subwoofer1" or "Subwoofer2" ("Speaker" → "Manual Setup" → "Configuration" → "Subwoofer1" or "Subwoofer2"), set the subwoofer to "Use." | 22, 98 |
| | The subwoofer is turned off. | Turn the subwoofer power on. If the subwoofer includes an Auto Power Off function, then lower the Auto Power Off sensitivity settings. | — |
| | The source does not contain LFE (see p. 145) or low frequency signals. | | — |
| The audio input sources cannot be played in the desired digital audio signal format. | The connected component is not set to output the desired digital audio signals. | Set the playback component properly referring to its instruction manual. | — |



| Problem | Cause | Remedy | See page |
|---|--|--|---------------------|
| There is noise interference from digital or radio frequency equipment. | This unit is too close to other digital or radio frequency equipment. | Move this unit further away from such equipment. | — |
| Noise/hum noise is heard. | Incorrect cable connection. Connect the audio cables properly. | If the problem persists, the cables may be defective. | — |
| | A DTS-CD is being played back. | 1) When only noise is output If a DTS bitstream signal is not properly input to this unit, only noise is output. Connect the playback component to this unit by digital connection and playback the DTS-CD. If the condition is not improved, the problem may result from the playback component. Consult the manufacturer of the playback component. 2) When noise is output during playback or skip operation Before playing back the DTS-CD, display the Input menu after selecting the input source and set “Decoder Mode” to “DTS.” | — |
| The volume cannot be increased, or the sound is distorted. | The component connected to the output jacks of this unit is not turned on. | When the component connected to the output jacks of this unit is not turned on, the sound may be distorted, or the volume may be decreased due to the nature of AV receivers. Turn on all components connected to this unit. | — |
| | “Max Volume” is set to a low value. | Set it to a higher value. | 101 |



HDMI™

| Problem | Cause | Remedy | See page |
|--|---|--|---------------------|
| The front panel display HDMI indicator is flashing. | An error with the HDMI connection has occurred. | Try re-inserting the HDMI cable. | — |
| | | Confirm that HDMI video that is not supported by the unit is not being input (Information menu → “Video Signal”). | 113 |
| No picture or sound. | The number of components is over the limit. | Disconnect some of the HDMI components. | — |
| | The connected HDMI component does not support high-bandwidth digital copyright protection (HDCP). | Connect an HDMI component that supports HDCP. | — |
| (When using HDMI Control function) TV sound is not output from this unit when operating the remote control of the TV. | The TV audio output is not connected to this unit, or the setting to match operations carried out on TV is not set. | Connect the TV audio output to this unit, and then select the connected input source in “TV Audio Input” (Setup menu → HDMI → TV Audio Input). | 105 |
| | (When using Audio Return Channel function) The Audio Return Channel function is not working. | Make sure that your TV supports Audio Return Channel. Set the Audio Return Channel function to on (Setup menu → HDMI → ARC (Audio Return Channel)). | 104 |



Tuner (FM/AM)

FM

| Problem | Cause | Remedy | See page |
|---|--|--|--------------------|
| FM stereo reception is noisy. | You are too far from the station transmitter, or the input from the antenna is weak. | Check the antenna connections. | 41 |
| | | Switch to monaural mode. | 68 |
| | | Replace the outdoor antenna with a more sensitive multi-element antenna. | — |
| There is distortion, and clear reception cannot be obtained even with a good FM antenna. | There is multi-path interference. | Adjust the antenna height or orientation, or place it in a different location. | — |
| The desired station cannot be tuned into with the automatic tuning method. | You are in an area far from a station, or input from the antenna is weak. | Replace the outdoor antenna with a more sensitive multi element antenna. | — |
| | | Use TUN./CH   to manually select the station. | 66 |
| “No Presets” is displayed. | No preset stations are registered. | Register stations you want to listen to as preset stations before operation. | 66 |
| “Wrong Station” is displayed. | An invalid FM/AM frequency has been input. | Input a frequency that can be received. | — |

AM

| Problem | Cause | Remedy | See page |
|---|---|--|--------------------|
| The desired station cannot be tuned into with the automatic tuning method. | The signal is weak, or the antenna connections are loose. | Adjust the AM loop antenna orientation. | — |
| | | Use the manual tuning method. | 66 |
| Automatic station preset does not work. | Automatic station preset is not available for AM stations. | Use manual station preset. | 66 |
| Continuous crackling and hissing noises are heard. | The supplied AM loop antenna is not connected. | Connect the AM loop antenna correctly even if you use an outdoor antenna. | 41 |
| | The noises may be caused by lightning, fluorescent lamps, motors, thermostats, or other electrical equipment. | It is difficult to completely eliminate noise, but it can be reduced by installing and properly grounding an outdoor AM antenna. | — |
| Buzzing and whining noises are heard. | A TV set is being used nearby. | Move this unit away from the TV set. | — |



USB and Network

| Problem | Cause | Remedy | See page |
|--|---|---|---------------------|
| “No Device” is displayed even when a USB device is present. | This unit recognized the USB storage device as an illegal device. | Turn this unit off then on again. | — |
| The music files and directories in the USB device cannot be viewed. | The music files and directories are placed in locations other than the FAT area. | Place music files and directories in the FAT area. | — |
| | You are attempting to browse directory hierarchies of over 8 levels or a directory with more than 500 files. | Modify the data structure on your USB device. | — |
| The PC server/ Internet Radio does not function properly. | The IP address is not set properly. | Set the DHCP server function of the router to ON. Alternately, perform manual configuration according to the current operating environment. | 106 |
| | The network cable is not connected. | Connect it properly. | 39 |
| The music in the PC server cannot be played back. | The PC does not have Windows Media Player installed in it. | Install Windows Media Player in the PC. | — |
| | The music is recorded in a format that cannot be played on this unit. This unit cannot play music formats other than WMA, MP3, MPEG-4 AAC, FLAC, and WAV (PCM format). Also note that it cannot play certain music files even if these are recorded in the WMA, MP3, MPEG-4 AAC, FLAC, or WAV format. | Play music recorded in a format that this unit is compatible with. | — |

| Problem | Cause | Remedy | See page |
|---|--|--|----------|
| The Internet Radio cannot be played. | The firewall of the network device is activated. The Internet Radio can be played only when it passes through the port designated by each radio station. The port number is variable depending on radio station. | Check the firewall setting of the network device. | — |
| | Connection to the Internet is disconnected. | Check the configuration of the network device, and then contact the network connection provider. | — |

| Display | Cause | Remedy | See page |
|---------------|---|--|--------------------|
| Connect error | There is a problem with the signal path from your network to this unit. | Check the connection between this unit and the LAN port on your router or hub. | 39 |
| | | Make sure your router is properly connected and turned on. Also, make sure your modem is properly connected and turned on when you are attempting to listen to Internet Radio. | 39 |
| Disconnected | Your USB storage device or USB portable audio player has been disconnected from the USB port of this unit. | Check the connection between this unit and your USB storage device or USB portable audio player. | — |
| | The PC server previously connected to this unit no longer exists. | Connect this unit to the available PC server. | 39 |
| No Device | There is a problem with the signal path from your USB storage device or USB portable audio player to this unit. | Turn off this unit and reconnect your USB storage device or USB portable audio player to the USB port of this unit. | 40 |
| | | Try resetting your USB storage device or USB portable audio player. | — |



| Display | Cause | Remedy | See page |
|----------------|---|--|-------------------------|
| Access error | This unit cannot access your USB storage device or USB portable audio player. | Try another USB storage device or USB portable audio player. | — |
| | There is a problem with the signal path from your USB storage device or USB portable audio player to this unit. | Turn off this unit and reconnect your USB storage device or USB portable audio player to the USB port of this unit. Try resetting your USB storage device or USB portable audio player. | 40 — |
| Access denied | The PC you are attempting to connect has denied connection. | Configure the sharing setting of Window Media Player 11/12 and select this unit as a device to which music contents are shared. | 69 |
| Unable to play | This unit cannot play back the songs currently stored on your PC. | Make sure Windows Media Player is installed on your PC. | — |
| | | Check that the songs currently stored on your PC are playable (MP3, WMA, MPEG-4 AAC, and WAV). | — |
| | | Store some other playable music files (MP3, WMA, MPEG-4 AAC, and WAV) on your PC. | — |
| | The network may be overloaded with heavy traffic, and playback is interrupted. | Try preparing a network exclusively for use with this unit to separate it from general network traffic. | — |
| List updated | The list of the contents stored on your PC server has been updated. | | — |
| Bookmark On | The desired Internet Radio station has been added to the Bookmarks list. | | — |
| Bookmark Off | The stored Internet Radio station has been removed from the Bookmarks list. | | — |
| USB Overloaded | Over current passes through the connected USB device. | Turn off this unit and then disconnect the USB device. If the message appears when you connect the USB device again, this unit may not be compatible with the USB device. | — |

iPod™/iPhone™

| Display | Cause | Remedy | See page |
|----------------|--|--|--------------------|
| Loading... | The unit is in the process of recognizing the connection with your iPod/iPhone. | | — |
| | The unit is in the middle of acquiring song lists from your iPod/iPhone. | | — |
| Connect error | There is a problem with the signal path from your iPod/iPhone to the unit. | Turn off the unit and reconnect the Universal Dock for iPod to the DOCK jack of the unit. | 76 |
| | | Remove your iPod/iPhone from the Universal Dock for iPod and then place it back in the dock. | 76 |
| Unknown iPod | The iPod/iPhone being used is not supported by the unit. | Connect an iPod/iPhone supported by the unit. | — |
| iPod connected | Your iPod/iPhone is properly placed in the Universal Dock for iPod. | | — |
| | Your iPod/iPhone is properly placed in the Yamaha transmitter of the Yamaha Wireless System for iPod and connected with this unit via wireless transmission. | | 78 |
| Disconnected | Your iPod/iPhone is removed from the Universal Dock for iPod. | | — |
| | Your iPod/iPhone is disconnected with this unit via wireless transmission. | | — |
| Unable to play | The unit cannot playback the songs currently stored on your iPod/iPhone. | Check that songs are currently stored on your iPod/iPhone. | — |



Bluetooth™

| Display | Cause | Remedy | See page |
|--------------|---|--|--------------------|
| Searching... | The Yamaha Bluetooth Wireless Audio Receiver and the Bluetooth component are in the process of pairing. | | — |
| | The Yamaha Bluetooth Wireless Audio Receiver and the Bluetooth component are in the process of establishing a connection. | | — |
| Completed | The pairing is completed. | | — |
| Canceled | The pairing is canceled. | | — |
| BT connected | The connection between the Yamaha Bluetooth Wireless Audio Receiver and the Bluetooth component is established. | | — |
| Disconnected | The Bluetooth component is disconnected from the Yamaha Bluetooth Wireless Audio Receiver. | | — |
| Not found | The Bluetooth component is not found. | During pairing: – pairing must be performed on the Bluetooth component and this unit simultaneously. Check if the Bluetooth component is in pairing mode. | — |
| | | During connecting: – check if the Bluetooth component is turned on. – check if the Bluetooth component is within 10 m of the Yamaha Bluetooth Wireless Audio Receiver. | |
| | Pairing may not have been achieved. | Try pairing again. | 80 |

Remote control

| Problem | Cause | Remedy | See page |
|---|---|--|--|
| The remote control does not work or function properly. | Wrong distance or angle. | The remote control will function within a maximum range of 6 m, and no more than 30 degrees off-axis from the front panel. | — |
| | Direct sunlight or lighting (from an inverter type of fluorescent lamp, strobe light, etc.) is striking the remote control sensor of this unit. | Adjust the lighting angle, or reposition this unit. | — |
| | The batteries are weak. | Replace all batteries. | 13 |
| | The remote control ID of the remote control and this unit do not match. | Match the remote control ID of this unit and the remote control. | 116 , 126 |
| The battery of remote control runs out immediately. | The power of battery is not enough. | Replace the battery with alkaline battery. | — |
| External components cannot be controlled using the remote control. | The remote control code is not correctly set. | Set the remote control code correctly using “ Remote control code search ” on the CD-ROM. | — |
| | | Try setting another code for the same manufacturer using “ Remote control code search ” on the CD-ROM. | — |
| | | If this unit does not work when you press Cursor $\Delta / \nabla / \triangleleft / \triangleright$, do the following. When the key does not work during DVD disc menu operation: press the Input selector again. When there is no response with remote control operation of the Option menu/Setup menu: press SOURCE/RECEIVER (it should glow orange) and try operating the remote control again. | — |
| | Even if the remote control code is correctly set, there are some models that do not respond to the remote control. | | — |



Glossary

Audio information

Audio and video synchronization (Lipsync)

Lip sync, an abbreviation for lip synchronization, is a technical term that involves both a problem and a capability of maintaining audio and video signals synchronized during post-production and transmission. Whereas the audio and video latency requires complex end-user adjustments, HDMI version 1.3 incorporates an automatic audio and video syncing capability that allows devices to perform this synchronization automatically and accurately without user interaction.

Bi-amplification connection (Bi-amp)

A bi-amplification connection uses two amplifiers for a speaker. One amplifier is connected to the woofer section of a loudspeaker while the other is connected to the combined mid and tweeter section. With this arrangement each amplifier operates over a restricted frequency range. This restricted range presents each amplifier with a much simpler job and each amplifier is less likely to influence the sound in some way.

Dolby Digital

Dolby Digital is a digital surround sound system that gives you completely independent multi-channel audio. With 3 front channels (front L/R and center), and 2 surround stereo channels, Dolby Digital provides 5 full-range audio channels. With an additional channel especially for bass effects, called LFE (Low Frequency Effect), the system has a total of 5.1-channels (LFE is counted as 0.1 channel). By using 2-channel stereo for the surround speakers, more accurate moving sound effects and surround sound environment are possible than with Dolby Surround. The wide dynamic range from maximum to minimum volume reproduced by the 5 full-range channels and the precise sound orientation generated using digital sound processing provide listeners with unprecedented excitement and realism. With this unit, any sound environment from monaural up to a 5.1-channel configuration can be freely selected for your enjoyment.

Dolby Digital Surround EX

Dolby Digital EX creates 6 full-bandwidth output channels from 5.1-channel sources. For the best results, Dolby Digital EX should be used with movie sound tracks recorded with Dolby Digital Surround EX. With this additional channel, you can experience more dynamic and realistic moving sound especially with scenes with “fly-over” and “flyaround” effects.

Dolby Digital Plus

Dolby Digital Plus is an advanced audio technology developed for high-definition programming and media including HD broadcasts, and Blu-ray Disc. Selected as an optional audio standard for Blu-ray Disc, this technology delivers multichannel sound with discrete channel output. Supporting bitrates up to 6.0 Mbps, Dolby Digital Plus can carry up to 7.1 discrete audio channels simultaneously. Supported by HDMI version 1.3 and designed for the optical disc players and AV receivers/amplifiers of the future, Dolby Digital Plus also remains fully compatible with the existing multichannel audio systems that incorporate Dolby Digital.

Dolby Pro Logic II

Dolby Pro Logic II is an improved technique used to decode vast numbers of existing Dolby Surround sources. This new technology enables a discrete 5-channel playback with 2 front left and right channels, 1 center channel, and 2 surround left and right channels, instead of only 1 surround channel for conventional Pro Logic technology. There are three modes available: “Music mode” for music sources, “Movie mode” for movie sources, and “Game mode” for game sources.

Dolby Pro Logic IIx

Dolby Pro Logic IIx is a new technology enabling discrete multichannel playback from 2-channel or multi-channel sources. There are three modes available: “Music mode” for music sources, “Movie mode” for movie sources (for 2-channel sources only) and “Game mode” for game sources.

Dolby TrueHD

Dolby TrueHD is an advanced lossless audio technology developed for high-definition disc-based media including Blu-ray Disc. Selected as an optional audio standard for Blu-ray Disc, this technology delivers sound that is bit-for-bit identical to the studio master, offering a high-definition home theater experience. Supporting bitrates up to 18.0 Mbps, Dolby TrueHD can carry up to 8 discrete channels of 24-bit/96 kHz audio simultaneously. Dolby TrueHD also remains fully compatible with the existing multichannel audio systems and retains the metadata capability of Dolby Digital, allowing dialog normalization and dynamic range control.

DTS 96/24

DTS 96/24 offers an unprecedented level of audio quality for multichannel sound on DVD video, and is fully backward-compatible with all DTS decoders. “96” refers to a 96 kHz sampling rate compared to the typical 48 kHz sampling rate. “24” refers to 24-bit word length. DTS 96/24 offers sound quality transparent to the original 96/24 master, and 96/24 5.1-channel sound with full-quality full-motion video for music programs and motion picture soundtracks on DVD video.

DTS Digital Surround

DTS digital surround was developed to replace the analog soundtracks of movies with a 5.1-channel digital sound track, and is now rapidly gaining popularity in movie theaters around the world. DTS, Inc. has developed a home theater system so that you can enjoy the depth of sound and natural spatial representation of DTS digital surround in your home. This system produces practically distortion-free 6-channel sound (technically, front left and right, center, surround left and right, and LFE 0.1 (subwoofer) channels for a total of 5.1 channels). This unit incorporates a DTS-ES decoder that enables 6.1-channel reproduction by adding the surround back channel to the existing 5.1-channel format.

DTS Express

This is an audio format for next-generation optical discs such as Blu-ray discs. It uses optimized low bit rate signals for network streaming. In the case of a Blu-ray disc, this format is used with secondary audio, enabling you to enjoy the commentary of the movie producer via the Internet while playing the main program.

DTS-HD High Resolution Audio

DTS-HD High Resolution Audio is a high resolution audio technology developed for high-definition disc-based media including Blu-ray Disc. Selected as an optional audio standard for Blu-ray Disc, this technology delivers sound that is virtually indistinguishable from the original, offering a high-definition home theater experience.

Supporting bitrates up to 6.0 Mbps for Blu-ray Disc, DTS-HD High Resolution Audio can carry up to 7.1 discrete channels of 24-bit/96 kHz audio simultaneously.

DTS-HD High Resolution Audio also remains fully compatible with the existing multichannel audio systems that incorporate DTS Digital Surround.



DTS-HD Master Audio

DTS-HD Master Audio is an advanced lossless audio technology developed for high-definition disc-based media including Blu-ray Disc. Selected as an optional audio standard for Blu-ray Disc, this technology delivers sound that is bit-for-bit identical to the studio master, offering a high-definition home theater experience.

Supporting bitrates up to 24.5 Mbps for Blu-ray Disc, DTS-HD Master Audio can carry up to 7.1 discrete channels of 24-bit/96 kHz audio simultaneously. Supported by HDMI version 1.3 and designed for the optical disc players and AV receivers/amplifiers of the future, DTS-HD Master Audio also remains fully compatible with the existing multichannel audio systems that incorporate DTS Digital Surround.

DTS Neo:6

Neo:6 decodes the conventional 2-channel sources for 6-channel playback by the specific decoder. It enables playback with the fullrange channels with higher separation just like digital discrete signal playback. There are two modes available: "Music mode" for music sources and "Cinema mode" for movie sources.

DSD

Direct Stream Digital (DSD) technology stores audio signals on digital storage media, such as Super Audio CDs. Using DSD, signals are stored as single bit values at a high-frequency sampling rate of 2.8224 MHz, while noise shaping and oversampling are used to reduce distortion, a common occurrence with very high quantization of audio signals. Due to the high sampling rate, better audio quality can be achieved than that offered by the PCM format used for normal audio CDs. The frequency is equal to or higher than 100 kHz and the dynamic range is 120 dB. This unit can transmit or receive DSD signals input from the HDMI jack.

FLAC

This is a file format for lossless audio data compression. FLAC is inferior to lossy compression formats in compression rate but provides higher audio quality.

MP3

One of the audio compression methods used by MPEG. It employs the irreversible compression method, which achieves a high compression rate by thinning out the data of hardly audible part to the human ears. It is said to be capable of compressing the data quantity by about 1/11 (128 kbps) while maintaining a similar audio quality to music CD.

MPEG-4 AAC

An MPEG-4 audio standard. As it allows compression of data at a bit rate lower than that of MPEG-2 AAC, it is used among others for mobile telephones, portable audio players and other low-capacity devices requiring high sound quality. In addition to the above types of devices, MPEG-4 AAC is also used to distribute contents on the Internet, and as such is supported by computers, media servers and many other devices.

LFE 0.1 channel

This channel reproduces low-frequency bass signals, and has a frequency range from 20 Hz to 120 Hz. This channel is counted as 0.1, because it only enforces a low-frequency range compared to the full-range reproduced by the other 5-channels in Dolby Digital or DTS 5.1-channel systems.

PCM (Linear PCM)

Linear PCM is a signal format under which an analog audio signal is digitized, recorded and transmitted without using any compression. This is used as a method of recording CDs and DVD audio. The PCM system uses a technique for sampling the size of the analog signal per very small unit of time. Standing for "Pulse Code Modulation," the analog signal is encoded as pulses and then modulated for recording.

Sampling frequency and number of quantized bits

When digitizing an analog audio signal, the number of times the signal is sampled per second is called the sampling frequency, while the degree of fineness when converting the sound level into a numeric value is called the number of quantized bits. The range of rates that can be played back is determined based on the sampling rate, while the dynamic range representing the sound level difference is determined by the number of quantized bits. In principle, the higher the sampling frequency, the wider the range of frequencies that can be played back, and the higher the number of quantized bits, the more finely the sound level can be reproduced.

WAV

Windows standard audio file format, which defines the method of recording the digital data obtained by converting audio signals. It does not specify the compression (coding) method so a desired compression method can be used with it. By default, it is compatible with the PCM method (no compression) and some compression methods including the ADPCM method.

WMA

An audio compression method developed by Microsoft Corporation. It employs the irreversible compression method, which achieves a high compression rate by thinning out the data of hardly audible part to the human ears. It is said to be capable of compressing the data quantity by about 1/22 (64 kbps) while maintaining a similar audio quality to music CD.

Sound program information**CINEMA DSP**

Since the Dolby Surround and DTS systems were originally designed for use in movie theaters, their effect is best felt in a theater having many speakers designed for acoustic effects. Since home conditions, such as room size, wall material, number of speakers, and so on, can differ so widely, it is inevitable that there are differences in the sound that is heard. Based on a wealth of actually measured data, Yamaha CINEMA DSP uses Yamaha's original DSP technology to combine Dolby Pro Logic, Dolby Digital, and DTS systems to provide the audiovisual experience of a movie theater in the listening room of your own home.

CINEMA DSP 3D

The actually measured sound field data contain the information of the height of the sound images. CINEMA DSP 3D feature achieves the reproduction of the accurate height of the sound images so that it creates the accurate and intensive stereoscopic sound fields in a listening room.

Compressed music enhancer

The Compressed music enhancer feature of this unit enhances your listening experience by regenerating the missing harmonics in compression artifacts. As a result, it compensates for flattened complexity due to the loss of high-frequency fidelity as well as lack of bass due to the loss of low-frequency bass, providing improved performance for the overall sound system.

SILENT CINEMA

Yamaha has developed a natural, realistic sound effect DSP algorithm for headphones. Parameters for headphones have been set for each sound program, so that accurate representations of all the sound programs can be enjoyed on headphones.

Virtual CINEMA DSP

Yamaha has developed a Virtual CINEMA DSP algorithm that allows you to enjoy DSP surround effects even without any surround speakers, by using virtual surround speakers. It is even possible to enjoy Virtual CINEMA DSP using a minimal two-speaker system that does not include a center speaker.



Video information

Component video signal

With the component video signal system, the video signal is separated into the Y signal for luminance and the Pb and Pr signals for chrominance. Color can be reproduced more faithfully with this system because each of these signals is independent. The component signal is also called the “color difference signal” because the luminance signal is subtracted from the color signal. A monitor with component input jacks is required in order to output component signals.

Composite video signal

With the composite video signal system, the video signal comprises the three basic elements of a video picture: color, brightness and synchronization data. A composite video jack on a video component transmits these three elements combined.

Deep Color

Deep Color refers to the use of various color depths in displays, up from the 24-bit depths in previous versions of the HDMI specification. This extra bit depth allows HDTVs and other displays go from millions of colors to billions of colors and eliminate on-screen color banding for smooth tonal transitions and subtle gradations between colors. The increased contrast ratio can represent many times more shades of gray between black and white. Also, Deep Color increases the number of available colors within the boundaries defined by the RGB or YCbCr color space.

HDMI

HDMI (High-Definition Multimedia Interface) is the first industry supported, uncompressed, all-digital audio/video interface. Providing an interface between any sources (such as set-top boxes or AV receivers) and audio/video monitor (such as digital television), HDMI supports standard, enhanced or high-definition video as well as multichannel digital audio using a single cable. HDMI transmits all ATSC HDTV standards and supports 8-channel digital audio, with bandwidth to spare to accommodate future enhancements and requirements.

When used in combination with HDCP (High-bandwidth Digital Content Protection), HDMI provides a secure audio/video interface that meets the security requirements of content providers and system operators. For further information on HDMI, visit the HDMI website at “<http://www.hdmi.org/>.”

S-video signal

With the S-video signal system, the video signal normally transmitted using a pin cable is separated and transmitted as the Y signal for the luminance and the C signal for the chrominance through the S-video cable. Using the S-VIDEO jack eliminates video signal transmission loss and allows recording and playback of even more beautiful images.

“x.v.Color”

A color space standard supported by HDMI version 1.3. It is a more extensive color space than sRGB, and allows the expression of colors that could not be expressed before. While remaining compatible with the color gamut of sRGB standards, “x.v.Color” expands the color space, and can thus produce more vivid, natural images. It is particularly effective for still pictures and computer graphics.

Compatibility of the input and output video signals

Analog-to-HDMI video conversion is performed according to resolution of video signals as shown below. Analog-to-analog video conversion is also possible when “Analog to Analog Conversion” is set to “On” (p. 102).

✓: available conversion

| | Resolution | HDMI output | | | | | COMPONENT VIDEO output | | | | S-VIDEO output | VIDEO output |
|-----------------------|------------|-------------|-----------|------|-------|-------|------------------------|-----------|------|-------|----------------|--------------|
| | | 480i/576i | 480p/576p | 720p | 1080i | 1080p | 480i/576i | 480p/576p | 720p | 1080i | 480i/576i | 480i/576i |
| HDMI input | 480i/576i | ✓ | ✓ | ✓ | ✓ | ✓ | | | | | | |
| | 480p/576p | | ✓ | ✓ | ✓ | ✓ | | | | | | |
| | 720p | | ✓ | ✓ | ✓ | ✓ | | | | | | |
| | 1080i | | ✓ | ✓ | ✓ | ✓ | | | | | | |
| | 1080p | | ✓ | ✓ | ✓ | ✓ | | | | | | |
| COMPONENT VIDEO input | 480i/576i | ✓ | ✓ | ✓ | ✓ | ✓ | ✓ | | | | ✓ | ✓ |
| | 480p/576p | | ✓ | ✓ | ✓ | ✓ | | ✓ | | | | |
| | 720p | | ✓ | ✓ | ✓ | ✓ | | | ✓ | | | |
| | 1080i | | ✓ | ✓ | ✓ | ✓ | | | | ✓ | | |
| S-VIDEO input | 480i/576i | ✓ | ✓ | ✓ | ✓ | ✓ | | | | ✓ | ✓ | |
| VIDEO input | 480i/576i | ✓ | ✓ | ✓ | ✓ | ✓ | | | | ✓ | ✓ | |



Information on HDMI™

■ HDMI signal compatibility

Audio signals

| Audio signal types | Audio signal formats | Compatible media |
|-----------------------------------|--|---------------------------------------|
| 2ch Linear PCM | 2ch, 32-192 kHz, 16/20/24 bit | CD, DVD-Video, DVD-Audio, etc. |
| Multi-ch Linear PCM | 8ch, 32-192 kHz, 16/20/24 bit | DVD-Audio, Blu-ray Disc, HD DVD, etc. |
| DSD | 2/5.1ch, 2.8224 MHz, 1 bit | SACD, etc. |
| Bitstream | Dolby Digital, DTS | DVD-Video, etc. |
| Bitstream (High definition audio) | Dolby TrueHD, Dolby Digital Plus, DTS-HD Master Audio, DTS-HD High Resolution Audio, DTS Express | Blu-ray Disc, HD DVD, etc. |

- If the input source component can decode the bitstream audio signals of audio commentaries, you can playback the audio sources with the audio commentaries mixed down by using the digital audio input (optical or coaxial) connections.
- Refer to the supplied instruction manuals of the input source component, and set the component appropriately.

NOTES

- When CPPM copy-protected DVD-Audio is played back, video and audio signals may not be output, depending on the type of the DVD player.
- This unit is not compatible with HDCP-incompatible HDMI or DVI components.
- Refer to the supplied instruction manuals for details.
To decode audio bitstream signals on this unit, set the input source component appropriately so that the component outputs the bitstream audio signals directly (does not decode the bitstream signals on the component).
- This unit is not compatible with the audio commentary features (for example, the special audio contents downloaded via Internet) of Blu-ray Disc or HD DVD. This unit does not playback the audio commentaries of the Blu-ray Disc or HD DVD content.

Video signals

This unit is compatible with the video signals of the following resolutions:

- 480i/60 Hz
- 576i/50 Hz
- 480p/60 Hz
- 576p/50 Hz
- 720p/60 Hz, 50 Hz
- 1080i/60 Hz, 50 Hz
- 1080p/60 Hz, 50 Hz, 24 Hz



About trademarks



Manufactured under license from Dolby Laboratories. Dolby, Pro Logic and the double-D symbol are trademarks of Dolby Laboratories.



Manufactured under license under U.S. Patent #'s: 5,451,942; 5,956,674; 5,974,380; 5,978,762; 6,226,616; 6,487,535; 7,212,872; 7,333,929; 7,392,195; 7,272,567 & other U.S. and worldwide patents issued & pending. DTS and the Symbol are registered trademarks, & DTS-HD, DTS-HD Master Audio, and the DTS logos are trademarks of DTS, Inc. Product includes software. © DTS, Inc. All Rights Reserved.

iPod™, iPhone™

“iPod” is a trademark of Apple Inc., registered in the U.S. and other countries. “iPhone” is a trademark of Apple Inc.



Fraunhofer Institut
Integrierte Schaltungen

MPEG Layer-3 audio coding technology licensed from Fraunhofer IIS and Thomson.



This receiver supports network connections.

Bluetooth™

Bluetooth is a registered trademark of the Bluetooth SIG and is used by Yamaha in accordance with a license agreement.



“HDMI,” the “HDMI” logo and “High-Definition Multimedia Interface” are trademarks, or registered trademarks of HDMI Licensing LLC.

x.v.Color™

“x.v.Color” is a trademark of Sony Corporation.



“SILENT CINEMA” is a trademark of Yamaha Corporation.

Windows XP, Windows Vista, Windows 7, Windows Media Audio, Windows Media Connect and Windows Media Player are either registered trademarks or trademarks of Microsoft Corporation in the United States and/or other countries.



Specifications

| | | | |
|--|---|--|---------------------------------|
| ■ Input | | | |
| • Analog Audio | | | |
| RCA | 10 | | |
| AV1-4, AUDIO1-4, PHONO, VIDEO AUX | | | |
| MULTI CH INPUT | 8ch | | |
| FRONT L/R, CENTER, SURROUND L/R, SURROUND BACK L/R, SUBWOOFER | | | |
| • Digital Audio | | | |
| Optical | 4 (AV3-4, AUDIO1, VIDEO AUX) | | |
| Coaxial | 3 (AV1-2, AUDIO2) | | |
| • Analog Video | | | |
| Composite | 5 (AV1-4, VIDEO AUX) | | |
| S-video | 5 (AV1-4, VIDEO AUX) | | |
| Component | 4 (AV1-4) | | |
| • Other | | | |
| DOCK | 1 (Audio L/R, Composite Video, S-video) | | |
| ■ Output | | | |
| • Analog Audio | | | |
| SPEAKERS | 11ch (7ch + Extra 4ch) | | |
| FRONT L/R, CENTER, SURROUND L/R, SURROUND BACK/BI-AMP L/R, EXTRA SP1 (ZONE2/ZONE3/F.PRESENCE L/R), EXTRA SP2 (ZONE2/ZONE3/R.PRESENCE L/R) | | | |
| PRE OUT | 9ch | | |
| FRONT/F.PRESENCE L/R, CENTER, SURROUND L/R, SURROUND BACK L/R, R.PRESENCE L/R* | | | |
| *: Barter to Zone3 | | | |
| SUBWOOFER (Stereo, Front & Rear 2ch) | | | |
| AV OUT | 1 | | |
| ZONE2 OUT | 1 | | |
| ZONE3/R.PRESENCE OUT | 1 | | |
| • Digital Audio | | | |
| Optical | 1 (AV OUT/ZONE4 OUT) | | |
| • Analog Video | | | |
| MONITOR OUT/ZONE OUT | | | |
| Composite | 1 | | |
| S-video | 1 | | |
| Component | 1 | | |
| | | AV OUT | |
| | | Composite | 1 |
| | | S-video | 1 |
| ■ HDMI | | | |
| • Input | 8 (AV1-7, VIDEO AUX) | | |
| • Output | 2 (HDMI OUT) | | |
| • HDMI Specification | | | |
| Deep Color 30/36 bit, "x.v.Color," Auto Lips Sync, HD Audio, ARC (Audio Return Channel), 3D | | | |
| • Audio Format | | | |
| Dolby Digital, DTS, DSD 6ch, Dolby Digital Plus, Dolby TrueHD, DTS-HD, PCM 2ch-8ch | | | |
| • Content Protection | HDCP compatible | | |
| ■ Tuner | | | |
| • Analog Tuner | | | |
| FM/AM | 1 (TUNER) | | |
| • [U.S.A. model] HD Radio with iTunes Tagging | 1 (TUNER) | | |
| • [U.S.A. model] Satellite Radio Ready | | | |
| SIRIUS Radio | 1 (SIRIUS) | | |
| ■ Network | | | |
| • USB (USB1.1 Full Speed) | 1 | | |
| Device Type | USB Mass Storage Class, MTP | | |
| Audio Format | MP3, WMA, WAV, MPEG-4 AAC, FLAC | | |
| Max Audio Support fs | 48 kHz/24 bit | | |
| Cover Art Format | PNG, JPEG | | |
| • Ethernet (100Base-TX/10Base-TX) | 1 | | |
| Internet Radio | | | |
| Audio Format | MP3, WMA | | |
| PC Server | | | |
| Audio Format | MP3, WMA, WAV, MPEG-4 AAC, FLAC | | |
| Max Audio Support fs | 96 kHz/24 bit | | |
| Cover Art Format | PNG, JPEG | | |
| | | DLNA | |
| | | Version | 1.5 (DMP & DMR support) |
| | | Audio Format | MP3, WMA, WAV, MPEG-4 AAC, FLAC |
| | | Max Audio Support fs | 96 kHz/24 bit |
| | | Cover Art Format | PNG, JPEG |
| | | [U.S.A. model] Internet Music Service | |
| | | Rhapsody, Sirius Internet Radio | |
| | | Network Control | |
| | | Web Browse Control, MusicCAST2 Commander Support, Yamaha Network Control Support (YNC), Receiver Manager Support | |
| ■ Remote | | | |
| • RS-232C | 1 | | |
| • REMOTE IN | 2 | | |
| • REMOTE OUT | 2 | | |
| • TRIGGER OUT | 2 (12 V/total 100 mA max.) | | |
| ■ Compatible Decoding Format | | | |
| • Decoding Format | | | |
| Dolby TrueHD, Dolby Digital Plus, Dolby Digital, Dolby Digital EX, DTS-HD Master Audio, DTS-HD High Resolution Audio, DTS Express, DTS, DTS-ES Matrix 6.1, DTS-ES Discrete 6.1, DTS 96/24 | | | |
| • Post Decoding Format | | | |
| Dolby Pro Logic, Dolby Pro Logic II Music, Dolby Pro Logic II Movie, Dolby Pro Logic II Game, Dolby Pro Logic IIx Music, Dolby Pro Logic IIx Movie, Dolby Pro Logic IIx Game, DTS Neo:6 Music, DTS Neo:6 Cinema | | | |
| ■ Audio Section | | | |
| • Minimum RMS Output Power (20 Hz to 20 kHz, 0.06 % THD, 8 Ω) | | | |
| FRONT L/R | 140 W + 140 W | | |
| CENTER | 140 W | | |
| SURROUND L/R | 140 W + 140 W | | |
| SURROUND BACK L/R | 140 W | | |
| • Dynamic Power (IHF) | | | |
| FRONT L/R, 8/6/4/2 Ω | 175/220/295/415 W | | |



- Dynamic Headroom
 - 8 Ω 1.0 dB
- Damping Factor
 - FRONT L/R, 1 kHz, 8 Ω 150 or more
- Input Sensitivity/Input Impedance
 - PHONO 3.5 mV/47 kΩ
 - AUDIO2 etc. 200 mV/47 kΩ
 - MULTI CH IN 200 mV/47 kΩ
- Maximum Input Level
 - PHONO (1 kHz, 0.1 % THD) 60 mV or more
 - AUDIO2 etc. (1 kHz, 0.5 % THD) 2.4 V or more
- Output Level/Output Impedance
 - AV OUT 200 mV/1.2 kΩ
 - HEADPHONE OUT 150 mV/100 Ω
 - PRE OUT 1.0 V/1.2 kΩ
 - ZONE2 OUT 1.0 V/1.2 kΩ
 - ZONE3/R.PRESENCE OUT 1.0 V/1.2 kΩ
- Frequency Response
 - AUDIO2 etc. to FRONT L/R
(Pure Direct, 10 Hz to 100 kHz) +0/-3 dB
- Total Harmonic Distortion
 - PHONO to AV OUT (20 Hz to 20 kHz, 1 V) 0.02 % or less
 - AV1 to FRONT L/R (20 Hz to 20 kHz, 70 W/8 Ω) ... 0.04 % or less
- Signal to Noise Ratio (IHF-A Network)
 - PHONO (input shorted, 5 mV) to AV OUT
[U.S.A and Canada models] 86 dB or more
 - [Australia models] 81 dB or more
 - AUDIO2 etc. (input shorted, 250 mV) to FRONT L/R
..... 100 dB or more
- Residual Noise (IHF-A Network)
 - FRONT L/R 150 μV or less
- Channel Separation (1 kHz/10 kHz)
 - PHONO (input shorted) 60 dB/55 dB or more
 - AV1 etc. (input 5.1 kΩ shorted) 60 dB/45 dB or more
- Volume Control
 - Main Zone MUTE/-80 to +16.5 dB
 - Zone2, Zone3 MUTE/-80 to +16.5 dB

- Tone Control Characteristics
 - Main Zone (FRONT, CENTER, SUBWOOFER)
 - Bass Boost/Cut ±6 dB/50 Hz
 - Bass Turnover Frequency 350 Hz
 - Treble Boost/Cut ±6 dB/20 kHz
 - Treble Turnover Frequency 3.5 kHz
 - Zone2, Zone3
 - Bass Boost/Cut ±10 dB/100 Hz
 - Bass Turnover Frequency 350 Hz
 - Treble Boost/Cut ±10 dB/10 kHz
 - Treble Turnover Frequency 3.5 kHz
- Filter Characteristics (fc=40/60/80/90/100/110/120/160/200 Hz)
 - H.P.F. (FRONT, CENTER, SURROUND, SURROUND BACK:
Small) 12 dB/oct.
 - L.P.F. (SUBWOOFER) 24 dB/oct.

■ Video Section

- Video Format (MONITOR OUT/ZONE OUT, Wall Paper/OSD)
 - [U.S.A. and Canada models] NTSC/PAL
 - [Australia model] PAL/NTSC
- Video Signal Type (Video Conversion) NTSC/PAL
- Signal Level
 - Composite 1 Vp-p/75 Ω
 - S-video
 - NTSC 1 Vp-p/75 Ω (Y), 0.286 Vp-p/75 Ω (C)
 - PAL 1 Vp-p/75 Ω (Y), 0.3 Vp-p/75 Ω (C)
 - Component 1 Vp-p/75 Ω (Y), 0.7 Vp-p/75 Ω (PB/PR)
- Maximum Input Level (Video Conversion Off) 1.5 Vp-p or more
- Signal to Noise Ratio (Video Conversion Off) 60 dB or more
- Frequency Response (Video Conversion Off)
 - Component (MONITOR OUT/ZONE OUT)
..... 5 Hz to 100 MHz, ±3 dB

■ FM Section

- Tuning Range
 - [U.S.A. and Canada models] 87.5 to 107.9 MHz
 - [Australia model] 87.50 to 108.00 MHz
- 50 dB Quieting Sensitivity (IHF)
 - Mono 3.0 μV (20.8 dBf)
- Signal to Noise Ration (IHF)
 - Mono/Stereo 74 dB/70 dB
 - [U.S.A. model] HD 80 dB
- Harmonic Distortion (1 kHz)
 - Mono/Stereo 0.3 %/0.3 %
 - [U.S.A. model] HD 0.03 %
- Antenna Input 75 Ω (unbalanced)

■ AM Section

- Tuning Range
 - [U.S.A. and Canada models] 530 to 1710 kHz
 - [Australia model] 531 to 1611 kHz

■ General

- Power Supply
 - [U.S.A. and Canada models] AC 120 V, 60 Hz
 - [Australia model] AC 240 V, 50 Hz
- Power Consumption
 - [U.S.A. model] 490 W/620 VA
 - [Canada model] 400 W/510 VA
 - [Australia model] 490 W
- Standby Power Consumption
 - HDMI Control Off/Standby Through Off 0.3 W or less
 - HDMI Control On/Standby Through On 2.7 W (typical)
 - NET Standby On 4.5 W (typical)
- Dimensions (W x H x D)
 - 435 x 182 x 430 mm (17-1/8 x 7-1/8 x 16-7/8 in)
- Weight 17.0 kg (37.5 lbs.)



Index

Numerics

| | |
|-------------------------------------|----|
| 2ch stereo playback..... | 56 |
| 5 channel speaker layout..... | 18 |
| 5.1-channel speaker layout..... | 17 |
| 7.1-channel speaker connection..... | 20 |
| 7.1-channel speaker layout..... | 16 |

A

| | |
|---|-----|
| Adaptive DRC, Option menu..... | 63 |
| Adaptive DSP Level, Sound setup..... | 102 |
| Advanced Setup menu..... | 125 |
| Advanced speaker configuration..... | 23 |
| AM antenna connection..... | 41 |
| AM tuning..... | 66 |
| Analog to Analog Conversion, Video setup..... | 102 |
| ARC (Audio Return Channel), HDMI setup..... | 104 |
| Aspect, Processing, Video setup..... | 103 |
| AUDIO jack..... | 28 |
| Audio Output, HDMI setup..... | 105 |
| Audio Return Channel function..... | 131 |
| Audio Select, Option menu..... | 64 |
| Audio Signal, Information menu..... | 113 |
| Auto Power Down, Function setup..... | 110 |
| Auto Preset..... | 68 |
| Auto Setup, Speaker setup..... | 96 |

B

| | |
|------------------------------------|----|
| Basic playback..... | 51 |
| BD player connection..... | 32 |
| Bi-amp connection, speaker..... | 21 |
| Bluetooth™ component playback..... | 80 |
| Bookmark Off, Internet Radio..... | 73 |
| Bookmark On, Internet Radio..... | 73 |
| Browse view..... | 65 |

C

| | |
|---------------------------------------|----|
| Cable plug..... | 28 |
| Center Image, Sound Program menu..... | 94 |

| | |
|---|-----|
| Center Level, Sound Program menu..... | 93 |
| Center speaker..... | 15 |
| Center Width, Sound Program menu..... | 94 |
| Changing speaker impedance..... | 21 |
| CINEMA DSP 3D mode..... | 55 |
| CINEMA DSP 3D Mode, Option menu..... | 63 |
| CINEMA DSP indicator..... | 11 |
| CINEMA DSP parameters..... | 91 |
| CLEAR..... | 122 |
| Clear All Preset..... | 68 |
| Clear Preset..... | 68 |
| Close, DOCK (iPod)..... | 77 |
| COAXIAL jack..... | 28 |
| COMPONENT VIDEO jack..... | 28 |
| Compressed Music Enhancer..... | 56 |
| Configuration, Manual Setup, Speaker setup..... | 97 |
| Connect, Option menu..... | 64 |
| Connecting speakers..... | 20 |
| Connecting to network..... | 39 |
| Connecting USB storage device..... | 40 |
| Connections..... | 15 |
| Content window..... | 65 |
| Control Select, HDMI setup..... | 104 |
| Controlling Zone2, Zone3 or Zone4..... | 135 |
| Cursor indicators..... | 11 |

D

| | |
|---|--------|
| Decode Type, Sound Program menu..... | 93, 94 |
| Decoder Mode, Input menu..... | 86 |
| Dialogue Lift, Option menu..... | 63 |
| Digital Out Assign, Multi Zone setup..... | 107 |
| Dimension, Sound Program menu..... | 94 |
| Direct, Sound Program menu..... | 93 |
| Disconnect, Option menu..... | 64 |
| Display Set, Function setup..... | 111 |
| Distance, Speaker setup..... | 99 |
| DMC Control, Input menu..... | 86 |
| DSP Level, Sound Program menu..... | 91 |
| DVD player connection..... | 32 |

| | |
|---------------------------------|-----|
| Dynamic Range, Sound setup..... | 101 |
|---------------------------------|-----|

E

| | |
|-------------------------------------|-----|
| Enhancer, Input menu..... | 86 |
| ERASE..... | 123 |
| Extended Surround, Option menu..... | 63 |
| External component connection..... | 28 |
| External decoder connection..... | 37 |

F

| | |
|---|-----|
| Features of Web Control Center..... | 82 |
| Features of Zone OSD..... | 134 |
| FIRM UPDATE, Advanced Setup menu..... | 128 |
| FM antenna connection..... | 41 |
| FM Mode..... | 68 |
| FM tuning..... | 66 |
| Front panel..... | 8 |
| Front panel display..... | 11 |
| Front Presence L Level, Sound Program menu..... | 93 |
| Front Presence R Level, Sound Program menu..... | 94 |
| Front speaker..... | 15 |
| Function setup..... | 109 |

G

| | |
|----------------------|----|
| Game connection..... | 37 |
|----------------------|----|

H

| | |
|--------------------------------------|-----|
| HDMI Control function..... | 129 |
| HDMI Control, HDMI setup..... | 104 |
| HDMI indicator..... | 11 |
| HDMI jack..... | 28 |
| HDMI Monitor, Information menu..... | 113 |
| HDMI setup..... | 104 |
| High-frequency sound adjustment..... | 52 |

I

| | |
|-----------------------|-----|
| Information menu..... | 113 |
|-----------------------|-----|



| | |
|---|-----|
| Initial Delay, Sound Program menu..... | 91 |
| Initial Volume, Sound setup | 101 |
| INITIALIZE, Advanced Setup menu | 127 |
| Input Assignment, Function setup | 110 |
| Input menu | 84 |
| Input menu list | 85 |
| Internet Radio..... | 73 |
| IP Address, Network setup | 106 |
| iPhone™ playback | 76 |
| iPod Interlock, Input menu | 86 |
| iPod™ playback..... | 76 |
| J | |
| Jack | 28 |
| L | |
| Language..... | 112 |
| LEARN | 118 |
| Level, Speaker setup | 99 |
| Lipsync, Sound setup | 101 |
| Liveness, Sound Program menu | 92 |
| Load, Scene menu | 88 |
| Low-frequency sound adjustment..... | 52 |
| M | |
| MAC Address Filter, Network setup | 106 |
| MACRO..... | 121 |
| Manual Preset..... | 66 |
| Manual Setup, Speaker setup | 96 |
| Manual Tuning, TUNER | 67 |
| Max Volume, Sound setup..... | 101 |
| Memory Guard, Function setup | 112 |
| Menu browse control | 77 |
| MONITOR CHECK, Advanced Setup menu | 127 |
| Monitor Out Assign, Multi Zone setup..... | 108 |
| Multi information display | 11 |
| Multi Zone setup | 107 |
| Multi-format player connection | 37 |
| Multi-zone function | 133 |
| MUTE indicator | 11 |

N

| | |
|--------------------------------------|-----|
| Network connection | 39 |
| NETWORK port | 39 |
| Network setup | 106 |
| Network Standby, Network setup | 106 |
| Network, Information menu..... | 114 |
| Normal tuning | 66 |
| Now Playing view | 65 |

O

| | |
|-------------------------|----|
| ON SCREEN menu..... | 59 |
| On-screen display | 14 |
| OPTICAL jack | 28 |
| Option menu | 61 |
| Option menu list..... | 62 |

P

| | |
|--|-----|
| Pairing, Option menu | 64 |
| Panorama, Sound Program menu..... | 94 |
| Parametric EQ, Speaker setup..... | 99 |
| Party mode | 136 |
| Party Mode Set, Multi Zone setup | 108 |
| PC..... | 69 |
| PHONES jack..... | 9 |
| Play Control, DOCK (iPod) | 78 |
| Play Control, Internet Radio | 74 |
| Play Control, PC..... | 70 |
| Play Control, USB..... | 72 |
| Power Amp Assign, Manual Setup, Speaker setup..... | 97 |
| PREOUT connection..... | 27 |
| Presence speaker | 15 |
| Presence speaker connection..... | 20 |
| Presence speaker layout | 17 |
| PRESET | 117 |
| Preset Select, TUNER | 68 |
| Pure Direct Mode | 56 |
| Pure Direct Mode, Sound setup | 101 |

R

| | |
|--|-----|
| Rear panel..... | 10 |
| Recording device connection | 39 |
| RECOV./BACKUP, Advanced Setup menu..... | 127 |
| Registering remote control codes..... | 117 |
| REMOTE CON AMP, Advanced Setup menu | 126 |
| Remote control | 12 |
| Remote control battery installation | 13 |
| Remote control connection..... | 38 |
| Remote control, Controlling other components | 115 |
| REMOTE SENSOR, Advanced Setup menu | 126 |
| RENAME | 120 |
| Rename/Icon Select, Input menu..... | 85 |
| Rename/Icon Select, Scene menu | 89 |
| Repeat, Option menu..... | 64 |
| Reset, Scene menu..... | 89 |
| Resetting all remote control codes | 117 |
| Resolution, Processing, Video setup | 102 |
| Reverb Delay, Sound Program menu | 92 |
| Reverb Level, Sound Program menu | 93 |
| Reverb Time, Sound Program menu | 92 |
| Room Size, Sound Program menu | 91 |

S

| | |
|---|-----|
| Save, Scene menu..... | 88 |
| SCENE function | 53 |
| Scene menu..... | 87 |
| Setting Data Copy, Manual Setup, Speaker setup..... | 96 |
| Setting Pattern, Manual Setup, Speaker setup..... | 96 |
| Setup menu | 95 |
| Setup menu list | 96 |
| Shortcut function | 75 |
| Shuffle, Option menu | 64 |
| SILENT CINEMA mode..... | 54 |
| Simple remote control | 78 |
| Simplified remote control..... | 124 |
| Sound program | 54 |
| Sound program list | 57 |
| Sound Program menu | 90 |
| Sound setup | 100 |



| | | | |
|---|--------|---|-----|
| Speaker connection | 15 | USB storage device connection | 40 |
| SPEAKER IMP., Advanced Setup menu | 125 | USB storage devices | 71 |
| Speaker indicators | 11 | Utility, TUNER | 68 |
| Speaker layout | 16, 23 | | |
| Speaker setting | 42 | V | |
| Speaker setup | 96 | VERSION, Advanced Setup menu | 128 |
| Standby Charge, Input menu | 86 | Video Adjustment, Option menu | 64 |
| Standby Through, HDMI setup | 105 | VIDEO jack | 28 |
| Straight decoding mode | 55 | Video Out, Input menu | 86 |
| Subwoofer | 15 | Video setup | 102 |
| Supplied accessories | 2 | Video Signal, Information menu | 113 |
| Surround Back Initial Delay, Sound Program menu | 91 | Virtual CINEMA DSP 3D mode | 55 |
| Surround Back L Level, Sound Program menu | 93 | Virtual CINEMA DSP mode | 54 |
| Surround Back Liveness, Sound Program menu | 92 | VOLUME | 8 |
| Surround Back R Level, Sound Program menu | 93 | VOLUME indicator | 11 |
| Surround Back Room Size, Sound Program menu | 91 | Volume Trim, Option menu | 64 |
| Surround back speaker | 15 | | |
| Surround Initial Delay, Sound Program menu | 91 | W | |
| Surround L Level, Sound Program menu | 93 | Web Control Center | 82 |
| Surround Liveness, Sound Program menu | 92 | | |
| Surround R Level, Sound Program menu | 93 | Y | |
| Surround Room Size, Sound Program menu | 91 | YPAO | 42 |
| Surround speaker | 15 | | |
| S-VIDEO jack | 28 | Z | |
| System, Information menu | 114 | ZONE OUT connection | 27 |
| | | Zone Rename, Multi Zone setup | 109 |
| T | | Zone Scene Rename, Multi Zone setup | 109 |
| Test Tone, Speaker setup | 100 | Zone, Information menu | 114 |
| Tone control | 52 | Zone2 Set, Multi Zone setup | 107 |
| Tone Control, Option menu | 63 | Zone3 Set, Multi Zone setup | 107 |
| Transmitter of the Wireless System for iPod | 78 | | |
| Trigger connection | 38 | | |
| Trigger Output, Function setup | 111 | | |
| Tuner indicator | 11 | | |
| TV Audio Input, HDMI setup | 105 | | |
| TV FORMAT, Advanced Setup menu | 127 | | |
| TV monitor connection | 29 | | |
| | | | |
| U | | | |
| USB port | 40 | | |





The latest firmware notification / La dernière notification du pare-feu / Meldung der neuesten Firmware-Version / Meddelande om senaste firmware / L'avviso per il firmware più recente

When the following notifications are displayed in the ON SCREEN menu **while this unit is connected to the network**, the firmware of this unit can be updated by using the Advanced Setup menu. Refer to "Firmware update" in the Owner's Manual for details on how to update the firmware.

Si les notifications suivantes sont affichées dans le menu ON SCREEN **alors que cet appareil est connecté au réseau**, le pare-feu de cet appareil peut être mis à jour à l'aide du menu Advanced Setup. Reportez-vous à la section « Mise à jour du pare-feu » dans le Mode d'emploi pour plus de détails concernant la manière de mettre à jour le pare-feu.

Wenn das ON SCREEN-Menü die unten stehenden Meldungen enthält **während dieses Gerät mit dem Netzwerk verbunden ist**, kann die Firmware dieses Geräts im Advanced Setup-Menü aktualisiert werden. Wie Sie die Firmware aktualisieren, ist unter „Firmware-Update“ in der Bedienungsanleitung beschrieben.

När följande meddelande visas på ON SCREEN-meny **medan receiveern är ansluten till nätverket**, kan firmware för receiveern uppdateras via Advanced Setup-meny. Se "Firmware-uppdatering" i Bruksanvisningen för mer information om hur man uppdaterar firmware.

Quando compaiono i seguenti avvisi nel menu ON SCREEN e l'unità è collegata alla rete, è possibile aggiornare il firmware dell'unità tramite il menu Advanced Setup. Fare riferimento a "Aggiornamento firmware" nel Manuale di istruzioni per maggiori dettagli su come aggiornare il firmware.

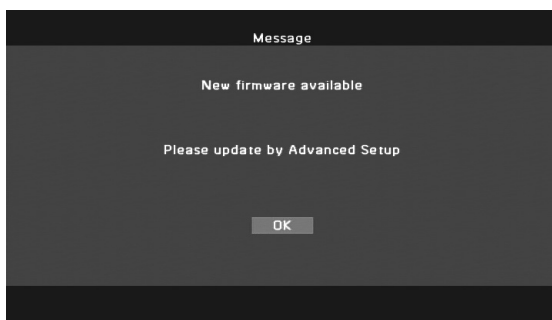

- When pressing ON SCREEN
- Lorsqu'on appuie sur ON SCREEN
- ON SCREEN gedrückt
- När ON SCREEN trycks ner
- Quando si preme ON SCREEN

↓ ENTER

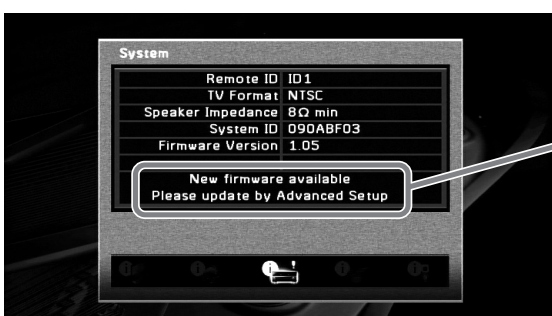
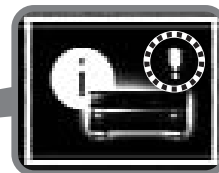
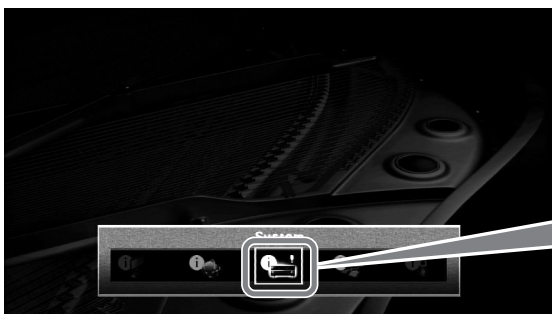
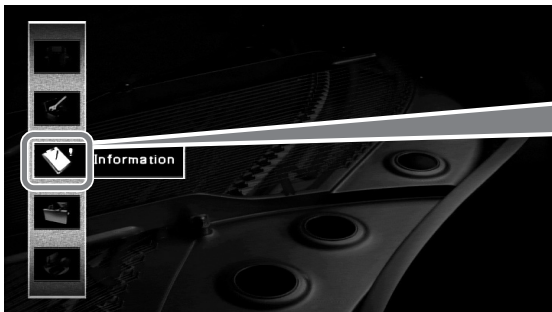

Message
Message
Meldung
Meddelande
Messaggio

Aviso sobre la última versión del firmware / De nieuwste firmware-kennisgeving / Уведомление о последнем встроенном программном обеспечении / 最新固件通知 / 최신 펌웨어 알림

Cuando los avisos siguientes aparecen en el menú ON SCREEN estando esta unidad conectada a la red, el firmware de esta unidad se puede actualizar utilizando el menú Advanced Setup. Consulte “Actualización del firmware” en el Manual de Instrucciones para conocer más detalles sobre cómo actualizar el firmware.

Wanneer de volgende kennisgevingen worden weergegeven in het ON SCREEN-menu als dit toestel is aangesloten op het netwerk, dan kan de firmware van dit toestel worden geupdate via het Advanced Setup menu. Raadpleeg “Firmware update” in de Gebruiksaanwijzing voor informatie over het updaten van de firmware.

При отображении следующих уведомлений в меню ON SCREEN, когда аппарат подсоединен к сети, встроенное программное обеспечение данного аппарата может быть обновлено с помощью меню Advanced Setup. Для получения подробной информации об обновлении встроенного программного обеспечения см. “Обновление встроенного программного обеспечения” в документе Инструкция по эксплуатации.

在本机连接至网络的情况下，如果在 ON SCREEN 菜单中显示以下通知，则可利用 Advanced Setup 菜单对本机的固件进行更新。请参见使用说明书中的“固件更新”，获取有关固件更新方法的详情。

이 장치를 네트워크에 연결할 때 ON SCREEN 메뉴에 다음의 알림 메시지가 표시되는 경우, Advanced Setup 메뉴를 사용하여 이 장치의 펌웨어를 업데이트할 수 있습니다. 펌웨어 업데이트 방법에 대한 자세한 내용은 사용 설명서에서 “펌웨어 업데이트”를 참조하십시오.

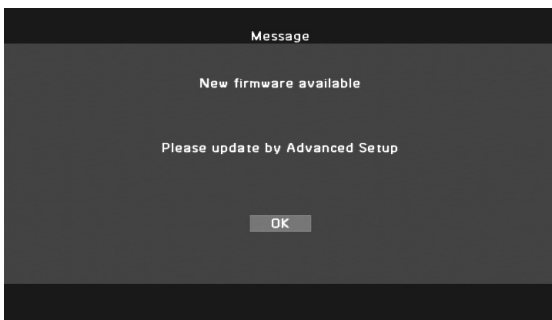

- AI pulsar ON SCREEN
- Bij drukken op ON SCREEN
- При нажатии ON SCREEN
- 按 ON SCREEN 时
- ON SCREEN 을 누를 경우

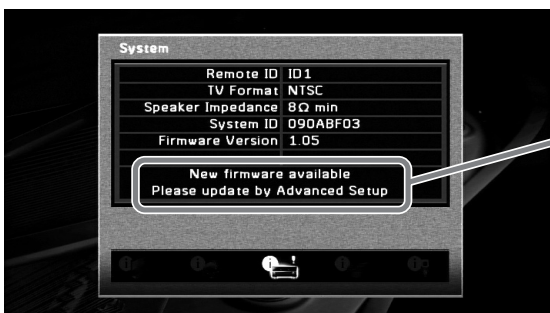
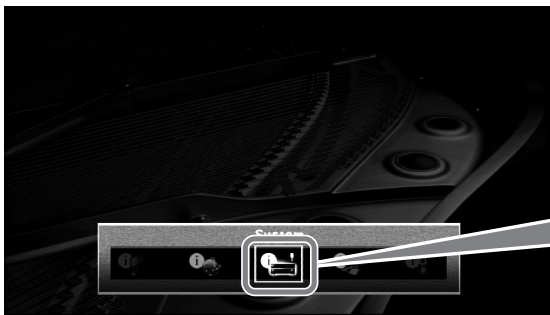
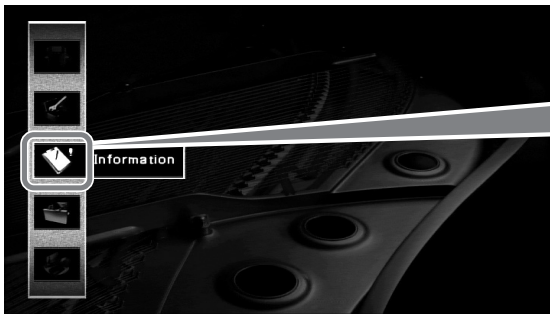

Mensaje
Bericht
Сообщение
信息
메시지

List of remote control codes
Liste des codes de commande
Liste der Fernbedienungscodes
Lista över fjärrstyrningskoder
Elenco dei codici di telecomando

Lista de códigos de mando a distancia
Lijst met afstandsbedieningscodes
Список кодов дистанционного управления
遥控器代码列表
리모콘코드목록

| | | | | | | | |
|----------------|--|----------------------|--|--------------------|--|------------------|--|
| TV | | Axion | 0156 | Condor | 0161, 0277, 0320, 0323, 0342, 0350, 0351 | Elin | 0277, 0320, 0323, 0342, 0349, 0350 |
| A.R. Systems | 0320 | Baird | 0282 | Contec | 0179, 0277, 0323, 0342, 0343, 0344 | Elite | 0320, 0340, 0350 |
| Acme | 0342 | Bang & Olufsen | 0180, 0339 | Contec/Cony | 0012, 0058 | Elman | 0341 |
| Acura | 0323, 0343 | Basic Line | 0282, 0320, 0323, 0340, 0343, 0350 | Continental Edison | 0345 | Elta | 0277, 0323, 0343 |
| ADC | 0337 | Bastide | 0282, 0342 | Cosmel | 0323, 0343 | Emerson | 0000, 0007, 0008, 0012, 0013, 0019, 0026, 0031, 0037, 0051, 0058, 0059, 0161, 0179, 0320, 0339 |
| Admiral | 0054, 0178, 0336, 0337, 0339, 0346, 0347 | Baur | 0320, 0349 | Craig | 0058, 0179 | Emprex | 0154 |
| Advent | 0158 | Bazin | 0282 | Crosley | 0010, 0037, 0171, 0339 | Envision | 0008, 0026, 0050 |
| Adventura | 0057 | Beko | 0161, 0269, 0294, 0302, 0311, 0320, 0328, 0351 | Crown | 0058, 0161, 0171, 0179, 0320, 0323, 0343, 0349, 0350, 0351 | Epson | 0155, 0206, 0359 |
| Adyson | 0277, 0282, 0342 | Belcor | 0008 | CS Electronics | 0277, 0340, 0342 | Erres | 0320, 0349, 0350 |
| Agashi | 0277, 0282 | Bell & Howell | 0019, 0054 | CTC Clatronic | 0341 | ESA | 0051 |
| Agazi | 0337 | Benq | 0097, 0242, 0361 | CTX | 0205 | ESC | 0282 |
| Aiko | 0277, 0282, 0320, 0323, 0342, 0343 | Beon | 0320, 0349, 0350 | Curtis Mathes | 0007, 0008, 0010, 0019, 0021, 0026, 0049, 0050, 0178 | Etron | 0343 |
| Aim | 0320 | Best | 0161 | CXC | 0058, 0179 | Eurofeel | 0282 |
| Aiwa | 0078, 0379 | Bestar | 0161, 0320, 0350 | Cybertron | 0340 | Euro-Feel | 0337 |
| Akai | 0050, 0055, 0109, 0159, 0181, 0277, 0282, 0320, 0323, 0340, 0343, 0349, 0350 | Binatone | 0282, 0342 | Cytron | 0152 | Euroline | 0349 |
| Akiba | 0320, 0340 | Blue Sky | 0320, 0340 | Daewoo | 0007, 0008, 0026, 0037, 0053, 0167, 0266, 0275, 0277, 0282, 0315, 0320, 0323, 0331, 0335, 0342, 0343, 0350, 0381, 0465 | Euroroman | 0161, 0277, 0282 |
| Akura | 0320, 0323, 0337, 0340 | Blue Star | 0348 | Dainichi | 0277, 0340 | Euromann | 0320, 0337, 0342, 0350 |
| Alaron | 0277 | Boots | 0282, 0342 | Dansai | 0277, 0282, 0320, 0337, 0349, 0350 | Expert | 0321 |
| Alba | 0161, 0277, 0320, 0323, 0340, 0342, 0343, 0344, 0349, 0351, 0372, 0382 | Bradford | 0058, 0179 | Dantax | 0161, 0349 | Exquisit | 0320 |
| Albatron | 0140 | Brandt | 0322, 0345 | Dawa | 0320 | Fenner | 0323, 0343 |
| Alcyon | 0171 | Brilliant | 0182 | Daytron | 0007, 0008, 0026, 0323, 0343 | Ferguson | 0322, 0345, 0349 |
| Alleron | 0059 | Brinkmann | 0320 | De Graaf | 0346 | Fidelity | 0277, 0320, 0342, 0346 |
| Allorgan | 0282 | Brionvega | 0320, 0339, 0349, 0350 | Decca | 0282, 0320, 0342, 0349, 0350 | Filex | 0282 |
| Allstar | 0320, 0350 | Britannia | 0277, 0282, 0342 | Dell | 0145, 0245 | Finlandia | 0346 |
| America Action | 0179 | Brockwood | 0008 | Denver | 0358, 0362 | Finlux | 0171, 0282, 0320, 0339, 0341, 0342, 0349, 0350 |
| AMOi | 0276 | Broksonic | 0109, 0179 | Desmet | 0320, 0349, 0350 | FIRST LINE | 0342, 0343, 0350 |
| Amplivision | 0161, 0282, 0321, 0342 | Bruns | 0339 | Diamant | 0320 | Firstline | 0277, 0282, 0320, 0323 |
| Amstrad | 0320, 0323, 0337, 0340, 0343 | BTC | 0340 | Diamond | 0277 | Fisher | 0019, 0161, 0282, 0339, 0342, 0344, 0351 |
| Amtron | 0058 | Bush | 0269, 0282, 0283, 0304, 0320, 0323, 0328, 0332, 0340, 0343, 0344, 0346, 0348, 0349, 0350, 0372, 0382, 0463, 0470, 0472 | DiamondVision | 0135, 0143 | Flint | 0320, 0350 |
| Anam | 0179, 0343 | Capsonic | 0337 | Dimensia | 0049 | Formenti | 0171, 0277, 0336, 0339, 0342, 0349 |
| Anam National | 0052, 0058 | Carena | 0320 | Disney | 0219 | Formenti/Phoenix | 0277 |
| Anglo | 0323, 0343 | Carnivale | 0050 | Dixi | 0282, 0320, 0323, 0343, 0349, 0350 | Fortress | 0366, 0339 |
| Anitech | 0171, 0320, 0323, 0337, 0343 | Carrefour | 0344 | Dream Vision | 0461, 0498 | Fraba | 0161, 0320 |
| Ansonic | 0161, 0168, 0320, 0323, 0341, 0343 | Carver | 0010 | DTS | 0323, 0343 | Friac | 0161 |
| AOC | 0008, 0026, 0050, 0053 | Cascade | 0320, 0323, 0343 | Dual | 0282, 0320, 0342 | Frontech | 0282, 0323, 0337, 0343, 0346, 0347 |
| Apex | 0039, 0111, 0217 | Casio | 0367 | Dual-Tec | 0342, 0343 | Fujitsu | 0059, 0069, 0074, 0075, 0282 |
| Arcam | 0277, 0282 | Cathay | 0320, 0349, 0350 | Dumont | 0008, 0030, 0062, 0282, 0339, 0341, 0342 | Fujitsu General | 0282 |
| Arcam Delta | 0342 | CCE | 0183, 0282 | Durabrand | 0031, 0051, 0179, 0215 | Fujitsu Siemens | 0504, 0505, 0507, 0510, 0511 |
| Aristona | 0320, 0349, 0350 | Celebrity | 0055, 0107 | Dux | 0349 | Funai | 0051, 0058, 0059, 0112, 0113, 0115, 0118, 0119, 0179, 0337 |
| Arthur Martin | 0321 | Celera | 0039 | Dwin | 0178 | Futuretech | 0058, 0179 |
| ASA | 0339, 0347 | Centurion | 0320, 0349, 0350 | Dynatron | 0320, 0349, 0350 | Galaxi | 0320, 0351 |
| Asberg | 0171, 0320, 0350 | Century | 0339 | Dynex | 0228, 0231 | Galaxis | 0161, 0320 |
| Astra | 0343 | CGE | 0161, 0171 | Elbe | 0161, 0168, 0282, 0320 | Gateway | 0176, 0177, 0241 |
| Asuka | 0277, 0282, 0337, 0340, 0342 | Changhong | 0039 | Elcit | 0339 | GBC | 0323, 0343, 0344 |
| Atlantic | 0277, 0320, 0342, 0349, 0350 | Chime | 0273 | Electa | 0348 | GE | 0008, 0021, 0023, 0026, 0027, 0031, 0034, 0049, 0052, 0056, 0209 |
| Atori | 0323, 0343 | Cimline | 0323, 0343 | ELECTRO TECH | 0343 | Geant Casino | 0321 |
| Auchan | 0321 | Citizen | 0007, 0008, 0026, 0050, 0058 | Electroband | 0055, 0107 | GEC | 0282, 0320, 0342, 0347, 0349, 0350 |
| Audiosonic | 0161, 0282, 0320, 0340, 0342, 0343, 0349, 0350 | City | 0323, 0343 | Electrograph | 0176 | Geloso | 0323, 0343, 0346 |
| AudioTon | 0161, 0282, 0342 | Clarion | 0179 | Electrohome | 0008, 0026, 0052, 0055 | General Technic | 0323, 0343 |
| Audiovox | 0058, 0179, 0194 | Clarivox | 0349 | Element | 0230 | | |
| Ausind | 0171 | Clatronic | 0161, 0171, 0282, 0320, 0323, 0337, 0340, 0342, 0343, 0350, 0351 | | | | |
| Autovox | 0171, 0282, 0337, 0339, 0342 | CMS | 0277 | | | | |
| Aventura | 0051 | CMS Hightec | 0282 | | | | |
| Awa | 0277, 0282 | Coby | 0197 | | | | |
| | | Colortyme | 0008, 0026 | | | | |
| | | Commercial Solutions | 0021 | | | | |
| | | Concerto | 0008, 0026 | | | | |
| | | Concorde | 0323, 0343 | | | | |

| | | | | | | | |
|-----------------|--|----------------|--|-----------------|--|--------------|--|
| Genexxa | 0320, 0340, 0347, 0350 | Infinity | 0010 | Lifetec | 0320, 0323, 0337, 0343 | Multitech | 0058, 0161, 0179, 0183, 0277, 0282, 0320, 0323, 0341, 0342, 0343, 0344, 0346, 0349 |
| GFM | 0128, 0227 | InFocus | 0250, 0327, 0363, 0479, 0508 | Lloyds | 0323 | | |
| Giant | 0282 | Ingelen | 0347 | Loewe | 0161, 0168, 0265, 0320, 0330, 0352 | | |
| Gibraltar | 0008, 0030, 0050, 0062 | Ingersol | 0323, 0343 | Loewe Opta | 0339, 0349, 0350 | Murphy | 0277, 0342 |
| GoldHand | 0277 | Initial | 0153 | Logik | 0054 | NAD | 0026, 0031, 0111 |
| Goldline | 0320 | Inno Hit | 0171, 0282, 0320, 0323, 0340, 0342, 0343, 0349, 0350 | Luma | 0320, 0323, 0346, 0349 | Naonis | 0346 |
| GoldStar | 0007, 0008, 0012, 0026, 0031, 0050, 0053, 0161, 0277, 0282, 0320, 0323, 0342, 0343, 0346, 0349, 0350 | Innovation | 0337, 0343 | Lumatron | 0282, 0320, 0346, 0349, 0350 | NEC | 0008, 0026, 0050, 0052, 0053, 0072, 0103, 0282, 0344 |
| | | Insignia | 0131, 0228, 0236, 0238 | Lux May | 0350 | Neckermann | 0161, 0282, 0320, 0339, 0342, 0346, 0349, 0350, 0351 |
| Goodmans | 0246, 0272, 0282, 0320, 0323, 0337, 0343, 0344, 0349, 0350, 0462, 0473, 0477 | Inteq | 0030 | Luxman | 0008, 0026 | | |
| | | Interactive | 0161 | Luxor | 0282, 0342, 0346 | NEI | 0320, 0349, 0350 |
| | | Interbuy | 0323, 0343 | LXI | 0010, 0019, 0021, 0026, 0027, 0031, 0049, 0111 | Net-TV | 0176 |
| | | Interfunk | 0161, 0320, 0339, 0347, 0349, 0350 | M Electronic | 0342, 0343, 0345, 0347, 0349, 0350 | Neufunk | 0320, 0323 |
| | | International | 0277 | | | New Tech | 0343, 0350 |
| | | Intervision | 0161, 0282, 0320, 0337, 0341, 0342 | MAG | 0096 | New World | 0340 |
| Gorenje | 0161, 0351 | Irradio | 0171, 0320, 0323, 0340, 0343, 0349, 0350 | Magnadyne | 0339, 0341, 0349 | NewTech | 0282, 0320, 0323 |
| GPM | 0340 | | | Magnafon | 0171, 0277, 0341, 0342 | Nicamagic | 0277, 0342 |
| GPX | 0129 | | | | | Nikkai | 0277, 0282, 0320, 0323, 0337, 0340, 0342, 0349, 0350 |
| Gradiente | 0240 | Isukai | 0320, 0340 | Magnavox | 0008, 0009, 0010, 0013, 0026, 0032, 0033, 0048, 0050, 0128, 0211, 0212, 0224, 0226, 0239 | Nikko | 0342, 0349, 0350 |
| Graetz | 0347 | ITC | 0282, 0342 | | | Nobliko | 0171, 0277, 0341, 0342 |
| Granada | 0171, 0282, 0320, 0321, 0342, 0344, 0346, 0349, 0350 | ITS | 0277, 0320, 0340, 0348, 0350 | | | Nokia | 0347 |
| Grandin | 0340, 0343, 0348, 0349 | ITT | 0343, 0347 | Magnum | 0337, 0343 | Norcent | 0201 |
| Gronic | 0282 | ITV | 0320, 0343, 0349 | Majestic | 0054 | Nordic | 0282 |
| Grundig | 0160, 0161, 0171, 0310, 0320 | Janeil | 0057 | Mandor | 0337 | Nordmende | 0339, 0345, 0347, 0350 |
| Grunpy | 0058, 0059, 0179 | JBL | 0010 | Manesth | 0282, 0320, 0337, 0342, 0349, 0350 | Nordvision | 0349 |
| Haier | 0157, 0233 | JC Penney | 0007, 0008, 0026, 0027, 0049, 0053, 0056 | Marantz | 0008, 0010, 0026, 0050, 0204, 0320, 0349, 0350 | Novatronic | 0320 |
| Halifax | 0277, 0282, 0337, 0342 | JCB | 0055, 0107 | | | Oceanic | 0321, 0347 |
| Hallmark | 0008, 0026, 0031 | Jensen | 0008, 0026 | Marelli | 0339 | Okano | 0161, 0320, 0351 |
| Hampton | 0277, 0282, 0342 | JVC | 0012, 0014, 0015, 0056, 0064, 0065, 0067, 0169, 0174, 0297, 0314, 0344, 0350, 0375 | Mark | 0277, 0282, 0320, 0323, 0349, 0350 | Olevia | 0102, 0199, 0200, 0207, 0222 |
| Hanseatic | 0161, 0168, 0282, 0320, 0323, 0342, 0343, 0344, 0349, 0350 | | | Masuda | 0282 | ONCEAS | 0342 |
| | | Kaisui | 0277, 0282, 0320, 0323, 0340, 0342, 0343, 0348 | Matsui | 0282, 0320, 0323, 0342, 0343, 0344, 0346, 0349, 0350, 0455 | Onwa | 0058, 0179 |
| Hantarex | 0320, 0323, 0343 | | | Matsushita | 0017 | Opera | 0320 |
| Hantor | 0320 | Kamosonic | 0342 | Maxent | 0147, 0176 | Oppo | 0130 |
| Harman/Kardon | 0010 | Kamp | 0277, 0342 | Mediator | 0320, 0349, 0350 | Optimus | 0017, 0019 |
| Harvard | 0058, 0179 | Kapsch | 0347 | Medion | 0320, 0337, 0343 | Optoma | 0144 |
| Harwood | 0320, 0323 | Karcher | 0161, 0320, 0342, 0343, 0349 | Megapower | 0140 | Optonica | 0178 |
| Havermy | 0178 | | | Megatron | 0026, 0031 | Orbit | 0320, 0350 |
| HCM | 0282, 0320, 0323, 0337, 0342, 0343, 0348 | Kawasho | 0008, 0026, 0055, 0277 | MElectronic | 0277, 0282, 0320, 0323 | Orion | 0043, 0146, 0283, 0320, 0323, 0328, 0343, 0349, 0350 |
| Hema | 0282, 0323 | KEC | 0179 | | | Orline | 0320 |
| Hewlett Packard | 0192 | Kendo | 0161, 0320, 0341, 0346 | Melvox | 0321 | Osaki | 0282, 0320, 0337, 0340, 0342 |
| Higashi | 0277 | | | Memorex | 0019, 0026, 0031, 0053, 0054, 0137, 0215, 0323, 0343 | Oso | 0340 |
| HiLine | 0320 | Kenwood | 0008, 0026, 0050 | | | Otto Versand | 0282, 0320, 0336, 0342, 0344, 0348, 0349, 0350 |
| Hinari | 0320, 0323, 0340, 0343, 0344, 0349, 0350 | KIC | 0282 | Memphis | 0323, 0343 | Pael | 0277, 0342 |
| | | Kingsley | 0277, 0342 | Mercury | 0320, 0323 | Palladium | 0161, 0282, 0320, 0342, 0351 |
| | | KLH | 0039 | Metz | 0339 | | |
| Hisawa | 0321, 0340, 0348 | Kloss Novabeam | 0057, 0058 | MGA | 0008, 0026, 0031, 0050, 0053 | Palsonic | 0282 |
| Hisense | 0247 | Kneissel | 0161, 0168, 0320 | | | Panama | 0277, 0282, 0320, 0323, 0337, 0342, 0343 |
| Hitachi | 0008, 0012, 0026, 0066, 0084, 0092, 0093, 0120, 0172, 0173, 0255, 0270, 0271, 0282, 0320, 0335, 0338, 0342, 0344, 0346, 0347, 0365, 0382, 0448, 0456, 0467 | Kolster | 0320, 0350 | Micromaxx | 0337, 0343 | Panasonic | 0016, 0017, 0020, 0022, 0023, 0035, 0052, 0056, 0084, 0085, 0133, 0163, 0193, 0284, 0286, 0290, 0292, 0320, 0325, 0347, 0356 |
| | | Korpel | 0320, 0349, 0350 | Microstar | 0337, 0343 | | |
| | | Korting | 0161, 0339 | Midland | 0007, 0021, 0023, 0027, 0030, 0056, 0062 | | |
| | | Kosmos | 0320 | | | | |
| | | Koyoda | 0343 | Minerva | 0171 | | |
| | | KTV | 0007, 0050, 0058, 0179, 0183, 0282, 0342 | Minoka | 0320, 0350 | | |
| | | | | Mintek | 0153 | | |
| Hornymphon | 0320, 0350 | Kyoto | 0277, 0282 | Mitsubishi | 0008, 0026, 0031, 0053, 0066, 0084, 0093, 0098, 0150, 0178, 0289, 0320, 0339, 0344, 0350, 0376 | | |
| Hoshai | 0340 | Lasat | 0161 | | | | |
| Huanyu | 0277, 0342 | Lenco | 0323, 0343 | Mivar | 0161, 0168, 0171, 0277, 0282, 0342 | Panavision | 0320 |
| Hygashi | 0277, 0282, 0342 | Lenoir | 0323, 0342, 0343 | | | Pathe Cinema | 0161, 0168, 0277, 0321, 0342 |
| Hyper | 0277, 0282, 0323, 0342, 0343 | Leyco | 0320, 0337, 0349, 0350 | | | Pausa | 0323, 0343 |
| Hypson | 0282, 0320, 0321, 0337, 0342, 0348, 0349, 0350 | LG | 0031, 0053, 0066, 0116, 0117, 0140, 0161, 0164, 0175, 0195, 0269, 0277, 0282, 0300, 0309, 0317, 0320, 0323, 0328, 0342, 0343, 0346, 0349, 0350, 0366, 0368, 0377, 0466, 0471, 0478 | | | Penney | 0021, 0023, 0031, 0050, 0111 |
| Hyundai | 0141 | | | Monivision | 0140 | Perdio | 0277, 0320 |
| Iberia | 0320 | | | Montgomery Ward | 0054 | Perfekt | 0320 |
| ICE | 0277, 0282, 0320, 0323, 0337, 0340, 0342, 0343, 0350 | | | | | Philco | 0008, 0009, 0010, 0012, 0026, 0050, 0052, 0053, 0161, 0171, 0320, 0339 |
| ICeS | 0277 | | | Motion | 0171 | Philharmonic | 0282, 0342 |
| Ilo | 0148, 0153 | | | Motorola | 0052, 0178 | Philips | 0008, 0009, 0010, 0011, 0012, 0032, 0048, 0049, 0052, 0122, 0128, 0134, 0186, 0187, 0213, 0221, 0224, 0226, |
| IMA | 0058 | LG/GoldStar | 0164 | MTC | 0008, 0026, 0050, 0053, 0161, 0277 | | |
| Imperial | 0161, 0171, 0320, 0347, 0350, 0351 | Liesenk | 0349 | | | | |
| Indiana | 0320, 0349, 0350 | Liesenkotter | 0320 | Multi System | 0349 | | |
| | | Life | 0337, 0343 | | | | |

| | | | | | | | |
|----------------------|--|--|--|--|---|--|--|
| | 0239, 0256, 0257, 0259, 0261, 0263, 0267, 0280, 0281, 0287, 0296, 0299, 0301, 0303, 0305, 0313, 0319, 0320, 0324, 0333, 0339, 0342, 0349, 0350, 0353, 0357, 0360, 0380, 0383, 0452, 0459, 0460 | | Robotron 0339 | | Sonoko 0282, 0320, 0323, 0337, 0342, 0343, 0349, 0350 | | Tesmet 0350 |
| | | | Rowa 0277, 0282 | | Sonolor 0321, 0347 | | Tevion 0337, 0343 |
| | | | Royal Lux 0161 | | Sontec 0161, 0320, 0349, 0350 | | Textet 0277, 0282, 0323, 0342 |
| | | | RTF 0339 | | Sony 0038, 0044, 0045, 0047, 0055, 0104, 0105, 0107, 0110, 0123, 0184, 0220, 0248, 0249, 0251, 0252, 0254, 0326, 0343, 0344, 0371, 0374, 0457, 0475 | | Thomson 0162, 0188, 0189, 0285, 0320, 0322, 0342, 0345, 0350 |
| | | | Runco 0030, 0050, 0062 | | Sound & Vision 0340, 0341 | | Thorn 0320, 0349 |
| | | | Saba 0298, 0322, 0339, 0345, 0347 | | Soundesign 0008, 0026, 0031, 0058, 0059, 0179 | | TMK 0008, 0026, 0031 |
| | | | Saisho 0282, 0323, 0337, 0342, 0343 | | Soundwave 0320, 0349, 0350 | | TNCi 0030 |
| | | | Salora 0346, 0347 | | Squareview 0051 | | Tokai 0282, 0320, 0350 |
| | | | Sambers 0171, 0341 | | SSS 0008, 0058, 0179 | | Tokyo 0277, 0342 |
| | | | Sampo 0007, 0008, 0026, 0050, 0176 | | Standard 0282, 0320, 0323, 0340, 0342, 0343, 0350 | | Tomashi 0348 |
| Philips Magnavox | 0011, 0032, 0033 | | Samsung 0004, 0005, 0006, 0007, 0008, 0012, 0026, 0031, 0036, 0050, 0053, 0076, 0077, 0079, 0114, 0124, 0125, 0126, 0127, 0139, 0161, 0183, 0185, 0190, 0191, 0258, 0264, 0277, 0282, 0320, 0323, 0334, 0337, 0342, 0343, 0349, 0350, 0351, 0373, 0453, 0468 | | Starlite 0058, 0179, 0320, 0323, 0349 | | Toshiba 0018, 0019, 0040, 0041, 0046, 0073, 0100, 0103, 0108, 0109, 0111, 0121, 0132, 0166, 0208, 0210, 0214, 0217, 0260, 0268, 0282, 0283, 0293, 0304, 0306, 0307, 0329, 0344, 0355, 0454 |
| Phoenix | 0161, 0277, 0320, 0339, 0349, 0350 | | Sandra 0277, 0282, 0342 | | Stenway 0348 | | Totevision 0007 |
| Phonola | 0007, 0008, 0050 | | Sansui 0043, 0109, 0320, 0350 | | Stern 0346, 0347 | | Towada 0282, 0347 |
| Pilot | 0008, 0026, 0094, 0095, 0161, 0320, 0345, 0347, 0349, 0350, 0458 | | Sanyo 0008, 0019, 0068, 0070, 0071, 0099, 0161, 0168, 0223, 0237, 0277, 0282, 0288, 0295, 0323, 0342, 0344, 0369, 0469 | | Strato 0320, 0323 | | Trakton 0282 |
| Pioneer | 0007, 0008, 0050 | | SBR 0320, 0349 | | Stylandia 0282 | | Trans Continen 0282, 0320 |
| Plantron | 0320, 0323, 0337, 0350 | | Sceptre 0235, 0244 | | Sunkai 0343 | | Transtec 0277 |
| Playsonic | 0282 | | Schaub Lorenz 0347 | | Sunstar 0320, 0323 | | Trident 0282 |
| Polaroid | 0039, 0142, 0202, 0234 | | Schneider 0282, 0316, 0318, 0320, 0333, 0340, 0342, 0349, 0350, 0382 | | Sunwood 0320, 0323, 0343, 0350 | | Triumph 0320 |
| Poppy | 0323, 0343 | | Scotch 0026, 0031 | | Superla 0277, 0282, 0342 | | Uher 0161, 0171, 0320, 0347, 0350 |
| Portland | 0007, 0008, 0026, 0053 | | Scott 0008, 0012, 0026, 0031, 0058, 0059, 0149, 0179 | | Superscan 0013, 0178 | | Ultravox 0277, 0320, 0339, 0341, 0342 |
| Prandoni-Prince | 0171, 0346 | | Sears 0008, 0010, 0019, 0021, 0026, 0027, 0031, 0049, 0051, 0059, 0111 | | SuperTech 0277, 0320, 0323 | | Unic Line 0320 |
| Precision | 0282, 0342 | | SEG 0277, 0282, 0320, 0323, 0337, 0341, 0342, 0344, 0349, 0382 | | Supra 0323, 0343 | | United 0349 |
| Prima | 0157, 0243, 0323, 0343, 0347 | | SEI 0320 | | Supre-Macy 0057 | | Universum 0161, 0171, 0282, 0320, 0337, 0349, 0350, 0351 |
| Princeton | 0140 | | SEI-Sinudyne 0339, 0341, 0347 | | Supreme 0055, 0107 | | Univox 0320 |
| Prism | 0023, 0056 | | Seleco 0344, 0346, 0347 | | Susumu 0340 | | Vector Research 0050 |
| Profex | 0323, 0343 | | Sencora 0323, 0343 | | Sutron 0323, 0343 | | Vestel 0282, 0320, 0346, 0347, 0349, 0350, 0351 |
| Profi-Tronic | 0320, 0350 | | Sentra 0323 | | SVA 0151 | | Vexa 0320, 0323, 0343, 0349 |
| Proline | 0320, 0350 | | Serino 0277 | | Sydney 0277, 0282, 0342 | | Victor 0015, 0344, 0350 |
| Proscan | 0021, 0027, 0049 | | Sharp 0000, 0001, 0002, 0003, 0007, 0008, 0012, 0026, 0060, 0088, 0089, 0091, 0138, 0165, 0170, 0178, 0198, 0229, 0262, 0278, 0279, 0291, 0308, 0312, 0336, 0344, 0354, 0370, 0449, 0450, 0451, 0464, 0474, 0476 | | Sylvania 0008, 0009, 0010, 0011, 0013, 0026, 0048, 0050, 0051, 0128, 0227, 0253 | | VIDEOLOGIC 0277 |
| Prosonic | 0161, 0277, 0282, 0320, 0342, 0349 | | Sheng Chia 0178 | | Symphonic 0051, 0058, 0062, 0128, 0179, 0215 | | Videologique 0277, 0282, 0340, 0342 |
| Protech | 0282, 0337, 0341, 0342, 0343, 0349, 0350 | | Shogun 0008 | | Syntax 0199 | | VideoSystem 0320, 0350 |
| Proton | 0008, 0012, 0026, 0031 | | Siarem 0320, 0339, 0341 | | Syntax-Brilliant 0199 | | Videotechnic 0277, 0282 |
| Protron | 0196 | | Sierra 0320, 0350 | | Syline 0349 | | Vidikron 0010 |
| PROVIEW | 0096, 0246 | | Siesta 0161 | | Sytong 0277 | | Vidtech 0008, 0026, 0031, 0053 |
| Provision | 0320, 0349 | | Signature 0054 | | Tandy 0178, 0282, 0336, 0340, 0342, 0347 | | Viewsonic 0176, 0203, 0232, 0364 |
| Pulsar | 0008, 0030, 0062 | | Silva 0277 | | Tashiko 0277, 0282, 0342, 0344, 0346 | | Viking 0057 |
| Pye | 0256, 0320, 0349, 0350, 0378 | | Silver 0344 | | Tatung 0052, 0177, 0282, 0320, 0342, 0349, 0350 | | Viore 0148 |
| Pymi | 0323, 0343 | | Singer 0321, 0339, 0341 | | TCM 0337, 0343 | | Visiola 0277, 0342 |
| Quandra Vision | 0321 | | Sinudyne 0320, 0339, 0341, 0349 | | Teac 0282, 0320 | | Vision 0282, 0320, 0350 |
| Quasar | 0017, 0023, 0052, 0056 | | Sonitron 0161, 0282 | | Tec 0282, 0323, 0342, 0343 | | Vizio 0008, 0177, 0218, 0242, 0500, 0501, 0502, 0503, 0506 |
| Quelle | 0282, 0320, 0337, 0342, 0349, 0350 | | | | Technics 0017, 0023, 0056 | | Vortec 0320, 0349, 0350 |
| Questa | 0344 | | | | TechniSat 0274, 0496, 0497, 0499 | | Voxson 0171, 0320, 0339, 0346, 0347, 0350 |
| Radialva | 0320 | | | | Techwood 0008, 0023, 0026, 0056 | | Waltham 0282, 0320, 0342 |
| RadioShack | 0019, 0021, 0031, 0050, 0179, 0320 | | | | TEDELEX 0282 | | Wards 0008, 0009, 0010, 0026, 0031, 0048, 0049, 0050, 0053, 0054, 0059 |
| RadioShack/Realistic | 0007, 0008, 0012, 0026, 0049, 0058 | | | | Teknika 0007, 0008, 0010, 0012, 0026, 0053, 0054, 0058, 0059, 0179 | | Watson 0320, 0349, 0350 |
| Radiola | 0282, 0320, 0349, 0350 | | | | Teleavia 0345 | | Watt Radio 0277, 0341, 0342 |
| Radiomarelli | 0320, 0339 | | | | Telecor 0282, 0320 | | Waycon 0111 |
| Radiotone | 0161, 0320, 0323, 0350 | | | | Telefunken 0320, 0322, 0345, 0350 | | Wega 0320, 0339, 0344 |
| Rank | 0344 | | | | Telegazi 0320 | | Wegavox 0323 |
| RCA | 0008, 0021, 0024, 0025, 0026, 0027, 0042, 0049, 0052, 0053, 0063, 0136, 0225 | | | | Telemeister 0320 | | Weltblick 0282, 0320, 0349, 0350 |
| Realistic | 0019, 0031, 0050, 0179 | | | | Telestarc 0320 | | Westinghouse 0107, 0216, 0220 |
| Recor | 0320 | | | | Teletech 0320, 0323, 0343, 0349 | | White Westinghouse 0037, 0090, 0277, 0320, 0341, 0342, 0349 |
| Redstar | 0320 | | | | Teleton 0282, 0342 | | Wincom 0101, 0106 |
| Reflex | 0320 | | | | Televideon 0277 | | Xrypton 0320 |
| Revox | 0161, 0320, 0349, 0350 | | | | Televiso 0321 | | |
| Rex | 0337, 0346, 0347 | | | | Tensai 0282, 0320, 0323, 0340, 0343, 0350 | | |
| RFT | 0161, 0168, 0339 | | | | | | |
| Rhapsody | 0277 | | | | | | |
| R-Line | 0320, 0349, 0350 | | | | | | |
| Roadstar | 0323, 0337, 0340, 0343 | | | | | | |

| | | | | | | | |
|---------|--|------------------------|--|-----------------|--|----------------------|--|
| Yamaha | 0008, 0026, 0050, 0053, 0080, 0081, 0082, 0083, 0086, 0087 | DIRECTV | 1019, 1105, 1110, 1111, 1113, 1116, 1122 | Interfunk | 1028 | Otto Versand | 1028 |
| Yamishi | 0282, 0320 | Dish Network | 1018 | Intervision | 1009, 1026 | Palladium | 1008, 1027, 1029, 1031 |
| Yokan | 0320 | Dishpro | 1018 | Irradio | 1008, 1029, 1031 | Panasonic | 1000, 1022, 1044, 1055, 1068, 1072, 1085, 1090, 1091, 1120, 1121, 1214 |
| Yoko | 0161, 0277, 0282, 0320, 0323, 0337, 0340, 0342, 0343, 0349, 0350 | Dual | 1009, 1027, 1028 | ITT | 1027 | Pathe Marconi | 1027 |
| Yorx | 0340 | Dumont | 1026, 1028 | ITV | 1009, 1025, 1031 | Perdio | 1026 |
| Zanussi | 0282, 0346 | Durabrand | 1114 | JC Penney | 1064, 1065, 1068, 1070, 1071 | Philco | 1008, 1068 |
| Zenith | 0008, 0028, 0029, 0030, 0031, 0054, 0061, 0062 | Dynatech | 1069 | JCL | 1068 | Philips | 1006, 1013, 1028, 1035, 1040, 1045, 1046, 1050, 1058, 1059, 1061, 1068, 1076, 1101, 1110, 1113, 1116, 1117, 1122, 1126, 1210, 1211 |
| | | Echostar | 1018 | JVC | 1007, 1018, 1027, 1039, 1064, 1065, 1066, 1067, 1078, 1089, 1092, 1093, 1094, 1095, 1113, 1208, 1209, 1212, 1213, 1215, 1218 | Philips Magnavox | 1076 |
| | | Elbe | 1009 | Kaisui | 1008, 1029 | Phonola | 1028 |
| | | Elcatech | 1008 | Karcher | 1028 | Pilot | 1071 |
| | | Electrohome | 1071 | Kendo | 1008, 1024, 1025, 1030 | Pioneer | 1028, 1036 |
| | | Electroponic | 1071 | Kenwood | 1027, 1064, 1065 | Polaroid | 1088, 1099 |
| | | Elsay | 1008 | Kodak | 1068, 1071 | Portland | 1009, 1025, 1030 |
| | | Elta | 1008, 1009, 1029 | Korpel | 1008, 1029 | Prinz | 1026 |
| | | Emerson | 1008, 1020, 1068, 1069, 1071 | Kyoto | 1008 | Profex | 1029 |
| | | ESC | 1009, 1025 | Lenco | 1025 | Proline | 1026 |
| | | Etzuko | 1008, 1029 | Leyco | 1008, 1029 | Proscan | 1019 |
| | | Expressvu | 1018 | LG | 1010, 1026, 1031, 1047, 1054, 1056, 1071, 1103, 1221 | Prosonic | 1009, 1024 |
| | | Ferguson | 1027 | Lifetec | 1024 | Pulsar | 1114 |
| | | Fidelity | 1008, 1026 | Linksys | 1016 | Pye | 1028, 1102 |
| | | Finlandia | 1028 | Lloyd's | 1069 | Quarter | 1065 |
| | | Finlux | 1026, 1027, 1028 | Loewe Opta | 1028, 1031 | Quartz | 1065 |
| | | Firstline | 1008, 1024, 1029, 1031 | Logik | 1008, 1029 | Quasar | 1068 |
| | | Fisher | 1065 | Lumatron | 1009, 1025 | Quelle | 1026, 1028 |
| | | Flint | 1024 | Luxor | 1008 | Radialva | 1008 |
| | | Formenti/Phoenix | 1028 | LXI | 1071 | RadioShack | 1071 |
| | | Frontech | 1030 | M Electronic | 1026 | RadioShack/Realistic | 1065, 1068, 1069, 1070, 1071 |
| | | Fuji | 1068 | Magnavox | 1020, 1068, 1114, 1126 | Radiola | 1028 |
| | | Fujitsu | 1026 | Magnin | 1071 | Radix | 1071 |
| | | Funai | 1026, 1069 | Manesth | 1008, 1029 | Randex | 1071 |
| | | Galaxy | 1026 | Marantz | 1028, 1064, 1065, 1068 | RCA | 1019, 1068, 1070, 1075, 1110, 1113, 1122, 1125 |
| | | Garrard | 1069 | Mark | 1009 | Realistic | 1065, 1068, 1069, 1070, 1071 |
| | | Gateway | 1016 | Marta | 1071 | ReplayTV | 1022, 1123 |
| | | GBC | 1029, 1030 | Matsui | 1024, 1031 | Rex | 1027 |
| | | GE | 1068, 1070 | Matsushita | 1068 | RFT | 1008, 1028, 1030 |
| | | GEC | 1028 | Media Center PC | 1016 | Ricavision | 1016 |
| | | Geloso | 1029 | Mediator | 1028 | Roadstar | 1008, 1009, 1025, 1029, 1031 |
| | | General | 1030 | Medion | 1024 | Royal | 1008 |
| | | General Technic | 1024 | MEI | 1068 | Runco | 1114 |
| | | GOI | 1018 | Memorex | 1023, 1026, 1031, 1065, 1068, 1069, 1070, 1071, 1098, 1114 | Saba | 1027 |
| | | GoldHand | 1008, 1029 | Memphis | 1008, 1029 | Saisho | 1024, 1029 |
| | | Goldstar | 1026, 1031, 1064, 1071 | MGN Technology | 1070 | Samsung | 1002, 1034, 1041, 1043, 1057, 1060, 1070, 1084, 1110, 1116, 1122, 1124, 1220, 1222 |
| | | Goodmans | 1008, 1009, 1025, 1026, 1029, 1030, 1031 | Micromaxx | 1024 | Samurai | 1008, 1030 |
| | | Gradiente | 1069 | Microsoft | 1016 | Sanky | 1114 |
| | | Graetz | 1027 | Microrstar | 1024 | Sansui | 1023, 1027, 1106, 1115 |
| | | Granada | 1028 | Migros | 1026 | Sanyo | 1032, 1065, 1070 |
| | | Grandin | 1008, 1009, 1025, 1026, 1029, 1030, 1031 | Mind | 1016 | Saville | 1009 |
| | | Grundig | 1028, 1029 | Mitsubishi | 1026, 1028, 1079 | SBR | 1028 |
| | | Hanseatic | 1009, 1028, 1031 | Motorola | 1068 | Schaub Lorenz | 1026, 1027 |
| | | Harley Davidson | 1069 | MTC | 1070 | Schneider | 1008, 1009, 1024, 1025, 1026, 1028, 1029, 1030, 1031 |
| | | Harman/Kardon | 1064 | Multitech | 1008, 1026, 1028, 1029, 1030, 1069, 1070 | Sears | 1065, 1068, 1071 |
| | | Harwood | 1008 | Murphy | 1026 | SEG | 1008, 1009, 1029 |
| | | HCM | 1008, 1029 | NEC | 1027, 1064, 1065 | SEI-Sinudyne | 1028 |
| | | Headquarter | 1065 | Neckermann | 1027, 1028 | Seleco | 1027 |
| | | Hewlett Packard | 1016 | NEI | 1028 | Sentra | 1008, 1030 |
| | | Hinari | 1008, 1009, 1024, 1029 | Nesco | 1008, 1029 | Sentron | 1008, 1029 |
| | | Hisawa | 1024 | Nikkai | 1008, 1009, 1030 | Sharp | 1003, 1033, 1077, 1107, 1127, 1219 |
| | | Hitachi | 1011, 1026, 1027, 1028, 1046, 1062 | Nikko | 1071 | Shintom | 1008, 1029 |
| | | HNS | 1110 | Niveus Media | 1016 | Shivaki | 1031 |
| | | Howard Computers | | Noblex | 1070 | Shogun | 1070 |
| | | HP | 1016 | Nokia | 1009, 1027 | Siemens | 1031 |
| | | HTS | 1018 | Northgate | 1016 | Silva | 1031 |
| | | Hughes | 1111, 1113, 1122 | Oceanic | 1026, 1027 | Silver | 1009 |
| | | Hughes Network Systems | 1110, 1116 | Okano | 1008, 1009, 1024 | Singer | 1068 |
| | | Humax | 1012, 1110, 1113 | Olympus | 1068 | | |
| | | Hush | 1016 | Optimus | 1071 | | |
| | | Hypson | 1008, 1009, 1024, 1029 | Orion | 1023, 1024, 1051, 1115, 1217 | | |
| | | iBUYPOWER | 1016 | Orson | 1026 | | |
| | | Impego | 1030 | Osaki | 1008, 1026, 1029, 1031 | | |
| | | Imperial | 1026 | | | | |
| | | Inno Hit | 1008, 1009, 1025, 1028, 1029, 1030 | | | | |
| | | Innovation | 1024 | | | | |
| | | Instant Replay | 1068 | | | | |
| | | Interbuy | 1008, 1031 | | | | |

VCR

| | | | | | | | |
|--------------------|--|--|--|--|--|--|--|
| ABS | 1016 | | | | | | |
| Adventura | 1069 | | | | | | |
| Adyson | 1008 | | | | | | |
| Aiwa | 1024, 1026, 1027, 1069 | | | | | | |
| Akai | 1021, 1027 | | | | | | |
| Akiba | 1008, 1029 | | | | | | |
| Akura | 1008, 1027, 1029 | | | | | | |
| Alba | 1008, 1009, 1024, 1025, 1029, 1030 | | | | | | |
| Alienware | 1016 | | | | | | |
| Ambassador | 1030 | | | | | | |
| American High | 1068 | | | | | | |
| Amstrad | 1008, 1009, 1026 | | | | | | |
| Anitech | 1008, 1029 | | | | | | |
| Apex | 1088 | | | | | | |
| ASA | 1028, 1031 | | | | | | |
| Asha | 1070 | | | | | | |
| Asuka | 1008, 1026, 1028, 1029, 1031 | | | | | | |
| Audio Dynamics | 1064 | | | | | | |
| Audiosonic | 1009 | | | | | | |
| Audiovox | 1071 | | | | | | |
| Baird | 1009, 1025, 1026, 1027 | | | | | | |
| Bang & Olufsen | 1017 | | | | | | |
| Basic Line | 1008, 1009, 1024, 1025, 1029, 1030 | | | | | | |
| Baur | 1028 | | | | | | |
| Beaumarck | 1070 | | | | | | |
| Bell & Howell | 1065 | | | | | | |
| Bestar | 1009, 1025, 1030 | | | | | | |
| Black Panther Line | 1009, 1025 | | | | | | |
| Blaupunkt | 1028 | | | | | | |
| Bondstec | 1008, 1030 | | | | | | |
| Broksonic | 1100 | | | | | | |
| Bush | 1008, 1009, 1024, 1025, 1029, 1049, 1051, 1063, 1217 | | | | | | |
| Calix | 1071 | | | | | | |
| Candle | 1070, 1071 | | | | | | |
| Canon | 1068 | | | | | | |
| Cathay | 1009 | | | | | | |
| Catron | 1030 | | | | | | |
| CGE | 1026, 1027 | | | | | | |
| Cimline | 1008, 1024, 1029 | | | | | | |
| CineVision | 1104 | | | | | | |
| Citizen | 1070, 1071 | | | | | | |
| Clatronic | 1008, 1030 | | | | | | |
| Colortyme | 1064 | | | | | | |
| Condor | 1009, 1025, 1030 | | | | | | |
| Craig | 1070, 1071 | | | | | | |
| Crown | 1008, 1009, 1025, 1029, 1030 | | | | | | |
| Curtis Mathes | 1064, 1068, 1070 | | | | | | |
| Cybernex | 1070 | | | | | | |
| CyberPower | 1016 | | | | | | |
| Daewoo | 1009, 1025, 1030, 1038, 1069, 1223 | | | | | | |
| Dansai | 1008, 1009, 1029 | | | | | | |
| Dantax | 1024 | | | | | | |
| Daytron | 1009, 1025 | | | | | | |
| DBX | 1064 | | | | | | |
| De Graaf | 1028 | | | | | | |
| Decca | 1026, 1027, 1028 | | | | | | |
| Dell | 1016 | | | | | | |
| Denko | 1008 | | | | | | |
| DiamondVision | 1096 | | | | | | |
| DigiFusion | 1014 | | | | | | |

| | | | | | | | |
|-------------------|-------------------|-----------------------|-------------------|----------------------|-------------------|--------------|-------------------|
| Sinudyne | 1028 | Accurian | 2142 | Dual | 2380 | LG | 2002, 2033, 2038, |
| Solavox | 1030 | Advent | 2155, 2251 | Durabrand | 2136 | | 2057, 2129, 2133, |
| Sonic Blue | 1022, 1123 | AEG | 2362 | DVX | 2355 | | 2189, 2191, 2223, |
| Sonneclair | 1008 | Airis | 2364 | Easy Home | 2359 | | 2238, 2270, 2288, |
| Sonoko | 1009, 1025 | Aiwa | 2322 | Eclipse | 2354 | | 2335, 2373, 2375 |
| Sontec | 1031 | Akai | 2145, 2177, 2179, | E-Dem | 2364 | Life | 2182 |
| Sony | 1001, 1016, 1048, | | 2248 | Electrohome | 2362 | Lifetec | 2182 |
| | 1053, 1073, 1074, | Akura | 2356 | Elin | 2362 | Limit | 2355 |
| | 1080, 1081, 1082, | Alba | 2064, 2165, 2186, | Elta | 2341, 2361, 2362 | Liquid Video | 2158 |
| | 1083, 1108, 1118, | | 2337, 2346 | Emerson | 2129, 2137, 2150 | Liteon | 2043, 2051, 2142 |
| | 1216 | Alco | 2149 | Enterprise | 2129 | Loewe | 2320 |
| Stack | 1016 | Alize | 2361 | Enzer | 2380 | LogicLab | 2355 |
| Stack 9 | 1016 | Allegro | 2133 | Epson | 2247 | Magnavox | 2025, 2050, 2137, |
| Standard | 1009, 1025 | Amitech | 2362 | ESA | 2137 | | 2150, 2159, 2224, |
| Stern | 1009 | Amphion MediaWorks | 2195 | Finlux | 2354, 2362, 2367 | | 2230, 2358 |
| STS | 1068 | | | Fintec | 2377 | Magnex | 2367 |
| Sunkai | 1024 | AMW | 2195, 2363 | Fisher | 2134 | Majestic | 2360 |
| Sunstar | 1026 | Apex | 2030, 2124, 2125, | Funai | 2137 | Marantz | 2328 |
| Suntronic | 1026 | | 2126, 2127, 2130, | Gateway | 2051 | Marquant | 2362 |
| Sunwood | 1008, 1029 | | 2131 | GE | 2029, 2131, 2156 | Matsui | 2148, 2378 |
| Superscan | 1020 | Apple | 2241 | Gericom | 2351 | McIntosh | 2199 |
| Sylvania | 1020, 1068, 1069, | Arrgo | 2138 | GFM | 2226 | Mecotek | 2362 |
| | 1102, 1126 | Asono | 2364 | Giec | 2382 | Medion | 2182 |
| Symphonic | 1008, 1069, 1126 | Aspire | 2152, 2222 | Global Solutions | 2355 | Memorex | 2028, 2145, 2234 |
| Systemax | 1016 | Astar | 2240 | Global Sphere | 2355 | MiCO | 2354, 2382 |
| Tagar Systems | 1016 | ATACOM | 2364 | Go Video | 2133, 2213 | Micromaxx | 2182 |
| Taisho | 1024 | Audiovox | 2061, 2149 | Goodmans | 2165, 2280, 2291, | Microsoft | 2156 |
| Tandberg | 1009 | Avious | 2367 | | 2358, 2371, 2376, | Microstar | 2182 |
| Tandy | 1065 | Awa | 2363 | | 2382 | Minoka | 2362 |
| Tashiko | 1026, 1071 | Axion | 2249 | GPX | 2227 | Minowa | 2367 |
| Tatung | 1026, 1027, 1028 | Bang & Olufsen | 2128 | Gradiente | 2151 | Mintek | 2131, 2245 |
| TCM | 1015, 1024, 1042 | Baze | 2367 | Graetz | 2380 | Mitsubishi | 2003 |
| Teac | 1009, 1069 | BBK | 2364 | Greenhill | 2131 | Mizuda | 2358, 2359 |
| Tec | 1008, 1009, 1030 | Bellagio | 2363 | Grundig | 2349 | Monyka | 2380 |
| Technics | 1068 | Best Buy | 2359 | Grunkel | 2362, 2366 | Mustek | 2186 |
| Teknika | 1068, 1069, 1071 | Blaupunkt | 2131 | GVG | 2377 | Mx Onda | 2354 |
| Teleavia | 1027 | Blue Parade | 2157 | H&B | 2358 | Mystral | 2366 |
| Telefunken | 1027 | Boghe | 2382 | H.her | 2364 | Naiko | 2362 |
| Teletex | 1008, 1009 | Brainwave | 2362 | Haaz | 2354, 2355 | Nesa | 2131 |
| Tenosal | 1008, 1029 | Brandt | 2148, 2188 | Haier | 2254 | Neufunk | 2380 |
| Tensai | 1008, 1026, 1029, | Broksonic | 2145, 2146 | Harman/Kardon | 2047, 2135 | Nevir | 2362 |
| | 1031 | Bush | 2064, 2110, 2170, | HiMAX | 2359 | Next Base | 2143 |
| | 1024 | | 2268, 2290, 2346, | Hitachi | 2062, 2090, 2115, | Nexstech | 2243 |
| Tevion | 1005, 1027 | | 2358, 2367, 2383 | | 2274, 2282, 2316, | NU-TEC | 2383 |
| Thomson | 1027 | California Audio Labs | 2151 | | 2359, 2380 | Onkyo | 2159, 2368 |
| Thorn | 1027 | | | Hiteker | 2130 | Oopla | 2051 |
| Tivo | 1108, 1110, 1111, | Cambridge Audio | 2354 | Home Tech Industries | 2364 | Oppo | 2196, 2255 |
| | 1113, 1117, 1118, | CAT | 2352, 2353 | | 2366 | Optim | 2381 |
| | 1119, 1122 | CAVS | 2192 | Hyundai | 2366 | Optimus | 2180 |
| TMK | 1070 | Centrum | 2353 | Ilo | 2245 | Orava | 2358 |
| Tokai | 1008, 1029, 1031 | CGV | 2354, 2362 | Initial | 2131, 2245 | Orbit | 2363 |
| Tonsai | 1029 | Changhong | 2140 | Innovation | 2182 | Orion | 2073, 2110 |
| Toshiba | 1004, 1016, 1027, | Cinetec | 2363 | Insignia | 2002, 2137, 2253 | Oritron | 2148, 2158 |
| | 1028, 1037, 1049, | CineVision | 2133, 2237 | Integra | 2157 | P&B | 2358 |
| | 1052, 1086, 1087, | Clatronic | 2358, 2367 | Irradio | 2053 | Pacific | 2355 |
| | 1097, 1109, 1112, | Coby | 2031, 2046, 2360 | iSymphony | 2246 | Panasonic | 2011, 2024, 2034, |
| | 1194 | Conia | 2383 | JBL | 2135 | | 2042, 2058, 2062, |
| Totevision | 1070, 1071 | Continental Edison | 2363 | JVC | 2020, 2096, 2097, | | 2066, 2067, 2093, |
| Touch | 1016 | | 2362 | | 2099, 2100, 2101, | | 2116, 2117, 2118, |
| Towada | 1008, 1029 | Crown | 2362 | | 2102, 2103, 2106, | | 2119, 2120, 2121, |
| Towika | 1008, 1029 | C-Tech | 2355 | | 2107, 2160, 2257, | | 2122, 2123, 2151, |
| TVA | 1030 | Curtis Mathes | 2139 | | 2260, 2262, 2263, | | 2159, 2164, 2166, |
| Uher | 1031 | CVG | 2377 | | 2321, 2324, 2326, | | 2167, 2172, 2173, |
| UltimateTV | 1019 | CyberHome | 2022, 2098, 2138, | | 2327, 2343, 2464, | | 2175, 2209, 2214, |
| Ultravox | 1009 | | 2187, 2336 | | 2465, 2468, 2469, | | 2275, 2277, 2278, |
| Unitech | 1070 | Cytron | 2244 | | 2471 | | 2281, 2282, 2283, |
| United Quick Star | 1009, 1025 | Daenyx | 2363 | Jwin | 2198 | | 2301, 2374, 2470 |
| Universum | 1026, 1028, 1031 | Daewoo | 2001, 2133, 2276, | Kansai | 2360 | Parasound | 2197 |
| Vector Research | 1064 | | 2298, 2330, 2362, | Kawasaki | 2149 | peeKTON | 2364 |
| Video Concepts | 1064 | | 2363, 2377 | Kennex | 2362 | Philips | 2008, 2012, 2025, |
| Videon | 1024 | Daewoo International | 2363 | Kenwood | 2041, 2151, 2348 | | 2044, 2050, 2051, |
| Videosonic | 1070 | | 2363 | KeyPlug | 2362 | | 2053, 2060, 2072, |
| Viewsonic | 1016 | Dalton | 2357 | Kiiro | 2362 | | 2108, 2111, 2147, |
| Voodoo | 1016 | Dansai | 2362, 2381 | Kingavon | 2358 | | 2159, 2163, 2169, |
| Wards | 1068, 1069, 1070, | Daytek | 2184, 2195, 2363 | Kiss | 2380 | | 2174, 2181, 2185, |
| | 1071 | Dayton | 2363 | KLH | 2131, 2149 | | 2230, 2261, 2266, |
| Weltblick | 1031 | DEC | 2358 | Koda | 2358 | | 2267, 2286, 2287, |
| XR-1000 | 1068, 1069 | Decca | 2362 | Koss | 2013, 2148, 2158 | | 2289, 2295, 2300, |
| Yamaha | 1064, 1065 | Denon | 2059, 2151, 2193, | KXD | 2359 | | 2302, 2317, 2328, |
| Yamishi | 1008, 1029 | | 2332 | Landel | 2143 | | 2338, 2342, 2350, |
| Yokan | 1008, 1029 | Denver | 2356, 2358, 2360, | Lasonic | 2132 | | 2467 |
| Yoko | 1008, 1029, 1030, | | 2370 | Lawson | 2355 | Phonotrend | 2367 |
| | 1031 | Denzel | 2380 | Lecson | 2381 | Pioneer | 2016, 2017, 2018, |
| Zenith | 1114 | Desay | 2205 | Lenco | 2358, 2362, 2367 | | 2019, 2035, 2092, |
| ZT Group | 1016 | Diamond | 2354, 2355 | Lenoxx | 2136, 2153 | | 2094, 2095, 2109, |
| | | DiamondVision | 2225, 2232 | | | | 2157, 2180, 2190, |
| | | Disney | 2010, 2028 | | | | 2212, 2269, 2272, |
| | | DK Digital | 2339 | | | | 2299, 2304, 2305, |
| | | Dmtech | 2176 | | | | 2306, 2307, 2308, |

DVD

4Kus 2051

| | | | | | | | |
|--------------------|-------------------|-------------------|-------------------|------------------------|-------------------|------------------|-------------------|
| Signature | 3066 | BT | 4216 | Flair Mate | 4217 | Lifesat | 4008, 4024, 4212, |
| Sony | 3092, 3125 | Bubu Sat | 4217 | Foxtel | 4222 | | 4217 |
| Sprucer | 3118 | Bush | 4006, 4045 | Freecom | 4001, 4049, 4218 | Lifetec | 4008 |
| Standard Component | | Cambridge | 4218 | FTEmaximal | 4024, 4217 | Lorenzen | 4219 |
| | 3115 | Canal Satellite | 4213 | Fuba | 4001, 4008, 4014, | Lorraine | 4049 |
| Starcom | 3017, 3072, 3119, | Canal+ | 4213 | | 4015, 4024, 4055, | Lupus | 4008, 4024 |
| | 3123 | CaptiveWorks | 4099 | | 4215 | Luxor | 4218 |
| Stargate | 3072, 3123 | Channel Master | 4007, 4110 | Galaxis | 4005, 4008, 4009, | Lyonnaise | 4052 |
| Starquest | 3072, 3123 | Chaparral | 4075 | | 4024, 4048, 4050, | Macab | 4052 |
| Supercable | 3090 | CHEROKEE | 4216 | | 4215, 4222 | Magnavox | 4101, 4127 |
| Supermax | 3127 | Chess | 4212, 4217 | GE | 4066, 4093, 4111, | Manata | 4031, 4216, 4217 |
| Tele+1 | 3107, 3111 | CityCom | 4006, 4215, 4219 | | 4197 | Manhattan | 4006, 4010, 4048, |
| Telepiu | 3107 | Clatronic | 4013 | General Instrument | | | 4216 |
| Thomson | 3082, 3091 | CNT | 4010 | | 4019, 4073 | Marantz | 4055 |
| TIME WARNER | 3084 | Comag | 4080, 4081, 4082, | GMI | 4011 | Mascom | 4010 |
| Tocom | 3067 | | 4083, 4086 | GOI | 4117 | Maspro | 4006, 4217 |
| Torx | 3017 | Commlink | 4005 | Goldbox | 4213 | Matsui | 4216 |
| Toshiba | 3122 | Comtech | 4050 | GoldStar | 4049 | Max | 4219 |
| Tristar | 3127 | Condor | 4008, 4024, 4219 | Goodmans | 4002, 4006, 4029 | Mediabox | 4213 |
| Tudi | 3102 | Connexions | 4014, 4024 | Goodmind | 4111 | Mediamarkt | 4011 |
| Tusa | 3072, 3123 | Conrad | 4024, 4215, 4218, | Grandin | 4031 | Mediasat | 4009, 4213, 4218 |
| TV86 | 3077 | | 4219 | Grothusen | 4001, 4049 | Medion | 4008, 4024, 4217 |
| Unika | 3065, 3070 | Conrad Electronic | 4217, 4219 | Grundig | 4004, 4006, 4015, | Medison | 4217 |
| United Cable | 3018, 3119 | Contec | 4050 | | 4035, 4211, 4218, | Mega | 4053, 4055 |
| Universal | 3065, 3070 | Coolsat | 4096 | | 4222 | Memorex | 4127 |
| Universum | 3097, 3099 | Cosat | 4048 | Hänsel & Gretel | 4219 | Metronic | 4001, 4004, 4005, |
| V2 | 3127 | Coship | 4109 | Hantor | 4001, 4013 | | 4010, 4028, 4031, |
| Videoway | 3019 | Crown | 4011 | Hanuri | 4010 | | 4217 |
| View Star | 3074, 3077, 3079 | Daeryung | 4014 | Hauppauge | 4044 | Metz | 4015 |
| Viewmaster | 3127 | Daewoo | 4057, 4217 | Heliocom | 4219 | Micro electronic | 4217, 4218, 4219 |
| Vision | 3127 | DDC | 4007 | Helium | 4219 | Micro Technology | 4217 |
| Visiopass | 3097, 3100, 3101 | Delega | 4007 | Hinari | 4007 | MicroGem | 4106 |
| Vortex View | 3127 | Dew | 4050 | Hirschmann | 4015, 4024, 4210, | Micromaxx | 4008, 4024 |
| Wittenberg | 3098 | Diamond | 4051 | | 4216, 4218, 4219 | Microstar | 4008 |
| Zenith | 3113, 3122, 3124 | Digiality | 4219 | Hisawa | 4013 | Microtec | 4217 |
| Zentek | 3126 | Digital Stream | 4105 | Hisense | 4016 | Minerva | 4015 |
| Verizon Fios | 3007 | DIRECTV | 4056, 4064, 4067, | Hitachi | 4006, 4114, 4199, | Mitsubishi | 4006, 4015, 4202 |
| | | | 4068, 4070, 4071, | | 4203 | Mitsumi | 4054 |
| | | | 4074, 4107, 4116, | Homecast | 4084, 4085, 4087 | Morgan's | 4011, 4053, 4054, |
| | | | 4119, 4121, 4122, | Houston | 4048 | | 4055, 4217 |
| | | | 4123, 4127, 4192, | HTS | 4117 | Motorola | 4019, 4088, 4090, |
| | | | 4193, 4194, 4195, | Hughes | 4064, 4068, 4192, | | 4091 |
| | | | 4196, 4197, 4198, | | 4194, 4196, 4202 | Multichoice | 4222 |
| | | | 4199, 4200, 4201, | Hughes Network Systems | | Multitec | 4212 |
| | | | 4202, 4203, 4206, | | 4071 | Muratto | 4049 |
| | | | 4207, 4221 | Humax | 4025, 4030, 4060, | Mysat | 4217 |
| | | Discoverer | 4212 | | 4097 | Navex | 4013 |
| | | Discovery | 4216 | Huth | 4005, 4011, 4012, | Neuhaus | 4009, 4048, 4217, |
| | | Diseqc | 4216 | | 4013, 4048, 4050, | | 4218, 4219 |
| | | Dish Network | 4018, 4065, 4089, | | 4219, 4223 | Neusat | 4217 |
| | | | 4092, 4094, 4095, | Hypson | 4031 | Next Level | 4019 |
| | | | 4117 | Ilo | 4016 | NextWave | 4223 |
| | | Dishpro | 4018, 4117 | Imex | 4031 | Nikko | 4011, 4217 |
| | | Distrisat | 4053 | Innovation | 4008 | Nokia | 4006, 4040 |
| | | Ditristrad | 4048 | Insignia | 4107 | Nordmende | 4001, 4006, 4007, |
| | | DNT | 4014, 4053, 4055 | Intertronic | 4011 | | 4010, 4052 |
| | | Drake | 4072 | Intervision | 4048, 4219 | Nova | 4222 |
| | | DStv | 4222 | ITT Nokia | 4006 | Novis | 4013 |
| | | Dune | 4024 | Jerold | 4019 | Oceanic | 4051 |
| | | Echostar | 4014, 4018, 4065, | Johansson | 4013 | Octagon | 4001, 4004, 4050 |
| | | | 4089, 4117, 4217 | JOK | 4216 | Okano | 4011 |
| | | Einhell | 4001, 4005, 4011, | JSR | 4048 | Optex | 4048 |
| | | | 4217, 4218 | JVC | 4029, 4065, 4089, | Optus | 4213, 4222, 4223 |
| | | | 4216, 4217 | | 4117 | Orbitech | 4001, 4212, 4213, |
| | | Elap | 4010 | Kamm | 4217 | | 4218 |
| | | Elekta | 4010 | Kathrein | 4015, 4034, 4042, | OSat | 4004 |
| | | Elsat | 4217 | | 4053, 4055, 4063, | Otto Versand | 4015 |
| | | Elta | 4001, 4008, 4024, | | 4215, 4216, 4217 | Pace | 4006, 4015, 4035, |
| | | | 4048, 4053, 4055 | Kathrein Eurostar | 4215 | | 4043, 4047, 4216 |
| | | Emanon | 4001 | Klap | 4216 | Pacific | 4051 |
| | | Emme Esse | 4008, 4024 | Konig | 4219 | Packsat | 4216 |
| | | Engel | 4217 | Kosmos | 4049 | Palcom | 4007 |
| | | Ep Sat | 4006 | KR | 4004 | Palladium | 4011, 4218 |
| | | EURIEULT | 4031 | Kreiselmeier | 4015 | Palsat | 4212, 4218 |
| | | Eurodec | 4052 | K-SAT | 4217 | Panasat | 4222 |
| | | Europa | 4053, 4218, 4219 | Kyostar | 4001 | Panasonic | 4006, 4035, 4036, |
| | | Europhon | 4219 | L&S Electronic | 4024 | | 4121, 4124, 4126, |
| | | Eurosat | 4011 | Lasat | 4008, 4010, 4024, | | 4198, 4221 |
| | | Eurosky | 4008, 4011, 4024, | | 4054, 4212, 4215, | Panda | 4006, 4219 |
| | | | 4011, 4215, 4219 | Lasonic | 4108 | Pansat | 4125 |
| | | Eurostar | 4011, 4215, 4219 | Lenco | 4001, 4024, 4049, | Patriot | 4216 |
| | | Eutelsat | 4217 | | 4215, 4217, 4219 | Paysat | 4127 |
| | | Exator | 4001, 4004 | Leng | 4013 | PCT | 4110 |
| | | Expressvu | 4117 | Lennox | 4048 | Philco | 4101 |
| | | Fenner | 4024, 4212, 4217 | Lenson | 4218 | Philips | 4006, 4033, 4053, |
| | | Ferguson | 4006, 4052, 4214 | Lexus | 4053 | | 4055, 4061, 4068, |
| | | Fidelity | 4218 | LG | 4049, 4103, 4107 | | 4071, 4127, 4196, |
| | | Finlandia | 4006 | | | | 4201, 4202, 4203, |
| | | Finlux | 4006 | | | | 4206, 4213, 4216 |
| | | FinnSat | 4050, 4052 | | | | |

Satellite

| | |
|---------------|-------------------|
| AB Sat | 4216, 4217 |
| AccessHD | 4104 |
| ADB | 4220 |
| AGS | 4216 |
| Akai | 4053, 4055 |
| Alba | 4001, 4004, 4006, |
| | 4007, 4062, 4217 |
| Aldes | 4005, 4007, 4010 |
| Allsat | 4048, 4053, 4055 |
| Allsonic | 4005, 4008, 4024 |
| Alltech | 4217 |
| Alpha | 4053 |
| Alpha Digital | 4104 |
| Alphastar | 4077 |
| Amitronica | 4217 |
| Amstrad | 4011, 4035, 4217, |
| | 4218 |
| Anglo | 4217 |
| Ankaro | 4005, 4008, 4024, |
| | 4217 |
| Anttron | 4001, 4004 |
| Apollo | 4001 |
| Armstrong | 4011, 4053 |
| Artec | 4100 |
| Asat | 4053, 4055 |
| ASLF | 4217 |
| Astacom | 4216 |
| Astra | 4009, 4011, 4054, |
| | 4217, 4219 |
| Astro | 4004, 4008, 4010, |
| | 4015, 4024, 4213, |
| | 4218, 4219 |
| AudioTon | 4004, 4048 |
| Aurora | 4222 |
| Austar | 4222 |
| Axial | 4216 |
| Axis | 4008, 4009, 4024, |
| | 4050 |
| Best | 4008, 4024 |
| Blaupunkt | 4015 |
| Blue Sky | 4217 |
| Boca | 4011, 4054, 4059, |
| | 4217 |
| Boston | 4216 |
| Brain Wave | 4013 |
| Broadcast | 4012 |
| Broco | 4217 |
| BSkyB | 4035, 4041 |

| | | | | | | | |
|-------------|--|---------------|--|------------|--|---------|------------------------------|
| Phoenix | 4050 | Schneider | 4008, 4212, 4216 | Teleka | 4004, 4011, 4014, 4218, 4219 | Zehnder | 4008, 4010, 4024, 4209, 4215 |
| Phonotrend | 4005, 4006, 4048 | Schwaiger | 4051, 4212, 4219 | Telemaster | 4010 | Zenith | 4102, 4107, 4195 |
| Pioneer | 4046, 4213 | SCS | 4215 | Telesat | 4219 | Zodiac | 4004 |
| Polsat | 4052 | Seemann | 4009, 4011, 4014 | Telestar | 4212, 4213, 4218 | | |
| Predki | 4013 | SEG | 4001, 4008, 4013, 4024 | Televés | 4006, 4218 | | |
| Premiere | 4048, 4213 | | | Telewire | 4048 | | |
| Priesner | 4011 | Seleco | 4048 | Tempo | 4223 | | |
| Primestar | 4076 | Servi Sat | 4031, 4217 | Tevion | 4008, 4217 | | |
| Profile | 4216 | Siemens | 4015 | Thomson | 4006, 4020, 4052, 4058, 4208, 4213, 4215, 4216, 4217, 4219 | | |
| Promax | 4006 | Silva | 4049 | | | | |
| Prosat | 4005, 4007 | Skantin | 4217 | Thorens | 4051 | | |
| Proscan | 4066, 4093, 4122, 4197 | Skardin | 4009 | Thorn | 4006 | | |
| | | Skinsat | 4218 | Tivax | 4104 | | |
| Protek | 4051 | SKR | 4217 | Tivo | 4196 | | |
| Proton | 4016 | Skymaster | 4005, 4017, 4022, 4212, 4217 | Tokai | 4053 | | |
| Provision | 4010 | | | Tonna | 4006, 4012, 4048, 4217, 4218 | | |
| Quadral | 4005, 4007, 4008, 4024, 4216 | Skymax | 4053, 4055 | Toshiba | 4194, 4202, 4203 | | |
| | | SkySat | 4212, 4217, 4218, 4219 | Triad | 4049 | | |
| Quelle | 4015, 4215, 4219 | | | Triasat | 4218 | | |
| Quiero | 4052 | Skyvision | 4048 | Triax | 4015, 4215, 4217, 4218 | | |
| RadioShack | 4019 | SM Electronic | 4212, 4217 | Turnsat | 4217 | | |
| Radiola | 4053, 4055 | Smart | 4215, 4217 | Tvonic | 4214 | | |
| Radix | 4014, 4037 | Sony | 4067, 4070, 4213 | Twiner | 4031, 4217 | | |
| Rainbow | 4004 | SR | 4011, 4054 | UEC | 4222 | | |
| RCA | 4066, 4093, 4112, 4113, 4116, 4118, 4119, 4122, 4197, 4207 | Star Choice | 4019 | Uher | 4212 | | |
| | | Starland | 4217 | UltimateTV | 4070 | | |
| Realistic | 4078 | Starring | 4013 | Uniden | 4079, 4127 | | |
| Redpoint | 4009 | Start Trak | 4001 | Unisat | 4011, 4050, 4053 | | |
| Redstar | 4008, 4024 | Strong | 4001, 4004, 4008, 4024, 4049, 4222 | Unitor | 4013 | | |
| RFT | 4005, 4053, 4055 | | | Universum | 4015, 4215, 4219 | | |
| Roadstar | 4217 | STS | 4115 | US Digital | 4016 | | |
| Roch | 4031 | STVI | 4031 | Variosat | 4015 | | |
| Rover | 4024, 4217 | Sumida | 4011 | Vega | 4024 | | |
| Saba | 4010, 4215, 4216, 4219 | Sunny Sound | 4024 | Ventana | 4053, 4055 | | |
| | | Sunsat | 4217 | Viewsat | 4098 | | |
| Sabre | 4006 | Sunstar | 4011, 4024, 4054 | Visiosat | 4013, 4048, 4216, 4217 | | |
| Sagem | 4023, 4052 | Supermax | 4223 | | | | |
| Sakura | 4050 | Tandberg | 4052 | Voom | 4019 | | |
| Samsung | 4000, 4001, 4003, 4032, 4064, 4069, 4071, 4120, 4123, 4196, 4200 | Tandy | 4004 | Vortec | 4001 | | |
| | | Tantec | 4006 | Welltech | 4212 | | |
| SAT | 4007, 4218 | TCM | 4008 | WeTeKom | 4212, 4218 | | |
| Sat Cruiser | 4223 | Techniland | 4012 | Wevasat | 4006 | | |
| Sat Partner | 4001, 4004, 4010, 4013, 4049, 4218 | TechniSat | 4014, 4021, 4026, 4027, 4038, 4039, 4053, 4212, 4213, 4218 | Wewa | 4006 | | |
| | | | | Winersat | 4013 | | |
| Sat Team | 4217 | Technology | 4222 | Wisi | 4006, 4014, 4015, 4218, 4219 | | |
| Satcom | 4012, 4219 | Technosat | 4223 | | | | |
| Satec | 4217 | Technowelt | 4219 | Woorisat | 4010 | | |
| Satelco | 4024 | Teco | 4011, 4054 | Worldsat | 4216 | | |
| Satford | 4012 | Telanon | 4007 | Xrypton | 4024 | | |
| Satmaster | 4012 | Telasat | 4215, 4219 | XSat | 4217 | | |
| Satplus | 4212 | Telecom | 4217 | | | | |
| | | Telefunken | 4001, 4017, 4216 | | | | |

CD

Yamaha 5082, 5095

CD Recorder

Yamaha 5083

MD

Yamaha 5080, 5081, 5086

Tape

Yamaha 5084, 5087

Tuner

Yamaha 5066, 5071, 5085, 5088, 5090, 5092, 5094

XM

Yamaha 5091, 5093

SIRIUS

Yamaha 5064, 5067

DOCK

Yamaha 5068, 5089

NET

Yamaha 5076, 5079

LD

Yamaha 2080

Amplifier

Yamaha 5019, 5020