



AB

YSP-500

Digital Sound Projector™

OWNER'S MANUAL

Caution: Read this before operating this unit.

- 1 To assure the finest performance, please read this manual carefully. Keep it in a safe place for future reference.
- 2 Install this sound system in a well ventilated, cool, dry, clean place with at least 5 cm (2 in) of space above (or below) this unit – away from direct sunlight, heat sources, vibration, dust, moisture, and/or cold.
- 3 Locate this unit away from other electrical appliances, motors, or transformers to avoid humming sounds.
- 4 Do not expose this unit to sudden temperature changes from cold to hot, and do not locate this unit in an environment with high humidity (i.e. a room with a humidifier) to prevent condensation inside this unit, which may cause an electrical shock, fire, damage to this unit, and/or personal injury.
- 5 Avoid installing this unit where foreign object may fall onto this unit and/or this unit may be exposed to liquid dripping or splashing. On the top of this unit, do not place:
 - Other components, as they may cause damage and/or discoloration on the surface of this unit.
 - Burning objects (i.e. candles), as they may cause fire, damage to this unit, and/or personal injury.
 - Containers with liquid in them, as they may fall and liquid may cause electrical shock to the user and/or damage to this unit.
- 6 Do not cover this unit with a newspaper, tablecloth, curtain, etc. in order not to obstruct heat radiation. If the temperature inside this unit rises, it may cause fire, damage to this unit, and/or personal injury.
- 7 Do not plug in this unit to a wall outlet until all connections are complete.
- 8 Do not operate this unit upside-down. It may overheat, possibly causing damage.
- 9 Do not use force on switches, knobs and/or cords.
- 10 When disconnecting the power supply cable from the wall outlet, grasp the plug; do not pull the cable.
- 11 Do not clean this unit with chemical solvents; this might damage the finish. Use a clean, dry cloth.
- 12 Only voltage specified on this unit must be used. Using this unit with a higher voltage than specified is dangerous and may cause fire, damage to this unit, and/or personal injury. Yamaha will not be held responsible for any damage resulting from use of this unit with a voltage other than specified.
- 13 To prevent damage by lightning, keep the power supply cable disconnected from a wall outlet or this unit during a lightning storm.
- 14 Do not attempt to modify or fix this unit. Contact qualified Yamaha service personnel when any service is needed. The cabinet should never be opened for any reasons.
- 15 When not planning to use this unit for long periods of time (i.e. vacation), disconnect the power supply cable from the wall outlet.
- 16 Be sure to read the “Troubleshooting” section on common operating errors before concluding that this unit is faulty.
- 17 Before moving this unit, press STANDBY/ON to set this unit in standby mode, and disconnect the power supply cable from the wall outlet.
- 18 Condensation will form when the surrounding temperature changes suddenly. Disconnect the power supply cable from the outlet, then leave the unit alone.
- 19 When using the unit for a long time, the unit may become warm. Turn the power off, then leave the unit alone for cooling.
- 20 Install this unit near the AC outlet and where the AC power plug can be reached easily.

- 21 The batteries shall not be exposed to excessive heat such as sunshine, fire or the like.

WARNING

TO REDUCE THE RISK OF FIRE OR ELECTRIC SHOCK, DO NOT EXPOSE THIS UNIT TO RAIN OR MOISTURE.

WARNING

THE POWER SUPPLY CABLE OF THIS UNIT MUST BE CONNECTED TO THE MAIN SOCKET OUTLET VIA A PROTECTIVE EARTHING CONNECTION.

This unit is not disconnected from the AC power source as long as it is connected to the AC wall outlet, even if this unit itself is turned off by STANDBY/ON. This state is called the standby mode. In this state, this unit is designed to consume a very small quantity of power.

FOR U.K. CUSTOMERS

If the socket outlets in the home are not suitable for the plug supplied with this appliance, it should be cut off and an appropriate 3 pin plug fitted. For details, refer to the instructions described below. Note that the plug severed from the mains lead must be destroyed, as a plug with bared flexible cord is hazardous if engaged in a live socket outlet.

IMPORTANT

THE WIRES IN MAINS LEAD ARE COLOURED IN ACCORDANCE WITH THE FOLLOWING CODE:

Blue: NEUTRAL

Brown: LIVE

As the colours of the wires in the mains lead of this apparatus may not correspond with the coloured markings identifying the terminals in your plug, proceed as follows:

The wire which is coloured BLUE must be connected to the terminal which is marked with the letter N or coloured BLACK.

The wire which is coloured BROWN must be connected to the terminal which is marked with the letter L or coloured RED. Make sure that neither core is connected to the earth terminal of the three pin plug.

CAUTION

Danger of explosion if battery is incorrectly replaced. Replace only with the same or equivalent type.

CAUTION

Use of controls or adjustments or performance of procedures other than those specified herein may result in hazardous radiation exposure.



This symbol mark is according to the EU directive 2002/96/EC.

This symbol mark means that electrical and electronic equipment, at their end-of-life, should be disposed of separately from your household waste.

Please act according to your local rules and do not dispose of your old products with your normal household waste.

Contents

INTRODUCTION

Overview	2
Features	3
Using this manual	5
Supplied accessories	6
Controls and functions	7
Front panel	7
Front panel display	8
Rear panel	9
Remote control	10

PREPARATION

Installation	13
Before installing this unit	13
Installing this unit	13
Connections	16
Before connecting components	17
Connecting a TV	18
Connecting a DVD player/recorder	19
Connecting a digital satellite tuner or a cable TV tuner	20
Connecting a digital airwave tuner	21
Connecting a VCR	22
Connecting other external components	23
Connecting a subwoofer	24
Connecting the AC power supply cable	25

SETUP

Getting started	26
Installing batteries in the remote control	26
Operation range of the remote control	26
Turning on this unit or setting it to the standby mode	27
Using SET MENU	28
Displaying the OSD (on-screen display)	28
The flow chart of SET MENU	29
Changing OSD language	30
AUTO SETUP (IntelliBeam)	31
The flow chart of AUTO SETUP	31
Installing the IntelliBeam microphone	32
Using AUTO SETUP (IntelliBeam)	33
Using the system memory	38
Convenient usage of the system memory	38
Saving settings	38
Loading settings	39

BASIC OPERATION

Playback	41
Selecting the input source	41
Playing back sources	42
Adjusting the volume	43
Enjoying surround sound	44
5 Beam	44
Stereo plus 3 Beam	45
3 Beam	45
My Surround	45
Enjoying 2-channel sources in surround sound	47
Enjoying TV in surround sound	48
Adjusting surround mode parameters	49

Enjoying stereo sound	50
Playing back sound clearly (My Beam)	51
Using auto-adjust function	51
Using manual-adjust function	52
Using the volume mode (Night listening enhancer/TV volume equal mode)	53
Using the sleep timer	54

ADVANCED OPERATION

MANUAL SETUP	56
Using MANUAL SETUP	57
BEAM MENU	58
SOUND MENU	62
INPUT MENU	64
DISPLAY MENU	66
Adjusting the audio balance	67
Using the test tone	67
Using the audio output being played back	68
Selecting the input mode	70
Adjusting the system parameters	71
Using the system parameters	71
Setting the MEMORY PROTECT	72
Setting the MAX VOLUME	73
Setting the TURN ON VOLUME	73
Setting the DEMO MODE	74
Setting the PANEL INP. KEY	75
Disabling the front panel keys	76
Setting the FACTORY PRESET	77
Remote control features	79
Setting remote control codes	79
Controlling other components	80
Using the TV macro	83

ADDITIONAL INFORMATION

Troubleshooting	85
Glossary	88
Index	90
Specifications	91

List of remote control codes	i
------------------------------------	---

INTRODUCTION

PREPARATION

SETUP

BASIC
OPERATION

ADVANCED
OPERATION

ADDITIONAL
INFORMATION

English

Overview

It is generally accepted that in order to fully enjoy the benefits of surround sound at home, you must endure the agony of wiring and installing a great number of speakers in the hope that your listening room will give you the same kind of surround sound experience as your local movie theater.

Yamaha YSP-500 Digital Sound Projector challenges this preconception that complicated speaker setup and troublesome wiring go hand-in-hand with the enjoyment of multi-channel surround sound.

This slimline unit does away with the need for complicated wiring and installation worries, leaving you with a unit that is not only easy to set up, but is also capable of reproducing the kind of powerful surround sound you have been waiting for from its built-in 2 woofers and 16 full-range small speakers.

You can fine-tune the parameters of this unit to adjust the delay time for separate sound beams, resulting in highly directional sound that comes in on the listening position from all directions.

The YSP-500 projects sound beams containing surround sound information for the front right (R), front left (L), surround right (SR), and surround left (SL) speaker positions, which are reflected off the walls of your listening room before reaching the actual listening position. With the addition of center (C) sound beams, this Digital Sound Projector creates true-to-life 5.1-channel surround sound that makes you feel as if there are actual speakers around the room.

Sit back and enjoy the real sound experience of this simple, yet stylish Digital Sound Projector.

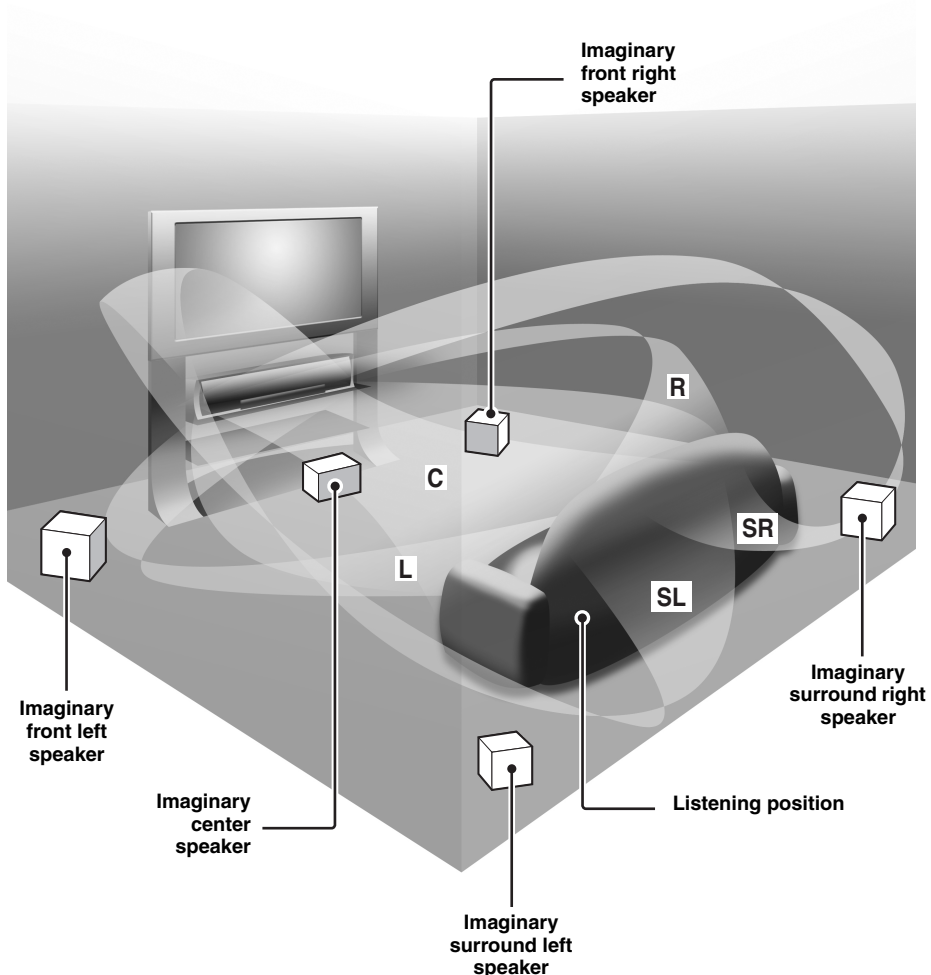

Features

Digital Sound Projector™

The Digital Sound Projector technology allows one slim unit to control and steer multiple channels of sound to generate multi-channel surround sound, thus eliminates the need for satellite loudspeakers and cabling normally associated with conventional surround sound systems. This unit also employs the beam modes that let you enjoy the surround sound (5 Beam, Stereo plus 3 Beam, 3 Beam, and My Surround), stereo playback, and My Beam.

My Surround

In addition to the above mentioned beam modes, this unit is equipped with My Surround beam mode that allows you to enjoy surround system even in a small listening area.

My Beam

This unit employs My Beam that ensures a clear sound in a noisy environment. You can adjust the beam angle manually or automatically using the supplied remote control to the maximum of 30°, rightward and leftward.

Versatile Remote Control

The supplied remote control comes with preset remote control codes used to control the DVD player, VCR, cable TV tuner, and digital satellite tuner connected to this unit. In addition, the remote control is equipped with the macro capability that enables a series of operations with the press of a single button.

AUTO SETUP (IntelliBeam)

This unit employs the automatic sound beam and acoustic optimization technology with the aid of the supplied IntelliBeam microphone. You can avoid troublesome listening-based speaker setup and achieve highly accurate sound beam adjustments that best match your listening environment.

Compatibility with the Newest Technologies

This unit employs decoders compatible with Dolby Digital, DTS, Dolby Pro Logic, Dolby Pro Logic II, and DTS Neo:6.

- ◆ **Dolby Digital**
This is the standard audio signal format used on various digital media such as DVD, Blu-ray, and HD DVD. This surround technology delivers high-quality digital audio for up to 5.1 discrete channels to produce a directional and more realistic effect.
- ◆ **DTS**
This is the standard audio signal format used on various digital media such as DVD, Blu-ray, and HD DVD. This surround technology delivers high-quality digital audio for up to 5.1 discrete channels to produce a directional and more realistic effect.
- ◆ **Dolby Pro Logic**
This sophisticated, matrix decoding technology up-converts any 2-channel source audio to a 5.1-channel full bandwidth playback, resulting in a surround sound experience.
- ◆ **Dolby Pro Logic II**
This is a redesigned version of Dolby Pro Logic that employs 2 stereo surround channels, a subwoofer, and a greatly enhanced steering logic. This improved technology provides an exceptionally stable sound field that simulates 5.1 to a much greater degree than the original Dolby Pro Logic.
- ◆ **DTS Neo:6**
This technology decodes the conventional 2-channel sources for 6-channel playback, enabling playback with the full-range channels with higher separation. Music mode and Cinema mode are available to play back music and movie sources respectively.

IntelliBeam

The “IntelliBeam” logo and “IntelliBeam” are trademarks of YAMAHA Corporation.



Manufactured under license from Dolby Laboratories. “Dolby”, “Pro Logic”, and the double-D symbol are trademarks of Dolby Laboratories.



“DTS” and “Neo:6” are registered trademarks of DTS, Inc.



Manufactured under license from 1 Ltd. Worldwide patents applied for.

The “1” logo and “Digital Sound Projector™” are trademarks of 1 Ltd.



TruBass, SRS and the “●” symbol are registered trademarks of SRS Labs, Inc. TruBass technology is incorporated under license from SRS Labs, Inc.



EUPHONY™ is a trademark of DiMAGIC Co., Ltd.

Using this manual

Notes

- This manual describes how to connect and operate this unit. For details regarding the operation of external components, refer to the supplied owner's manual for each component.
- Operations in this manual use keys on the supplied remote control of this unit unless otherwise specified.
- * indicates a tip for your operation.
- This manual is printed prior to production. Designs and specifications are subject to change in part as a result of improvements, etc. In case of differences between the manual and the product, the product has priority.

1 Install this unit in your listening room.

See "Installation" on page 13.



2 Connect this unit to your TV and other external components.

See "Connections" on page 16.



3 Prepare the remote control and turn on the power of this unit.

See "Getting started" on page 26.



4 Run AUTO SETUP.

See "AUTO SETUP (IntelliBeam)" on page 31.



5 Play back a source.

See "Playback" on page 41.



6 Change the beam modes.

See "Enjoying surround sound" on page 44.



If you want to make additional settings and adjustments

7 Run MANUAL SETUP to fine-tune settings and/or set remote control codes.

See "MANUAL SETUP" on page 56 and "Remote control features" on page 79.

Supplied accessories

Check that you have received all of the following parts.

Remote control (×1)

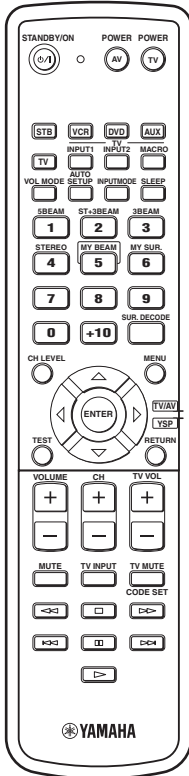

Cable clamp (×1)

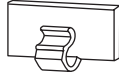

Optical cable (×1)



IntelliBeam microphone (×1)

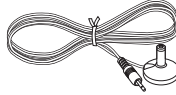

Digital audio pin cable (×1)

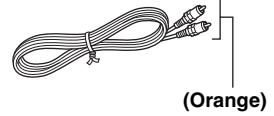

Cardboard microphone stand (×1)

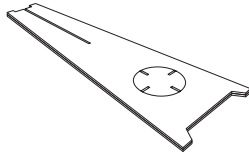

Audio pin cable (×1)

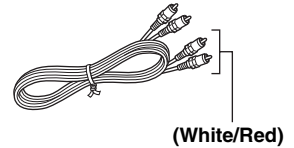

Indoor FM antenna (×1)

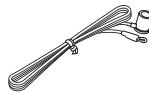

OSD* video pin cable (×1)

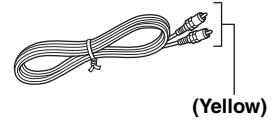

**Batteries (×2)
(AA, R6, UM-3)**

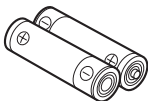

Demonstration DVD (×1)

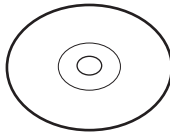

*OSD: On-Screen Display

QUICK REFERENCE GUIDE

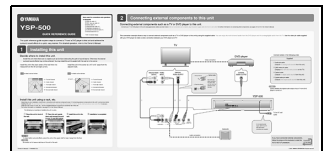

* The number of provided languages varies depending on the model.

Controls and functions

Front panel

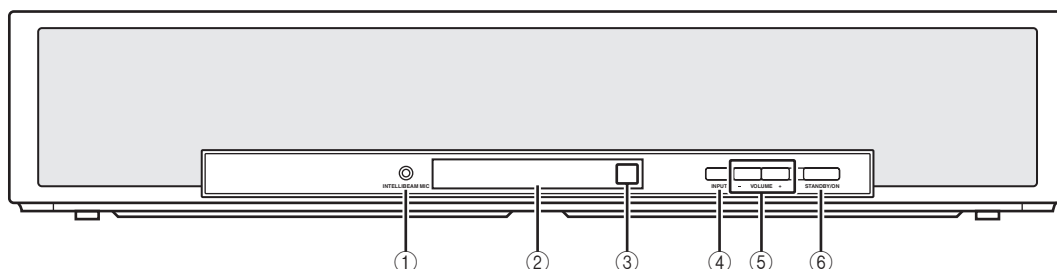

① INTELLIBEAM MIC jack

Connect the supplied IntelliBeam microphone for AUTO SETUP (see page 32).

② Front panel display

Shows information about the operational status of this unit.

③ Remote control sensor

Receives infrared signals from the remote control.

④ INPUT

Press repeatedly to switch between input sources (see page 41).

Outputs a test tone to experience the sound beam (see page 74).

⑤ VOLUME +/-

Controls the volume level of all audio channels (see page 43).

⑥ STANDBY/ON

Turns on the power of this unit or sets it to the standby mode (see page 27).

Notes

- When you turn on this unit, you will hear a click sound followed by the 4 to 5-second interval before sound reproducing.
- In the standby mode, this unit consumes a small amount of power in order to receive infrared signals from the remote control.

Front panel display

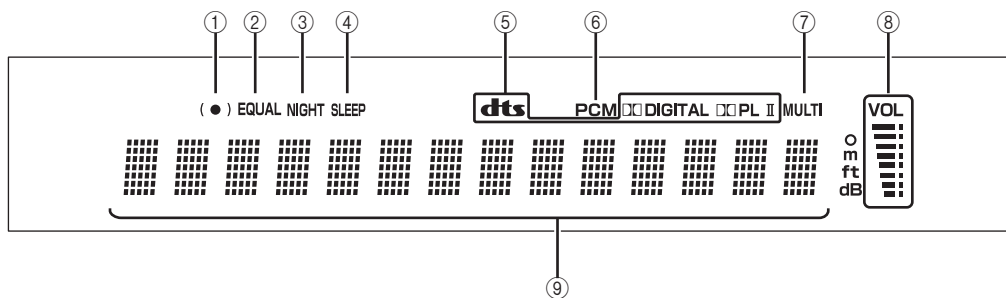

① SRS TruBass indicator

Lights up when TruBass is turned on (see page 63).

② EQUAL indicator

Lights up when the TV volume equal mode is selected (see page 53).

③ NIGHT indicator

Lights up when one of the night listening enhancers is selected (see page 53).

④ SLEEP indicator

Lights up when the sleep timer is set (see page 54).

⑤ Decoder indicators

Light up when the corresponding decoder operates (see page 46).

⑥ PCM indicator

Lights up when this unit is reproducing PCM (Pulse Code Modulation) digital audio signals.

⑦ MULTI indicator

Lights up when this unit detects a multi channel digital audio signal.

⑧ Volume level indicator

Displays the current volume level.

⑨ Multi-information display

Shows information with alphanumeric characters when you adjust the parameters of this unit.



You can adjust the brightness and display setting of the front panel display using the F.DISPLAY SET parameter in MANUAL SETUP (see page 66).

Rear panel

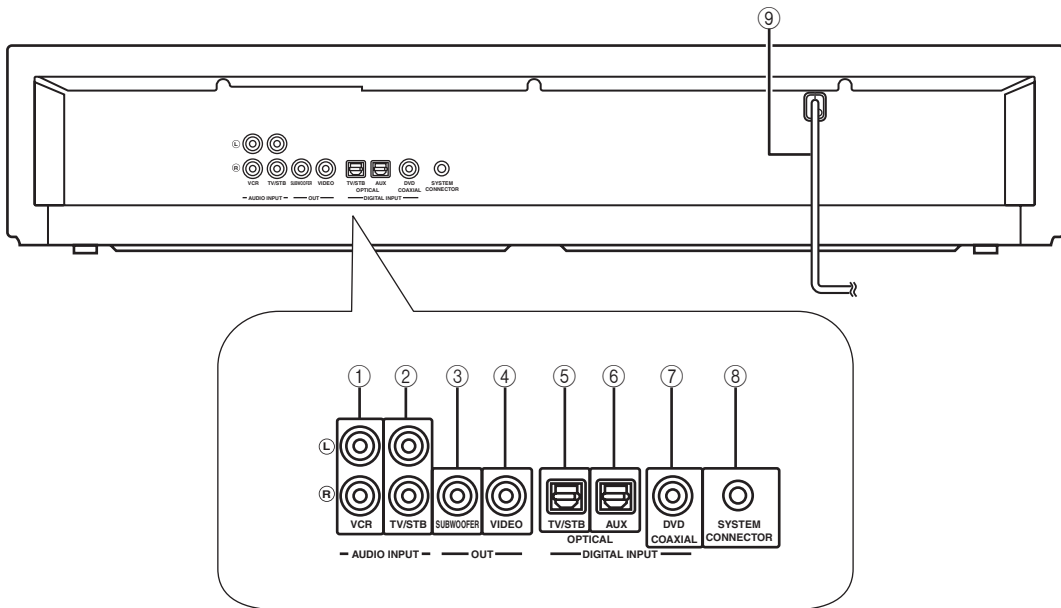

① VCR AUDIO INPUT jacks

Connect your VCR via an analog connection (see page 19).

② TV/STB AUDIO INPUT jacks

Connect your TV, digital satellite tuner, or cable TV tuner via an analog connection (see pages 18 and 20).

③ SUBWOOFER OUT jack

Connect your subwoofer (see page 24).

④ VIDEO OUT jack

Connect to the video input jack of your TV to display the OSD of this unit (see page 18).

⑤ TV/STB OPTICAL DIGITAL INPUT jack

Connect your TV, digital satellite tuner, or cable TV tuner via an optical digital connection (see pages 18 and 20).

⑥ AUX OPTICAL DIGITAL INPUT jack

Connect an external component via an optical digital connection (see page 23).

⑦ DVD COAXIAL DIGITAL INPUT jack

Connect your DVD player via a coaxial digital connection (see page 19).

⑧ SYSTEM CONNECTOR jack

Use to connect a Yamaha subwoofer equipped with a SYSTEM CONNECTOR jack to this unit (see page 24).

⑨ AC power supply cable

Connect to the AC wall outlet (see page 25).

Remote control

This section describes the functions of the remote control used to control this unit. Some buttons marked with an asterisk (*) share the common functions between the YSP and TV/AV operation modes (24).



You can also control other components using the remote control once you set the appropriate remote control codes. See “Controlling other components” on page 80 for details.

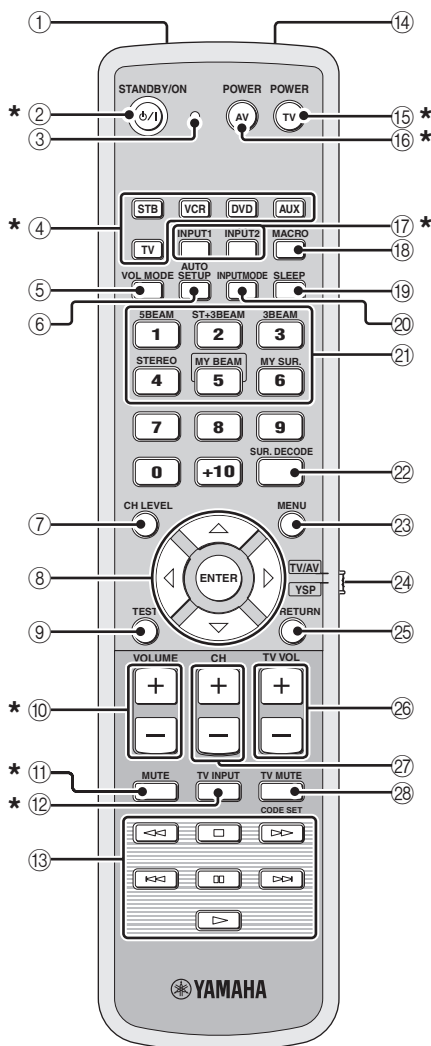

① Infrared window

Outputs infrared control signals. Aim this window at the component you want to operate.

② STANDBY/ON

Turns on the power of this unit or sets it to the standby mode (see page 27).

③ Transmission indicator

Lights up when infrared control signals are being output.

④ Input selector buttons

Use to select an input source (STB, VCR, DVD, AUX, or TV).

⑤ VOL MODE

Turns on or off the volume modes (see page 53).

⑥ AUTO SETUP

Enters the AUTO SETUP menu (see page 31).

⑦ CH LEVEL

Adjusts the volume level of each channel (see page 68).

⑧ Cursor buttons $\triangle / \nabla / \triangleleft / \triangleright$, ENTER

Select and adjust SET MENU items.

⑨ TEST

Outputs a test tone when adjusting the output level of each channel (see page 67).

⑩ VOLUME +/-

Increases or decreases the volume level of this unit (see page 43).

⑪ MUTE

Mutes the sound. Press again to restore the audio output to the previous volume level (see page 43).

⑫ TV INPUT

Toggles between the input sources on the TV (see page 80).

⑬ DVD player/VCR control buttons

Control your DVD player or VCR (see pages 81 and 82).

⑭ My Beam microphone

Collects the test tones from this unit when using the My Beam auto-adjust function (see page 51).

⑮ TV POWER

Turns on the power of your TV or sets it to the standby mode (see page 80).

⑯ AV POWER

Turns on the power of the selected component or sets it to the standby mode (see pages 81 and 82).

⑰ INPUT1/INPUT2

Switches the input source on your TV (see page 80).

18 MACRO

Use to set the TV macro (see page 83).

19 SLEEP

Sets the sleep timer (see page 54).

20 INPUTMODE

Toggles between input modes (AUTO, DTS, and ANALOG) (see page 70).

21 Beam mode buttons

Change the beam mode settings (see pages 44, 50, and 51).

22 SUR. DECODE

Selects the surround mode for playback (see page 47).

23 MENU

Displays the setup menu on your TV monitor (see pages 33 and 57).

24 Operation mode selector

Selects the operation mode of this unit. Select YSP when operating this unit and select TV/AV when operating your TV or other AV components.

25 RETURN

Returns to the previous SET MENU screen.

26 TV VOL +/-

Adjusts the volume level of your TV (see page 80).

27 CH +/-

Changes the channels of your TV, digital satellite tuner, cable TV tuner, or VCR (see pages 80 and 82).

28 TV MUTE, CODE SET

Mutes the audio output of your TV (see page 80).
Sets up remote control codes (see page 79).

This section describes the functions of the remote control used to control other components when the TV/AV mode is selected with the operation mode selector (④).

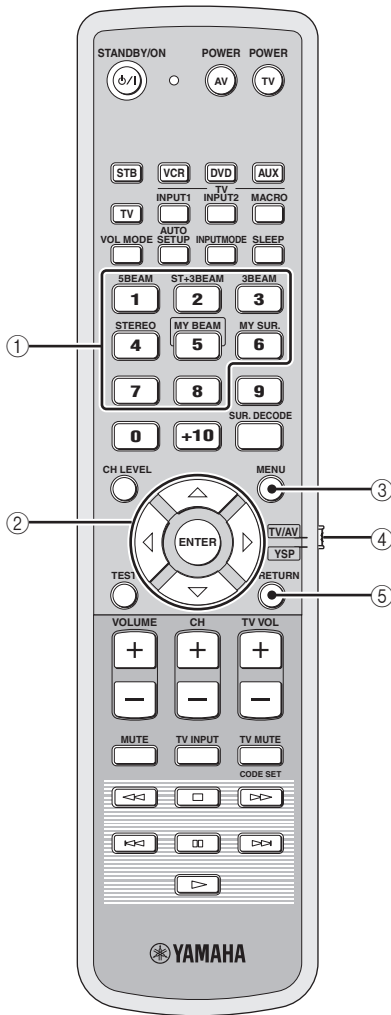

① **Numeric buttons**

Enter numbers.

② **Cursor buttons** $\triangle / \nabla / \triangleleft / \triangleright$, **ENTER**

Use to select DVD menu items.

③ **MENU**

Displays the DVD menu.

④ **Operation mode selector**

Selects the operation mode of this unit. Select YSP when operating this unit and select TV/AV when operating your TV or other AV components.

⑤ **RETURN**

Use to return to the previous DVD menu screen or exit from the DVD menu.

Installation

This section describes a suitable installation location to install this unit using a rack.

Depending on your installation environment, connections with external components can be done before installing this unit. We recommend that you temporarily place and arrange all components, including this unit, in order to decide which procedure should come first.

Before installing this unit

This unit creates surround sound by reflecting projected sound beams off the walls of your listening room. The surround sound effects produced by this unit may not be sufficient when this unit is installed in the following locations.

- Rooms with walls inadequate for reflecting sound beams
- Rooms with acoustically absorbent walls
- Rooms with measurements outside the following range: W (3 to 7 m (10 to 23 ft)) x H (2 to 3.5 m (7 to 11.5 ft)) x D (3 to 7 m (10 to 23 ft))
- Rooms with less than 1.8 m (6 ft) from the listening position to this unit
- Rooms where objects such as furniture are likely to obstruct the path of sound beams
- Rooms where the listening position is close to the walls
- Rooms where the listening position is not in front of this unit



- You can enjoy surround sound by selecting My Surround (see page 45) as the beam mode even if your listening room may not fulfill the above conditions (except when the listening position is not directly facing toward the front of this unit).
- You can also enjoy surround sound by selecting stereo playback (see page 50) or My Beam (see page 51) as the beam mode even if your listening room may not fulfill the above conditions.

Make sure you leave an adequate amount of ventilation space so that heat can escape. Make at least 5 cm (2 in) of space above this unit.

Notes

- We do not recommend putting this unit directly on the floor of your listening room. Please install this unit using a rack.
- This unit weighs 8.5 kg (18 lbs 12 oz). Be sure to install this unit where it will not fall subject to vibrations, such as from an earthquake, and where it is out of the reach of children.
- When using a cathode-ray tube (CRT) TV, do not install this unit directly above your TV.
- This unit is shielded against magnetic rays. However, if the picture on your TV screen becomes blurred or distorted, we recommend moving this unit away from your TV.

Installing this unit

Install this unit where there are no obstacles such as furniture obstructing the path of sound beams. Otherwise, the desired surround sound effects may not be achieved. You may install this unit in parallel with the wall or in the corner.

Parallel installation

Install this unit in the exact center of the wall when it is measured from the left and right corners.

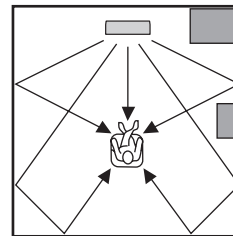

An object, such as furniture

Corner installation

Install this unit in the corner at a 40° to 50° angle from the adjacent walls.

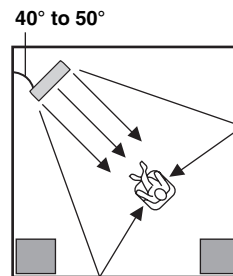

An object, such as furniture

■ Installation examples

Example 1

Install this unit as close to the exact center of the wall as possible.

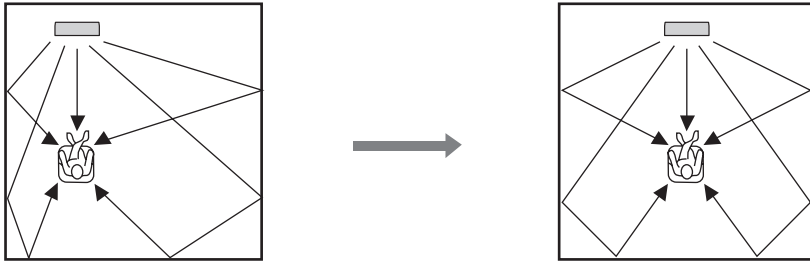

Example 2

Install this unit so that the sound beams can be reflected off the walls.

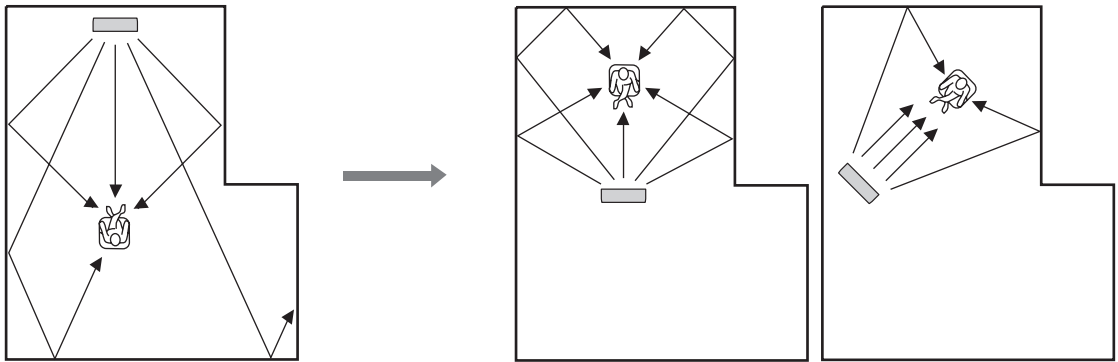

Example 3

Install this unit as close to the exact front of your normal listening position as possible.

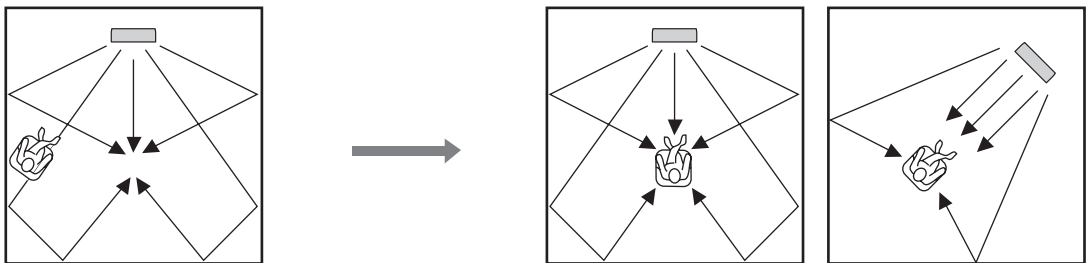

■ Using a rack

Install this unit under your TV in a commercially available rack.

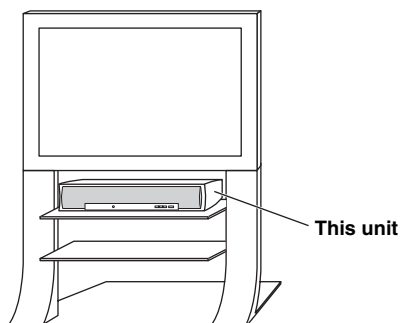

Note

Make sure that the rack is large enough to allow adequate ventilation space around this unit (see page 13) and that it is strong enough to support the weight of both this unit and your TV.

Connections

This unit is equipped with the following types of audio/video input/output jacks/terminal:

For audio input

- 2 optical digital input jacks
- 1 coaxial digital input jacks
- 2 sets of analog input jacks

For audio output

- 1 subwoofer output jack

For video output

- 1 analog output jack

Use these jacks/terminal to connect external components such as your TV, DVD player, VCR, digital satellite tuner, cable TV tuner, digital air wave tuner, and game console. Further, by connecting a subwoofer to this unit, you can enjoy reinforced low-bass sounds. For details on how to connect various types of external components to this unit, see pages 18 to 24.

CAUTION

- Do not connect this unit or other components to the mains power until all connections between components are complete.
- Unplug the AC power supply cable before changing connections, moving or cleaning this unit.

— Audio connection
— Video connection

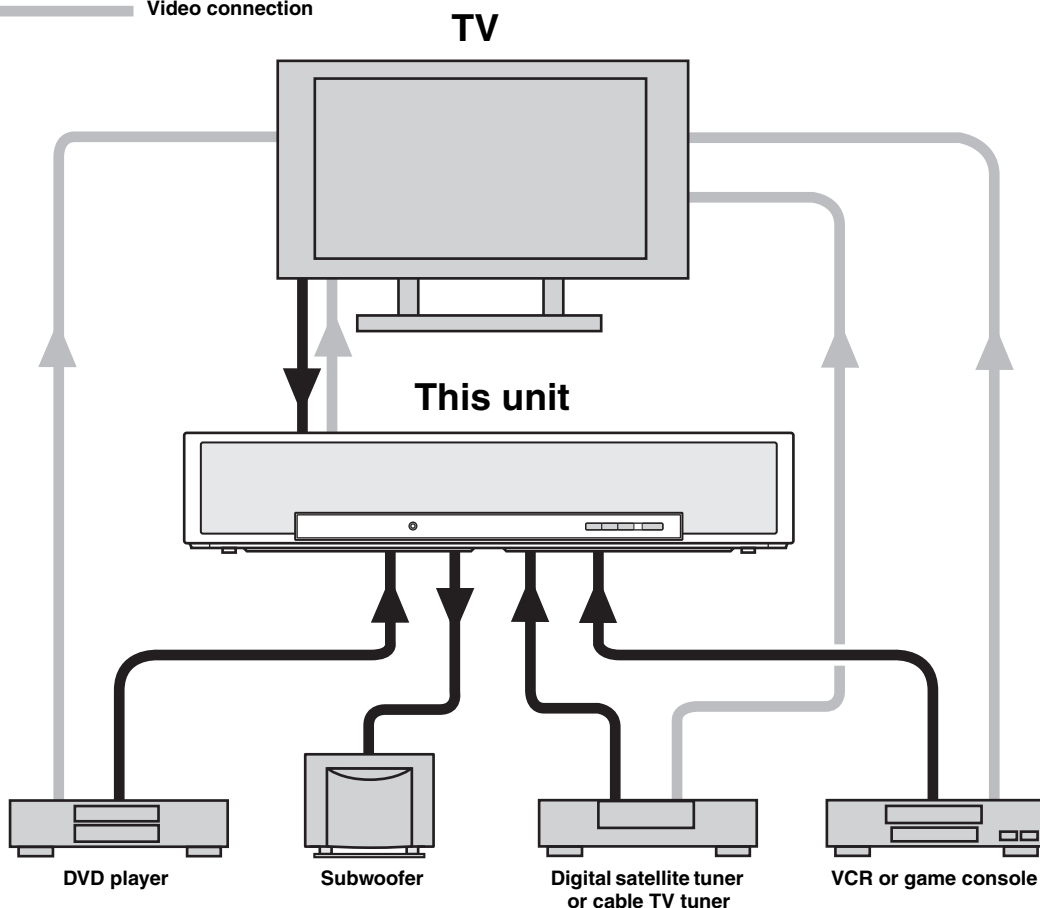

Before connecting components

■ Cables used for connections

Audio

1 Audio pin cable (supplied)

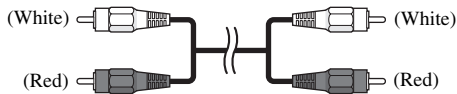

2 Optical cable (supplied)



3 Digital audio pin cable (supplied)

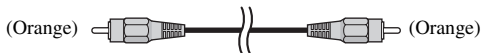

4 Subwoofer pin cable



5 System connector cable

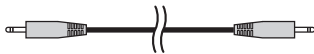

Video

1 OSD video pin cable (supplied)



■ Notes on connecting the optical cable

- Pull out the cap before connecting the optical cable. When you are not using the optical cable, be sure to put the cap back in place.
- When inserting the cable into the optical digital jack, make sure the direction is correct.



■ Affixing cables

To prevent cables from becoming unplugged, place the supplied cable clamp with the open side facing upward, attach it to the rear panel of this unit in a suitable position, and then affix cables in the cable clamp.

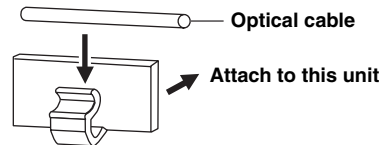

Connecting a TV

For audio connection, connect the analog audio output jacks on your TV to the TV/STB AUDIO INPUT jacks on this unit. If your TV has an optical digital output jack, connect the optical digital output jack on your TV to the TV/STB OPTICAL DIGITAL INPUT jack on this unit.

For video connection, connect the video input jack on your TV to the VIDEO OUT jack on this unit to display the OSD for easy viewing when you adjust the system parameters in SET MENU.



To prevent the optical cable from being unplugged, affix the optical cable in the supplied cable clamp (see page 17).

Note

If you make analog and optical digital audio connections at the same time as shown in the illustration below, the digital audio signals input at the TV/STB OPTICAL DIGITAL INPUT jack take priority over the analog audio signals input at the TV/STB AUDIO INPUT jacks.

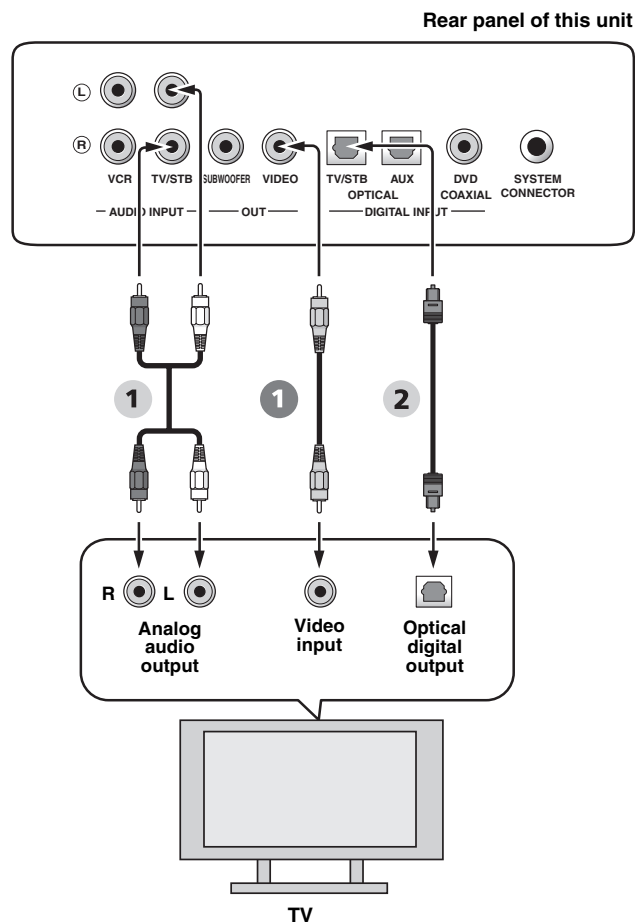

Video

- 1** OSD video pin cable

Audio

- 1** Audio pin cable
- 2** Optical cable

Connecting a DVD player/recorder

Connect the coaxial digital output jack on your DVD player/recorder to the DVD COAXIAL DIGITAL INPUT jack on this unit. When you connect this unit to your DVD/VCR combo player/recorder, connect the analog audio output jacks on your DVD/VCR combo player/recorder to the VCR AUDIO INPUT jacks on this unit in addition to the coaxial digital audio connection.



To prevent the optical cable from being unplugged, affix the optical cable in the supplied cable clamp (see page 17).

Notes

- Check that your DVD player/recorder is properly set to output Dolby Digital and DTS digital audio signals. If not, adjust the system settings of your DVD player/recorder. For details, refer to the operation manual supplied with your DVD player/recorder.
- If your DVD player/recorder does not have a coaxial digital output jack, make an optical digital audio connection instead (see page 23).

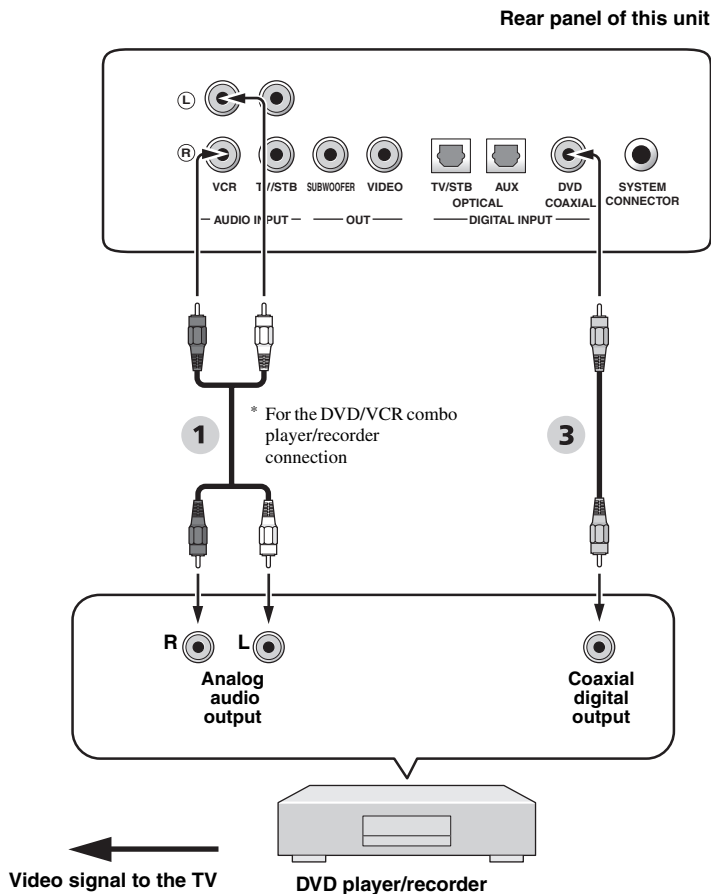

Audio

- 1 Audio pin cable
- 3 Digital audio pin cable

Connecting a digital satellite tuner or a cable TV tuner

Connect the optical digital output jack on your digital satellite tuner or cable TV tuner to the TV/STB OPTICAL DIGITAL INPUT jack on this unit. Connect the analog audio output jacks on your digital satellite tuner or cable TV tuner to the TV/STB AUDIO INPUT jacks on this unit.



To prevent the optical cable from being unplugged, affix the optical cable in the supplied cable clamp (see page 17).

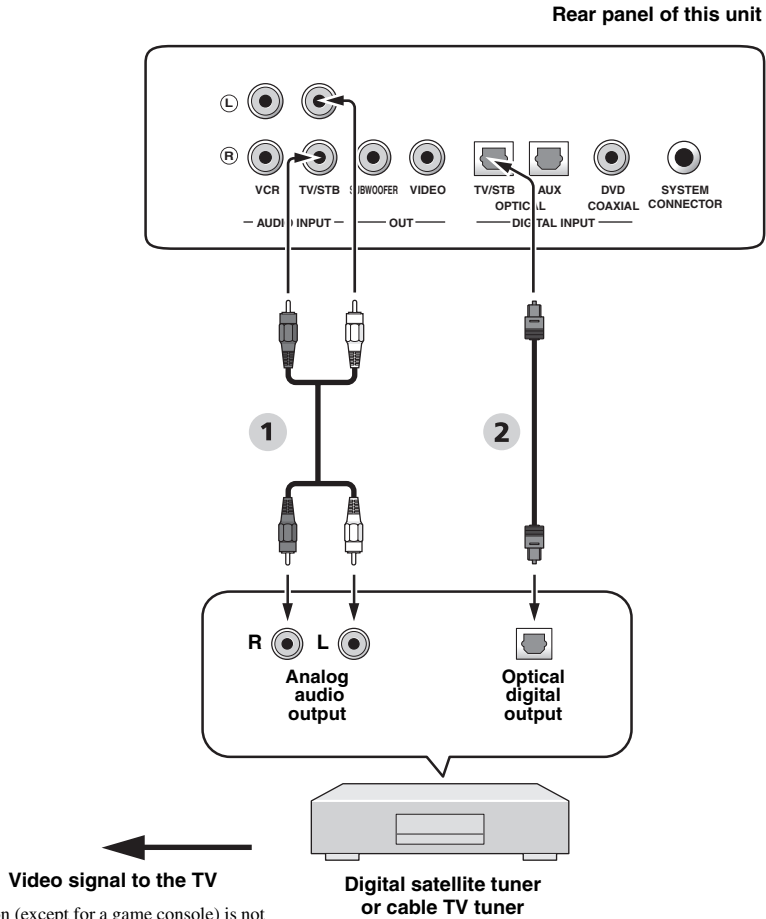

* This connection (except for a game console) is not necessary if your TV has a built-in digital satellite tuner, cable TV tuner, or digital airwave tuner.

Audio

- 1 Audio pin cable
- 2 Optical cable

Connecting a digital airwave tuner

Connect the TV/STB AUDIO INPUT jacks on this unit to the analog audio output jacks on your TV. Connect the optical digital output jack on your digital airwave tuner to the TV/STB OPTICAL DIGITAL INPUT jack on this unit in addition to the analog audio connection. By doing so, you can enjoy both analog and digital broadcasts.



To prevent the optical cable from being unplugged, affix the optical cable in the supplied cable clamp (see page 17).

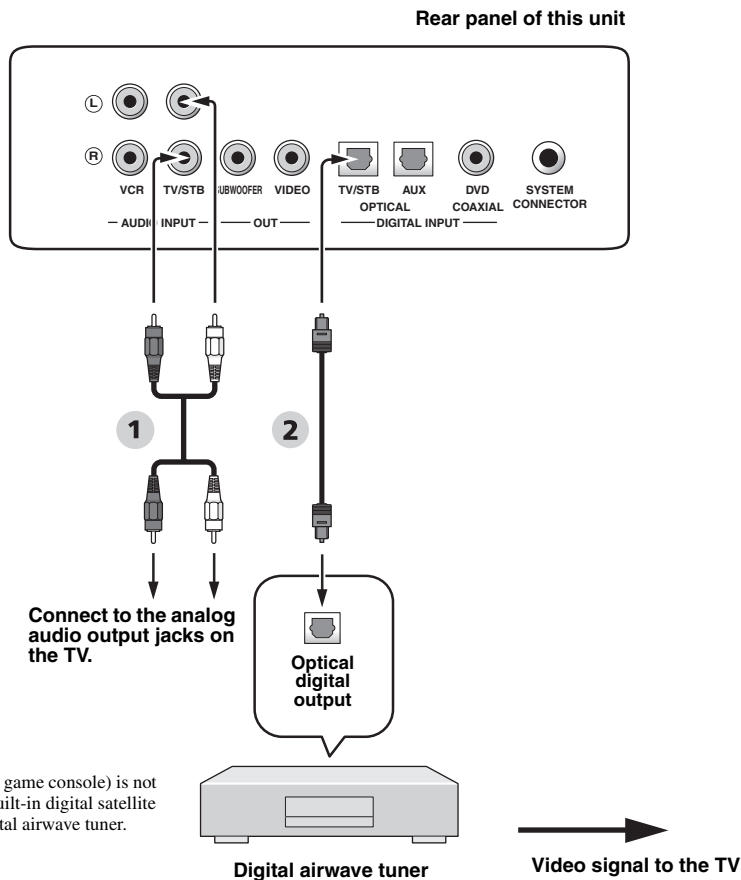

* This connection (except for a game console) is not necessary if your TV has a built-in digital satellite tuner, cable TV tuner, or digital airwave tuner.

Audio

- 1** Audio pin cable
- 2** Optical cable

Connecting a VCR

To connect a VCR, connect the analog audio output jacks on your VCR to the analog audio input jacks (VCR L/R) on this unit.

Connect red plugs to the right jacks and white plugs to the left jacks.

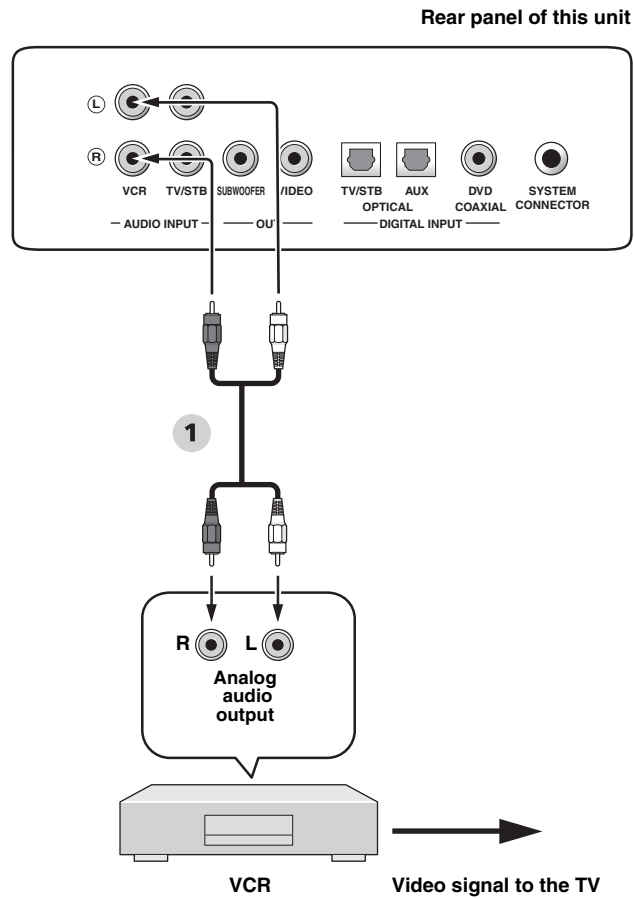

Audio

1 Audio pin cable

Connecting other external components

If your component supports optical digital connections, connect the optical digital output jack on your component (e.g., DVD player/recorder) to the AUX OPTICAL DIGITAL INPUT jack on this unit.



To prevent the optical cable from being unplugged, affix the optical cable in the supplied cable clamp (see page 17).

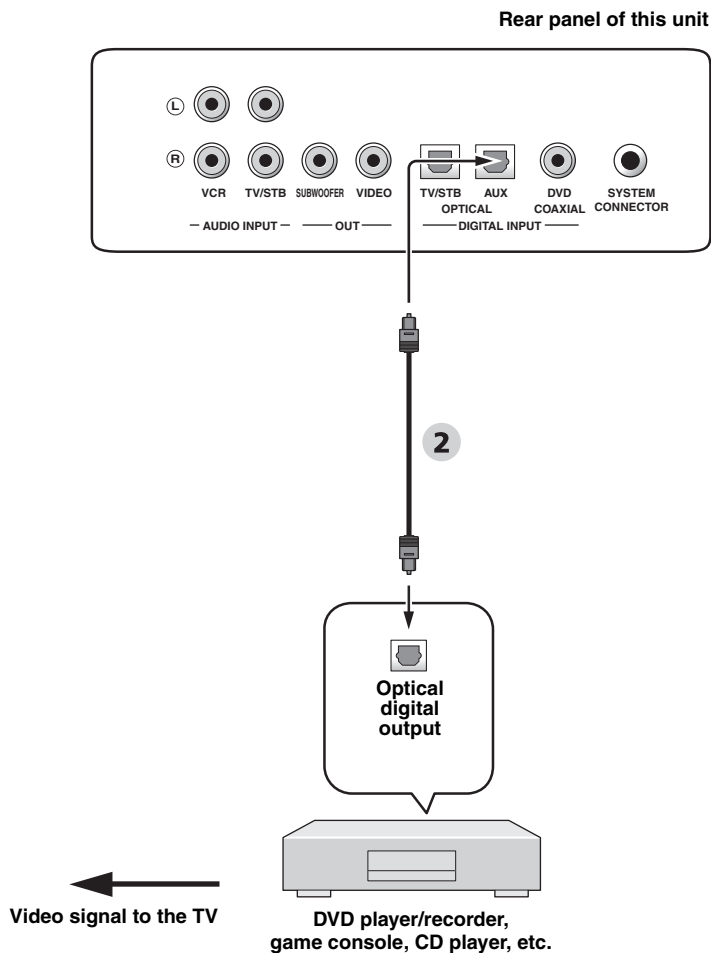

Audio

2 Optical cable

Connecting a subwoofer

Connect the monaural input jack on your subwoofer to the SUBWOOFER jack on this unit.

This connection alone does not output sound from the connected subwoofer. To output sound from the connected subwoofer, turn on the power of your subwoofer and then run AUTO SETUP (see page 31) or select SWFR for BASS OUT in SUBWOOFER SET (see page 62).

When connecting a Yamaha subwoofer equipped with a SYSTEM CONNECTOR terminal, connect it to the SYSTEM CONNECTOR terminal on this unit. If the subwoofer is connected using a system type connection, changing the power mode of this unit controls the power mode of the subwoofer.

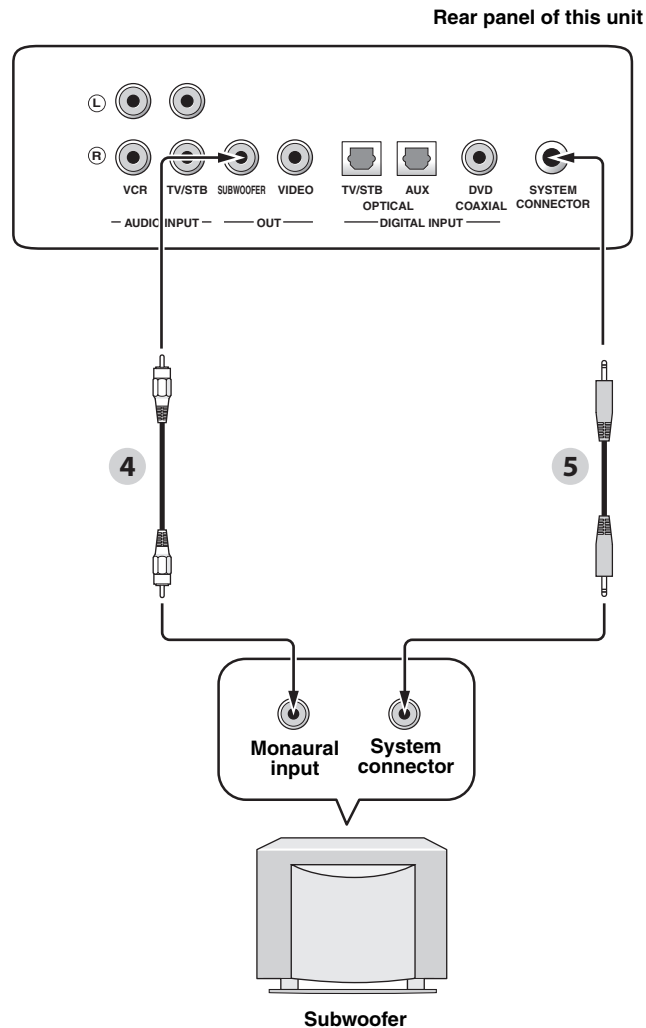

Audio

- 4 Subwoofer pin cable
- 5 System connector cable

Connecting the AC power supply cable

Once all other connections are complete, plug the AC power supply cable into the AC wall outlet.

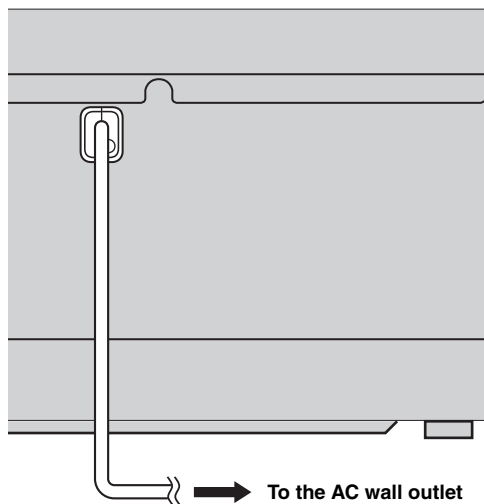

Getting started

Installing batteries in the remote control

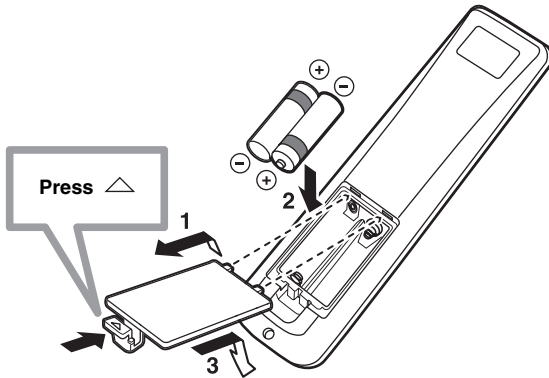

1 Press and hold the mark on the battery cover and then open the cover.

2 Insert the two supplied batteries (AA, R6, UM-3) into the battery compartment.

Make sure you insert the batteries according to the polarity markings (+/-).

3 Close the battery cover.

Notes

- Change all of the batteries if you notice the following conditions: the operation range of the remote control decreases or the transmission indicator does not light up or becomes dim.
- Do not use old batteries together with new ones.
- Do not use different types of batteries (such as alkaline and manganese batteries) together. Read the packaging carefully as these different types of batteries may have the same shape and color.
- Exhausted batteries may leak. If the batteries have leaked, dispose of them immediately. Avoid touching the leaked material or letting it come into contact with clothing, etc. Clean the battery compartment thoroughly before installing new batteries.
- Do not throw away batteries with general house waste. Dispose of them correctly in accordance with your local regulations.
- The memory stored in the remote control may be erased in the following cases:
 - The remote control is left without batteries for more than two minutes.
 - Exhausted batteries remain in the remote control.
 - The buttons on the remote control are accidentally pressed when you change batteries.
- If the memory stored in the remote control is unwantedly erased, insert new batteries and set the remote control codes again.



Remove the transparent sheet before using the remote control.

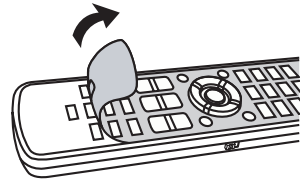

Operation range of the remote control

The remote control transmits a directional infrared beam. Use the remote control within 6 m (20 ft) of this unit and point it toward the remote control sensor of this unit during operation.

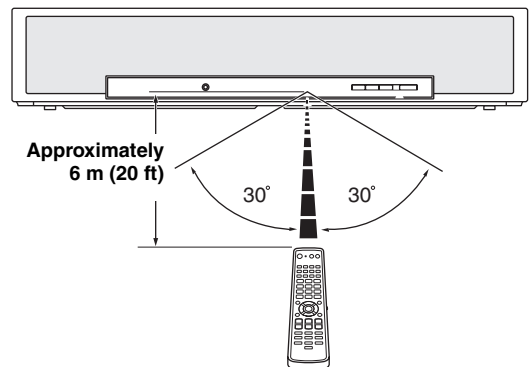

Notes

- Do not spill water or other liquids on the remote control.
- Do not drop the remote control.
- Do not leave or store the remote control in the following places:
 - places of high humidity, such as near a bath
 - places of high temperatures, such as near a heater or a stove
 - places of extremely low temperatures
 - dusty places
- Do not expose the remote control sensor of this unit to direct sunlight or lighting such as inverted fluorescent lamps.
- If the batteries grow old, the effective operation range of the remote control decreases considerably. If this happens, replace the batteries with two new ones as soon as possible.

Turning on this unit or setting it to the standby mode

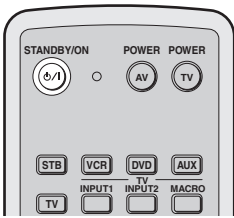
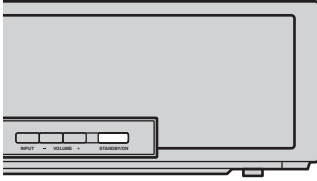

- Press **STANDBY/ON** again to set this unit to the standby mode.

Note

When this unit is in the standby mode, only **STANDBY/ON** on the front panel or on the remote control is operational, and the other control buttons on the front panel or on the remote control are not operational until the power of this unit is turned on.

- Press **STANDBY/ON** to turn on the power of this unit.

The volume level appears in the front panel display, and the current input source and beam mode are displayed.

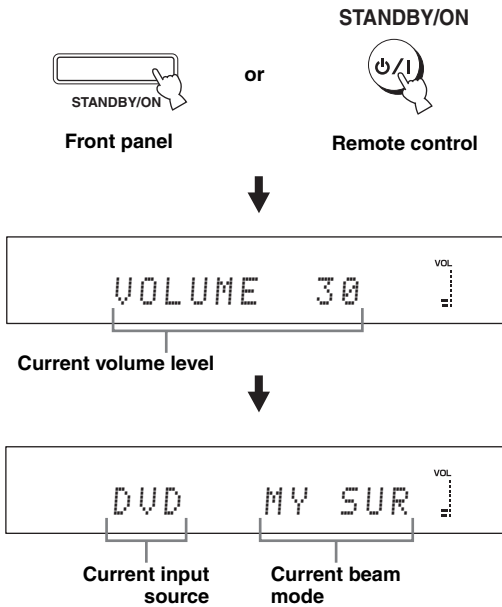

Using SET MENU

Displaying the OSD (on-screen display)

This section describes how to display the OSD (on-screen display) of this unit on your TV screen and to set the parameters for your listening room. Once this is complete, you can enjoy real surround sound while watching TV in the comfort of your own home.

1 Check that the video input jack on your TV is connected to the VIDEO OUT jack on this unit to display the OSD of this unit.

2 Press STANDBY/ON to turn on the power of this unit.



Front panel

or

STANDBY/ON



Remote control

3 Turn on the power of your TV.

The following screen appears on your TV.

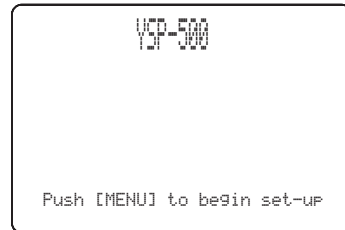

OSD screen example

If the OSD does not appear, use the remote control supplied with your TV to switch the video input until the OSD appears.

The flow chart of SET MENU

The following diagram illustrates the overall flow of the setup procedure.

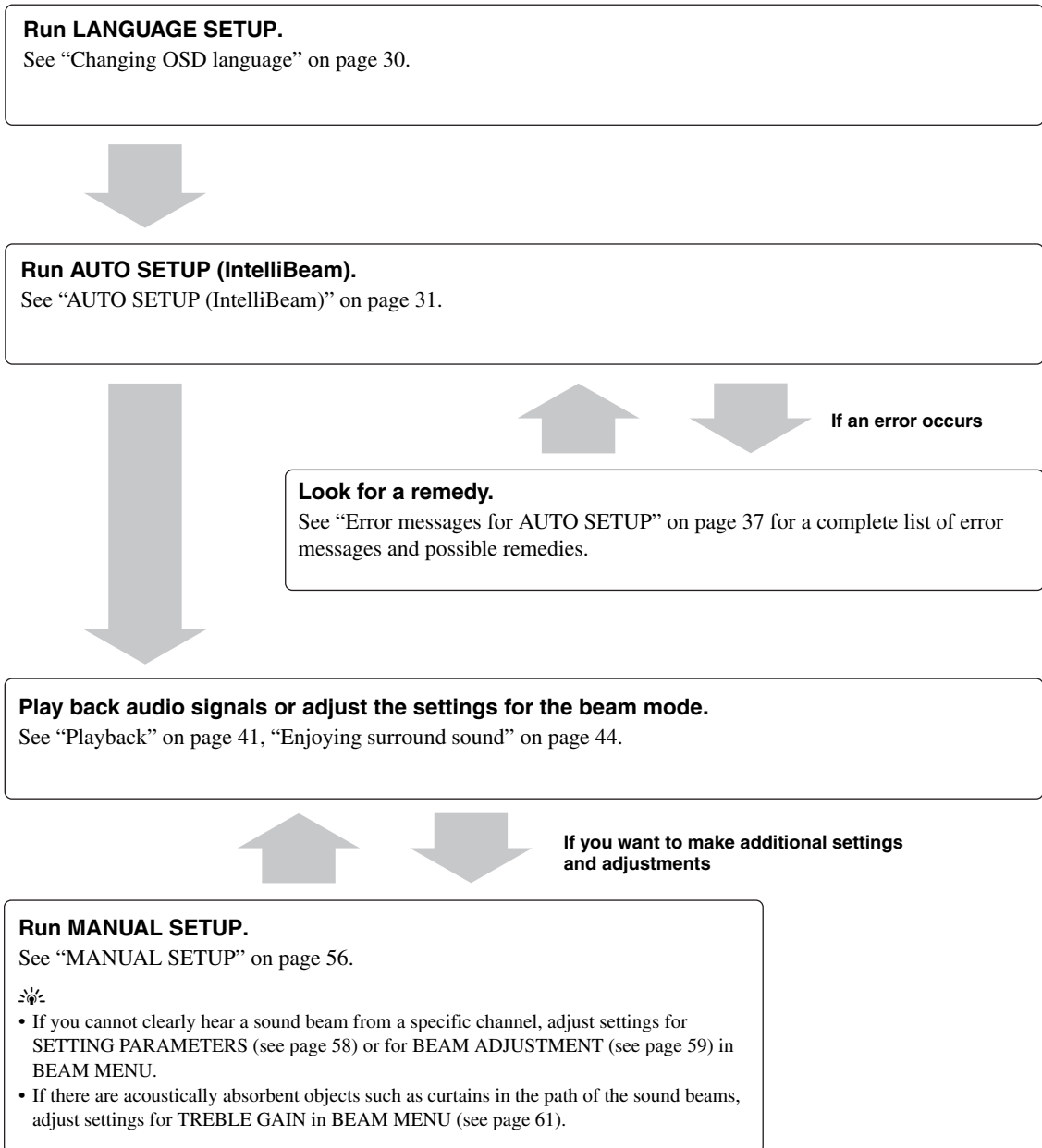

Changing OSD language

This feature allows you to select the language of your choice that appears in SET MENU of this unit.

1 Set the operation mode selector to YSP.

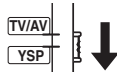

2 Press MENU.

The SET MENU screen appears on your TV.

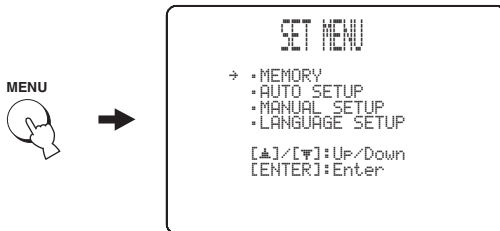

- The control buttons used for SET MENU are displayed at the bottom of the screen.
- To return to the previous screen while using SET MENU, press RETURN.
- To exit from SET MENU, press MENU once more.
- You can also perform the following operations while viewing information in the front panel display.

3 Press ▲ / ▼ to select LANGUAGE SETUP, and press ENTER.

The following screen appears on your TV.

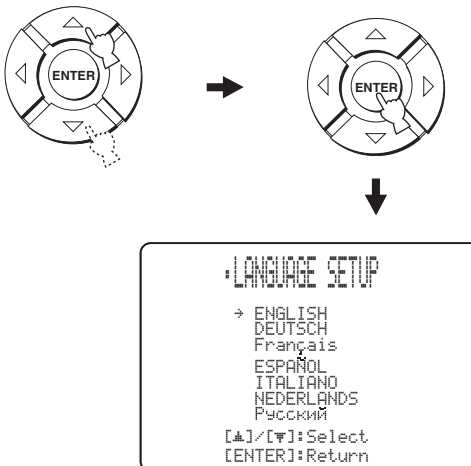

4 Press ▲ / ▼ to select the desired language, and press ENTER.

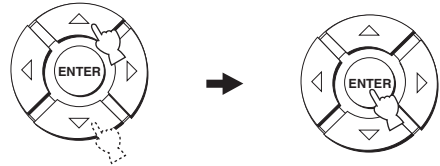

Choices: **ENGLISH** (English), **DEUTSCH** (German), **Français** (French), **ESPAÑOL** (Spanish), **ITALIANO** (Italian), **NEDERLANDS** (Dutch), **Русский** (Russian)

AUTO SETUP (IntelliBeam)

This unit creates a sound field by reflecting sound beams on the walls of your listening room and by broadening the cohesion of all the channels. Just as you would arrange the speaker position of other audio systems, you need to set the beam angle to enjoy the best possible sound from this unit.

This unit employs the beam optimization and sound optimization features with the aid of the supplied IntelliBeam microphone, allowing you to avoid troublesome listening-based setup and achieving highly accurate sound adjustments that best match your listening environment. We call these two features “**IntelliBeam**” generically.

Beam optimization:

This feature optimizes the beam angle so that the parameter best matches your listening environment.

Sound optimization:

This feature optimizes the beam delay, volume, and quality so that the parameters best match your listening environment.

The flow chart of AUTO SETUP

This unit performs a series of checks to optimize the beam angle, delay, volume, and quality. You can choose to optimize all or part of the parameters.

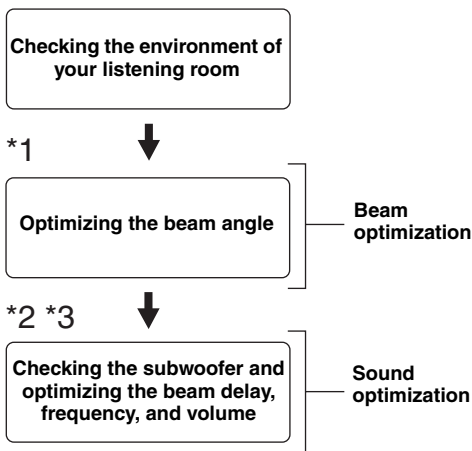

Notes

- *1 The beam angle checking procedure is skipped if SOUND OPTIMZ only is selected.
- *2 The sound optimization procedure is skipped if BEAM OPTIMZ only is selected.
- *3 The subwoofer checking procedure is skipped if BEAM OPTIMZ only is selected.

Installing the IntelliBeam microphone

The supplied IntelliBeam microphone collects and analyzes the sound that this unit produces in your actual listening environment. Follow the procedure below to connect the IntelliBeam microphone to this unit and make sure that the IntelliBeam microphone is placed in a proper location and that there are no large obstacles between the IntelliBeam microphone and the walls in your listening room.

Notes

- After you have completed the AUTO SETUP procedure, be sure to disconnect the IntelliBeam microphone.
- The IntelliBeam microphone is sensitive to heat.
 - Keep it away from direct sunlight.
 - Do not place it on top of this unit.
- Do not connect the IntelliBeam microphone to an extension cable as doing so may result in an inaccurate sound optimization.
- An error may occur during the AUTO SETUP procedure if the IntelliBeam microphone is not properly placed in your listening room. To avoid the possibility of an error:
 - Do not place the IntelliBeam microphone to the extreme right or left from the center of this unit.
 - Do not place the IntelliBeam microphone within 1.8 m (6.0 ft) from the front of this unit.
 - Do not place the IntelliBeam microphone more than 1 m (3.3 ft) upper or lower from the center height of this unit.
- Make sure that there are no obstacles between the IntelliBeam microphone and the walls in your listening room as these objects obstruct the path of sound beams. However, any objects that are in contact with the walls will be regarded as a protruding part of the walls.
- The best possible results are achieved if the IntelliBeam microphone is placed at the same height as your ears would be when you are seated in your listening position. However, if this is not possible, you can manually fine-tune the sound beam angle and balance the sound beam output levels using MANUAL SETUP (see page 56) once the AUTO SETUP procedure is completed.
- If a subwoofer with adjustable volume and crossover/high-cut frequency controls is connected to this unit, set the volume between 10 and 12 o'clock as viewed on a conventional clockface and set the crossover/high-cut frequency to the maximum.

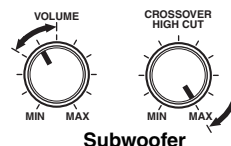

1 Press STANDBY/ON to turn off the power of this unit.

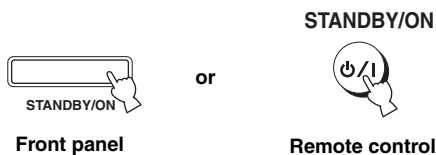

2 Connect the supplied IntelliBeam microphone to the INTELLIBEAM MIC jack on the front panel.

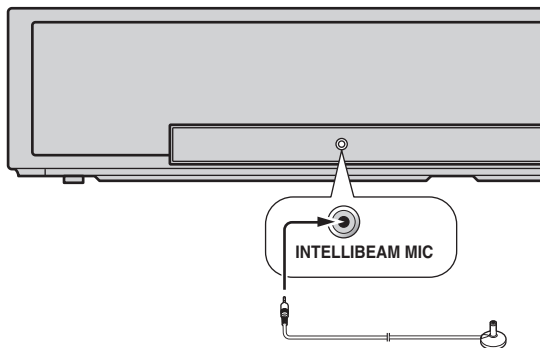

3 Place the IntelliBeam microphone on a flat level surface more than 1.8 m (6.0 ft) from the front of the unit and within 1 m (3.3 ft) upper or lower from the center height of the unit with the IntelliBeam microphone facing upward at your normal listening position.

Note

Be sure to place the IntelliBeam microphone on an imaginary center line drawn from this unit.



You may want to use the supplied cardboard microphone stand to affix the IntelliBeam microphone at the same height as your ears would be when you are seated in your listening position.

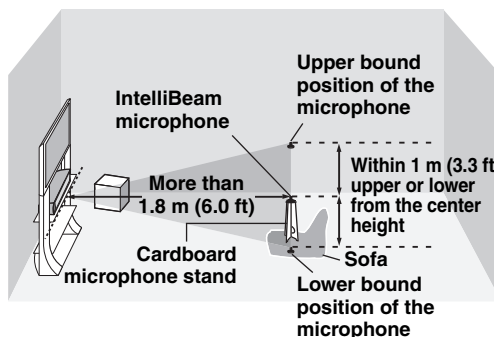

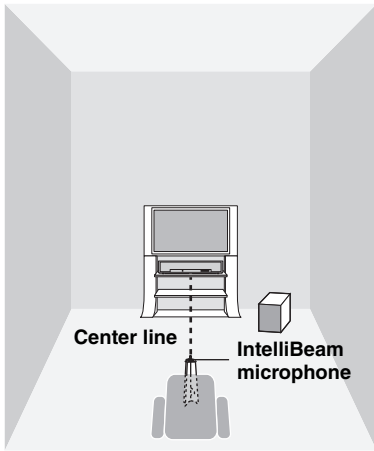

Using AUTO SETUP (IntelliBeam)

Once the IntelliBeam microphone is firmly connected to this unit and properly placed in your listening room, follow the procedure below to start the AUTO SETUP procedure.

You can also enter the AUTO SETUP procedure simply by pressing and holding AUTO SETUP for more than two seconds. In this case, this unit performs both of the beam optimization and sound optimization procedures.

■ Assembling the supplied cardboard microphone stand

You will find three separate parts (one circular part and two longitudinal parts) of the cardboard microphone stand originally put together.

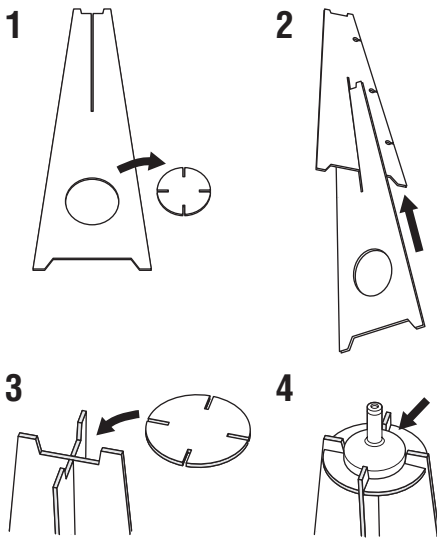
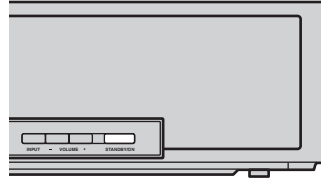

- 1** Disassemble the three parts of the cardboard microphone stand originally put together.
- 2** Insert one of the longitudinal part into the crevice of the other longitudinal part.
- 3** Place the circular part on top of the two combined longitudinal parts.
- 4** Place the supplied IntelliBeam microphone on top of the circular part.

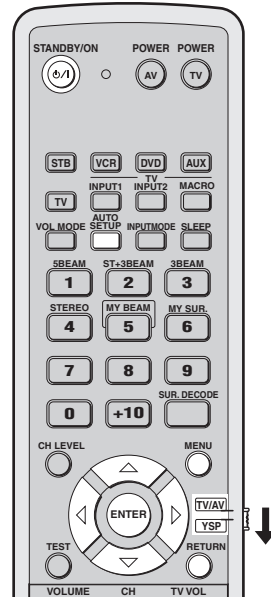

SETUP

English

Notes

- Make sure that your listening room is as quiet as possible while this unit is performing the AUTO SETUP procedure.
 - To achieve the best results possible, evacuate yourself from your listening room until the AUTO SETUP procedure is completed so that you may not obstruct the path of sound beams.
 - Be advised that it is normal for loud test tones to be output during the AUTO SETUP procedure.
 - The AUTO SETUP procedure may not be run successfully if this unit is installed in one of the rooms described in “Before installing this unit” on page 13. In such cases, run MANUAL SETUP (see page 56) to manually adjust the corresponding parameters.
 - If an error occurs, an error buzzer is played, the AUTO SETUP procedure stops, and an error message appears on the screen. See “Error messages for AUTO SETUP” on page 37 for appropriate remedies.
- 
- The AUTO SETUP procedure takes about three minutes maximum. A chime is played when the AUTO SETUP procedure is run successfully.
 - If there are curtains in your listening room, we recommend following the procedure below.
 1. Open the curtains to improve sound reflection.
 2. Run BEAM OPTIMZ only.
 3. Close the curtains.
 4. Run SOUND OPTIMZ only.
 - You can save the settings optimized by the AUTO SETUP procedure (see page 38). A set of settings optimized according to the specific conditions of your listening environment can be recalled later depending on the varying conditions of your listening environment (see page 39).

1 Press STANDBY/ON to turn on the power of this unit.

If a subwoofer is connected to this unit, turn on the power of the subwoofer.

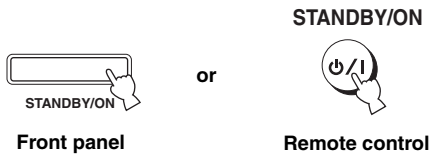

2 Set the operation mode selector to YSP.



3 Press MENU.

The SET MENU screen appears on your TV.



- The control buttons used for SET MENU are displayed at the bottom of the screen.
- To return to the previous screen while using SET MENU, press RETURN.
- To exit from the SET MENU screen, press MENU again.
- You can start the BEAM+SOUND OPTIMZ procedure simply by pressing and holding AUTO SETUP for more than two seconds. Steps 4 and 5 are skipped and then the screen shown in step 5 is displayed on your TV. Start the AUTO SETUP procedure from step 6.
- You can also perform the following operations in the front panel display.

4 Press ▲ / ▼ to select AUTO SETUP and press ENTER.

The following screen appears on your TV.

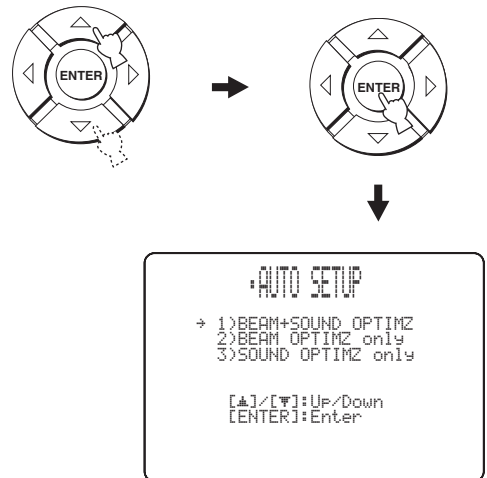

- 5 Press \triangle / ∇ to select BEAM+SOUND OPTIMZ, BEAM OPTIMZ only, or SOUND OPTIMZ only and then press ENTER.**

The following screen appears on your TV.

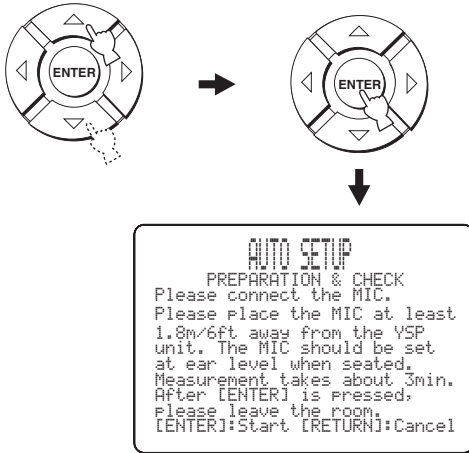

**BEAM+SOUND OPTIMZ
(Beam optimization and sound optimization)**

Use to optimize the beam angle, delay, volume, and quality so that the parameters best match your listening environment.

It is recommended that you should select this optimization feature in the following cases:

- If you make settings for the first time.
- If the unit has been relocated.
- If your listening room has been restructured.
- If the objects in your listening room (furniture, etc.) have been rearranged.

This menu takes about three minutes.

**BEAM OPTIMZ only
(Beam optimization only)**

Use to optimize the beam angle so that the parameter best matches your listening environment.

This menu takes about one minute.

**SOUND OPTIMZ only
(Sound optimization only)**

Use to optimize the beam delay, volume, and quality so that the parameters best match your listening environment.

It is recommended that you should select this optimization feature in the following cases:

- If you have opened or closed the curtains in your listening room before using this unit.
- If you have manually set the beam angle.

This menu takes about two minutes.

Note

You must optimize the beam angle in the BEAM OPTIMZ only procedure before starting the SOUND OPTIMZ only procedure.

- 6 Check the following points once again before starting the AUTO SETUP procedure.**

- Is the IntelliBeam microphone firmly connected to this unit?
- Is the IntelliBeam microphone placed in a proper location?
- Are there any large obstacles in between the IntelliBeam microphone and the walls in your listening room?

- 7 Press ENTER to start the AUTO SETUP procedure.**

The following screen appears on your TV and the AUTO SETUP procedure starts in 10 seconds. Leave the room quietly before starting the AUTO SETUP procedure.

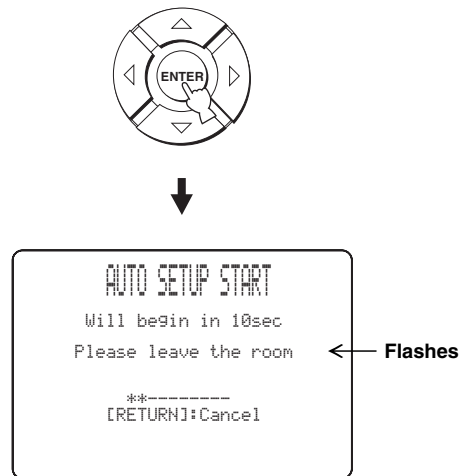

If an error occurs, an error buzzer is played and an error message is displayed. See “Error messages for AUTO SETUP” on page 37 for a complete list of error messages and their proper remedies. Follow the instructions and perform the AUTO SETUP procedure again.

8 Check that the following screen is displayed on your TV.

The results of the AUTO SETUP procedure are displayed on your TV.

Example 1

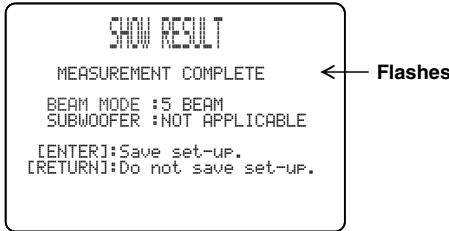

Example 2

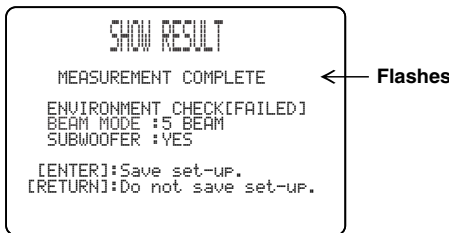

- If “ENVIRONMENT CHECK [FAILED]” is displayed, we recommend running the AUTO SETUP procedure again. For details, see step 9.
- If “SUBWOOFER : NOT APPLICABLE” is displayed even though a subwoofer is connected to this unit, increase the volume level of the subwoofer and run the AUTO SETUP procedure again.
- Depending on the environment of your listening room, the beam angle of front left and right, and surround left and right may be set to the same value even if “5 BEAM” is displayed as a result.

9 Press ENTER to confirm the results or press RETURN to cancel the results.

The following screen is displayed for two seconds and then disappears from your TV.

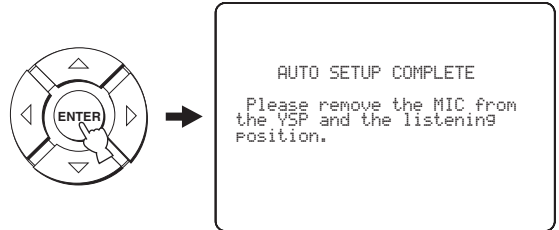

If “ENVIRONMENT CHECK [FAILED]” is displayed in step 8, the following screen is displayed after pressing ENTER. In this case, see ERROR E-1 in “Error messages for AUTO SETUP” on page 37. Press ENTER to exit AUTO SETUP and then run the procedure again from step 3.



10 Disconnect the IntelliBeam microphone from the INTELLIBEAM MIC jack on the front panel.

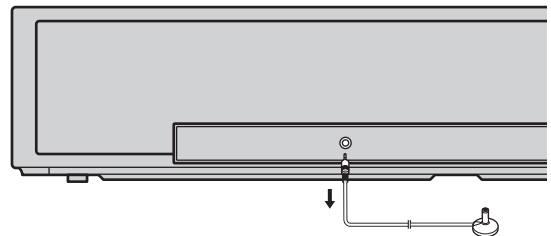

If you want to save and load settings, see “Using the system memory” on page 38.

■ Error messages for AUTO SETUP

Before the AUTO SETUP procedure starts

Error message	Cause	Remedy	See page
ERROR E-2 No MIC detected. Please check MIC connection and re-try.	The IntelliBeam microphone is not connected to this unit.	Connect the IntelliBeam microphone to this unit.	32

While the AUTO SETUP procedure is in progress

If one of the errors listed below except E-1 is displayed, press RETURN. In case you have started the AUTO SETUP procedure by pressing AUTO SETUP in step 3, run the procedure again from step 3 after the screen disappears. In case you have started the AUTO SETUP procedure by pressing MENU in step 3, run the procedure again from step 4 after the screen in step 3 is displayed. Run MANUAL SETUP if the problem is difficult to be saved.

Error message	Cause	Remedy	See page
ERROR E-1 Please test in quieter environment.	There is too much unwanted noise in your listening room.	Make sure that your listening room is as quiet as possible. You may want to choose certain hours during the day when there is not much noise coming from outside.	—
ERROR E-2 No MIC detected. Please check MIC connection and re-try.	The IntelliBeam microphone was disconnected while the AUTO SETUP procedure was in progress.	Make sure that the IntelliBeam microphone is firmly connected to this unit.	32
ERROR E-3 Unexpected control is detected. Please re-try.	Some other operations were performed on this unit while the AUTO SETUP procedure was in progress.	Do not perform any other operations while the AUTO SETUP procedure is in progress.	—
ERROR E-4 Please check MIC position. MIC should be set in front of YSP.	The IntelliBeam microphone is not placed in front of this unit.	Make sure that the IntelliBeam microphone is installed in front of this unit.	32
ERROR E-5 Please check MIC position. MIC should be set above 1.8m/6.0ft.	The IntelliBeam microphone is not placed in the right distance from this unit.	Make sure that the IntelliBeam microphone is installed more than 1.8 m (6.0 ft) from the front of this unit and within 1 m (3.3 ft) from the center height of this unit.	32
ERROR E-6 Volume level is lower than expected. Please check MIC position/connection and re-try.	The IntelliBeam microphone cannot collect the sound produced by this unit because the sound output level is too low.	Make sure that the IntelliBeam microphone is firmly connected to this unit and placed in a proper location. If the problem persists, contact the nearest authorized Yamaha service center for assistance.	32
ERROR E-7 Unexpected error happened. Please re-try.	An internal system error occurred.	Repeat the AUTO SETUP procedure.	—

Using the system memory

Convenient usage of the system memory

You can save the current settings adjusted in SET MENU in the system memory of this unit. It is handy to save certain settings according to the varying conditions of your listening environment. For example, if there are curtains in the path of sound beams, the effectiveness of the sound beams will vary depending on whether the curtains are open or closed.

When the curtains are open

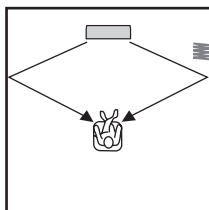

When the curtains are closed

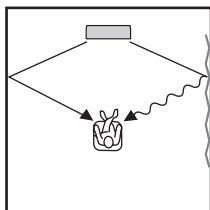

3 Press \triangle / ∇ to select MEMORY and press ENTER.

The following screen appears on your TV.

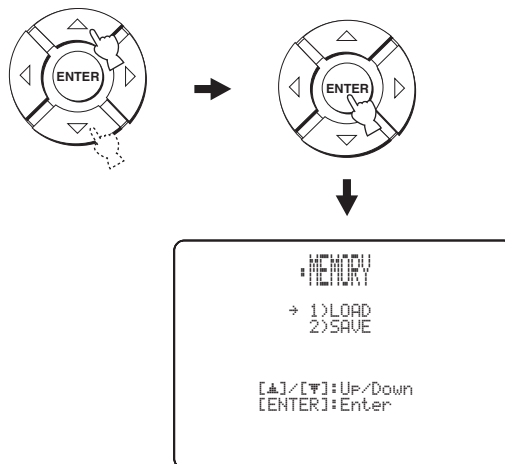

Saving settings

1 Set the operation mode selector to YSP.

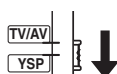

2 Press MENU.

The SET MENU screen appears on your TV.



- The control buttons used for SET MENU are displayed at the bottom of the screen.
- To return to the previous screen while using SET MENU, press RETURN.
- To exit from the SET MENU screen, press MENU once more.
- You can also perform the following operations in the front panel display.

4 Press \triangle / ∇ to select SAVE and press ENTER.

The following screen appears on your TV.

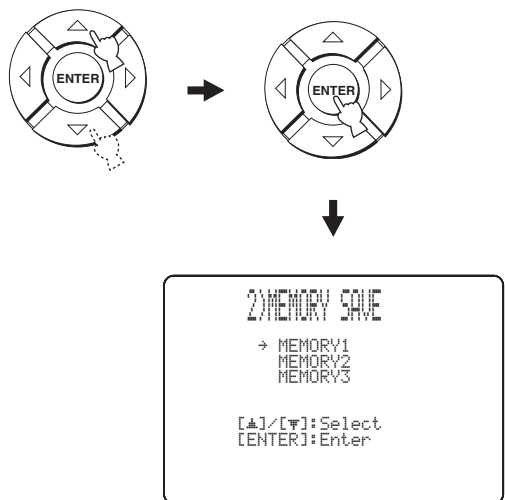

- 5 Press \triangle / ∇ to select MEMORY1, MEMORY2, or MEMORY3 and press ENTER.**

The following screen appears on your TV.

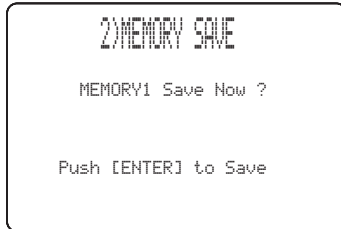
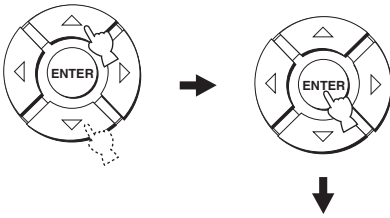

- 6 Press ENTER again.**

The new parameters are saved as MEMORY1, MEMORY2, or MEMORY3. Once the parameters are saved, the display returns to the SET MENU screen.

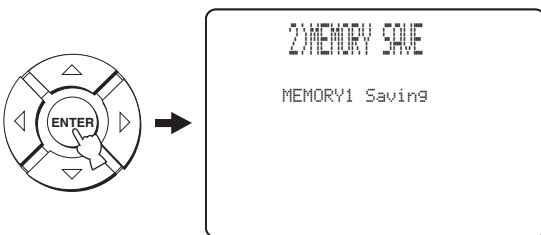

- 7 Press MENU to exit.**

The SET MENU screen disappears from your TV.



Loading settings

You can recall the settings saved in “Saving settings” on page 38 according to the varying conditions of your listening environment.

- 1 Set the operation mode selector to YSP.**

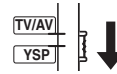

- 2 Press MENU.**

The SET MENU screen appears on your TV.



- The control buttons used for SET MENU are displayed at the bottom of the screen.
- To return to the previous screen while using SET MENU, press RETURN.
- To exit from the SET MENU screen, press MENU once more.
- You can also perform the following operations in the front panel display.

- 3 Press \triangle / ∇ to select MEMORY and press ENTER.**

The following screen appears on your TV.

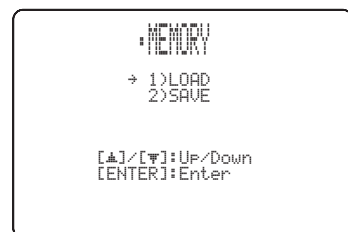
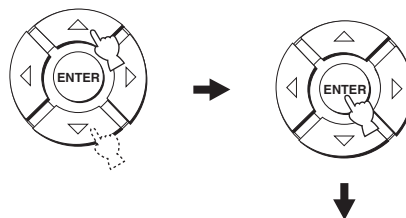

4 Press \triangle / ∇ to select LOAD and press ENTER.

The following screen appears on your TV.

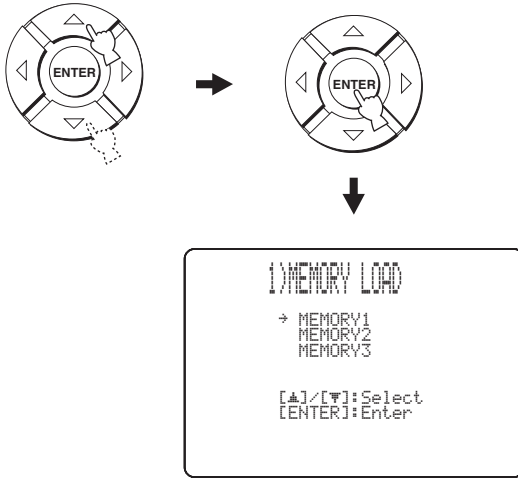

5 Press \triangle / ∇ to select MEMORY1, MEMORY2, or MEMORY3 and press ENTER.

The following screen appears on your TV.

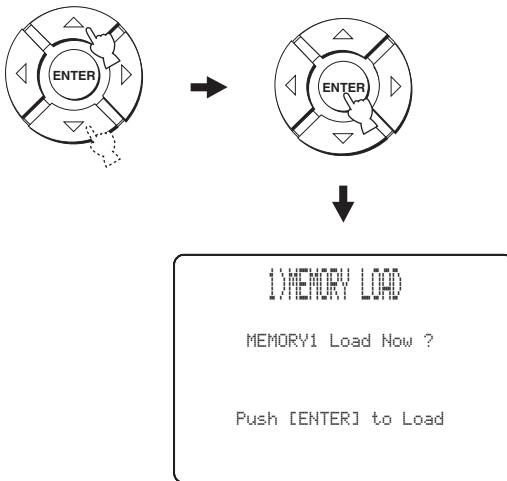

6 Press ENTER again.

The new parameters saved as MEMORY1, MEMORY2, or MEMORY3 are loaded. Once the parameters are loaded, the display returns to the SET MENU screen.

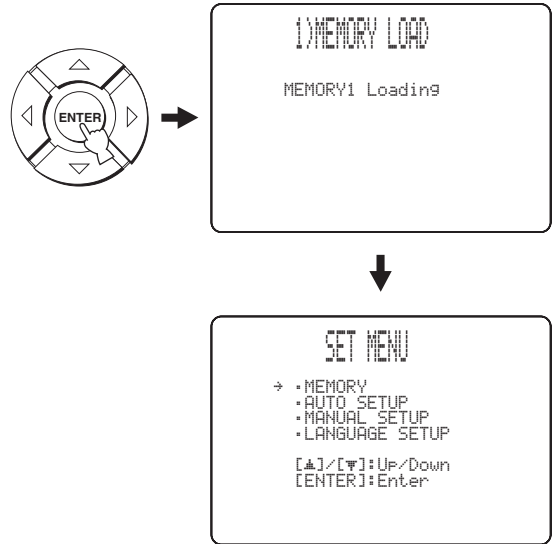

7 Press MENU to exit.

The SET MENU screen disappears from your TV.



Playback

Selecting the input source

You can play back sound from the components connected to this unit simply by pressing INPUT on the front panel repeatedly or pressing one of the input selector buttons (STB, VCR, DVD, AUX, or TV) on the remote control. The name of the selected input source and the type of corresponding input mode appear in the front panel display.



■ Front panel operations

Press **INPUT** on the front panel repeatedly to **toggle between TV/STB, VCR, DVD, and AUX.**

The name of the corresponding input source and the type of current input mode are displayed in the front panel display.

■ Remote control operations



In addition to controlling this unit, you can also operate other AV components if you set up the remote control with the appropriate remote control codes and set the operation mode selector to TV/AV to change the control area (see page 79).

Press TV to play back a TV program.

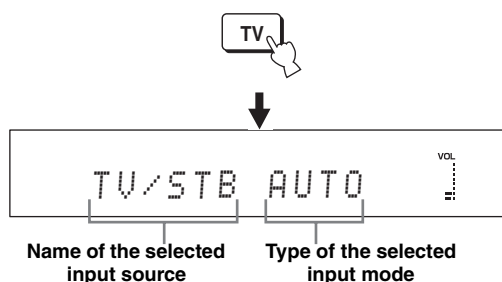

Press STB to play back a satellite broadcast.

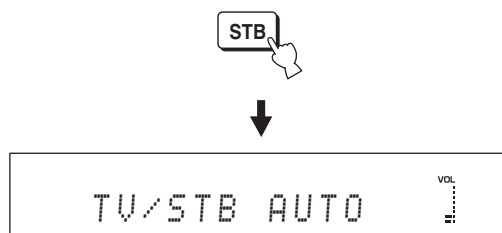

Press DVD to play back a DVD.

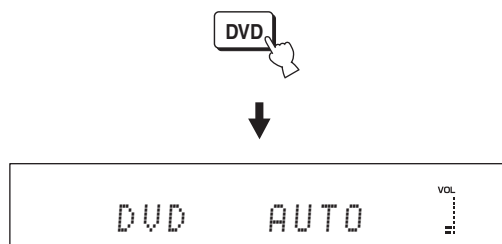

Press **VCR** to play back a component connected to the VCR input jack on the rear panel of this unit.

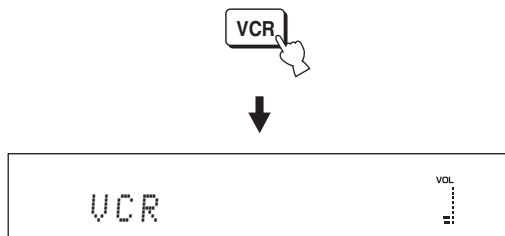

Press **AUX** to play back a component connected to the AUX jack on the rear panel of this unit.

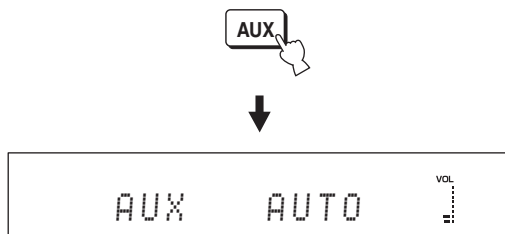

Playing back sources

Once an input source is selected (see page 41), you can play back the selected input source.

Note

This section uses a DVD player as an example of the playback source.



For details on your TV and DVD player, refer to the respective owner's manual.

- 2 Switch to the video input on your TV using the remote control supplied with the TV and display the DVD menu screen.

Note

If necessary, turn down the volume of your TV until no sound is heard.

- 3 Press **DVD** to select DVD as the input source.



- 4 Play back DVD on your DVD player using the supplied remote control.

Audio signals from your DVD player are output from this unit.



- You can use the supplied demonstration DVD to check the digital signals being input at the DVD player with the digital connection (optical/coaxial). The **MULTI** indicator lights up when this unit detects the 5.1-channel signal input at the optical/coaxial jack. If the **PCM** indicator lights up, confirm the settings of the digital output, bitstream output, and/or DTS output of the DVD player.
- If the output volume is too low, increase the volume of this unit to around 45.
- If you have set the appropriate remote control codes for your TV and DVD player, you can use the remote control supplied with this unit to operate these components. For details on how to set remote control codes, see page 79.

- 1 Turn on the power of your DVD player.

Adjusting the volume

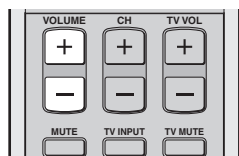
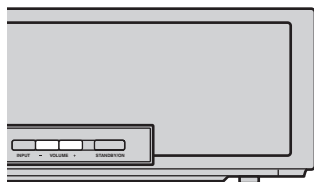

Press VOLUME +/- to increase or decrease the volume level.

The numeric value of the volume level appears in the front panel display.

Control range: MIN (minimum), 01 to 99, MAX (maximum)

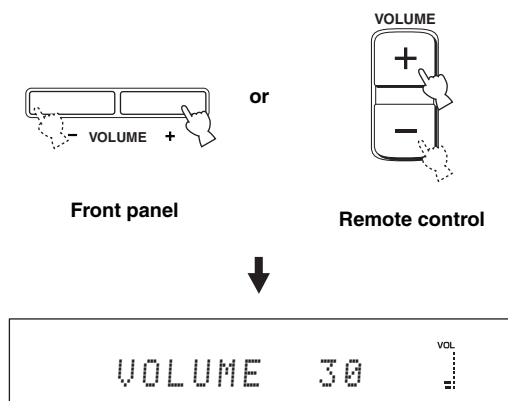

Notes

- The volume level of all input sources (including multi-channel as well as stereo sources) changes at the same time.
- One volume level increases or decreases each time you press VOLUME +/-.
- You can continuously increase or decrease the volume level if you press and hold VOLUME +/-.

Muting the sound

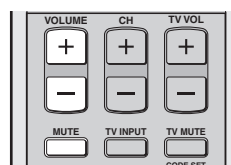

1 Press MUTE to mute the sound.

“AUDIO MUTE ON” appears in the front panel display, and the volume level indicator flashes.

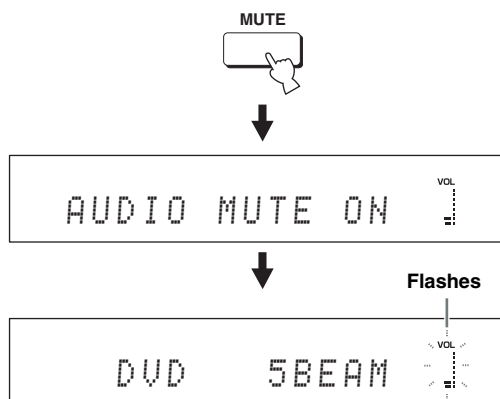

2 Press MUTE again (or press VOLUME +/-) to resume the sound output.

“AUDIO MUTE OFF” appears temporarily in the front panel display (or the numeric value of the current volume level appears if you press VOLUME +/-), and the volume level indicator lights up.

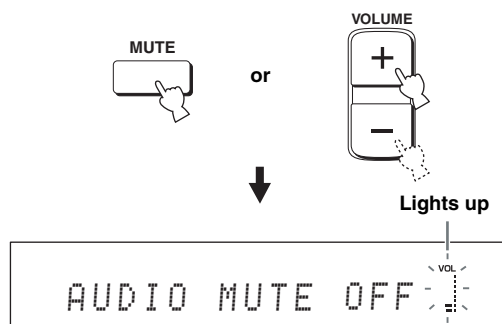

Note

The sound output of all input sources (including multi-channel as well as stereo sources) is muted at the same time.



You can select whether the sound output is to be muted completely or by 20 dB when you press MUTE (see page 62).

Enjoying surround sound

You can enjoy multi-channel surround sound by changing the beam mode using the beam mode buttons on the remote control. Select 5 Beam, Stereo plus 3 Beam, 3 Beam, or My Surround for multi-channel playback.

Notes

- When ANGLE TO WALL OR CORNER is set in MANUAL SETUP (see page 58), 5 Beam and 3 Beam cannot be selected.
- To enjoy 5 Beam, Stereo plus 3 Beam, or 3 Beam as the beam mode, you must perform AUTO SETUP or MANUAL SETUP so that the parameters best match your listening environment.

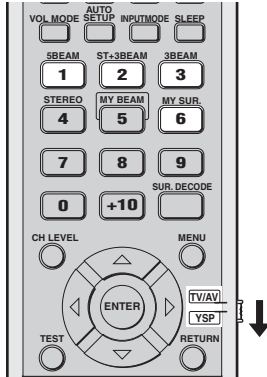

1 Set the operation mode selector to YSP.

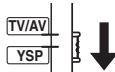

2 Press one of the beam mode buttons (5BEAM, ST+3BEAM, 3BEAM, or MY SUR.) to select the desired beam mode for 5.1-channel play back.

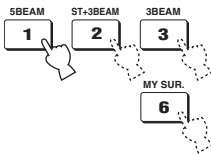

5 Beam

Outputs sound beams from the front left, front right, center, surround left, and surround right channels. This mode is ideal for enjoying surround sound effects to the fullest when you watch DVDs recorded in a multi-channel format or play back 2-channel sources in a multi-channel format.

Press 5BEAM to select 5 Beam.

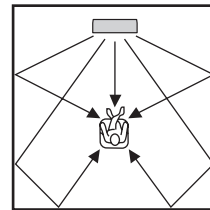

Notes

- To achieve the best surround sound effect, make sure that there are no obstacles placed in the path of sound beams in that the objects may prevent the sound beams from rebounding directly off the walls in your listening room.
- The front left and right sound beams are output toward the walls in your listening room.
- “SP Pos. Corner!” appears in the front panel display if INSTALLED POSITION is set to ANGLE TO WALL OR CORNER (see page 58).

Stereo plus 3 Beam

Outputs normal sound from the front left and right channels and sound beams from the center and surround left and right channels. This mode is ideal for watching live recordings on a DVD. Vocals and instrumental sounds can be heard close to the center of the listening position while sound reflections from the venue itself can be heard on your right and left, giving you the feeling that you are sitting right in front of the stage.

Press ST+3BEAM to select Stereo plus 3 Beam.

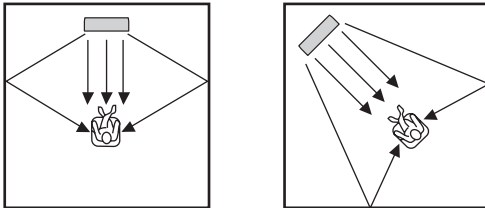

Note

The front left and right sound beams are output directly toward the listening position.

3 Beam

Outputs sound beams from the front left and right and center channels. This mode is ideal for enjoying movies with the whole family. Because the listening position area is widened, you can enjoy excellent quality surround sound over a wider area. In addition, you can use this mode when the listening position is close to the backside of the wall, and the surround left and right sound beams cannot be reflected off the wall.

Press 3BEAM to select 3 Beam.

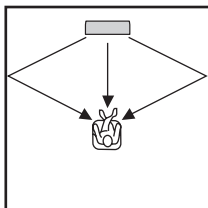

You can achieve a more realistic surround effect if you adjust settings for IMAGE LOCATION in BEAM MENU (see page 61).

Notes

- When you play back multi-channel sources, surround left and right signals are mixed down and output from the front left and right channels.
- The front left and right sound beams are output toward the walls in your listening room.
- “SP Pos. Corner!” appears in the front panel display if INSTALLED POSITION is set to ANGLE TO WALL OR CORNER (see page 58).

My Surround

This mode enables surround system in a small listening area which may not fulfill the listening room conditions for other beam modes (see “Before installing this unit” on page 13). Use this beam mode when you want to enjoy surround sound near this unit, or when the other beam modes are unavailable.

Press MY SUR. to select My Surround.

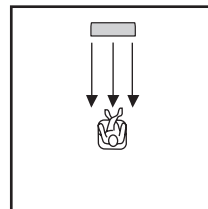

Notes

- Beam mode settings such as beam angles and distances are ineffective in this mode.
- For the full effect of My Surround, your listening position must face toward the front of this unit.

■ Decoder indicators

Depending on the input source and the selected surround mode, the decoder indicators in the front panel display light up as follows:

Status	Indicator
When PCM signals are being input	PCM
When DTS digital signals are being input or DTS Neo:6 is selected as the surround mode	dts
When Dolby Digital signals are being input	DIGITAL
When Dolby Pro Logic is selected as the surround mode	PL
When Dolby Pro Logic II is selected as the surround mode	PL II



- You can select an input mode (AUTO, DTS, or ANALOG) by pressing INPUTMODE repeatedly (see page 70).
- Discs encoded in DTS-ES, Dolby Digital 5.1 EX, Dolby Digital EX, or Dolby Digital Surround EX will be played back in DTS or Dolby Digital.

■ Surround modes and recommended sources

Surround mode		Recommended source
DTS Neo:6	Cinema Music	Movies Music
Dolby Pro Logic	–	All sources
Dolby Pro Logic II	Movie Music Game	Movies Music Games

Notes

- When you select an input source (see page 41), the surround mode used for the previously selected input source is automatically selected.
- If the power of this unit is turned off and on again, the surround mode used for the previously selected input source before the power was turned off is automatically selected.
- If the surround modes are not available, “Prohibit” appears in the front panel display when you press SUR. DECODE.
- The surround modes are available:
 - when the beam mode is set to a setting other than the stereo playback (see page 50), My Beam (see page 51), and My Surround (see page 45).
 - when 2-channel signals are being input.

Enjoying 2-channel sources in surround sound

This unit can decode 2-channel sources for 5.1-channel playback so that you can enjoy a variety of surround sound effects by switching the surround mode.



The beam mode must be set to 5 Beam, Stereo plus 3 Beam, or 3 Beam (see page 44).

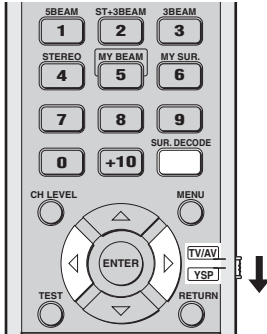

1 Set the operation mode selector to YSP.

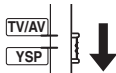

2 Press SUR. DECODE repeatedly (or press SUR. DECODE and then press $\triangle / \triangleright$) to switch between surround modes.

Choices: Neo:6 Cinema, Neo:6 Music, PRO LOGIC, PLII Movie, PLII Music, PLII Game

Default setting: Neo:6 Cinema

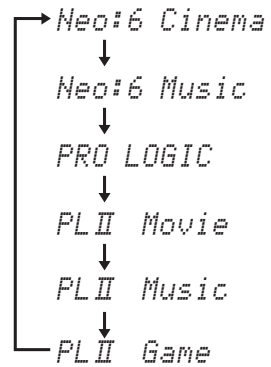
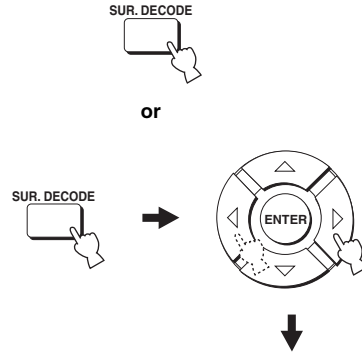

Enjoying TV in surround sound

You can enjoy analog audio signals output from your TV in real surround sound.



Before performing the steps below, set the volume of this unit to 30. If necessary, adjust the volume level in step 4 below.

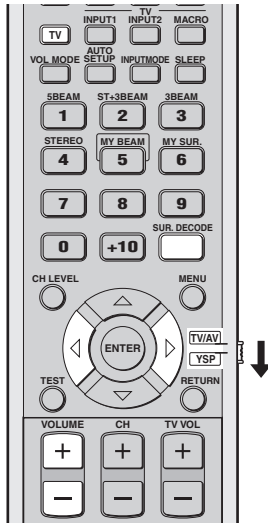

1 Select the TV channel you want to watch.

To select a TV channel, use the remote control supplied with your TV.

2 Set the operation mode selector to YSP.

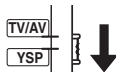

3 Press TV.

This unit outputs audio signals from your TV.



4 If you hear sound from your TV speakers, reduce the volume level of your TV until you can no longer hear any audio being output.

To reduce the TV volume level, use the remote control supplied with your TV.

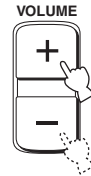

5 Press VOLUME +/- to adjust the volume level.

6 Press SUR. DECODE repeatedly (or press SUR. DECODE and then press < / >) to switch between surround modes.

Signals input from 2-channel sources are played back in multi-channels.

For more information on surround modes, see page 46.



or

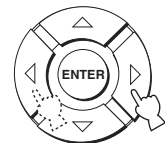

Adjusting surround mode parameters

You can configure the parameters for Dolby Pro Logic II Music and DTS Neo:6 Music to fine-tune the surround sound effect.

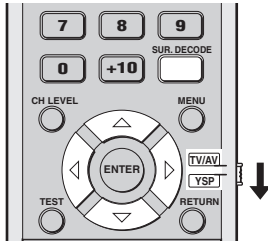

1 Repeat steps 1 and 2 in “Enjoying 2-channel sources in surround sound” on page 47 and select PL II Music or Neo:6 Music.

2 Press \triangle / ∇ to select the parameter.

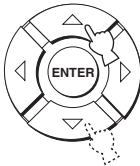

3 Press $\triangleleft / \triangleright$ to configure the selected parameter.

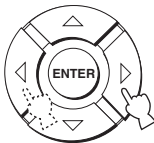

■ When Dolby Pro Logic II Music is selected

PANORAMA

Gives the front left and right channel sound a wraparound effect, distributed throughout the entire surround sound field to give you an expansive feeling.
 Choices: ON/OFF
 Default setting: OFF

DIMENSION

Adjusts the difference in volume between the front and surround channels to the desired volume balance.
 Control range: -3 (toward the surround direction) to +3 (toward the front direction)
 Default setting: STD (standard)

C. WIDTH

Distributes the center channel sound to the left and right. If 0 is selected, the center channel sound is output only from the center channel.
 Control range: 0 to 7
 Default setting: 3

■ When DTS Neo:6 Music is selected

C. IMAGE

Adjusts the center image from three channels (front left and right and center) to varying degrees.
 Control range: 0.0 (wider) to 1.0 (toward the center)
 Default setting: 0.3

Enjoying stereo sound

You can enjoy 2-channel stereo playback as the beam modes by pressing STEREO on the remote control. Sounds are output from the front right and left channels. This is ideal for playing back hi-fi sources, such as CDs, and can be used to replace your TV speakers.

Notes

- When you play back Dolby Digital audio signals in the stereo playback, the dynamic range becomes compressed. If the volume level decreases to the extreme, use other beam modes except My Beam.
- When the stereo playback is selected as the beam mode, the surround modes (see page 46) become ineffective.

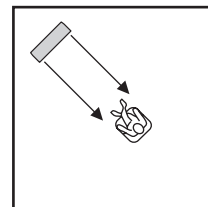
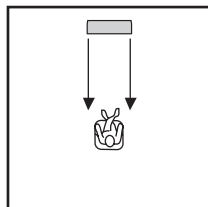
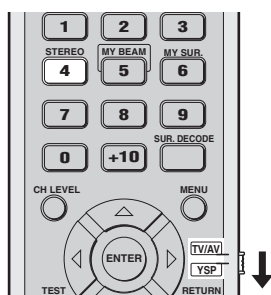

1 Set the operation mode selector to YSP.

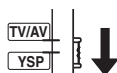

Note

When you play back multi-channel sources, all signals except those from the front left and right channels are mixed down and output from the front left and right channels. No audio is output from the center and surround channels.

2 Press STEREO to select the stereo playback as the beam mode.

“STEREO” appears in the front panel display.

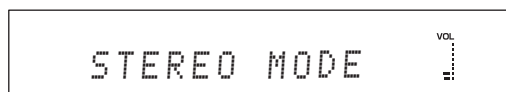

Playing back sound clearly (My Beam)

You can improve listenability in a noisy environment by changing the beam mode to My Beam, which outputs sound beams directly toward the listening position in a single channel. In addition, My Beam is also ideal when you do not want the sound beams to be reflected on the walls in your listening room or when you do not want to disturb other people while enjoying music or movies at night.

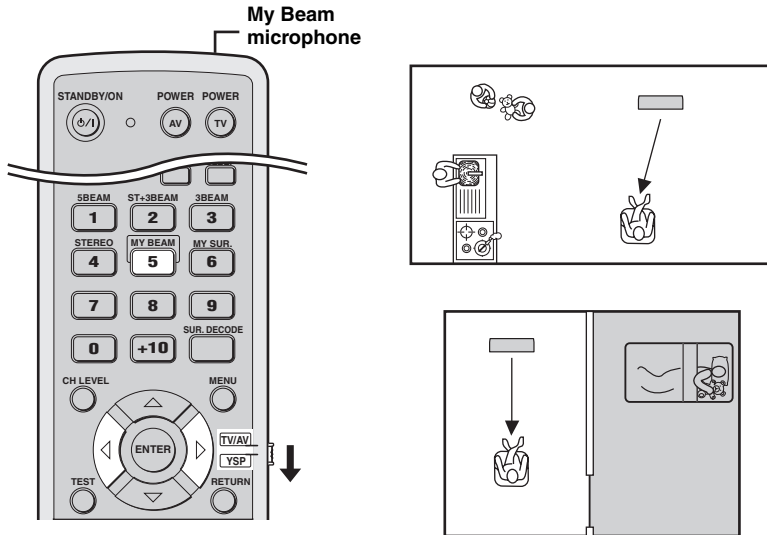

Note

If My Beam is selected as the beam mode, the surround modes (see page 46) and TruBass (see page 63) become ineffective. In addition, no audio is output from the subwoofer connected to this unit.

Using auto-adjust function

The My Beam microphone on the remote control collects the test tones from this unit so that the beam angle can be automatically adjusted.

1 Set the operation mode selector to YSP.

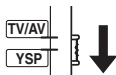

2 Press and hold MY BEAM for more than two seconds.

A test tone is output twice from this unit. Keep pointing the remote control toward this unit while the test tones are being output so that the My Beam microphone can collect the test tones.

Control range: L50° to R50°

Operation guarantee range: 6 m (20 ft), L30° to R30°



Notes

- If an error occurs, an error buzzer is played and "MY BEAM ERROR" is displayed in the front panel display.
- An error may occur if the listening room is noisy. Make sure that the listening room is as quiet as possible while the test tones are being output.
- Do not shake or move the remote control while the test tones are being output.
- Do not cover the My Beam microphone on the remote control while the test tones are being output.
- The batteries in the remote control may be weak if the remote control does not function properly. In this case, replace all the batteries and then try the procedure again.
- When the input signal with 64 kHz, 88.2kHz, or 96 kHz of sampling frequency is being played back, the beam angle cannot be automatically adjusted.

Using manual-adjust function

You can adjust the beam angle manually while playing back an input source. This function is also ideal if the listening position is out of the operation guarantee range of the auto-adjust function.

1 Set the operation mode selector to YSP.

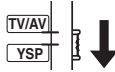

2 Press MY BEAM.

“MY BEAM” is displayed in the front panel display.



3 Press ◀ / ▶ while “MY BEAM” is displayed to adjust the beam angle.

Control range: L90° to R90°

- Press ◀ repeatedly to increase the horizontal angle on the left side.
- Press ▶ repeatedly to increase the horizontal angle on the right side.

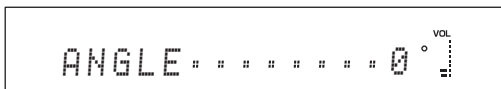
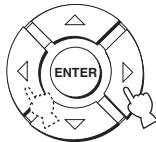

4 Press MY BEAM again to complete the beam angle adjustment.

Using the volume mode (Night listening enhancer/TV volume equal mode)

The night listening enhancers are designed to improve listenability at lower volumes or at night. In addition, you can limit the volume level of the TV so that it will not vary suddenly to a great extent whenever the contents being broadcast change (i.e. due to commercials, etc.).

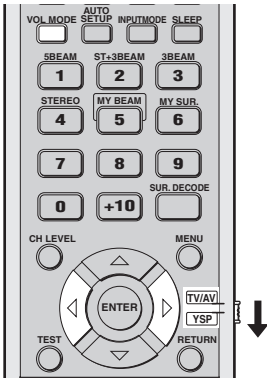

1 Set the operation mode selector to YSP.

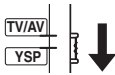

2 Press VOL MODE repeatedly to select NIGHT:CINEMA, NIGHT:MUSIC, TV EQUAL VOLUME, or OFF.

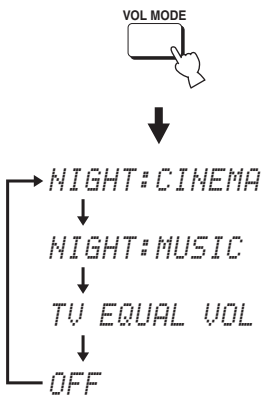

The NIGHT indicator lights up in the front panel display when “NIGHT:CINEMA” or “NIGHT:MUSIC” is selected.

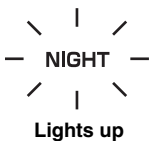

The EQUAL indicator lights up in the front panel display when “TV EQUAL VOLUME” is selected.

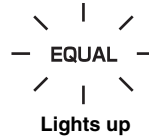

- Select NIGHT:CINEMA when watching films to reduce the dynamic range of film soundtracks and to make dialog easier to hear at lower volumes.
- Select NIGHT:MUSIC when listening to music sources to preserve ease-of-listening for all sounds.
- Select TV EQUAL VOLUME when watching TV programs.
- Select OFF to turn off the volume mode.

3 Press ◀/▶ to adjust the effect level of compression while NIGHT:CINEMA, NIGHT:MUSIC, or TV EQUAL VOLUME is displayed.

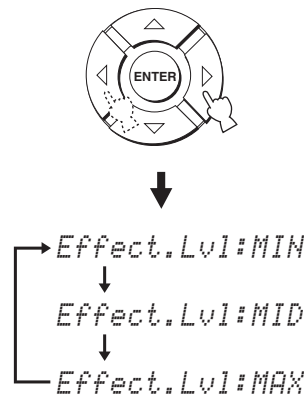

- Select Effect.Lvl:MIN for minimum compression.
- Select Effect.Lvl:MID for standard compression.
- Select Effect.Lvl:MAX for maximum compression.

Notes

- The volume mode settings are canceled if you press STANDBY/ON or disconnect the AC power supply cable from the AC wall outlet.
- The volume mode settings become ineffective when My Surround is selected as the beam mode (see page 45).

Using the sleep timer

Use this feature to automatically set this unit to the standby mode after a specified period of time. The sleep timer is useful if you are going to sleep after a certain amount of time while this unit is still playing back a source.



Each time you press SLEEP, the front panel display changes as shown below.

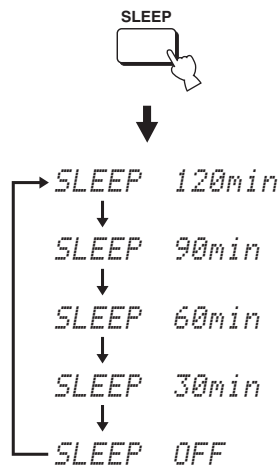

1 Set the operation mode selector to YSP.

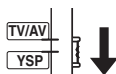

2 Press SLEEP repeatedly to set the interval for the sleep timer.

Choices: 120min, 90min, 60min, 30min, OFF
The SLEEP indicator flashes in the front panel display while switching the interval for the sleep timer.



3 Wait for a few seconds without operating this unit to confirm the setting for the sleep timer.

The SLEEP indicator lights up in the front panel display, indicating that the sleep timer is activated.

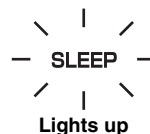

■ Canceling the sleep timer

1 Set the operation mode selector to YSP.

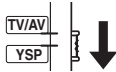

2 Press SLEEP repeatedly until “SLEEP OFF” appears in the front panel display.

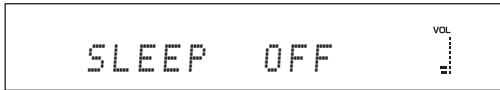

3 Wait for a few seconds without operating this unit to confirm the setting for the sleep timer.

The SLEEP indicator disappears from the front panel display, indicating that the sleep timer is deactivated.

SLEEP
Disappears

Note

The previous setting for the sleep timer before you deactivate it is stored in the system memory.



The sleep timer setting can also be deactivated if you press STANDBY/ON to set this unit to the standby mode or unplug the AC power supply cable from the AC outlet.

MANUAL SETUP

To achieve the best quality surround sound, you can use MANUAL SETUP to fine-tune the listening environment parameters, as well as to make advanced settings for sound signals, sound beams, digital input, and the OSD. Change the initial settings (indicated in bold under each parameter) to reflect the needs of your own listening environment.



- You can save the settings optimized by the AUTO SETUP procedure (see page 38). A set of settings optimized according to the specific conditions of your listening environment can be recalled later depending on the varying conditions of your listening environment (see page 39).
- Most of the parameters in SOUND MENU and BEAM MENU are automatically set when you run AUTO SETUP (see page 31). Use SOUND MENU and BEAM MENU to make additional adjustments.
- BEAM MENU allows you to make settings for the surround sound effects normally available in the speaker settings menu.
- Make settings for the parameters in BEAM MENU first before making settings for the parameters in SOUND MENU, INPUT MENU, and DISPLAY MENU.

SOUND MENU

Use to manually adjust the various parameters related to the sound output.

Item	Features	Page
TONE CONTROL	Adjusts the output level of high-frequency or low-frequency sound.	62
SUBWOOFER SET	Adjusts the various subwoofer settings.	62
MUTE LEVEL	Adjusts the muting level.	62
AUDIO DELAY	Adjusts the audio delay.	63
DD/DTS Dynamic Range	Adjusts the dynamic range of Dolby Digital or DTS signals.	63
TruBass	Selects the bass sound enhancer.	63

BEAM MENU

Use to manually adjust the various parameters related to the sound beam output.

Item	Features	Page
SETTING PARAMETERS	Adjusts the listening room and listening position settings.	58
BEAM ADJUSTMENT	Adjusts the various sound beam settings.	59
IMAGE LOCATION	Adjusts the sound position of the front left and right channels.	61

INPUT MENU

Use to manually adjust the various parameters related to the audio and video input.

Item	Features	Page
INPUT MODE	Selects the initial input of the source.	64
INPUT TRIM	Adjusts the input level of the source.	64
INPUT RENAME	Renames the displayed input source.	65

DISPLAY MENU

Use to manually adjust the various parameters related to the display.

Item	Features	Page
F.DISPLAY SET	Adjusts the front panel display settings.	66
OSD SET	Adjusts the OSD settings.	66
UNIT SET	Changes the display unit of measurement.	66

Using MANUAL SETUP

Use the remote control to access and adjust each parameter.

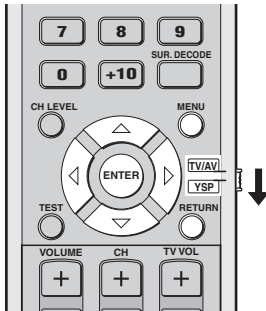

You can adjust the SET MENU parameters while the unit is reproducing sound.

1 Set the operation mode selector to YSP.

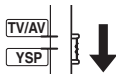

2 Press MENU.

The SET MENU screen appears on your TV.



- The control buttons used for SET MENU are displayed at the bottom of the screen.
- To return to the previous screen while using SET MENU, press RETURN.
- To exit from the SET MENU screen, press MENU once more.
- You can also perform the following operations in the front panel display.

3 Press Δ / ∇ to select MANUAL SETUP and press ENTER.

The following screen appears on your TV.

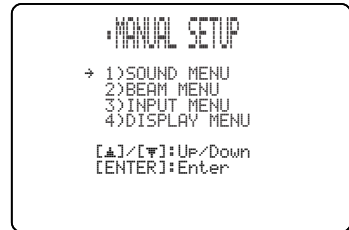
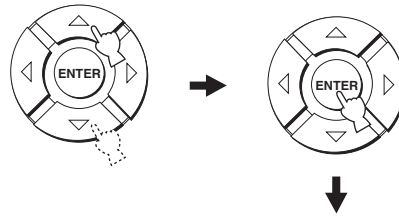

4 Press Δ / ∇ to select a sub menu and press ENTER.

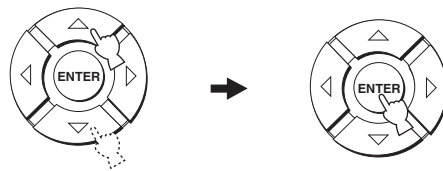

5 Press Δ / ∇ / \leftarrow / \rightarrow and ENTER to configure each parameter.

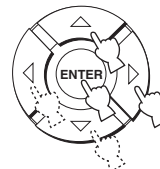

6 Press MENU to exit.

The OSD disappears from your TV screen.



BEAM MENU

Use to manually adjust the various parameters related to the sound beam output.

SET MENU → MANUAL SETUP → BEAM MENU

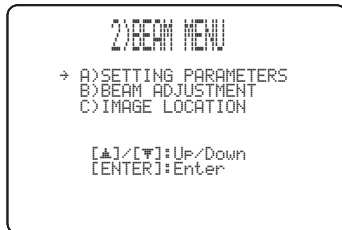

You can adjust the sound beam output level of each channel in “Adjusting the audio balance” (see page 67).

SETTING PARAMETERS (Setting parameters)

Use to set the position of this unit in your listening room and the distance of this unit from the listening position. When you make settings for each parameter, other related parameters are automatically adjusted to best match your listening environment.

Note

If you make adjustments in SETTING PARAMETERS, the beam optimization settings made in the AUTO SETUP procedure will be lost. If you want to keep the beam optimization settings made in the AUTO SETUP and make further adjustments, adjust settings in BEAM ADJUSTMENT first (see page 59).



INSTALLED POSITION (Installed position of this unit)

Use to adjust the installed position of this unit.

Choices: **FLAT TO WALL** (Parallel to wall installation), **ANGLE TO WALL OR CORNER** (Corner installation)

FLAT TO WALL

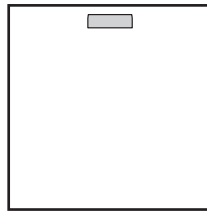

ANGLE TO WALL OR CORNER

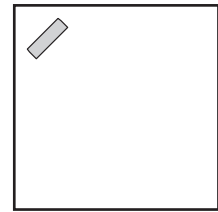

- Select **FLAT TO WALL** if this unit is installed in parallel with the wall in your listening room. Adjust the width and length of your listening room as well as the distance of the listening position from this unit and the distance of the center of this unit from the left wall.

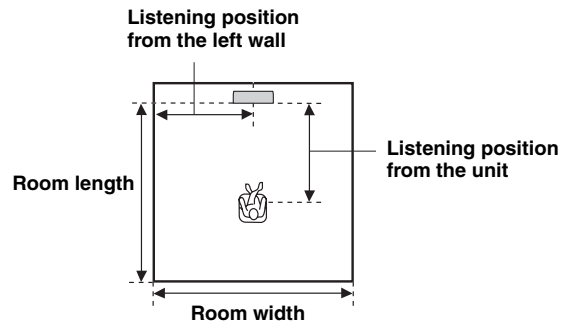

Choices for the room width and length:

2.0 m to 12.0 m (6.5 ft to 40.0 ft)

Choices for the listening position from this unit:

1.8 m to 9.0 m (6.0 ft to 30.0 ft)

Choices for the listening position from the left wall:

0.6 m to 11.4 m (2.0 ft to 38.0 ft)

Room width and length

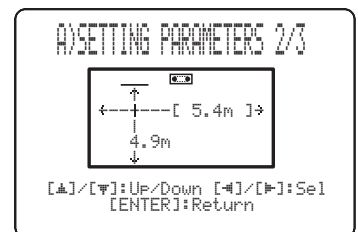

Listening position from the unit and the left wall

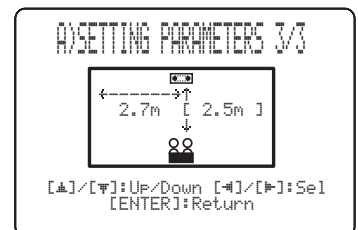

- Select ANGLE TO WALL OR CORNER if this unit is installed in the corner of your listening room. Adjust the width and length of your listening room as well as the distance of the listening position from this unit.

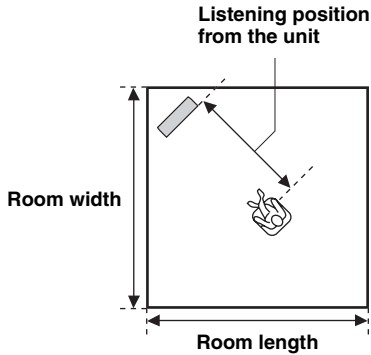

Choices for the room width and length:
2.0 m to 12.0 m (6.5 ft to 40.0 ft)
Choices for the listening position from this unit:
1.8 m to 9.0 m (6.0 ft to 30.0 ft)

Room width and length

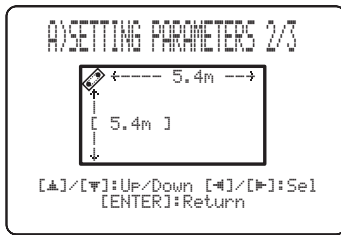

Listening position from the unit

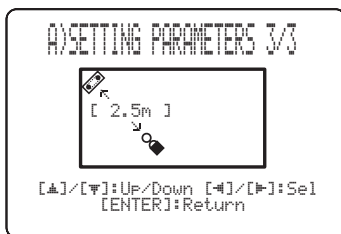

Note

When you set the INSTALLED POSITION parameter in MANUAL SETUP (see page 58), the parameters newly set for the width and length of your listening room are automatically set as the factory default value.

BEAM ADJUSTMENT (Beam adjustment)

Use to manually adjust the various sound beam settings. We recommend that you select 5 Beam as the beam mode before adjusting these parameters (see page 44).

Notes

- When INSTALLED POSITION is adjusted in MANUAL SETUP (see page 58), the factory default value is automatically set for this parameter except Center in FOCAL LENGTH (see page 60).
- Depending on the beam mode settings (see pages 44 and 50), some channel positions may not be available for selection. In this case, “--” is displayed. When using Stereo plus 3 Beam as the beam mode, set the surround left and right signals to be output from the front left and right channels.

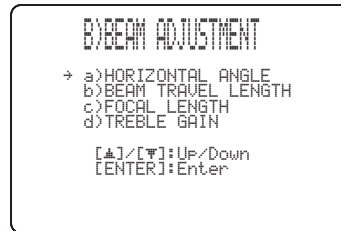

HORIZONTAL ANGLE (Horizontal angle)

Use to adjust the horizontal angle of sound beams for each channel. By adjusting the horizontal angle of the sound beams, you can optimize the sound beam paths. A test tone is automatically output.

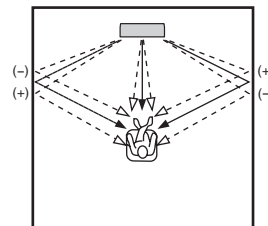

Choices: L90° to R90°

Adjust toward L (left) to move the direction of the output to the left and adjust toward R (right) to move it to the right.

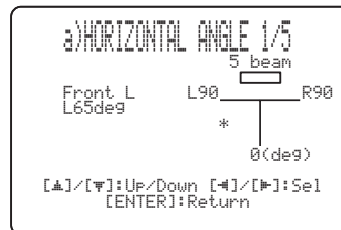

BEAM TRAVEL LENGTH (Beam travel length)

A certain amount of delay must be applied to the sound from each channel so that all sounds can arrive at the listening position at the same time. This menu sets the distance that sound beams travel after being output and reflected off the wall until they arrive at the listening position and adjusts the delay applied to the respective channel.

The lines in the illustration below indicate the distance.

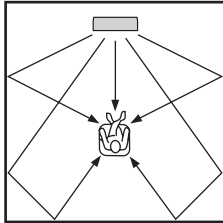

Choices: 0.3 m to 24.0 m (1.0 ft to 80.0 ft)

- **Front L** adjusts the distance the front left channel sound beams travel.
- **Front R** adjusts the distance the front right channel sound beams travel.
- **Center** adjusts the distance the center channel sound beams travel.
- **Surround L** adjusts the distance the surround left channel sound beams travel.
- **Surround R** adjusts the distance the surround right channel sound beams travel.

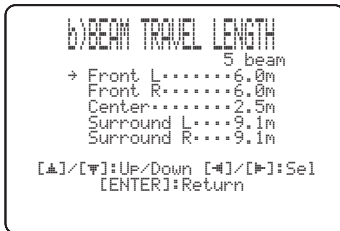

We recommend that you use the setting optimized by AUTO SETUP (see page 31). Adjust this parameter only when you changed HORIZONTAL ANGLE (see page 59).

FOCAL LENGTH (Focal length)

Use to set the distance from the front of this unit to the focal point of output for each channel to achieve an expansive feeling for each channel.

The focal points except for the center channel should be set near the reflection points on the walls. The shorter the distance, the larger the expansion.

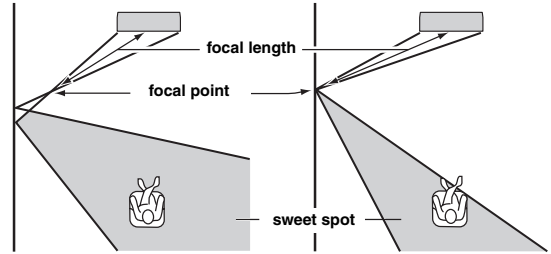

Front left channel

Center channel

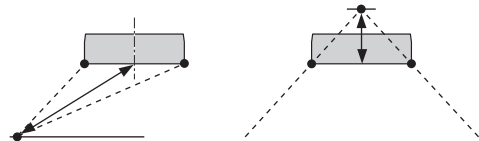

Choices: -1.0 m to +13.0 m (-3.5 ft to +43.5 ft)

Adjust toward - (minus) to move the focus outward and adjust toward + (plus) to move the focus toward the normal position.

- **Front L** adjusts the focal length for the front left sound beams.
- **Front R** adjusts the focal length for the front right sound beams.
- **Center** adjusts the focal length for the center sound beams. Initial setting: -0.3 m (-1.0 ft)
- **Surround L** adjusts the focal length for the surround left sound beams.
- **Surround R** adjusts the focal length for the surround right sound beams.



We recommend that you use the initial setting (-0.3 m (or -1.0 ft) for the center channel.

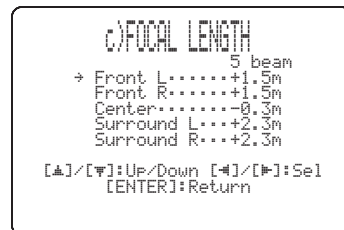

TREBLE GAIN (Treble gain)

Use to adjust the high-frequency output level of each channel.



If the reflection points of the front left and right or surround left and right sound beams are on curtain or other acoustically absorbent surfaces, you can achieve more effective surround sound by increasing the treble level for those sound beams.

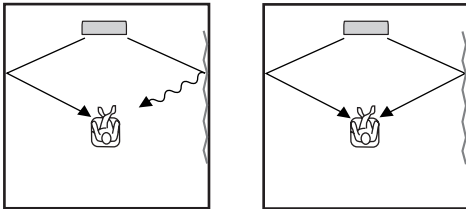

Choices: -12.0 dB to +12.0 dB

Initial setting: 0 dB

- **Front L** adjusts the high-frequency output level of the front left channel.
- **Front R** adjusts the high-frequency output level of the front right channel.
- **Center** adjusts the high-frequency output level of the center channel.
- **Surround L** adjusts the high-frequency output level of the surround left channel.
- **Surround R** adjusts the high-frequency output level of the surround right channel.

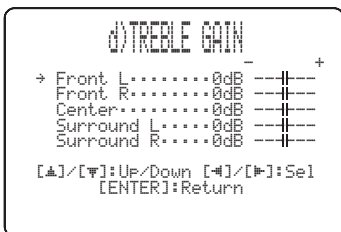

IMAGE LOCATION (Image location)

Use to adjust the direction from which the front left and right channel sound is heard so that each sound can be heard closer to the center channel.

Use this feature to redirect audio signals if the sound coming from the front left and right channels seems unnatural, such as when your listening position is not the center of your listening room.

You can only adjust this parameter when 3 Beam or 5 Beam is selected as the beam mode (see page 44).

Choices: ON, OFF

Setting range: 0% to 95%

Initial setting: 0%

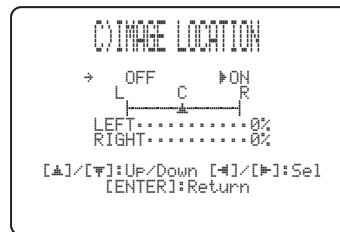

LEFT (Left)

Adjusts audio signals toward the left.

The higher the percentage, the louder the output from the center.

Without adjustment

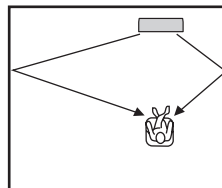

With the front left channel adjusted

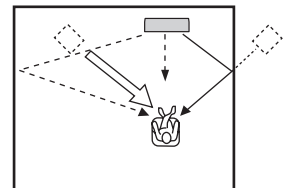

RIGHT (Right)

Adjusts audio signals toward the right.

The higher the percentage, the louder the output from the center.

Without adjustment

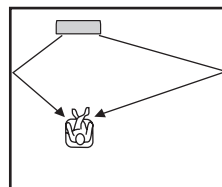

With the front right channel adjusted

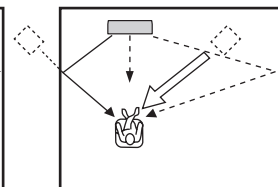

SOUND MENU

Use to manually adjust the various parameters related to the sound output.

SET MENU → MANUAL SETUP → SOUND MENU

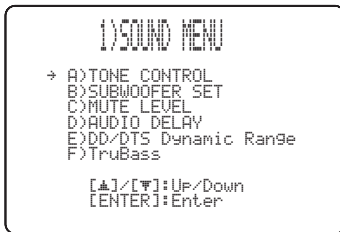

■ TONE CONTROL (Tone control)

You can adjust the tonal quality of sound beams.

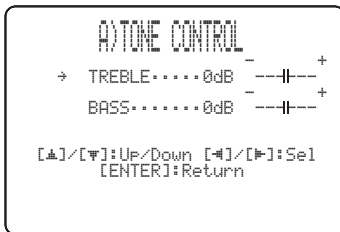

TREBLE (Treble)

Use to adjust the high-frequency response.

Choices: -12 dB to +12 dB

Initial setting: 0 dB

BASS (Bass)

Use to adjust the low-frequency response.

Choices: -12 dB to +12 dB

Initial setting: 0 dB

■ SUBWOOFER SET (Subwoofer settings)

Use to manually adjust the various subwoofer settings.

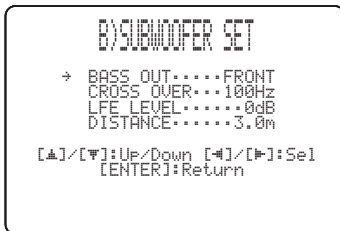

BASS OUT (Bass out)

Low-frequency (bass) signals can be directed to the subwoofer and/or the front left and right channels. This setting also determines the routing of LFE (low-frequency effect) signals found in Dolby Digital or DTS sources.

Choices: SWFR (Subwoofer), **FRONT**

- Select SWFR if you connect a subwoofer. LFE and low-frequency signals from other channels are directed to the subwoofer.
- Select FRONT if you do not use a subwoofer. LFE and low-frequency signals from other channels are directed to the front left and right channels.

CROSS OVER (Crossover)

When BASS OUT is set to SWFR, you can use this feature to select a crossover (cutoff) frequency for all low-frequency signals. All frequencies below the selected frequency will be sent to the subwoofer position.

Choices: 100Hz, **120Hz**, 150Hz

LFE LEVEL (Low-frequency effect level)

Select to adjust the output level of the LFE (low-frequency effect) channel according to the capacity of your subwoofer. The LFE channel carries low-frequency special effects which are only added to certain scenes. This setting is effective only when this unit decodes Dolby Digital or DTS signals.

Choices: -20 to **0** dB

DISTANCE (Distance)

Select to adjust the distance of the subwoofer from the listening position.

Choices: 0.3 to 15.0 m (1.0 ft to 50.0 ft)

Initial setting: 3.0 m (10.0 ft)

■ MUTE LEVEL (Muting level)

Use to adjust how much the mute function reduces the volume level.

Choices: **MUTE**, -20 dB

- Select MUTE to completely halt all sound output.
- Select -20 dB to reduce the current volume level by 20 dB.



■ AUDIO DELAY (Audio delay)

Use to delay the sound output and synchronize it with the video image. This may be necessary when using certain LCD monitors or projectors.

Choices: **0** to 160 msec



■ DD/DTS Dynamic Range (Dynamic range of Dolby Digital and DTS signals)

Use to select the amount of dynamic range compression. This setting is effective only when the unit is decoding Dolby Digital and DTS signals. Dynamic range is the difference between the smallest sound that can be heard above the noise of the equipment and the biggest sound that can be heard without distortion.

Choices: MIN (minimum), STD (standard), **MAX** (maximum)

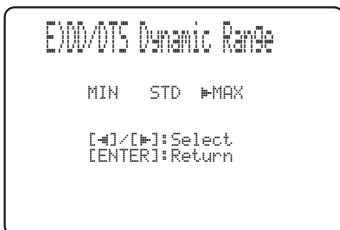

Select to adjust the dynamic range compression.

- Select MIN for listening to sources at low volume levels.
- Select STD for general use.
- Select MAX for feature films.

■ TruBass

Use to turn on or off the bass sound enhancer. The SRS TruBass technology improves bass even without a subwoofer and provides deeper, richer bass in the presence of a subwoofer.

Choices: OFF, **ON**



Note

TruBass is not available when My Beam (see page 51) or My Surround (see page 45) is selected as the beam mode.

INPUT MENU

Use to manually adjust the various parameters related to the audio and video input.

SET MENU → MANUAL SETUP → INPUT MENU



■ INPUT MODE (Input mode)

Use to designate the input mode for the input sources connected to the DIGITAL INPUT jacks when you turn on the power of this unit. For information on the types of audio signals that can be output by this unit, see “Selecting the input mode” on page 70.

Choices: **AUTO**, **LAST**



- Select **AUTO** to set this unit to automatically detect the type of input signals and select the appropriate input mode.
- Select **LAST** to set this unit to automatically select the last input mode used for that input source. If the type of input signals is different from the setting, no sounds will be produced.

■ INPUT TRIM (Input trim)

Use to adjust the input level of the input source.

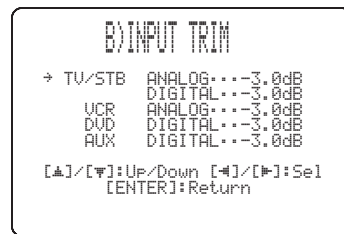

- Select **TV/STB ANALOG** to adjust the level of audio and video signals input at the TV/STB AUDIO INPUT jacks of this unit.
Control range: -6.0 dB to 0.0 dB
Initial setting: -3.0 dB
- Select **TV/STB DIGITAL** to adjust the level of audio and video signals input at the TV/STB OPTICAL DIGITAL INPUT jack of this unit.
Control range: -6.0 dB to 0.0 dB
Initial setting: -3.0 dB
- Select **VCR ANALOG** to adjust the level of audio and video signals input at the VCR AUDIO INPUT jacks of this unit.
Control range: -6.0 dB to 0.0 dB
Initial setting: -3.0 dB
- Select **DVD DIGITAL** to adjust the level of audio and video signals input at the DVD COAXIAL DIGITAL INPUT jack of this unit.
Control range: -6.0 dB to 0.0 dB
Initial setting: -3.0 dB
- Select **AUX DIGITAL** to adjust the level of audio and video signals input at the AUX OPTICAL DIGITAL INPUT jack of this unit.
Control range: -6.0 dB to 0.0 dB
Initial setting: -3.0 dB

■ INPUT RENAME (Input rename)

Use to change the name of the input source in the OSD and the front panel display. Press an input selector button (e.g., DVD) to select the component you want to change the name for and perform the following procedure.



1 Press ◀/▶ to place the _ (underscore) under the space or the character you want to edit.

The _ (underscore) flashes.

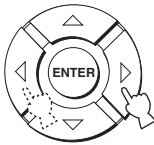

2 Press ▲/▼ to select the desired character.

- You can use up to 8 characters for each input.
- Press ▼ to change the character in the following order or press ▲ to go in the reverse order:
A to Z, a space, 0 to 9, a space, a to z, a space, #, *, +, etc.

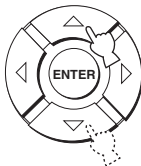

3 Repeat steps 1 to 2 to rename each input.

4 Press ENTER to exit.

The new names are registered, and the display returns to the previous screen.

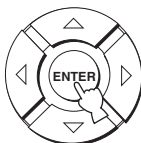

DISPLAY MENU

Use to manually adjust the various parameters related to the display.

SET MENU → MANUAL SETUP → DISPLAY MENU



■ F.DISPLAY SET (Front panel display settings)

Use to adjust the brightness and display settings of the front panel display.

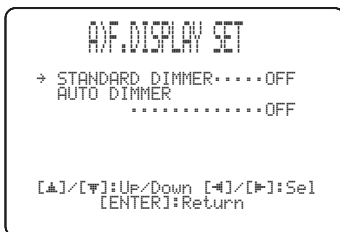

STANDARD DIMMER (Standard dimmer)

Use to adjust the brightness of the front panel display when you operate this unit by using the control buttons on the front panel or on the remote control.

Choices: -2, -1, **OFF**

AUTO DIMMER (Auto dimmer)

If no operation is performed for a specified period of time, the front panel display dims. Use to adjust the brightness of the front panel display in this case.

Choices: **OFF** (the same brightness as the STANDARD DIMMER setting), -1 to -3 (based on the STANDARD DIMMER setting), DISPLAY OFF

■ OSD SET (OSD settings)

Use to adjust the display position and to set the display time of the OSD.



OSD SHIFT (OSD shift)

Use to adjust the vertical position of the OSD. Adjust toward the - (minus) direction to raise the position of the OSD, and adjust toward the + (plus) direction to lower it.

Choices: -5 to +5

Initial setting: 0

■ UNIT SET (Unit settings)

Use this to change the display unit of measurement.

Choices: **METERS**, FEET



- Select METERS to enter distances in meters.
- Select FEET to enter distances in feet.

Note

If you change this setting, the adjusted sound beam settings may change.

Adjusting the audio balance

You can adjust the sound beam output level of each channel by using the test tone or the audio output being played back in each beam mode to achieve a more true-to-life surround sound experience.

Using the test tone

You can use the test tone feature to output a test tone from each channel to manually balance the channel levels. Use this to set the channel levels so that the volume level of each channel is identical when heard from your listening position.

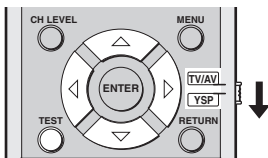

1 Set the operation mode selector to YSP.

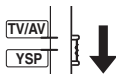

2 Press TEST.

“TEST LEFT” appears in the front panel display and a test tone is output from the front left channel.



3 Press \triangle / ∇ to select the channel you want to adjust.

The front panel display changes as follows:

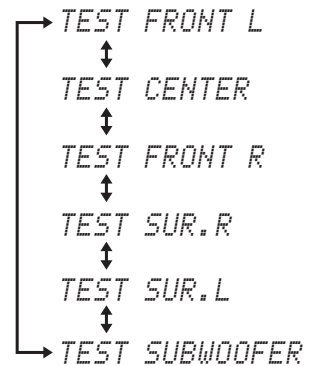

Note

“TEST SUBWOOFER” is only available when a subwoofer is connected to this unit and SWFR is selected for BASS OUT in SOUND MENU (see page 62).

4 Press \triangleleft / \triangleright to adjust the channel volume.

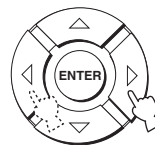

Control range: -10.0 dB to +10.0 dB

5 Press TEST when you have completed all your adjustments.



Notes

- All channel levels cannot be adjusted when the stereo playback (see page 50), My Beam (see page 51), or My Surround (see page 45) is selected as the beam mode.
- “FRONT L/R” cannot be adjusted when Stereo plus 3 Beam is selected as the beam mode (see page 45).
- “FRONT L/R” are automatically adjusted depending on the settings of the other channels when Stereo plus 3 Beam or stereo playback is selected as the beam mode (see pages 45 and 50).



If the level of a particular channel cannot be adjusted, “--dB” appears in the front panel display.

Using the audio output being played back

You can also manually adjust the channel levels while playing back an input source such as a DVD.

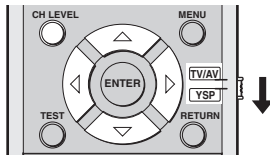

1 Set the operation mode selector to YSP.

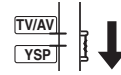

2 Press CH LEVEL repeatedly (or press CH LEVEL and \triangle / ∇) to select the channel you want to adjust.

The front panel display changes as follows.

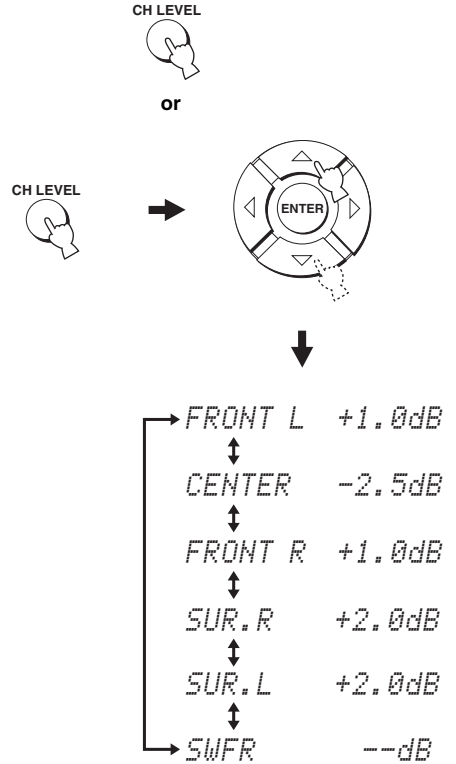

Note

“SWFR” is available only when a subwoofer is connected to this unit and SWFR is selected for BASS OUT in SOUND MENU (see page 62).

3 Press ◀/▶ to adjust the channel volume.

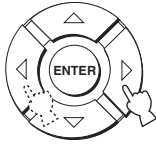

Control range: -10.0 dB to +10.0 dB

4 Wait for a few seconds without operating this unit when you have completed your adjustment.

Notes

- All channel levels cannot be adjusted when the stereo playback (see page 50), or My Surround (see page 45) is selected as the beam mode.
- “FRONT L/R” cannot be adjusted when Stereo plus 3 Beam is selected as the beam mode (see page 41).
- Only CENTER can be adjusted when My Beam is selected as the beam mode (see page 51).
- “FRONT L/R” are automatically adjusted depending on the settings of the other channels when Stereo plus 3 Beam or stereo playback is selected as the beam mode (see pages 45 and 50).



If the level of a particular channel cannot be adjusted, “-dB” appears in the front panel display.

Selecting the input mode

You can select the type of audio input signals of the selected input source according to your preference or the conditions of the input source. This function is available for TV/STB, DVD, and AUX.



We recommend setting the input mode to AUTO in most cases.

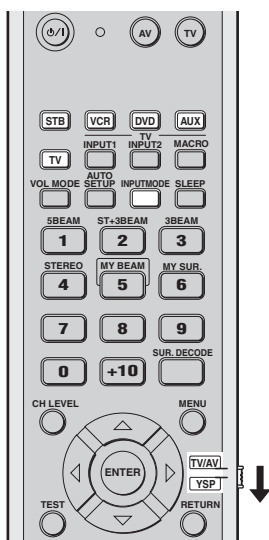

1 Set the operation mode selector to YSP.

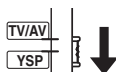

2 Press one of the input selector buttons to select the desired input source.

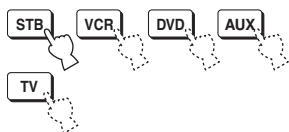

3 Press INPUTMODE repeatedly to toggle between input modes.

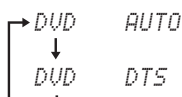
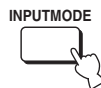

When DVD is selected as the input source

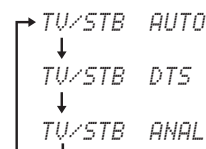

When TV or STB is selected as the input source

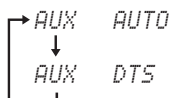

When AUX is selected as the input source

Note

ANALOG is not available as the input mode of DVD and AUX.

• AUTO

Automatically selects audio input signals in the following priority order:

- 1) Dolby Digital or DTS
- 2) PCM
- 3) Analog



Use this input mode in most cases.

• DTS

Selects only digital signals encoded in DTS.

Compared to AUTO, this input mode provides greater stability while playing back CDs or LDs encoded in DTS.

• ANALOG

Selects only analog signals.

Even when both digital and analog signals are input simultaneously, only analog signals are selected.



You can adjust the default input mode to be selected when the power of this unit is turned on by adjusting INPUT MODE in INPUT MENU (see page 64).

Adjusting the system parameters

This unit has additional menus that are displayed in the front panel display. These menus offer additional operations to adjust and customize the way this unit operates.

Note

When "F.PANEL KEY" is set to "F.PANEL: OFF" (see page 76), STANDBY/ON on the front panel is ineffective. Use STANDBY/ON on the remote control instead to adjust the system parameters.

Using the system parameters

Follow the procedure below to enter the system parameters.

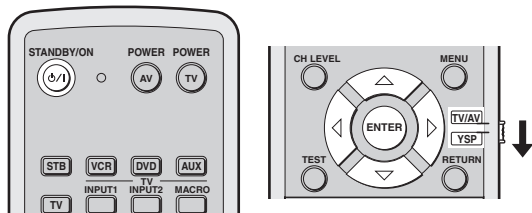

- 1 Press STANDBY/ON on the remote control to turn off the power of this unit.

STANDBY/ON



- 2 Press and hold INPUT on the front panel and press STANDBY/ON on the remote control to turn on the power of this unit.

"MEMORY PROTECT" is displayed in the front panel display.

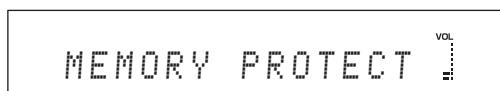
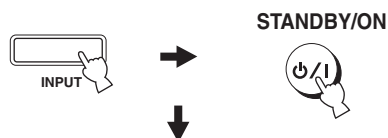

- 3 Release INPUT on the front panel.



Setting the MEMORY PROTECT

You can protect the settings you saved in the system memory of this unit from being accidentally erased or unwantedly changed.

1 Repeat steps 1 to 3 in “Using the system parameters” on page 71.

2 Set the operation mode selector to YSP.

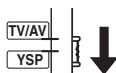

3 Confirm that “MEMORY PROTECT” is displayed in the front panel display and press ENTER.

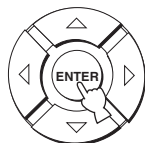
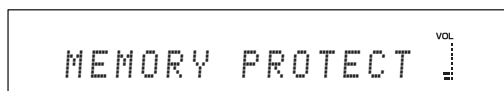

4 Press ◀/▶ to switch between “PROTECT: ON” and “PROTECT: OFF”.

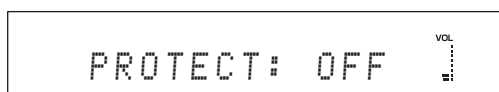
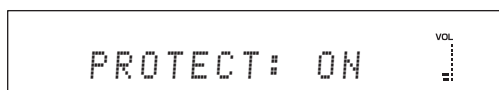
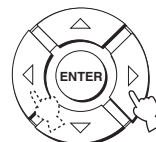

- Select PROTECT: ON to activate the protection feature.
- Select PROTECT: OFF to deactivate the protection feature.

5 Press STANDBY/ON on the remote control to set this unit to the standby mode.

STANDBY/ON



The new setting will be activated when you turn on the power of this unit next time.

Setting the MAX VOLUME

You can set the maximum volume level so that this unit will not output sound beyond the limited volume level.

1 Repeat steps 1 to 3 in “Using the system parameters” on page 71.

2 Set the operation mode selector to YSP.

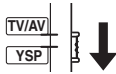

3 Press \triangle / ∇ so that “MAX VOLUME SET” is displayed in the front panel display.

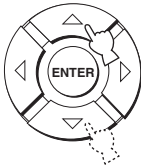

4 Press ENTER.

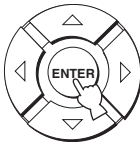

5 Press \triangle / ∇ to adjust the maximum volume level.

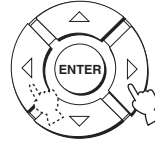

Control range: MAX, 99 to 01, MIN
Control step: 1

6 Press STANDBY/ON on the remote control to set this unit to the standby mode.

STANDBY/ON



The new setting for the maximum volume level will be activated when you turn on the power of this unit next time.

Setting the TURN ON VOLUME

You can set the initial volume level when the power of this unit is turned on.

1 Repeat steps 1 to 3 in “Using the system parameters” on page 71.

2 Set the operation mode selector to YSP.

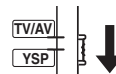

- 3** Press \triangle / ∇ so that “TURN ON VOLUME” is displayed in the front panel display.

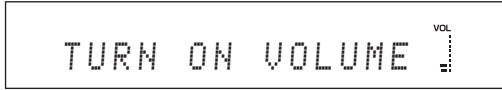

- 4** Press ENTER.

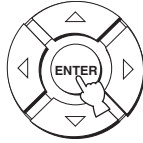

- 5** Press \triangleleft / \triangleright to adjust the initial volume level.

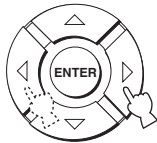

Control range: MAX, 99 to 01, OFF
Control step: 1

- 6** Press STANDBY/ON on the remote control to set this unit to the standby mode.

STANDBY/ON



The new setting for the maximum volume level will be activated when you turn on the power of this unit next time.

Setting the DEMO MODE

You can test the sound beam output from this unit to experience the sound beam.

- 1** Repeat steps 1 to 3 in “Using the system parameters” on page 71.

- 2** Set the operation mode selector to YSP.

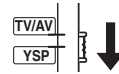

- 3** Press \triangle / ∇ so that “DEMO MODE” is displayed in the front panel display.

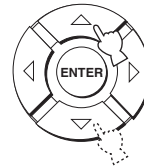

- 4** Press ENTER.

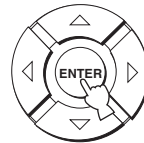

- 5** Press \triangle / ∇ to switch between “DEMO: ON” and “DEMO: OFF”.

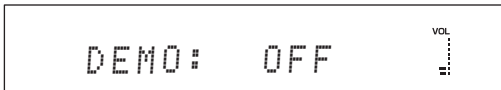
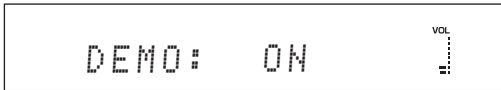
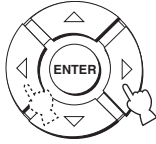

- Select DEMO: ON to activate the demo mode.
- Select DEMO: OFF to deactivate the demo mode.

- 6** Press **STANDBY/ON** on the remote control to set this unit to the standby mode.

STANDBY/ON



The new setting will be activated when you turn on the power of this unit next time.
Press ENTER while playing back sources to test the sound beam.
The sound beam being output shuttles between left and right. Press ENTER again to stop shuttling.

Setting the PANEL INP. KEY

You can disable the INPUT on the front panel when you adjust the system parameters.

- 1** Repeat steps 1 to 3 in “Using the system parameters” on page 71.
- 2** Set the operation mode selector to YSP.

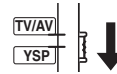

- 3** Press \triangle / ∇ so that “PANEL INP. KEY” is displayed in the front panel display.

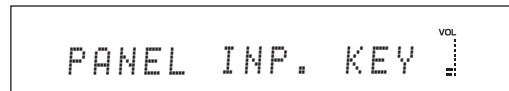
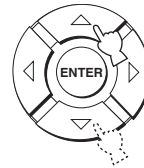

- 4** Press ENTER.

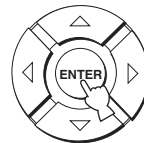

- 5 Press $\triangle / \triangleright$ to switch between “P.INPUT: ON” and “P.INPUT: OFF”.

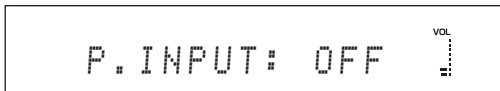
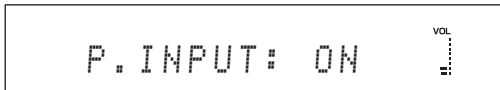
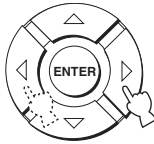

- Select P.INPUT: ON to enable the INPUT key on the front panel.
- Select P.INPUT: OFF to disable the INPUT key on the front panel. “F.PANEL KEY” is automatically set to “ON”.

- 6 Press **STANDBY/ON** on the remote control to set this unit to the standby mode.

STANDBY/ON



The new setting will be activated when you turn on the power of this unit next time.

Disabling the front panel keys

You can disable the front panel keys except when you adjust the system parameters.

- 1 Repeat steps 1 to 3 in “Using the system parameters” on page 71.

- 2 Set the operation mode selector to YSP.

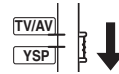

- 3 Press $\triangle / \triangleright$ so that “F.PANEL KEY” is displayed in the front panel display.

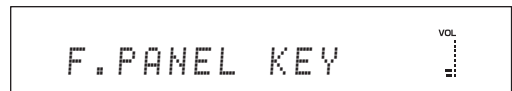

- 4 Press **ENTER**.

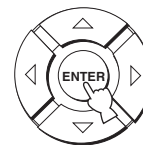

- 5** Press ◀ / ▶ to switch between “F.PANEL: ON” and “F.PANEL: OFF”.

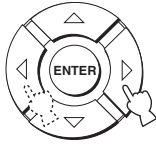

- Select F.PANEL: ON to enable the front panel keys.
- Select F.PANEL: OFF to disable the front panel keys. “P.INPUT” is automatically set to “ON”.

- 6** Press STANDBY/ON on the remote control to set this unit to the standby mode.

STANDBY/ON



The new setting will be activated when you turn on the power of this unit next time.

Setting the FACTORY PRESET

You can reset all of the parameters of this unit to the factory presets. This procedure completely resets ALL the parameters in SET MENU.

Note

After performing the following procedure you must run AUTO SETUP again to match your surround sound environment.

- 1** Repeat steps 1 to 3 in “Using the system parameters” on page 71.

- 2** Set the operation mode selector to YSP.

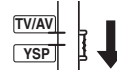

- 3** Press ▲ / ▼ so that “FACTORY PRESET” is displayed in the front panel display.

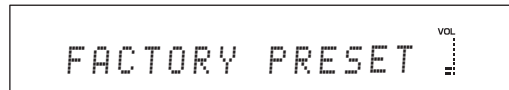
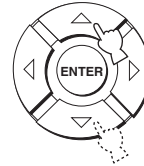

- 4** Press ENTER.

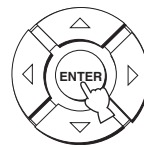

- 5** Press ◀ / ▶ to switch between “PRESET: RESET” and “PRESET: CANCEL”.

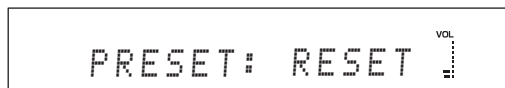
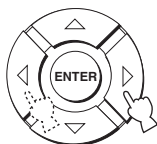

- Select PRESET: RESET to reset all of the current settings.
- Select PRESET: CANCEL to cancel the resetting procedure.

- 6** Press STANDBY/ON on the remote control to set this unit to the standby mode.

STANDBY/ON



The new setting will be activated when you turn on the power of this unit next time.

Remote control features

In addition to controlling this unit, the remote control can also operate other AV components made by Yamaha and other manufacturers. To control other components, you must set up the remote control with the appropriate remote control codes and set the operation mode selector to TV/AV to change the control area.

Note

Depending on the external AV component you are using, you may not be able to operate the component with the remote control, even if a remote control code is set. In this case, operate the component using the supplied remote control.

Setting remote control codes

You can control other components by setting the appropriate remote control codes. Codes can be set up for each input area (STB, VCR, DVD, AUX, and TV). For a complete list of available remote control codes, refer to “List of remote control codes” at the end of this manual.



- 1 Press and hold CODE SET and press one of the input selector buttons to select the input source you want to set a remote control code for.**

The transmission indicator flashes twice and remains lit.

Proceed to step 2 while holding down CODE SET.

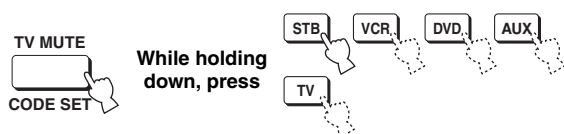

- 2 Press the numeric buttons to enter the remote control code while holding down CODE SET.**

Setting example: Yamaha DVD input area

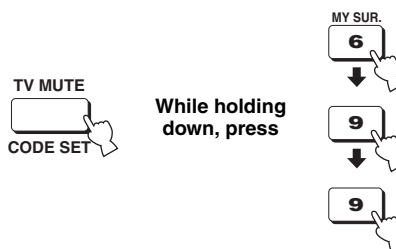

- 3 Refer to “Controlling other components” on page 80 to operate the external component using the remote control.**

If the external component functions correctly the remote control code setup is successful.

If the external component does not function correctly, the remote control code may be incorrect. Confirm that the remote control code is correct. See “List of remote control codes” at the end of this manual and start over from step 1.

Note

If the manufacturer of your component has more than one code, try each of them until you find the correct one.

If the remote control is without batteries for more than two minutes, or if exhausted batteries remain in the remote control, the contents of the memory may be cleared. When the memory is cleared, insert new batteries and reset the remote control codes. When changing the batteries, be careful not to press any of the buttons on the remote control. Doing so will clear the contents of the memory.

Controlling other components

■ Operating your TV

Set the operation mode selector to TV/AV, and press TV to select TV as the input source.

The control area of the remote control changes to the TV operation mode.

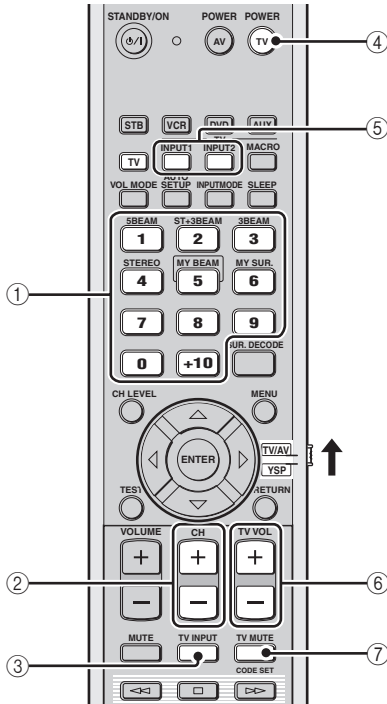

① Numeric buttons

Selects a TV channel for playback.

② CH +/-

Switches between the available TV channels.

③ TV INPUT

Switches the input source for your TV.

④ TV POWER

Turns on or off the power of your TV.

⑤ TV INPUT1/2

Selects the input source of your TV.

⑥ TV VOL +/-

Adjusts the audio output level of your TV.

⑦ TV MUTE

Temporarily mutes audio output from your TV.

■ Operating your DVD player/recorder

Set the operation mode selector to TV/AV and press DVD to select DVD as the input source.

The control area of the remote control changes to the DVD operation mode.

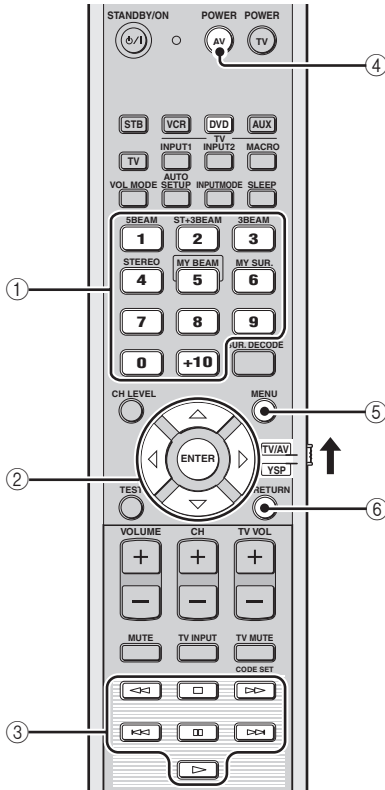

① Numeric buttons

Enter numeric digits.

② Cursor buttons \triangle / ∇ / \leftarrow / \rightarrow , ENTER

Use to select DVD menu items.

③ Operation buttons for DVD players

Operate your DVD player/recorder, such as play and stop.

④ AV POWER

Turns on or off the power of your DVD player/recorder.

⑤ MENU

Displays the DVD menu.

⑥ RETURN

Use to return to the previous DVD menu screen or exit from the DVD menu.

■ Operating your STB (CATV/Satellite tuner)

Set the operation mode selector to TV/AV and press STB to select STB as the input source.

The control area of the remote control changes to the STB operation mode.

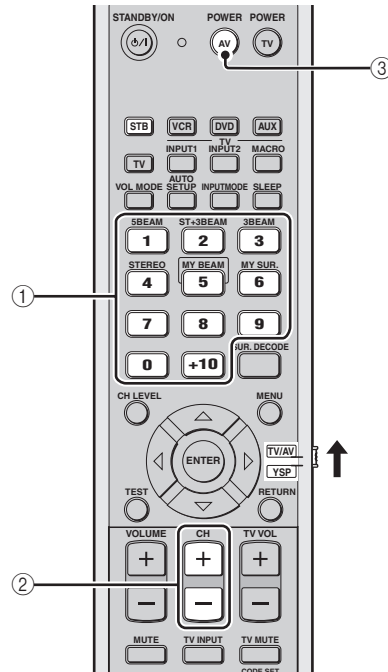

① Numeric buttons

Enter numeric digits.

② CH +/-

Switches between the available STB channels.

③ AV POWER

Turns on or off the power of your STB.

■ Operating your VCR

Set the operation mode selector to TV/AV and press VCR to select VCR as the input source.

The control area of the remote control changes to the VCR operation mode.

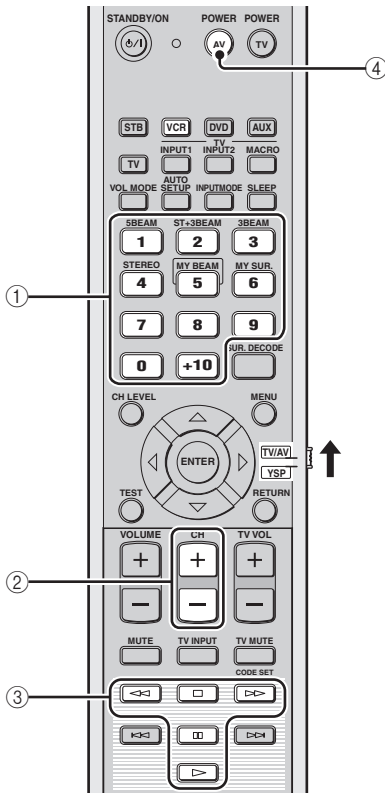

① Numeric buttons

Enter numeric digits.

② CH +/-

Switches between the available VCR channels.

③ Operation buttons for VCR

Operate your VCR, such as play and stop.

④ AV POWER

Turns on or off the power of your VCR.

Using the TV macro

The TV macro feature makes it possible to perform a series of operations with the press of a single button. For example, when you want to play a DVD, you would normally turn on the component, select DVD as the input source, and press the play button to start playback. The TV macro feature lets you perform all of these operations simply by pressing the DVD macro button.

Notes

- Be sure to set up a remote control code for your TV before setting macros.
- The ways to set macros differ if your TV does not have the tuning capability.
- If you press any control buttons on the remote control other than the ones used to set macros while setting macros, the setting procedure is automatically canceled.
- If it takes more than 10 seconds in steps 2 and 3, the setting procedure is automatically canceled. In this case, repeat from step 1.

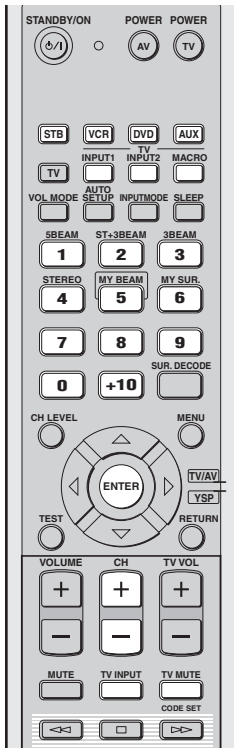

■ Setting macros for the TV with the tuning capability

- 1 Press and hold CODE SET and press one of the input selector buttons to select the input source you want to set macros for.**

Proceed to step 2 while holding down CODE SET.



- 2 Press MACRO while holding down CODE SET.**

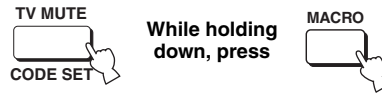

- 3 Press CH +/- or the numeric buttons to select the TV channel.**

Check that the TV screen changes to the tuner screen.

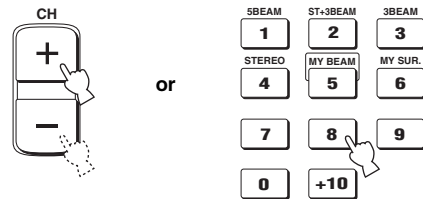

- 4 Press TV INPUT repeatedly until the screen changes to the display of the input source selected in step 1.**



- 5 Press ENTER to confirm the macro setting.**

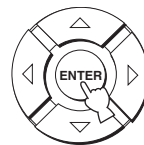

■ Setting macros for the TV without the tuning capability

- 1 Press and hold CODE SET and press one of the input selector buttons to select the input source you want to set macros for.**

Proceed to step 2 while holding down CODE SET.



- 2 Press MACRO while holding down CODE SET.**

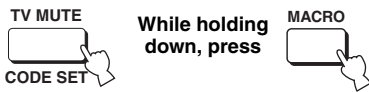

- 3 Press INPUT1.**

Check that the TV screen changes to the input 1 screen.



- 4 Press TV INPUT repeatedly until the screen changes to the display of the input source selected in step 1.**



- 5 Press ENTER to confirm the setting.**

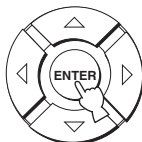

■ Operating macros

Press and hold one of the input selector buttons for approximately two seconds to select the input source you want to operate macros for.

The TV input changes at the same time the input mode changes.



■ Canceling the macros

- 1 Press and hold CODE SET and press one of the input selector buttons to select the input source you want to cancel the macros for.**

Proceed to step 2 while holding down CODE SET.



- 2 Press MACRO while holding down CODE SET.**

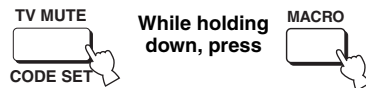

- 3 Press ENTER to cancel the macros.**

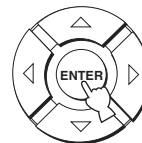

Troubleshooting

Refer to the chart below when this unit does not function properly. If the problem you are experiencing is not listed below or if the instruction below does not help, set this unit to the standby mode, disconnect the AC power supply cable, and contact the nearest authorized Yamaha dealer or service center.

■ General

Problem	Cause	Remedy	See page
This unit fails to turn on when STANDBY/ON is pressed, or enters the standby mode soon after the power has been turned on.	The AC power supply cable is not firmly connected to the AC wall outlet.	Connect the AC power supply cable firmly to the AC wall outlet.	25
	This unit has been exposed to a strong external electric shock (such as lightning and strong static electricity).	Set this unit to the standby mode, disconnect the AC power supply cable, plug it back in after 30 seconds, and use it normally.	—
This unit suddenly enters the standby mode.	The internal temperature becomes too high and the overheat protection circuitry has been activated.	Wait for about one hour for this unit to cool down and turn it back on.	—
	The sleep timer has turned the unit off.	Turn on the power and play back the source again.	—
No sound.	Incorrect input or output cable connections.	Connect the cables properly. If the problem persists, the cables may be defective.	16
	No appropriate input source has been selected.	Select an appropriate input source with INPUT or the input selector buttons.	41
	The volume is turned down.	Turn up the volume.	43
	The sound is muted.	Press MUTE or VOLUME +/- to resume audio output and adjust the volume level.	43
	The signals this unit cannot reproduce (such as PCM signals with more than 96 kHz of sampling frequency) are being received from the source component.	Play a source whose signals can be reproduced by this unit.	—
Change the system settings of the source component.		—	
The sound suddenly goes off.	The sleep timer has turned this unit off.	Turn on the power and play back the source again.	—
	The sound is muted.	Press MUTE or VOLUME +/- to resume audio output and adjust the volume level.	43
No sound from the effect channels.	You are playing back the source or program in the stereo playback or My Beam mode.	Press one of the beam mode buttons on the remote control to select a multi-channel playback mode and play back the source or program once more.	44
No sound from the center channel.	The output level of the center channel is set to minimum.	Raise the level of the center channel.	67
No sound from the surround channels.	The output level of the surround channels is set to minimum.	Raise the output level of the surround channels.	67

Problem	Cause	Remedy	See page
No sound from the subwoofer.	BASS OUT in SUBWOOFER SET is set to FRONT.	Select SWFR.	62
	The source does not contain low bass signals.		
Distorted or too little bass sound.	CROSS OVER in SUBWOOFER SET is set incorrectly.	Set CROSS OVER correctly.	62
	One of the night listening enhancers is currently selected.	Turn off the night listening enhancers.	53
Too much bass sound.	TruBass is currently turned on.	Turn off TruBass.	63
	The volume level of the subwoofer is too high.	Turn down the volume level of the subwoofer.	—
Surround sound effects are insubstantial.	The listening room is not a regular shape.	Install this unit in a square or rectangular shaped room.	—
	There is no wall in the path of the sound beam.	Try placing a flat object, such as a board, in the path of the sound beam.	—
Dolby Digital or DTS sources cannot be played back. (Dolby Digital or DTS indicator does not light up in the front panel display.)	The connected component is not set to output Dolby Digital or DTS digital signals.	Make an appropriate setting following the operating instructions for your component.	—
	The input mode is set to ANALOG.	Set the input mode to AUTO.	70
There is noise interference when a subwoofer is not connected to this unit.	The protection circuitry was in operation because a source with strong bass elements was played back.	Turn down the volume level.	43
		Select SWFR for BASS OUT.	62
		Connect a subwoofer and adjust settings for SUBWOOFER SET.	62
Low-frequency sounds are distorted.	CROSS OVER in SUBWOOFER SET is set incorrectly.	Set CROSS OVER correctly.	62
On-screen display does not appear.	The OSD video pin cable is not connected properly.	Connect the cable properly.	18
This unit does not operate properly.	The internal microcomputer has been frozen by an external electric shock (such as lightning or excessive static electricity) or by a power supply with low voltage.	Disconnect the AC power supply cable from the outlet and plug it in again after about 30 seconds.	—
There is noise interference from digital or high-frequency equipment.	This unit is too close to the digital or high-frequency equipment.	Move this unit farther away from such equipment.	—
This unit does not output effect sounds properly.	The original source includes surround effects.	Disable the surround effect settings of this unit.	—
My Beam auto-adjust function does not work.	The listening room is too noisy.	Keep the listening room as quiet as possible.	—
		Try manual-adjust function.	52
	The remote control may be operated outside of the remote control operation range.	The remote control functions within a maximum range of 6 m (20 ft) and no more than 30 degrees off-axis from the front panel.	26
	The function does not work properly because of the condition of the connected components.	Select My Beam and then try again.	51

■ Remote control

Problem	Cause	Remedy	See page
The remote control does not work and/or function properly.	Wrong distance or angle.	The remote control functions within a maximum range of 6 m (20 ft) and no more than 30 degrees off-axis from the front panel.	26
	Direct sunlight or lighting (from an inverter type of fluorescent lamp, etc.) is striking the remote control sensor of this unit.	Reposition this unit.	—
	The batteries are weak.	Replace all batteries.	26
Cannot operate external components with the remote control of this unit.	The external component you want to operate is not selected as the input source.	Press INPUT on the front panel or the input selector buttons on the remote control to select the external component you want to operate.	41
	The remote control code was not correctly set.	Set the remote control code correctly or try another code for the same manufacturer using the “List of remote control codes” at the end of this manual.	79
	Even if the remote control code is correctly set, there are some models that do not respond to the remote control.	Use the remote control supplied with the external component.	—
The cursor buttons do not work during SET MENU operation.	The operation mode selector was unwantedly set to TV/AV.	Set the operation mode selector to YSP.	—
Cannot use the My Beam auto-adjust function.	Wrong distance or angle.	The remote control functions within a maximum range of 6 m (20 ft) and no more than 30 degrees off-axis from the front panel.	51

Glossary

■ Dolby Digital

Dolby Digital is a digital surround sound system that gives you completely independent multi-channel audio. With 3 front channels (left, center, and right) and 2 surround stereo channels, Dolby Digital provides 5 full-range audio channels. With an additional channel especially for bass effects, called LFE (low-frequency effect), the system has a total of 5.1-channels (LFE is counted as 0.1-channel).

By using 2-channel stereo for the surround channels, more accurate moving sound effects and surround sound environment are possible than with Dolby Surround. The wide dynamic range (from maximum to minimum volume) reproduced by the 5 full-range channels and the precise sound orientation generated using digital sound processing provide listeners with excitement and realism previously unheard of.

With this unit, any sound environment from monaural up to a 5.1-channel configuration can be freely selected for your enjoyment.

■ Dolby Pro Logic II

Dolby Pro Logic II is an improved technique used to decode vast numbers of existing Dolby Surround software. This new technology enables a discrete 5-channel playback with 2 front left and right channels, 1 center channel, and 2 surround left and right channels (instead of only 1 surround channel for conventional Pro Logic technology). Music and Game modes are also available for 2-channel sources in addition to the Movie mode.

■ Dolby Surround

Dolby Surround uses a 4-channel analog recording system to reproduce realistic and dynamic sound effects: 2 front left and right channels (stereo), a center channel for dialog (monaural), and a surround channel for special sound effects (monaural). The surround channel reproduces sound within a narrow frequency range.

Dolby Surround is widely used with nearly all video tapes and laser discs, and in many TV and cable broadcasts as well. The Dolby Pro Logic decoder built into this unit employs a digital signal processing system that automatically stabilizes the volume on each channel to enhance moving sound effects and directionality.

■ DTS Digital Surround

DTS digital surround was developed to replace the analog soundtracks of movies with a 6-channel digital sound track, and is now rapidly gaining popularity in movie theaters around the world. DTS, Inc. has developed a home theater system so that you can enjoy the depth of sound and natural spatial representation of DTS digital surround in your home. This system produces practically distortion-free 6-channel sound (technically, left, right, and center channels, 2 surround channels, plus an LFE 0.1-channel as a subwoofer, for a total of 5.1 channels). The unit incorporates a DTS-ES decoder that enables 6.1-channel reproduction by adding the surround back channel to existing 5.1-channel format.

■ DTS Neo:6

Neo:6 decodes the conventional 2-channel sources for 6-channel playback by the specific decoder. It enables playback with the full-range channels with higher separation just like digital discrete signal playback. Two modes are available: Music mode for playing music sources and Cinema mode for movies.

■ EUPHONY

Euphony is a revolutionary sound field reproduction system implemented with state-of-the-art sound technologies developed under the basic concept of enjoying beautiful sound. It can reproduce surround sound optimized without depending on the number of input channels, the number of speakers (two or more speakers) or the speaker's dimensions. In addition, it features steady center localization. It also can reproduce the surround sound for the headphones with natural sound and "out-of-head" localization so that the listener feels an expanded sound and will not tire, even when listening to music or a movie for long time.

■ LFE 0.1-channel

This channel is for the reproduction of low bass signals. The frequency range for this channel is 20 Hz to 120 Hz. This channel is counted as 0.1 because it only enforces a low-frequency range compared to the full-range reproduction by the other 5/6 channels in Dolby Digital or DTS 5.1/6.1-channel systems.

■ PCM (Linear PCM)

Linear PCM is a signal format under which an analog audio signal is digitized, recorded, and transmitted without using any compression. This is used as a method of recording CDs and DVD audio. The PCM system uses a technique for sampling the size of the analog signal per very small unit of time. Standing for pulse code modulation, the analog signal is encoded as pulses and then modulated for recording.

■ SRS TruBass

SRS TruBass is a psychoacoustic bass enhancement technology developed by SRS Labs, Inc. for speakers and headphone systems that delivers bass up to an octave below the physical capabilities of the speaker's driver. SRS TruBass technology takes advantage of a spontaneous tendency of the human ears to infer low-range audio data when presented with higher-frequency harmonic signals. As a result, our ears can hear the original low-range sound that the speaker system is incapable of producing.

Index

■ Numerics

3 Beam	45
5 Beam	44

■ A

AC power supply cable	25
Audio pin cable	17
AUTO SETUP (IntelliBeam)	31

■ B

Battery	26
BEAM MENU	58
Beam mode	44, 50, 51

■ C

Cable clamp	17
Cardboard microphone stand	33

■ D

DEMO MODE	74
Demonstration DVD	6
Digital audio pin cable	17
DISPLAY MENU	66
Dolby Digital	46
Dolby Pro Logic	46
Dolby Pro Logic II	46
DTS	46
DTS Neo: 6	46
Dynamic range	63

■ E

EUPHONY	88
---------------	----

■ F

FACTORY PRESET	77
Front panel	7
Front panel display	8

■ I

IntelliBeam	31
IntelliBeam microphone	32

■ L

LFE 0.1-channel	89
-----------------------	----

■ M

MANUAL SETUP	56
MEMORY	38
My Beam	51

■ N

Night listening enhancer	53
--------------------------------	----

■ O

On-screen display (OSD)	28
Optical cable	17
OSD video pin cable	17

■ P

PCM	89
Power	27

■ R

Rear panel	9
Remote control	10
Remote control code	79
Remote control sensor	26

■ S

SET MENU	28
Sleep timer	54
Stereo plus 3 Beam	45
Surround mode	46
Surround sound	44
SOUND MENU	62
Stereo sound	50
System parameter	71

■ T

Test tone	67
TruBass	63
TV macro	83
TV volume equal mode	53

■ V

Volume	43
Volume mode	53

Specifications

AMP SECTION

- Maximum Output Power (JEITA)
..... 2 W (1 kHz, 10% THD, 4 Ω) × 16
..... 15 W (100 Hz, 10% THD, 4 Ω) × 2

SPEAKER SECTION

- Driver
 Small dia. speakers
 2.8 cm (1-3/32 in) cone magnetic shielding type × 16
 Woofers
 8 cm (3-5/32 in) cone magnetic shielding type × 2

CONNECTIONS

- Input Jacks
 TV/STB, VCR AUDIO IN (1 V, 32 kΩ) 2 pairs (Analog)
 TV/STB, AUX OPTICAL DIGITAL IN 2 (Optical digital)
 DVD COAXIAL DIGITAL IN 1 (Coaxial digital)
- Output Jacks
 SUBWOOFER OUT (1.5 V, less than 120 Hz) 1 (Subwoofer)
 VIDEO OUT (1 Vp-p, 75 Ω) 1 (OSD)
- System Connector Jack
 INTELLIBEAM MIC 1 (Microphone input)
 SYSTEM CONNECTOR 1 (System control)

GENERAL

- Power Supply
 [Australia model] AC 220–240 V, 50/60 Hz
 [U.K. and Europe models] AC 220–240 V, 50/60 Hz
 [Korea model] AC 220–240 V, 50/60 Hz
 [General model] AC 110–120 V, 50/60 Hz
 [Asia model] AC 220–240 V, 50/60 Hz
- Power Consumption 22 W
- Standby Power Consumption 0.1 W or less
- Dimensions (W x H x D) 610 × 120 × 220 mm
 (24 x 4-23/32 x 8-21/32 in)
- Weight 8.5 kg (18 lbs 12 oz)

* Specifications are subject to change without notice.

Limited Guarantee for European Economic Area (EEA) and Switzerland

Thank you for having chosen a Yamaha product. In the unlikely event that your Yamaha product needs guarantee service, please contact the dealer from whom it was purchased. If you experience any difficulty, please contact Yamaha representative office in your country. You can find full details on our website (<http://www.yamaha-hifi.com/> or <http://www.yamaha-uk.com/> for U.K. resident).

The product is guaranteed to be free from defects in workmanship or materials for a period of two years from the date of the original purchase. Yamaha undertakes, subject to the conditions listed below, to have the faulty product or any part(s) repaired, or replaced at Yamaha's discretion, without any charge for parts or labour. Yamaha reserves the right to replace a product with that of a similar kind and/or value and condition, where a model has been discontinued or is considered uneconomic to repair.

Conditions

1. The original invoice or sales receipt (showing date of purchase, product code and dealer's name) MUST accompany the defective product, along with a statement detailing the fault. In the absence of this clear proof of purchase, Yamaha reserves the right to refuse to provide free of charge service and the product may be returned at the customer's expense.
2. The product MUST have been purchased from an AUTHORISED Yamaha dealer within the European Economic Area (EEA) or Switzerland.
3. The product must not have been the subject of any modifications or alterations, unless authorised in writing by Yamaha.
4. The following are excluded from this guarantee:
 - a. Periodic maintenance and repair or replacement of parts due to normal wear and tear.
 - b. Damage resulting from:
 - (1) Repairs performed by the customer himself or by an unauthorised third party.
 - (2) Inadequate packaging or mishandling, when the product is in transit from the customer. Please note that it is the customer's responsibility to ensure the product is adequately packaged when returning the product for repair.
 - (3) Misuse, including but not limited to (a) failure to use the product for its normal purpose or in accordance with Yamaha's instructions on the proper use, maintenance and storage, and (b) installation or use of the product in a manner inconsistent with the technical or safety standards in force in the country where it is used.
 - (4) Accidents, lightning, water, fire, improper ventilation, battery leakage or any cause beyond Yamaha's control.
 - (5) Defects of the system into which this product is incorporated and/or incompatibility with third party products.
 - (6) Use of a product imported into the EEA and/or Switzerland, not by Yamaha, where that product does not conform to the technical or safety standards of the country of use and/or to the standard specification of a product sold by Yamaha in the EEA and/or Switzerland.
 - (7) Non AV (Audio Visual) related products.
(Products subject to "Yamaha AV Guarantee Statement" are defined in our website at <http://www.yamaha-hifi.com/> or <http://www.yamaha-uk.com/> for U.K. resident.)
5. Where the guarantee differs between the country of purchase and the country of use of the product, the guarantee of the country of use shall apply.
6. Yamaha may not be held responsible for any losses or damages, whether direct, consequential or otherwise, save for the repair or replacement of the product.
7. Please backup any custom settings or data, as Yamaha may not be held responsible for any alteration or loss to such settings or data.
8. This guarantee does not affect the consumer's statutory rights under applicable national laws in force or the consumer's rights against the dealer arising from their sales/purchase contract.

List of remote control codes

TV		PROSCAN 293, 221	VCR		PHILLIPS 325, 326, 328, 337, 356, 357
ADMIRAL 292, 293, 216	PROSCAN 231, 241, 251	PROTON 297, 250, 260, 270	ADMIRAL 395	PHONOLA 337	PILOT 396
AIWA 294, 276, 283, 284	QUASAR 234, 235	RADIO SHACK 299, 293, 297	AIWA 396, 397, 398, 329	PIONEER 325	QUASAR 325, 328
AKAI 295, 296	RCA 293, 297, 234, 256, 257, 258, 221	RUNCO 220, 230, 271	AKAI 322, 323, 324	RCA/PROSCAN	325, 326, 328, 333, 335, 349, 358, 363, 397
ALBA 296	SABA 223, 269, 265, 266	SAMPO 281, 297, 280	AUDIO DYNAMIC 392, 394	REALISTIC 393, 397, 328, 336, 359, 362, 396, 363	SAMSUNG 354, 358, 363, 364, 365, 366
AOC 297	SAMSUNG 262, 275	SANYO 295, 233, 279, 272, 273, 274, 212	BELL & HOWELL 393	SANSUI 394	SANYO 393, 336, 367
BELL & HOWELL 292	SCHNEIDER 296	SCOTT 297	BLAUPUNKT 325, 326	SCHNEIDER 337	SCOTT 399, 335, 336, 348, 359, 354, 358, 352
BESTAR 298	SCOTT 297	SHARP 292, 239, 232, 213	BROC SONIC 327	SELECO 322	SHARP 395, 362, 382
BLAUPUNKT 229, 222	SIEMENS 229	SIEMENS 229	BUSH 322	SIEMENS 393	SIGNATURE 2000 395, 397
BLUE SKY 298	SIGNATURE 216	SONY 263, 214	CANON 325, 328	SONY 368, 379, 372, 373, 374, 375	SYLVANIA 397, 325, 326, 328
BRANDT 223	SIGNATURE 292	SYLVANIA 297, 225, 298	CGM 396, 332	SYLVANIA 397, 325, 326, 328	SYMPHONIC 397
BROC SONIC 297	SONY 263, 214	SYMPHONIC 217, 218, 219	CITIZEN 396	TANDBERG 334	TANDY 397
BUSH 296	SYLVANIA 297, 225, 298	TELEFUNKUN 269, 264, 265, 266	CRAIG 396, 363	TANDY 397	TASHIRO 396
BYD:SIGN 201, 202	SYMPHONIC 217, 218, 219	THOMSON 223, 266	CURTHIS MATHIS 397, 328, 333	TATUNG 392, 394	TATUNG 392, 394, 397
CLATRONIC 298	TOSHIBA 292, 226, 267, 215	TOSHIBA 292, 226, 267, 215	DAEWOO 328, 334, 335	TEAC 392, 394, 397	TECHNICS 325, 328
CRAIG 224	VIDECH 297, 242	WARDS 297, 239, 232, 216	DBX 392, 394	TECHNICS 325, 328	TEKNIKA 396
CROSLEX 225, 298	YAMAHA 299, 292, 242, 285, 287, 253, 206	YAMAHA 299, 292, 242, 285, 287, 253, 206	DIMENSIA 333	TELEFUNKUN 376, 377	THOMAS 397
CURTIS MATHIS 297, 226	ZENITH 216, 261, 271	ZENITH 216, 261, 271	DYNATECH 397	THORN 393, 396	TOSHIBA 335, 389
DAEWOO 297, 298, 224, 227, 228	DVD PLAYER		EMERSON 327, 334, 396, 397	TOSHIBA 335, 389	TOTEVISION 363, 396
DAYTRON 239	AIWA 648, 649	APEX DIGITAL 652, 653, 654	FISHER 393, 336	UNITECH 363	UNIVERSUM 396, 327, 376
DUAL 298	BYD:SIGN 678, 679	DAEWOO 655	FUNAI 397	VIDEOSONIC 363	W.WHOUSE 396
DWIN 293, 281	DAEWOO 655	DENON 623, 624, 682	GE 328, 333, 387	WARDS 395, 396, 336, 362, 397, 363	YAMAHA 399, 392, 393, 394
EMERSON 297, 224, 239, 232	DENON 623, 624, 682	FUNAI 625	GO VIDEO 321, 331, 341, 351, 363	ZERITH 344, 361, 368, 371, 379, 396, 397	
FURGUSON 223, 265, 266	HARMAN/KARDON 656, 657	HITACHI 626	GOODMANS 334, 337		
FIRST LINE 298	HITACHI 626	JVC 627	GRUNDIG 332, 338		
FISHER 295, 233	JVC 627	KENWOOD 628	HITACHI 325, 333, 349, 342, 343		
FRABA 298	KENWOOD 628	KLH 658	INSTANT REPLAY 325, 328		
FUJITSU 289	LG/GOLDSTAR 645, 663, 664	LG/GOLDSTAR 645, 663, 664	ITTT/NOKIA 393		
FUNAI 277, 278	MARANTZ 699, 659	MARANTZ 699, 659	JC PENNY 392, 393, 394, 328, 333, 349, 396, 363		
GE 293, 297, 234, 235, 236	MITSUBISHI 629	ONKYO 632, 633, 634	JVC 392, 394, 344, 345, 346, 347		
GOODMANS 296, 298, 223	ONKYO 632, 633, 634	PANASONIC 623, 635, 668, 672, 682, 683, 684	KENDO 396		
GRUNDIG 229, 238, 249	PANASONIC 623, 635, 668, 672, 682, 683, 684	PHILIPS 699, 647, 659	KENWOOD 392, 394, 396		
HITACHI 297, 239, 242, 243, 285, 206	PHILIPS 699, 647, 659	PIONEER 636, 637, 638, 673, 674, 675, 685	LG/GOLDSTAR 396, 388		
ICE 296	PIONEER 636, 637, 638, 673, 674, 675, 685	RCA 639	LOEWE 396, 337		
IRRADIO 296	RCA 639	SAMSUNG 642	LUXOR 395		
ITTT/NOKIA 244, 245	SAMSUNG 642	SHARP 643	LXI 393, 396, 397, 336, 349		
JC PENNY 293, 297, 234, 237	SHARP 643	SONY 644, 676, 677	MAGNAVOX 325, 326, 328		
JVC 296, 246, 247, 286	SONY 644, 676, 677	SYLVANIA 662	MARANTZ 392, 394		
KENDO 298	SYLVANIA 662	SYMPHONIC 662	MARTA 396		
KTV 297, 239	SYMPHONIC 662	THOMSON 646	MATSUI 396		
LG/GOLDSTAR 297, 298, 239, 237	THOMSON 646	TOSHIBA 634, 665, 666, 667	MEMOREX 328, 336, 396, 397		
LOEWE 298, 248	TOSHIBA 634, 665, 666, 667	YAMAHA 699, 622, 623, 647, 682	MINOLTA 333, 349		
LXI 293, 297, 225, 226, 233, 298	YAMAHA 699, 622, 623, 647, 682	ZERITH 663, 664	MITSUBISHI 399, 344, 348, 359, 353, 352		
MAGNAVOX 297, 225, 239, 298	ZERITH 663, 664		MTC 363, 397		
MARANTZ 298, 210			MULTITECH 397, 348, 354		
MATSUI 295			NEC 392, 394, 344, 383		
MEDION 203, 204, 298			NOKIA 393, 395		
MEMOREX 297, 216			NOKIA OCEANIC 395		
MITSUBISHI 299, 297, 259, 287			OKANO 323		
NAD 226, 255			OLYMPIC 325, 328		
NEC 297, 252, 282			ORION 327		
NOKIA 244, 245			PANASONIC 325, 328, 339, 355, 378, 384, 385, 386		
NOKIA OCEANIC 245			PENTAX 333, 349		
NORDMENDE 265, 266			PHILCO 325, 328, 397		
ONWA 296					
PANASONIC 234, 235, 236, 253, 288, 211					
PHILCO 297, 225, 239, 298					
PHILIPS 298, 225, 205					
PIONEER 226, 235, 254, 255, 268					
PORTLAND 297, 256					

CABLE TV TUNER

ABC 739, 752, 753, 755, 758, 759, 762
GENERAL INSTRUMENT 722
HAMIN 723, 724, 725, 726, 727
HITACHI 722
JEROLD 722, 728, 729, 732, 733, 734, 735, 736, 737
MAGNAVOX 738
MOTOROLA 748
OAK 739, 742, 743
PANASONIC 744, 745, 746, 747, 783, 784

PHILLIPS 763, 764, 765,
766, 767, 768
PIONEER 748, 785, 747
RADIO SHACK 749
SCIENTIFIC ATLANTA
752, 753, 754
SONY 756, 757
TOCOM 755
UNIVERSAL 769, 772, 773,
774, 775
VIEWSTAR 764, 766, 776,
777, 778, 779, 782

SATELLITE TUNER

ECHOSTAR 822
GE 837, 838, 839
GENERAL INSTRUMENT
823
HITACHI 824
HUGHES 843, 844, 845, 846
JVC 822
MAGNAVOX 825
PANASONIC 826, 829

PHILLIPS 825, 843, 844,
845, 846, 847,
848, 849
PRIMESTAR 827
PROSCAN 837, 838, 839, 842
RADIO SHACK
828
RCA 837, 838, 839, 842
SAMSUNG 852
SONY 832, 835
TOSHIBA 833, 836
UNIDEN 825
ZENITH 834



© 2007 YAMAHA CORPORATION All rights reserved.

YAMAHA ELECTRONICS CORPORATION, USA 6660 ORANGETHORPE AVE., BUENA PARK, CALIF. 90620, U.S.A.
YAMAHA CANADA MUSIC LTD. 135 MILNER AVE., SCARBOROUGH, ONTARIO M1S 3R1, CANADA
YAMAHA ELECTRONIK EUROPA G.m.b.H. SIEMENSSTR. 22-34, 25462 RELINGEN BEI HAMBURG, GERMANY
YAMAHA ELECTRONIQUE FRANCE S.A. RUE AMBROISE CROIZAT BP70 CROISSY-BEAUBOURG 77312 MARNE-LA-VALLEE CEDEX02, FRANCE
YAMAHA ELECTRONICS (UK) LTD. YAMAHA HOUSE, 200 RICKMANSWORTH ROAD WATFORD, HERTS WD18 7GQ, ENGLAND
YAMAHA SCANDINAVIA A.B. J A WETTERGRENS GATA 1, BOX 30053, 400 43 VÄSTRA FRÖUNDA, SWEDEN
YAMAHA MUSIC AUSTRALIA PTY, LTD. 17-33 MARKET ST., SOUTH MELBOURNE, 3205 VIC., AUSTRALIA

YAMAHA CORPORATION
Printed in Malaysia © WM28780



YSP-500

QUICK REFERENCE GUIDE

Items used for connections and operations in this guide

- Audio pin cable (x1)
- OSD* video pin cable (x1)
- Optical cable (x1)
- Digital audio pin cable (x1)
- IntelliBeam microphone (x1)
- Cardboard microphone stand (x1)
- Demonstration DVD (x1)

*OSD: On-Screen Display

This quick reference guide explains steps to connect a TV and a DVD player to this unit and achieve the surround sound effects in a quick, easy manner. For detailed operation, refer to the Owner's Manual.

1 Installing this unit

Decide where to install this unit.

Install this unit where there are no objects such as furniture obstructing the path of sound beams. Otherwise, the desired surround sound effects may not be achieved. You may install this unit in parallel with the wall or in the corner.

Install this unit in the exact center of the wall when it is measured from the left and right corners.

An object, such as furniture

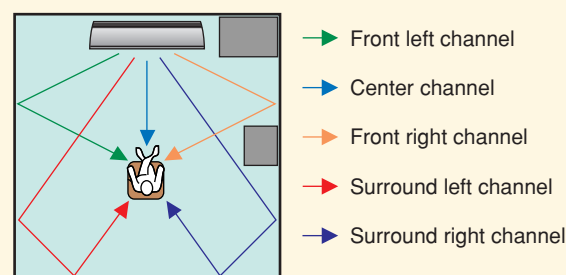

Install this unit in the corner at a 40° to 50° angle from the adjacent walls.

An object, such as furniture

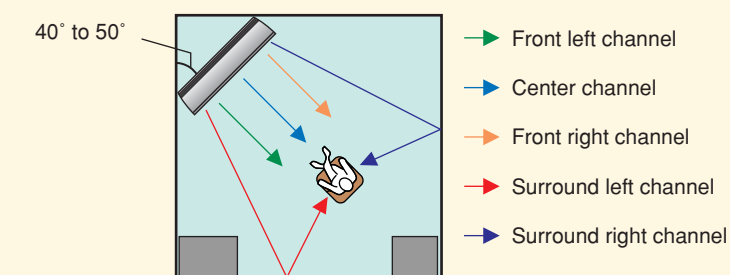

Install this unit using a rack, etc.

Depending on your installation environment, connections with external components (see "2 Connecting external components to this unit") can be done before installing this unit. We recommend that you temporarily place and arrange all components in order to decide which procedure must come first. For further information on installation, see page 13 in the Owner's Manual.

The following is an example of installing this unit in a rack.

- ① Place this unit in front of the rack.
- ② Connect this unit to your TV and DVD player.
- ③ Install this unit in the rack.
- ④ Installation is completed.

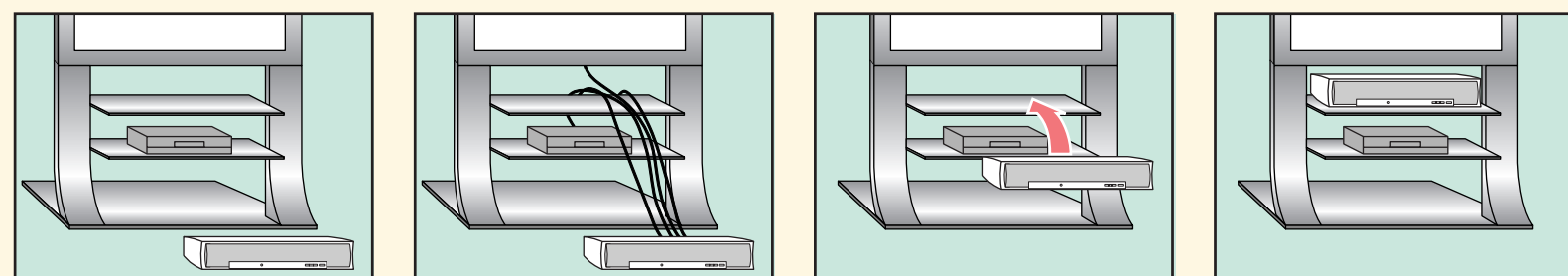

To enjoy better surround effects, place this unit on the upper shelf to keep it away from the floor.



Be careful not to leave scratches on this unit or the rack.

2 Connecting external components to this unit

Connecting external components such as a TV or DVD player to this unit.

Connect your TV or DVD player to this unit using appropriate cables as shown below. After all connections are complete, plug the power supply cable into the AC wall outlet. For further information on connecting other components, see pages 16 to 24 in the Owner's Manual.

This connection example shows a way to connect external components such as a TV or DVD player to this unit by using the supplied cable. You can enjoy the multi-channel audio from the DVD player and the analog/digital audio from the TV. Use the video pin cable supplied with your DVD player to make a video connection between your DVD player and TV.

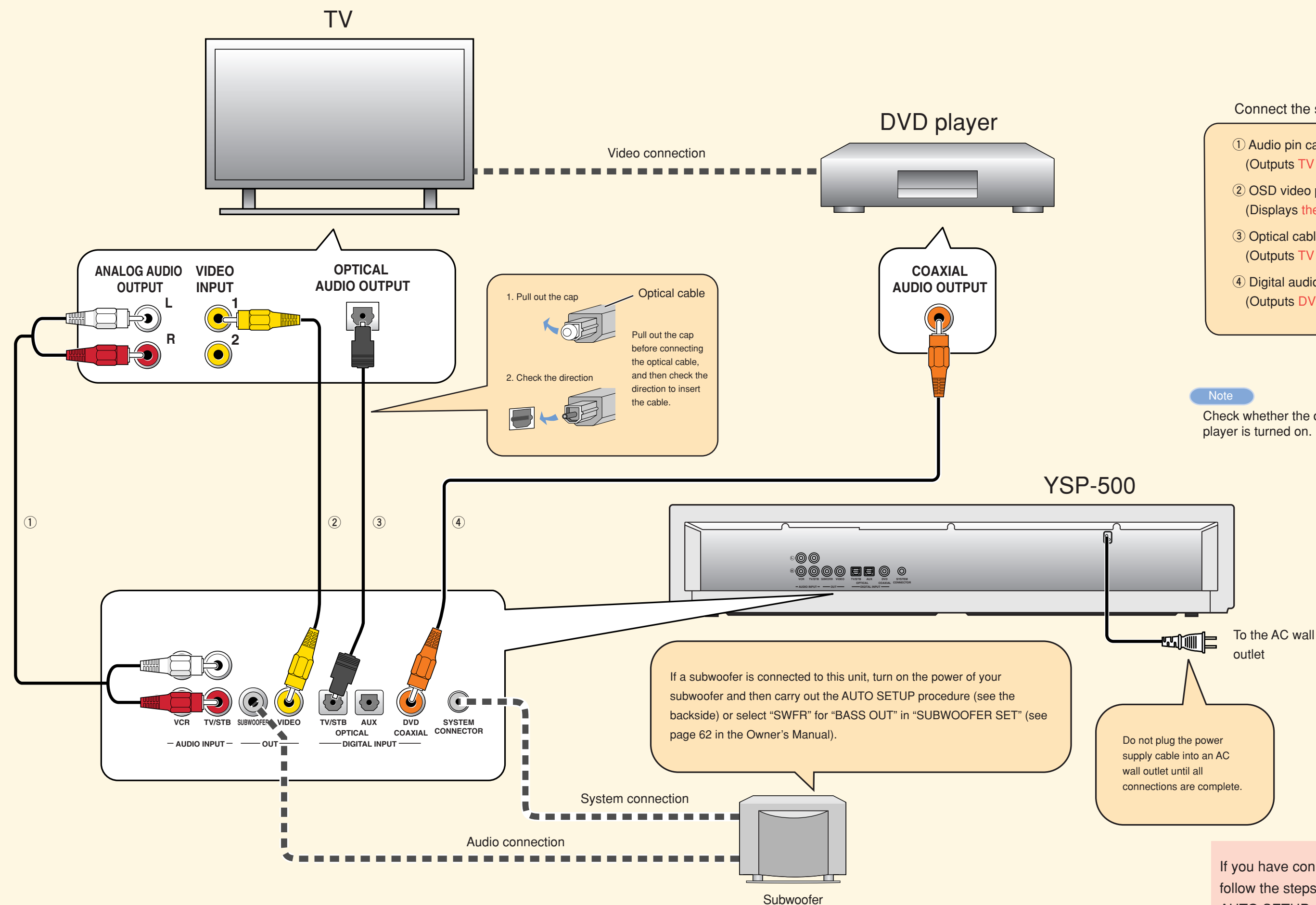

If you have connected external components, follow the steps on the backside to start the AUTO SETUP procedure.

Continued on the back

3 Carry out the AUTO SETUP (IntelliBeam)

Carry out the AUTO SETUP to adjust the settings that best match your listening environment

The IntelliBeam technology allows you to achieve sound adjustments that best match your listening environment. It is normal for loud test tones to be output during the AUTO SETUP procedure. Make sure that there are no children around in the listening room while the AUTO SETUP procedure is in progress.

1 Connect the supplied IntelliBeam microphone to the INTELLIBEAM MIC jack on the front panel.

You may want to use the supplied cardboard microphone stand for the AUTO SETUP. Assemble the stand and place the IntelliBeam microphone on top of it as shown below.

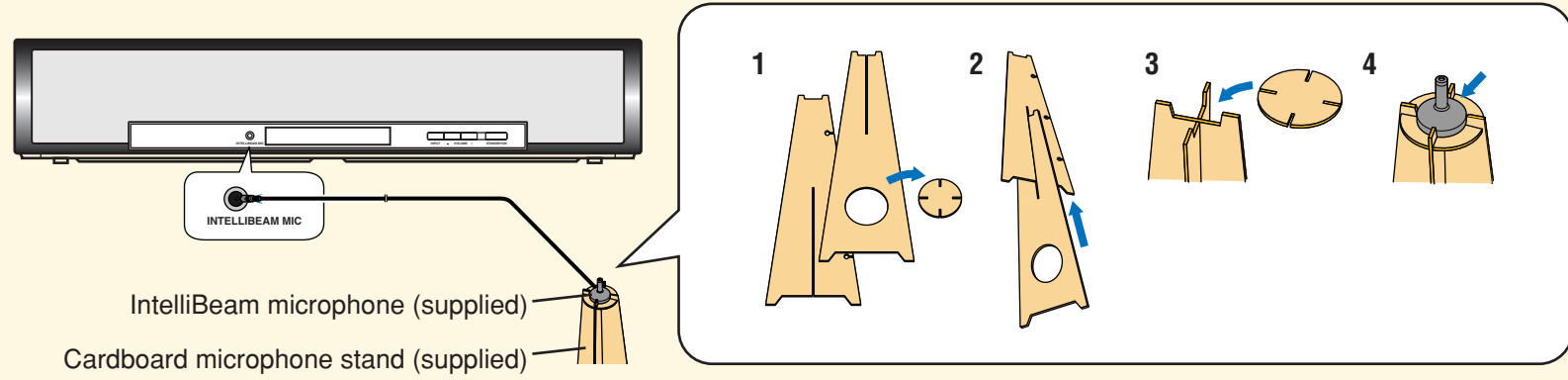

2 Set the IntelliBeam microphone at your normal listening position.

Use the supplied cardboard microphone stand or a tripod to place the IntelliBeam microphone at the same height as your ears would be when you are seated.

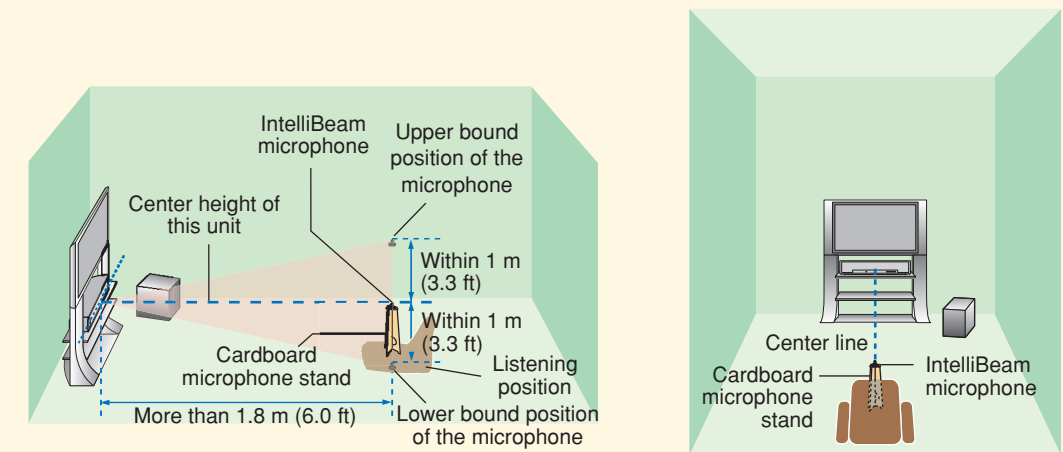

Place the IntelliBeam microphone on the extended center line of this unit and 1.8 m (6.0 ft) or more away from it. Also, make sure place the IntelliBeam microphone within 1 m (3.3 ft) upper or lower from the center height of this unit.

3 Press STANDBY/ON on the remote control.

The power of this unit turns on. Before operations, insert batteries into the remote control (see page 26 in the Owner's Manual). If necessary, adjust the volume level of this unit. If you have connected the subwoofer, set the volume and crossover/high cut frequency. Refer to the note on page 32 in the Owner's Manual.

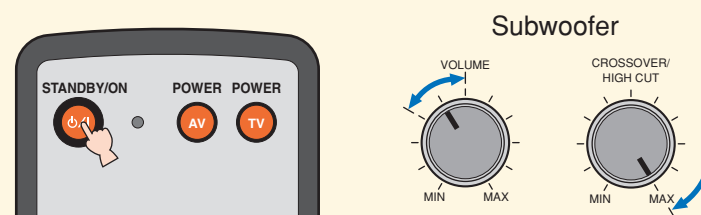

4 Turn on the power of your TV.

5 Select the appropriate video input on your TV.

"YSP-500" appears on your TV. If the OSD video pin cable is connected to the video input 1 on the TV as shown in the connection example, switch the video input to "1".

6 Set the operation mode selector to YSP.

This unit switches to the YSP operation mode.

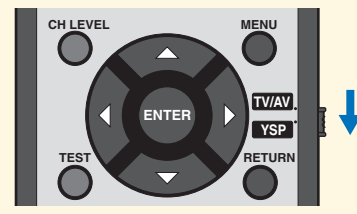

7 Press and hold AUTO SETUP for more than 2 seconds.

The menu screen appears on the TV. If the menu screen does not appear, check the OSD video pin cable (see the connection example on the front page).

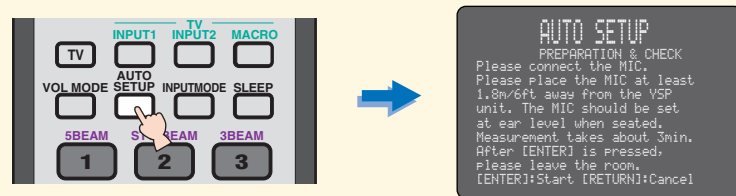

8 Check the following points.

About the IntelliBeam microphone

- Is the microphone placed on an imaginary center line drawn from this unit?
- Is the microphone placed within 1 m (3.3 ft) upper or lower from the center height of this unit?
- Is the microphone placed more than 1.8 m (6.0 ft) from the front of this unit?

About the room environment

- Is your listening room kept as quiet as possible?

9 Prepare to leave the room.

The best setting may not be done if you are in the room. Prepare to leave the room in 10 seconds after pressing ENTER in step 10.

Hint

- When leaving the room, bring this guide with you.
- Wait outside the room during the AUTO SETUP procedure.
- The AUTO SETUP procedure takes about 3 minutes.
- To cancel the AUTO SETUP procedure after it is started, press RETURN.

10 Press ENTER to start the AUTO SETUP procedure, and then leave the room within 10 seconds.

The following screen appears on the TV. Leave the room within 10 seconds before the AUTO SETUP procedure starts.

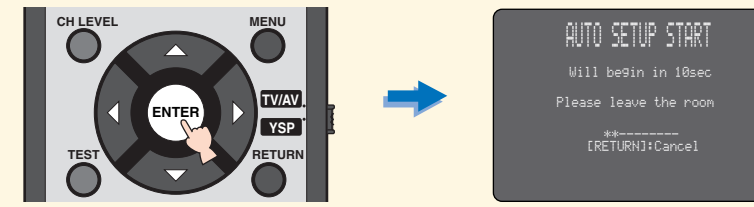

The setup screen automatically changes during the AUTO SETUP procedure.

When the AUTO SETUP procedure is completed, the following screen appears on the TV.

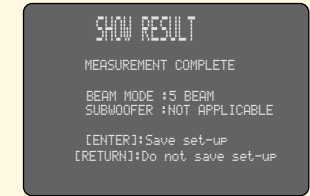

If "ENVIRONMENT CHECK (FAILED)" is displayed, see page 36 in the Owner's Manual and then run the procedure again.

Hint

- The result may differ depending on the environment.
- If any error occurs, the corresponding error message appears on the screen. In this case, see "Error messages for AUTO SETUP" on page 37 in the Owner's Manual and then follow the instructions. To start the AUTO SETUP procedure once again, press RETURN.

11 Press ENTER.

The following screen appears on the TV for 2 seconds and then the menu screen disappears from the TV.

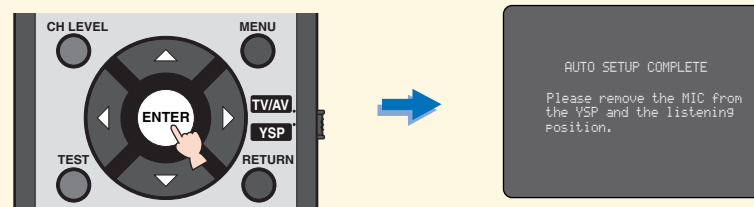

12 Disconnect the IntelliBeam microphone.

The AUTO SETUP has completed. Keep the IntelliBeam microphone in a safe place. The settings are automatically saved in the system memory.

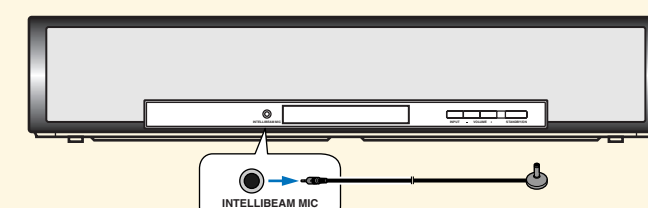

4 Enjoying surround sound

Enjoy TV or DVD digital audio in surround sound.

For instructions on how to operate or set your TV or DVD player, refer to the owner's manual supplied with each component.

Enjoying DVDs in surround sound

1 Select the DVD video input on your TV.

2 Set the operation mode selector to YSP.

This unit switches to the YSP operation mode.

3 1) Press DVD on the remote control of this unit.

This unit switches to the DVD playback mode.

2) Play back the supplied demonstration DVD on the DVD player.

4 Check the multi-channel digital signal being output at this unit.

The MULTI indicator and/or (see page 42 in the Owner's Manual) is lit in the front panel display. If the sound is output from your TV speakers, mute the volume on your TV. For details about digital audio input signals, see page 46 in the Owner's Manual.

5 Press VOLUME +/- on the remote control to adjust the volume level of this unit.

6 Press one of the beam mode buttons on the remote control to select the desired beam mode.

Select one of the six beam modes that best matches the current input source of this unit. For further information on the beam modes, see page 44 in the Owner's Manual.

To fine-tune the listening environment parameters manually or make advanced settings for speaker positions, sound beams, etc., see "MANUAL SETUP" on page 56 in the Owner's Manual.

Enjoying TV in surround sound

1 Select the TV channel using the remote control supplied with your TV.

2 Set the operation mode selector to YSP.

This unit switches to the YSP operation mode.

3 Press TV on the remote control of this unit.

This unit switches to the TV playback mode.

MULTI indicator

