

Portable Grand™

DGX-505

DGX-305

Owner's Manual



SmartMedia™



SPECIAL MESSAGE SECTION

This product utilizes batteries or an external power supply (adapter). DO NOT connect this product to any power supply or adapter other than one described in the manual, on the name plate, or specifically recommended by Yamaha.

This product should be used only with the components supplied or; a cart, rack, or stand that is recommended by Yamaha. If a cart, etc., is used, please observe all safety markings and instructions that accompany the accessory product.

SPECIFICATIONS SUBJECT TO CHANGE:

The information contained in this manual is believed to be correct at the time of printing. However, Yamaha reserves the right to change or modify any of the specifications without notice or obligation to update existing units.

This product, either alone or in combination with an amplifier and headphones or speaker/s, may be capable of producing sound levels that could cause permanent hearing loss. DO NOT operate for long periods of time at a high volume level or at a level that is uncomfortable. If you experience any hearing loss or ringing in the ears, you should consult an audiologist.

IMPORTANT: The louder the sound, the shorter the time period before damage occurs.

NOTICE:

Service charges incurred due to a lack of knowledge relating to how a function or effect works (when the unit is operating as designed) are not covered by the manufacturer's warranty, and are therefore the owners responsibility. Please study this manual carefully and consult your dealer before requesting service.

ENVIRONMENTAL ISSUES:

Yamaha strives to produce products that are both user safe and environmentally friendly. We sincerely believe that our products and the production methods used to produce them, meet these goals. In keeping with both the letter and the spirit of the law, we want you to be aware of the following:

Battery Notice:

This product MAY contain a small non-rechargeable battery which (if applicable) is soldered in place. The average life span of this type of battery is approximately five years. When replacement becomes necessary, contact a qualified service representative to perform the replacement.

This product may also use "household" type batteries. Some of these may be rechargeable. Make sure that the battery being charged is a rechargeable type and that the charger is intended for the battery being charged.

When installing batteries, do not mix batteries with new, or with batteries of a different type. Batteries MUST be installed correctly. Mismatches or incorrect installation may result in overheating and battery case rupture.

Warning:

Do not attempt to disassemble, or incinerate any battery. Keep all batteries away from children. Dispose of used batteries promptly and as regulated by the laws in your area. Note: Check with any retailer of household type batteries in your area for battery disposal information.

Disposal Notice:

Should this product become damaged beyond repair, or for some reason its useful life is considered to be at an end, please observe all local, state, and federal regulations that relate to the disposal of products that contain lead, batteries, plastics, etc. If your dealer is unable to assist you, please contact Yamaha directly.

NAME PLATE LOCATION:

The name plate is located on the bottom of the product. The model number, serial number, power requirements, etc., are located on this plate. You should record the model number, serial number, and the date of purchase in the spaces provided below and retain this manual as a permanent record of your purchase.

Model

Serial No.

Purchase Date

PLEASE KEEP THIS MANUAL

FCC INFORMATION (U.S.A.)

1. IMPORTANT NOTICE: DO NOT MODIFY THIS UNIT!

This product, when installed as indicated in the instructions contained in this manual, meets FCC requirements. Modifications not expressly approved by Yamaha may void your authority, granted by the FCC, to use the product.

2. IMPORTANT:

When connecting this product to accessories and/or another product use only high quality shielded cables. Cable/s supplied with this product MUST be used. Follow all installation instructions. Failure to follow instructions could void your FCC authorization to use this product in the USA.

3. NOTE:

This product has been tested and found to comply with the requirements listed in FCC Regulations, Part 15 for Class "B" digital devices. Compliance with these requirements provides a reasonable level of assurance that your use of this product in a residential environment will not result in harmful interference with other electronic devices. This equipment generates/uses radio frequencies and, if not installed and used according to the instructions found in the users manual, may cause interference harmful to the operation of other electronic devices. Compliance with FCC regulations does

not guarantee that interference will not occur in all installations. If this product is found to be the source of interference, which can be determined by turning the unit "OFF" and "ON", please try to eliminate the problem by using one of the following measures:

Relocate either this product or the device that is being affected by the interference.

Utilize power outlets that are on different branch (circuit breaker or fuse) circuits or install AC line filter/s.

In the case of radio or TV interference, relocate/reorient the antenna. If the antenna lead-in is 300 ohm ribbon lead, change the lead-in to co-axial type cable.

If these corrective measures do not produce satisfactory results, please contact the local retailer authorized to distribute this type of product. If you can not locate the appropriate retailer, please contact Yamaha Corporation of America, Electronic Service Division, 6600 Orangethorpe Ave, Buena Park, CA90620

The above statements apply ONLY to those products distributed by Yamaha Corporation of America or its subsidiaries.

* This applies only to products distributed by YAMAHA CORPORATION OF AMERICA.

(class B)

OBSERVERA!

Apparaten kopplas inte ur växelströmskällan (nätet) så länge som den är ansluten till vägguttaget, även om själva apparaten har stängts av.

ADVARSEL: Netspændingen til dette apparat er IKKE afbrudt, så længe netledningen sidder i en stikkontakt, som er tændt — også selvom der er slukket på apparatets afbryder.

VAROITUS: Laitteen toisiopiiriin kytketty käyttökyltkin ei irroita koko laitetta verkosta.

(standby)

Entsorgung leerer Batterien (nur innerhalb Deutschlands)

Leisten Sie einen Beitrag zum Umweltschutz. Verbrauchte Batterien oder Akkumulatoren dürfen nicht in den Hausmüll. Sie können bei einer Sammelstelle für Altbatterien bzw. Sondermüll abgegeben werden. Informieren Sie sich bei Ihrer Kommune.

(battery)

PRECAUTIONS

PLEASE READ CAREFULLY BEFORE PROCEEDING

* Please keep this manual in a safe place for future reference.



WARNING

Always follow the basic precautions listed below to avoid the possibility of serious injury or even death from electrical shock, short-circuiting, damages, fire or other hazards. These precautions include, but are not limited to, the following:

Power supply/AC power adaptor

- Only use the voltage specified as correct for the instrument. The required voltage is printed on the name plate of the instrument.
- Use the specified adaptor (PA-5D, PA-5C or an equivalent recommended by Yamaha) only. Using the wrong adaptor can result in damage to the instrument or overheating.
- Check the electric plug periodically and remove any dirt or dust which may have accumulated on it.
- Do not place the AC adaptor cord near heat sources such as heaters or radiators, and do not excessively bend or otherwise damage the cord, place heavy objects on it, or place it in a position where anyone could walk on, trip over, or roll anything over it.

Do not open

- Do not open the instrument or attempt to disassemble the internal parts or modify them in any way. The instrument contains no user-serviceable parts. If it should appear to be malfunctioning, discontinue use immediately and have it inspected by qualified Yamaha service personnel.

Water warning

- Do not expose the instrument to rain, use it near water or in damp or wet conditions, or place containers on it containing liquids which might spill into any openings.
- Never insert or remove an electric plug with wet hands.

Fire warning

- Do not put burning items, such as candles, on the unit. A burning item may fall over and cause a fire.

If you notice any abnormality

- If the AC adaptor cord or plug becomes frayed or damaged, or if there is a sudden loss of sound during use of the instrument, or if any unusual smells or smoke should appear to be caused by it, immediately turn off the power switch, disconnect the adaptor plug from the outlet, and have the instrument inspected by qualified Yamaha service personnel.



CAUTION

Always follow the basic precautions listed below to avoid the possibility of physical injury to you or others, or damage to the instrument or other property. These precautions include, but are not limited to, the following:

Power supply/AC power adaptor

- When removing the electric plug from the instrument or an outlet, always hold the plug itself and not the cord.
- Unplug the AC power adaptor when not using the instrument, or during electrical storms.
- Do not connect the instrument to an electrical outlet using a multiple-connector. Doing so can result in lower sound quality, or possibly cause overheating in the outlet.

Battery

- Always make sure all batteries are inserted in conformity with the +/- polarity markings. Failure to do so might result in overheating, fire, or battery fluid leakage.
- Always replace all batteries at the same time. Do not use new batteries together with old ones. Also, do not mix battery types, such as alkaline batteries with manganese batteries, or batteries from different makers, or different types of batteries from the same maker, since this can cause overheating, fire, or battery fluid leakage.

- Do not dispose of batteries in fire.
- Do not attempt to recharge batteries that are not intended to be charged.
- When the batteries run out, or if the instrument is not to be used for a long time, remove the batteries from the instrument to prevent possible leakage of the battery fluid.
- Keep batteries away from children.
- If the batteries do leak, avoid contact with the leaked fluid. If the battery fluid should come in contact with your eyes, mouth, or skin, wash immediately with water and consult a doctor. Battery fluid is corrosive and may possibly cause loss of sight or chemical burns.

Location

- Do not expose the instrument to excessive dust or vibrations, or extreme cold or heat (such as in direct sunlight, near a heater, or in a car during the day) to prevent the possibility of panel disfiguration or damage to the internal components.
- Do not use the instrument in the vicinity of a TV, radio, stereo equipment, mobile phone, or other electric devices. Otherwise, the instrument, TV, or radio may generate noise.
- Do not place the instrument in an unstable position where it might accidentally fall over.
- Before moving the instrument, remove all connected adaptor and other cables.
- Use only the stand specified for the instrument. When attaching the stand or rack, use the provided screws only. Failure to do so could cause damage to the internal components or result in the instrument falling over.

Connections

- Before connecting the instrument to other electronic components, turn off the power for all components. Before turning the power on or off for all components, set all volume levels to minimum. Also, be sure to set the volumes of all components at their minimum levels and gradually raise the volume controls while playing the instrument to set the desired listening level.

Maintenance

- When cleaning the instrument, use a soft, dry cloth. Do not use paint thinners, solvents, cleaning fluids, or chemical-impregnated wiping cloths.

Handling caution

- Do not insert a finger or hand in any gaps on the instrument.
- Never insert or drop paper, metallic, or other objects into the gaps on the panel or keyboard. If this happens, turn off the power immediately and unplug the power cord from the AC outlet. Then have the instrument inspected by qualified Yamaha service personnel.
- Do not place vinyl, plastic or rubber objects on the instrument, since this might discolor the panel or keyboard.
- Do not rest your weight on, or place heavy objects on the instrument, and do not use excessive force on the buttons, switches or connectors.
- Do not operate the instrument for a long period of time at a high or uncomfortable volume level, since this can cause permanent hearing loss. If you experience any hearing loss or ringing in the ears, consult a physician.

Saving data

Saving and backing up your data

- The panel settings and some other types of data (page 49) will be lost if the power is turned off before they are saved. Be sure to save data you want to keep to the internal Flash Memory (page 49) before turning off the power. Saved data may be lost due to malfunction or incorrect operation. Save important data to a SmartMedia Card (see page 75).

Backing up the SmartMedia

- To protect against data loss through media damage, we recommend that you save your important data onto two SmartMedia.

Yamaha cannot be held responsible for damage caused by improper use or modifications to the instrument, or data that is lost or destroyed.

Always turn the power off when the instrument is not in use.

When using a power adaptor, even when the power switch is in the "STANDBY" position, electricity is still flowing to the instrument at the minimum level. When you are not using the instrument for a long time, make sure you unplug the AC power adaptor from the wall AC outlet.

Make sure to discard used batteries according to local regulations.

- The illustrations and LCD screens as shown in this owner's manual are for instructional purposes only, and may be different from the ones on your instrument.
- Unless otherwise indicated, the example panel control illustrations, Keyboard illustrations and LCD screenshots are taken from the DGX-505.
- Please note that the DGX-505 and DGX-305 have different numbers of keys: the DGX-505 has 88 keys, and the DGX-305 has 76 keys.

● Trademarks

- The bitmap fonts used in this instrument have been provided by and are the property of Ricoh Co., Ltd.
- Windows is the registered trademark of Microsoft® Corporation.
- All other trademarks are the property of their respective holders.

Copyright Notice

The followings are the titles, credits and copyright notices for three (3) of the songs pre-installed in this electronic keyboard:

Don't Know Why

Words and Music by Jesse Harris
Copyright© 2002 Sony/ATV Songs LLC and Beany Songs
All Rights Administered by Sony/ATV Music Publishing, 8 Music Square West, Nashville, TN 37203
International Copyright Secured All Rights Reserved

My Favorite Things from THE SOUND OF MUSIC

Lyrics by Oscar Hammerstein II
Music by Richard Rodgers
Copyright© 1959 by Richard Rodgers and Oscar Hammerstein II
Copyright Renewed
WILLIAMSON MUSIC owner of publication and allied rights throughout the world
International Copyright Secured All Rights Reserved

Fly Me To The Moon (In Other Words)

Words and Music by Bart Howard
TRO - © Copyright 1954 (Renewed) Hampshire House Publishing Corp., New York, NY
International Copyright Secured
All Rights Reserved Including Public Performance For Profit
Used by Permission

All Rights Reserved, Unauthorized copying, public performance and broadcasting are strictly prohibited regarding the above three songs pre-installed.

COPYRIGHT NOTICE This product incorporates and bundles computer programs and contents in which Yamaha owns copyrights or with respect to which it has license to use others' copyrights. Such copyrighted materials include, without limitation, all computer software, styles files, MIDI files, WAVE data and sound recordings. Any unauthorized use of such programs and contents outside of personal use is not permitted under relevant laws. Any violation of copyright has legal consequences. **DON'T MAKE, DISTRIBUTE OR USE ILLEGAL COPIES.**

Copying of the commercially available software is strictly prohibited except for your personal use.

Panel logos



GM System Level 1

"GM System Level 1" is an addition to the MIDI standard which ensures that any GM-compatible music data can be accurately played by any GM-compatible tone generator, regardless of manufacturer. The GM mark is affixed to all software and hardware products that support GM System Level.



XGlite

As its name implies, "XGlite" is a simplified version of Yamaha's high-quality XG tone generation format. Naturally, you can play back any XG song data using an XGlite tone generator. However, keep in mind that some songs may play back differently compared to the original data, due to the reduced set of control parameters and effects.



XF

The Yamaha XF format enhances the SMF (Standard MIDI File) standard with greater functionality and open-ended expandability for the future. The instrument is capable of displaying lyrics when an XF file containing lyric data is played.



STYLE FILE

The Style File Format is Yamaha's original style file format which uses a unique conversion system to provide high-quality automatic accompaniment based on a wide range of chord types.



Smart Media™

This is a card-type medium for data storage. "SmartMedia" is a registered trademark of Toshiba Corporation. When used with an electronic musical instrument that features a card slot SmartMedia cards can be used to store and recall MIDI data and other types of data.



USB

USB is an abbreviation for Universal Serial Bus. It is a serial interface for connecting a computer with peripheral Devices. It allows "hot swapping" (connecting peripheral devices while the power to the computer is on).

*Congratulations and thank you for purchasing
the Yamaha DGX-505/305 Portable Grand!*

*Please read this owner's manual carefully before using the instrument,
in order to take full advantage of its various features.*

*Make sure to keep this manual in a safe and handy place even after you finish reading,
and refer to it often when you need to better understand an operation or function.*

Supplied Accessories

The DGX-505/305 package includes the following items. Please check that you have them all.

- Music rest
- Owner's manual (this book)
- Footswitch (DGX-505 only)
- Accessory CD-ROM
- Keyboard stand (DGX-505 only)

● About the Supplied CD-ROM

The following software which facilitates data transfer between a computer and the instrument is provided on the supplied CD-ROM. **This software is compatible with Windows operating systems only.**

- **USB driver**
- **Musicsoft Downloader**

The USB Driver enables data communication with the computer via USB. The Musicsoft Downloader application allows you to transfer songs downloaded from the Internet, as well as songs provided on the Accessory CD-ROM, to the instrument's flash memory or optionally-available SmartMedia card memory. For details refer to the Accessory CD-ROM Installation Guide (page 84) and to the online help provided for each program.

CAUTION

- *Never attempt to play the supplied CD-ROM on an audio CD player. Doing so can result in damage to your audio system and speakers, and potentially to your hearing!*

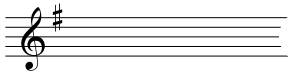

Special features of the DGX-505/305

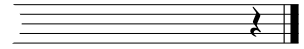

■ Performance assistant technology ▶ page 16

Play along with a song on the instrument's keyboard and produce a perfect performance every time ... even if you play wrong notes! All you have to do is play on the keyboard – alternately on the left- and right-hand ranges of the keyboard, for example – and you'll sound like a pro as long as you play in time with the music.

And if you can't play with both hands, you can still play the melody simply by tapping one key.

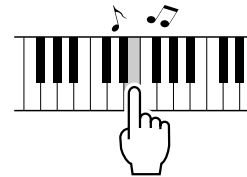

All you need is one finger!

■ Play a Variety Of Instrument Voices ▶ page 23

With the DGX-505/305, the instrument voice that sounds when you play the keyboard can be changed to violin, flute, harp, or any of an extensive range of voices. You can change the mood of a song written for piano, for example, by using violin to play it instead. Experience a whole new world of musical variety.



■ Learning music is fun ▶ page 39

This instrument includes a range of songs covering a variety of genres that are enjoyable to listen to, or to play along with. You can start practicing with just one hand, and you can even practice at your own tempo, one note at a time as slowly as you like, until you are able to play at full speed. Song playback will automatically follow your tempo. You can also use songs you have downloaded from the Internet for lessons, so your musical resources are essentially unlimited! The instrument will even evaluate and grade your performance for you!



■ Easy Performance with Music Notation Display ▶ page 37

When you play back a song, the corresponding score will be shown on the display as the song plays. This is a great way to learn how to read music. If the song contains lyric and chord data*, the lyrics and chords will also appear on the score display.

* No lyrics or chords will appear on the display if the song you are using with the score display function does not contain the appropriate lyric and chord data.

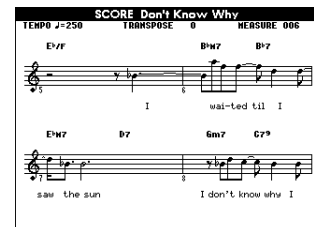

Contents

Copyright Notice	6
Panel logos	6
Supplied Accessories.....	7
Special features of the DGX-505/305	8
Setting Up	10
Power Requirements	10
Handling SmartMedia™ memory cards	11
Connecting headphones (PHONES/OUTPUT jack)	12
Connecting a footswitch (SUSTAIN JACK).....	12
Connecting to a computer (USB terminal)	12
Turn on the power.....	13
Panel Controls and Terminals	14
Front Panel	14
Rear Panel	15
Quick Guide	
The Easy Way To Play Piano	16
Chord Type – Play With Both Hands	16
Melody Type – Play With One Finger	18
Change the Song Tempo	21
Play the Demo Song	21
Changing the Display Language	22
Try Playing a Variety Of Instrument Voices	23
Select and Play a Voice – MAIN	23
Play Two Voices Simultaneously – DUAL	24
Play Different Voices With the Left and Right Hands – SPLIT	25
Play the Grand Piano Voice	27
Pitch Bend.....	27
Touch Response.....	27
Fun Sounds	28
Drum Kits	28
Sound Effects.....	28
Styles (Auto Accompaniment)	29
Play Along With Auto Accompaniment – STYLE	29
Harmony	31
A Variety Of Ways To Start and Stop Style Playback	33
Using Songs	35
Select and Listen To a Song	35
Types Of Songs	36
Displaying the Song Score.....	37
Display the Lyrics.....	38
Select a Song For a Lesson	39
Lesson 1: Waiting	39
Lesson 2: Your Tempo.....	41
Lesson 3: Minus One	42
Practice Makes Perfect – Repeat and Learn	42
Change a Song’s Style	43
Using the Easy Song Arranger	43
Record Your Own Performance	45
Track Configuration.....	45
Recording Procedure	46
Song Clear – Deleting User Songs	48
Track Clear – Deleting a Specified Track From a User Song	48
Backup and Initialization	49
Backup	49
Initialization	49
Basic Operation and Displays	50
Basic Operation	50
The Displays	52
MAIN Display Items	53

Reference

Handy Performance Features	54
Adding Reverb	54
Adding Chorus	55
The Metronome	56
Touch Response Sensitivity	57
One Touch Setting	57
Adjusting the Voice Parameters.....	58
Adjusting the Harmony Volume.....	58
Panel Sustain	58
Style (Auto-accompaniment) Functions	59
Setting the Split Point.....	59
Play Only the Style Rhythm	59
Play a Style With Chords but No Rhythm (Stop Accompaniment)	60
Adjusting the Style Volume	60
About Style Number 136	60
Playing Auto-accompaniment Chords.....	61
Looking Up Chords Using the Chord Dictionary	63
Song Settings	65
Song Volume.....	65
A-B Repeat.....	65
Muting Independent Song Parts.....	65
Change the Key Of a Song	66
Song Fast Forward, Fast Reverse, and Pause	66
Change the Melody Voice	67
Media Select	67
Memorize Your Favorite Panel Settings	68
Saving Settings to the Registration Memory	68
Function settings	70
Locating and Editing the Function Settings.....	70
Using SmartMedia™ Memory	73
Inserting a SmartMedia Card	73
Change the Media Select Setting to SmartMedia	74
Formatting SmartMedia Cards	74
Saving Data.....	75
Convert a User Song to SMF Format and Save	76
Loading Saved User data files	77
Deleting Data From a SmartMedia Card	77
Playing Songs Saved To SmartMedia	78
Save Your Easy Song Arranger Settings To SmartMedia	78
Connecting To a Computer	79
What Is MIDI?	79
USB Connection.....	80
MIDI Settings.....	80
MIDI (PC Mode) Settings For Computer Connection.....	81
Remote control of MIDI devices	81
Transferring Song Files From a Computer.....	82
Accessory CD-ROM Installation Guide	84
CD-ROM Contents	84
System Requirements.....	85
Software Installation.....	85
Appendix	
Troubleshooting	88
Messages	91
Keyboard Stand Assembly (DGX-505 Only)	93
Specifications	95
Voice List	96
Drum Kit List	100
Style List	102
Song List	103
Effect Type List	104
MIDI Implementation Chart	105
MIDI Data Format	106
Index	107



Setting Up

Make sure to do the following operations **BEFORE** turning on the power.

Power Requirements

Although the instrument will run either from an optional AC adaptor or batteries, Yamaha recommends use of an AC adaptor whenever possible. An AC adaptor is more environmentally friendly than batteries and does not deplete resources.

■ Using an AC Power Adaptor

- 1 Make sure that the [STANDBY/ON] switch of the instrument is set to STANDBY.

⚠ **WARNING**

- Use **ONLY** a Yamaha PA-5D, PA-5C AC Power Adaptor (or other adaptor specifically recommended by Yamaha) to power your instrument from the AC mains. The use of other adaptors may result in irreparable damage to both the adaptor and the instrument.

- 2 Connect the AC adaptor (PA-5D, PA-5C or other adaptor specifically recommended by Yamaha) to the power supply jack.

- 3 Plug the AC adaptor into an AC outlet.

⚠ **CAUTION**

- Unplug the AC Power Adaptor when not using the instrument, or during electrical storms.

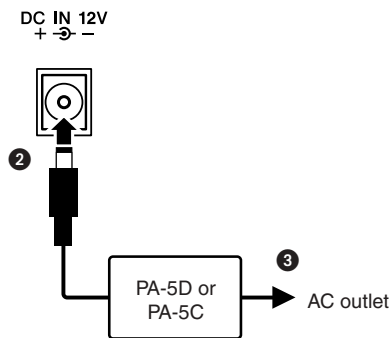

■ Using Batteries

- 1 Open the battery compartment cover located on the instrument's bottom panel.
- 2 Insert the six new batteries, being careful to follow the polarity markings on the inside of the compartment.
- 3 Replace the compartment cover, making sure that it locks firmly in place.

NOTE

- Connecting the AC power adaptor automatically supplies power from the adaptor and overrides battery power, even when batteries are installed.

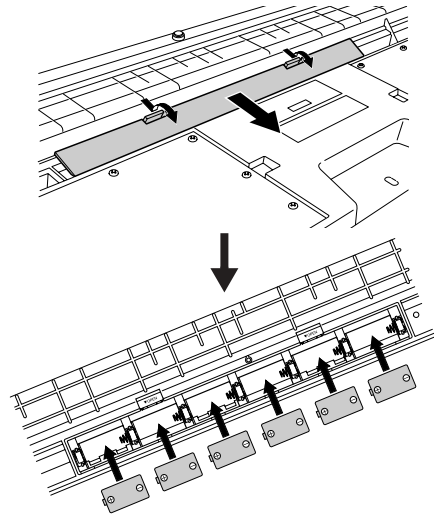

For battery operation the instrument requires six 1.5V "D" size, R20P (LR20) or equivalent batteries. (Alkaline batteries are recommended.) When battery power becomes too low for proper operation, a "LOW BATTERY!!" message flashes in the upper right of the display. As soon as this message appears, make sure to replace all batteries, following the precautions listed below.

If necessary, also make sure to save all important User data (see pages 49 and 75), since custom panel settings are lost when the batteries are removed.

⚠ **CAUTION**

- Use only manganese or alkaline batteries for this instrument. Other types of batteries (including rechargeable batteries) may have sudden drops of power when battery power becomes low, possibly resulting in loss of data in the flash memory / SmartMedia™ card and the need to re-format the card.
- Make sure to install the batteries in the same direction, maintaining the correct polarity (as shown). Incorrect battery installation may result in heat, fire and/or leaking of corrosive chemicals.
- When the batteries run down, replace them with a complete set of six new batteries. NEVER mix old and new batteries. Do not use different kinds of batteries (e.g. alkaline and manganese) at the same time.
- If the instrument is not to be in use for a long time, remove the batteries from it, in order to prevent possible fluid leakage from the battery.
- Please use the power adaptor when transferring data to SmartMedia or flash memory. Batteries (including rechargeable types) can be drained rapidly by this type of operation. If the batteries do become drained during a data transfer, both the data being transferred and the data currently in the transfer destination will be lost.

⚠ **CAUTION**

- Don't open the battery compartment cover while the instrument is resting on the keyboard stand. The batteries can fall out of the battery compartment and possibly cause damage. Always turn the instrument over before opening the battery compartment cover.

■ Handling SmartMedia™* memory cards

* SmartMedia is a trademark of Toshiba Corporation.

This instrument features a built-in SmartMedia card slot (on the front panel). It lets you save original data you've created on the instrument to a SmartMedia card, and allows you to load data from a card to the instrument. Be sure to handle SmartMedia cards with care. Follow the important precautions below.

● Compatible SmartMedia types

- 3.3V (3V) SmartMedia can be used. 5V type SmartMedia is not compatible with this instrument.
- SmartMedia cards of five different memory capacities of (8MB, 16MB, 32MB, 64MB, and 128MB) can be used with the instrument. SmartMedia cards greater than 32MB can be used if they conform to the SSFDC Forum standard.

NOTE

- *SSFDC is an abbreviation for Solid State Floppy Disk Card (another name for SmartMedia cards). The SSFDC Forum is a voluntary organization established for the promotion of SmartMedia.*

● Formatting SmartMedia cards

- If you find that you are unable to use new, blank SmartMedia cards or cards that have been used with other devices, you may need to format them. For details on how to format a SmartMedia card, see page 74. Keep in mind that all data on the card will be lost after formatting. Make sure to check beforehand whether or not the card contains important data.

NOTE

- *SmartMedia cards formatted on this device may or may not be useable as is on other devices.*

● Inserting/removing SmartMedia cards

Inserting SmartMedia cards

- Insert the SmartMedia card with the terminal (gold-plated) side face up into the card slot, until it fits into place.
- Do not insert the SmartMedia card in the wrong direction.
- Do not insert anything other than a SmartMedia card in the slot.

Removing SmartMedia cards

- Before removing the SmartMedia card, be sure to confirm that the card is not in use, or it is not being accessed by the instrument. Then pull the card out slowly by hand. If the SmartMedia card is being accessed*, a message indicating that it is in use appears on the instrument's display.

* Accessing includes saving, loading, formatting, deleting and making directory. Also, be aware that the instrument will automatically access the SmartMedia to check the media type when it is inserted while the instrument is turned on.

CAUTION

- *Never attempt to remove the SmartMedia card or turn the power off during accessing. Doing so can damage the data on the instrument or card and possibly damage the SmartMedia card itself.*

● About SmartMedia cards

Handle SmartMedia cards with care, and follow these precautions:

- There are times when static electricity affects SmartMedia. Before you touch a SmartMedia card, touch something metallic such as a door knob and aluminum sash, to reduce the possibility of static electricity.
- Be sure to remove the SmartMedia card from the SmartMedia slot when it is not in use for a long time.
- Do not expose the SmartMedia to direct sunlight, extremely high or low temperatures, or excessive humidity, dust or liquids.
- Do not place heavy objects on a SmartMedia card or bend or apply pressure to the card in any way.
- Do not touch the gold-plated terminals of the SmartMedia card or put any metallic plate onto the terminals.
- Do not expose the SmartMedia card to magnetic fields, such as those produced by televisions, speakers, motors, etc., since magnetic fields can partially or completely erase data on the SmartMedia, rendering it unreadable.
- Do not attach anything other than the provided labels to a SmartMedia. Also make sure that labels are attached in the proper location.

To protect your data (write-protect):

- To prevent inadvertent erasure of important data, affix the write-protect seal (provided in the SmartMedia package) onto the designated area (within the circle) of the SmartMedia card. Conversely, to save data on the SmartMedia card, make sure to remove the write-protect seal from the card.
- Do not reuse a seal that has been peeled off.

Data Backup

- For maximum data security, Yamaha recommends that you keep two copies of important data on separate SmartMedia cards. This gives you a backup if one card is lost or damaged.

Make all necessary connections below **BEFORE** turning the power on.

Connecting headphones (PHONES/OUTPUT jack)

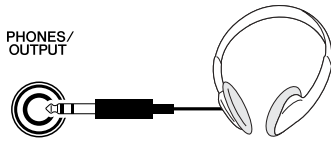

The DGX-505/305 speakers are automatically shut off when a plug is inserted into this jack.

The PHONES/OUTPUT jack also functions as an external output.

You can connect the PHONES/OUTPUT jack to a keyboard amplifier, stereo system, mixer, tape recorder, or other line-level audio device to send the instrument's output signal to that device.

WARNING

- Avoid listening with the headphones at high volume for long periods of time; doing so may not only result in ear fatigue, it may be damaging to your hearing.

CAUTION

- To prevent damage to the speakers, set the volume of the external devices at the minimum setting before connecting them. Failure to observe these cautions may result in electric shock or equipment damage. Also, be sure to set the volumes of all devices at their minimum levels and gradually raise the volume controls while playing the instrument to set the desired listening level.

Connecting a footswitch (SUSTAIN JACK)

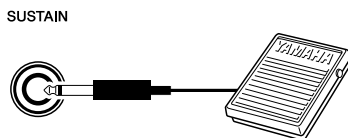

The sustain function lets you produce a natural sustain as you play by pressing a footswitch. Plug the Yamaha FC4 or FC5 footswitch into this jack and use it to switch sustain on and off.

An FC5 footswitch is supplied with the DGX-505. DGX-305 owners can purchase an FC5 separately if footswitch functionality is required.

NOTE

- Make sure that the footswitch plug is properly connected to the SUSTAIN jack before turning on the power.
- Do not press the footswitch while turning the power on. Doing this changes the recognized polarity of the footswitch, resulting in reversed footswitch operation.

Connecting to a computer (USB terminal)

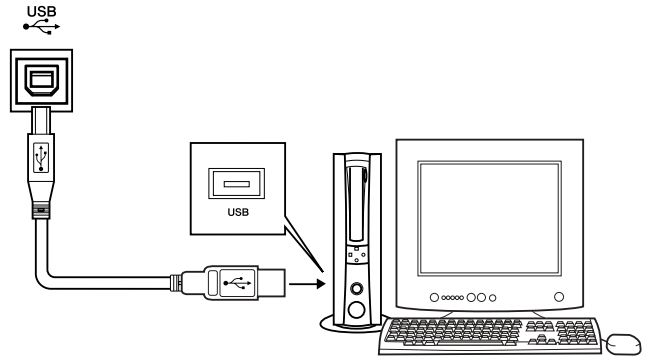

Connect the instrument's USB terminal to the USB terminal of a computer, and you can transfer performance data and song files between the two (page 80).

To use the USB data-transfer features you'll need to do the following:

- Connect the USB terminal of the computer to the USB terminal on the instrument using a standard USB cable.
- Install the USB MIDI driver on your computer.

Installation of the USB MIDI driver is described on page 85.

With this capability you can, for example, use the Musicsoft Downloader software provided on the supplied CD-ROM to transfer songs from your computer to the instrument's SmartMedia or flash memory.

NOTE

- Make sure to purchase a quality USB cable at a musical instrument store, computer store or electrical appliance store.

Turn on the power

Turn down the volume by turning the [MASTER VOLUME] control to the left and press the [STANDBY/ON] switch to turn on the power. Pressing the switch again turns the power off.

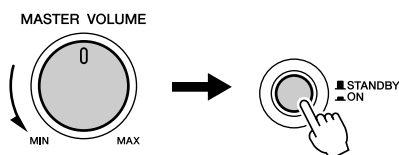

Backup data in the flash memory (page 49) is loaded to the instrument when the power is turned on. If no backup data exists on flash memory, all instrument settings are restored to the initial factory defaults when the power is turned on.

CAUTION

- Even when the switch is in the “STANDBY” position, electricity is still flowing to the instrument at the minimum level. When you are not using the instrument for a long time, make sure you unplug the AC power adaptor from the wall AC outlet, and/or remove the batteries from the instrument.

CAUTION

- Never attempt to turn off the power during writing, otherwise the data on the instrument may be damaged or lost.

● Music Rest

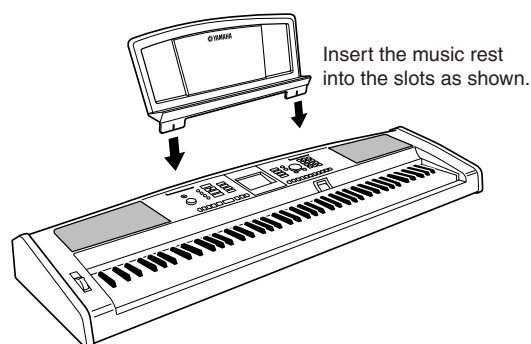



Panel Controls and Terminals

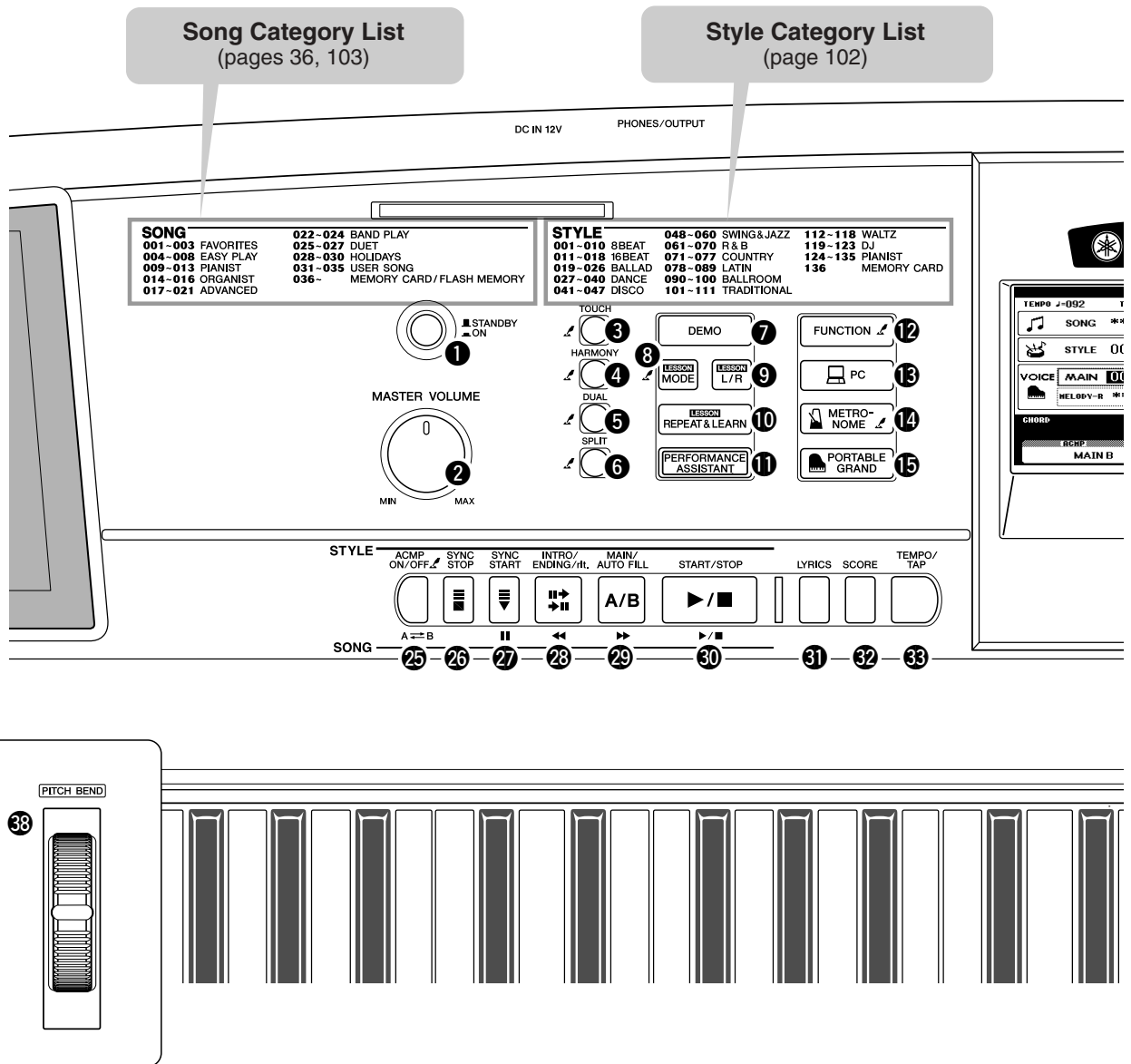

■ Front Panel

- 1 [STANDBY/ON] switch..... page 13
- 2 [MASTER VOLUME] control..... pages 13, 17
- 3 [TOUCH] button page 57
- 4 [HARMONY] button page 31
- 5 [DUAL] button page 24
- 6 [SPLIT] button page 25
- 7 [DEMO] button page 21
- 8 [LESSON MODE] button page 40
- 9 [LESSON L/R] button page 39
- 10 [LESSON REPEAT & LEARN] button page 42
- 11 [PERFORMANCE ASSISTANT] button..... page 16
- 12 [FUNCTION] button pages 52, 70
- 13 [PC] button page 81
- 14 [METRONOME] button page 56
- 15 [PORTABLE GRAND] button page 27
- 16 [SONG] button page 35
- 17 [EASY SONG ARRANGER] button..... page 43
- 18 [STYLE] button page 29
- 19 [VOICE] button page 23
- 20 [FILE CONTROL] button page 74
- 21 [EXECUTE] button..... page 74
- 22 Dial..... pages 51, 70
- 23 CATEGORY buttons [▲], [▼]..... pages 51, 70
- 24 Number buttons [0] – [9],
[+] and [-] buttons..... pages 51, 70
- 25 [ACMP ON/OFF] / [A ⇄ B] button pages 29, 65
- 26 [SYNC STOP] button page 33
- 27 [SYNC START] / [II] button..... pages 30, 66

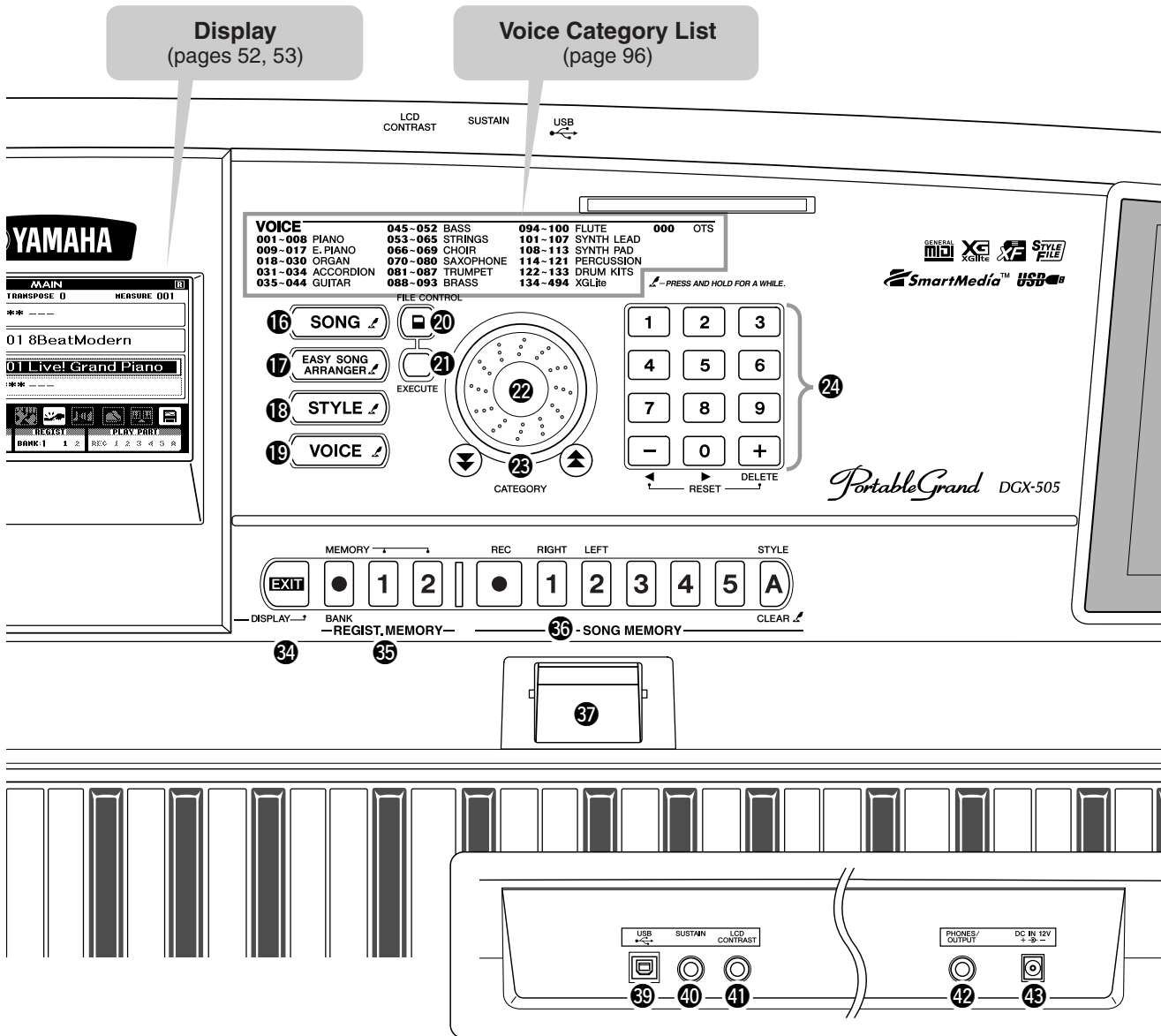

■ Rear Panel

- 28 [INTRO/ENDING/rit.] / [◀◀] button pages 30, 66
- 29 [MAIN/AUTO FILL] / [▶▶] button pages 31, 66
- 30 [START/STOP] / [▶/■] button pages 29, 35, 51
- 31 [LYRICS] button page 38
- 32 [SCORE] button page 37
- 33 [TEMPO/TAP] button page 21
- 34 [EXIT] button page 52
- 35 REGIST. MEMORY
[●] (MEMORY/BANK), [1], [2] buttons page 68
- 36 SONG MEMORY
[REC], [1] – [5], [A] buttons page 46
- 37 Card Slot (for SmartMedia) pages 11, 73
- 38 [PITCH BEND] wheel page 27
- 39 USB terminal pages 12, 80
- 40 SUSTAIN jack page 12
- 41 [LCD CONTRAST] knob page 53
- 42 PHONES/OUTPUT jack page 12
- 43 DC IN 12V jack page 10



The Easy Way To Play Piano

This instrument includes a performance assistant technology feature that lets you play along with a song and sound like a great pianist (even though you might be making lots of mistakes)! In fact, you can play any notes and still sound good! You could even just tap one key and the results would be a beautiful melody. So even if you can't play piano and can't read a note of music, you can have some musical fun.

The performance assistant technology has two types – Chord and Melody.

- **Chord** Select this type when you want to play with both hands. You'll get beautifully arranged sound no matter what you play.
- **Melody**..... This type lets you play the melody with just one finger.

Try the Chord type to begin with, and then try the Melody type. The secret to the performance assistant technology's ability to turn random playing into music is divulged on page 20. Enjoy the feature for a while first, then read about how its done.

Chord Type – Play With Both Hands

To use the performance assistant technology Chord type you must be playing a song that includes chord data.

1 Press the [SONG] button.

The song number and name will be highlighted. When the song is highlighted on the display you can use the dial or other selection controls to select a different song.

NOTE
• For details on Chords, see page 64.



The song is highlighted. The number and name of the currently selected song is displayed here.

2 Select a song.

Rotate the dial and watch the highlighted song names – for this example we'll select song "026 Twinkle Star."

NOTE
• MIDI songs included on the supplied Accessory CD-ROM can also be transferred to the instrument and used with the performance assistant technology.

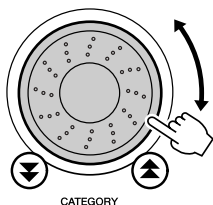

The song displayed here will be played.

3 Press the [PERFORMANCE ASSISTANT] button.

The PERFORMANCE ASSISTANT display will appear. The display includes icons that show whether the performance assistant technology is on or off, and whether the chord or melody type is selected. Press the [PERFORMANCE ASSISTANT] button to turn the function on or off. Use the [+] and [-] buttons to select the chord or melody type.

PERFORMANCE ASSISTANT

CHORD TIMING [Flashing Indicator]

SONG 026 Twinkle Star

ON/OFF [ON]

TYPE [CHORD]

The indicator flashes in response to the song chord data.

ON/OFF
ON/OFF "ON" will appear when the performance assistant technology is on. Pressing the [PERFORMANCE ASSISTANT] button alternates between "ON" and "OFF." Make sure this is "ON" when you intend to use the performance assistant technology.

TYPE
The currently selected type is shown. The [-] button selects the CHORD type and the [+] button selects the MELODY type. The graphic knob in the display will indicate the selected setting.

4 Press the [START/STOP] button.

Song playback will begin.

Use the [MASTER VOLUME] control to adjust the overall volume.

STYLE ACMP ON/OFF SYNC STOP SYNC START INTRO/ENDING/Alt. MAIN/AUTO FILL START/STOP

SONG A=B II << >> >|

MASTER VOLUME

Adjust volume

5 Play on the keyboard.

To begin, try to feel the rhythm of the song. Then, with your hands spread as shown in the illustration, simply play the keyboard alternately with your left and right hands (any notes will do).

Sounds like you're playing the right notes!

You will get even better results if you match your left-hand rhythm to rhythm of the cord indicator in the display.

How does it sound? You'll get acceptable results no matter where you play thanks to the performance assistant technology Chord type!

Next try the three playing methods illustrated below. Different ways of playing produce different results.

- Play with the left and right hands at the same timing – type 1.

Play 3 notes at once with your right hand.
- Play with the left and right hands at the same timing – type 2.

Play 1 note at a time with your right hand (for example: index finger → middle finger → ring finger).
- Play alternately with the left and right hands – type 3.

Play 3 notes at once with your right hand.

Once you get a feel for it, try playing chords with your left hand and a melody with your right ... or any other combination.

Song playback will stop automatically when the song has played all the way through.

You can also stop playback at any time by pressing the [START/STOP] button.

Melody Type – Play With One Finger

Using the same song, try playing the melody with just one finger.

To use the performance assistant technology Melody type you must be playing a song that includes melody data.

- 1** • If you've completed the steps on the preceding pages, go straight to step 2 below.
- If you want to use the Melody before the Chord type, carry out steps 1 – 3 on page 16 and then continue from step 2 below.

NOTE

- Press the [EXIT] button if you want to return to the MAIN display.

2 Press the [+] button.

This switches to the performance assistant technology Melody type. The graphic knob in the display will rotate to indicate the new setting. Make sure the ON/OFF icon is set to ON.

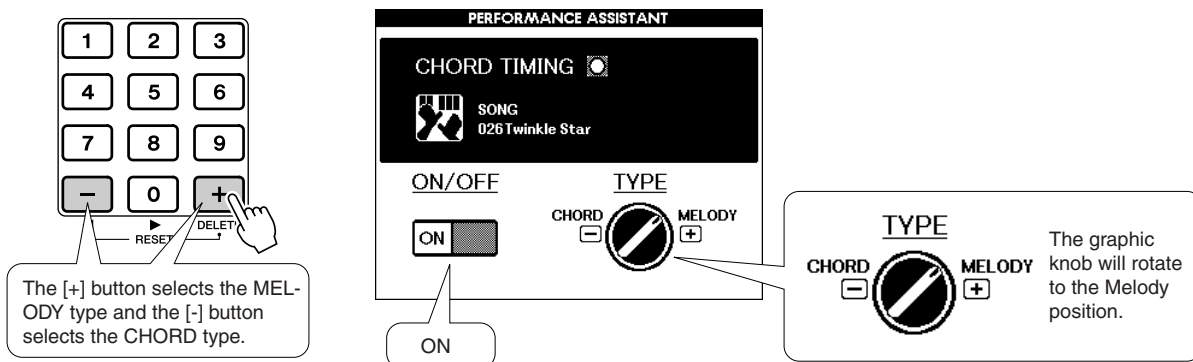

3 Press the [START/STOP] button.

Because the Melody type has been selected, the song melody will not sound. You can enjoy playing the melody yourself (step 4).



4 Play on the keyboard.

To begin, try to feel the rhythm of the song. Then tap a key with one finger of your right hand in time with the music. You can play any key.

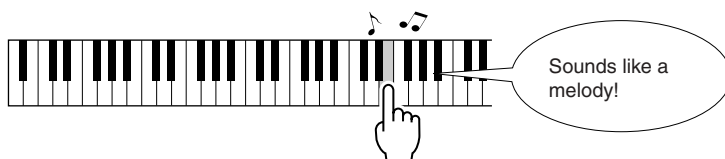

How does it sound? You've played the melody using only one finger thanks to the performance assistant technology Melody type!

Song playback will stop automatically when the song has played all the way through.

You can also stop playback at any time by pressing the [START/STOP] button.

When you want to end the performance assistant technology type press the [PERFORMANCE ASSISTANT] button.

Make Use Of the Score In the Melody Type

If you want to play the melody with the correct rhythm or play ad-lib lines, use the on-screen score feature.

Displaying the Score

After performing steps 1 – 3 on the previous page, press the [SCORE] button. The melody score will appear.

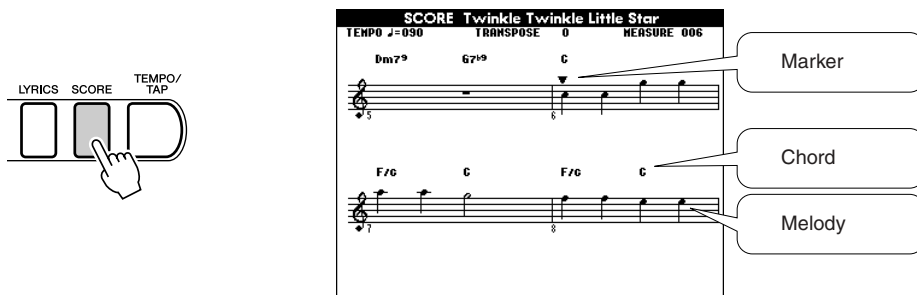

■ The Score Is Handy When ...

● You Want To Play With the Correct Rhythm

Use the score when you're playing a melody you're not familiar with. The marker will indicate the current position in the score during playback. If you play a key each time the marker appears above a note in the score you will be able to play the melody with the correct "original" rhythm.

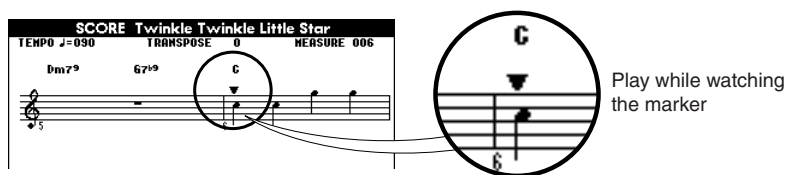

● You Want To Play Jazzy Ad-lib Lines

When you are using the performance assistant technology Melody type and you play on the keyboard during breaks in the melody, jazzy* ad-lib phrases will automatically be created. For example, measures 048 through 055 of the song ("001 Don't Know Why") are a break in the melody. Try creating interesting ad-lib phrases during the breaks.

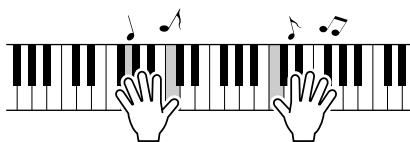

* Playing With a Jazz Feel

You can play any keys you like. Begin by playing one note at a time with the right-hand fingers in sequence: thumb → index → middle. Then play a simple scale (ex: do-re-mi ...) including black keys while adding dynamic variation. When you get used to playing like this try adding your left hand. Play chords (multiple notes) with the left hand in the spaces between what the right hand is playing.

You can stop song playback at any time by pressing the [START/STOP] button.

NOTE

• Jazz Rhythm

The term "jazz rhythm" usually refers to a light-hearted swinging rhythm. Here's a written explanation.

Straight rhythm:

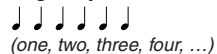

A more jazzy rhythm:

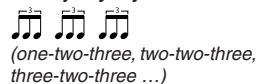

Most jazz rhythms have a "triplet" feel like the last one above. Keep this feel in mind while playing your jazz ad-lib phrases!

— The Secret Of the performance assistant technology — How It Creates Music From Random Notes

When you use the Chord type, the performance assistant technology reads the chord data from the song and only assigns notes that will “work” at that moment to the keyboard. In the Melody type it reads the song’s melody data and assigns the appropriate note(s) to the key(s) you play, so you can play the melody by playing any keys. Going back to the Chord type, since the chords of a song are constantly changing, different notes and chords will be produced even if you repeatedly play the same keys.

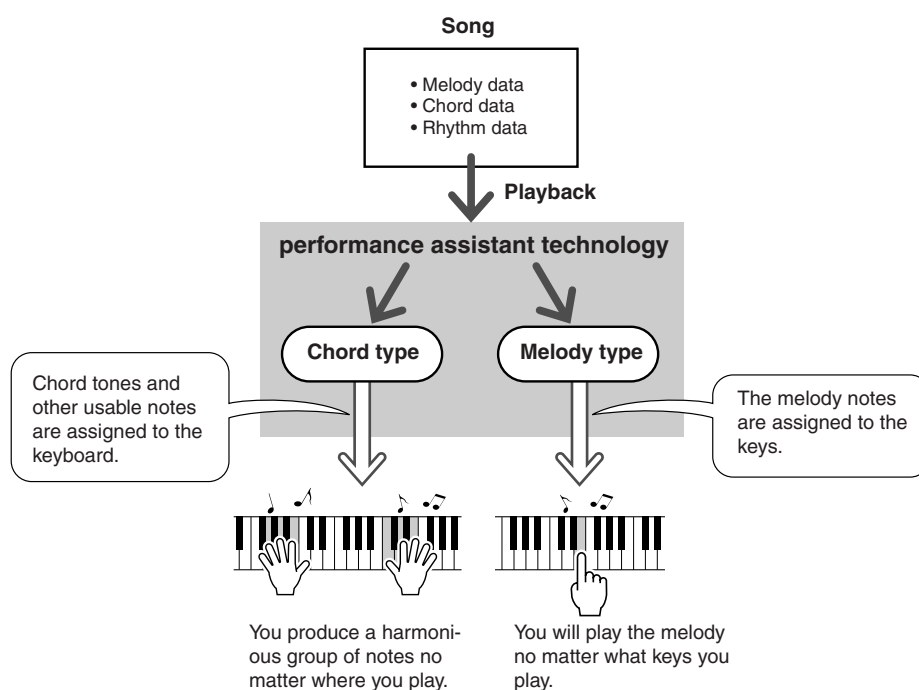

● Songs That Can Be Used With the performance assistant technology

When the Chord type is selected the performance assistant technology can only be used with songs that include chord data. In the same way, when the Melody type is selected the performance assistant technology will only work with songs that include melody data. In order to find out if a song includes the required data, first select the song and then press the [SCORE] button. If chords appear on the display (page 19) when you press the [SCORE] button you can use the Chord type. If the melody appears on the display (page 19) when you press the [SCORE] button you can use the melody type.

● External Songs and the performance assistant technology

In addition to the instrument’s internal songs, the 70 songs provided on the Accessory CD-ROM (page 84) can be used with the performance assistant technology. A list of the MIDI songs included on the Accessory CD-ROM is provided on page 103.

Songs downloaded from the Internet can also be used with the performance assistant technology as long as they include the required chord and/or melody data. Transfer song files you want to use from your computer to the instrument’s flash memory or an optional SmartMedia memory card (page 82).

Change the Song Tempo

When using the performance assistant technology or in other situations in which the tempo of the song is too fast or too slow for you, you can change the tempo as required. Press the [TEMPO/TAP] button. The tempo display will appear and you can use the dial, the [+] and [-] buttons, or the [0] – [9] number buttons to set the tempo to anywhere from 032 and 280 quarter-note beats per minute.

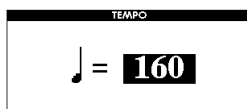
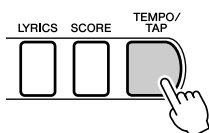

You can also set the tempo by simply tapping the [TEMPO/TAP] button at the required tempo – 4 times for time signatures in 4, and three times for time signatures in 3. You can change the tempo during song playback by pressing the button just twice.

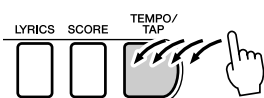

You can return to the original tempo by simultaneously pressing the [+] and [-] buttons. When you're done with the tempo setting press [EXIT] twice to return to the MAIN display.

Play the Demo Song

You can use the performance assistant technology Chord type with the demo song (the Melody type cannot be used).

1 Press the [DEMO] button.

The demo display that introduces some of the instrument's features will appear, and the demo song will start playing. Listen to some of the outstanding instrument voices provided!

2 Try playing the keyboard.

The following display will appear after the demo song has been playing for a while.

This indicates that the performance assistant technology feature is now ON, and you can start playing along on the keyboard.

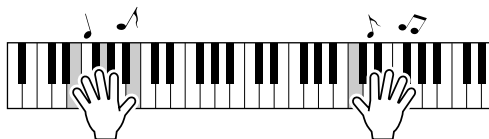

NOTE

- The default language for the display is English, but you can also switch to Japanese – see page 22. The change will take effect the next time to select the demo display.

After a little while, the performance assistant technology feature will automatically be OFF, which is indicated on the display.

The demo song will automatically repeat from the beginning after it has played all the way through.

You can stop demo playback at any time by pressing the [START/STOP] button.

Changing the Display Language

This instrument allows you to select English or Japanese as the display language. The default display language is English, but if you switch to Japanese the lyrics, file names, demo display, and some messages will be displayed in Japanese where appropriate.

1 Press the [FUNCTION] button.

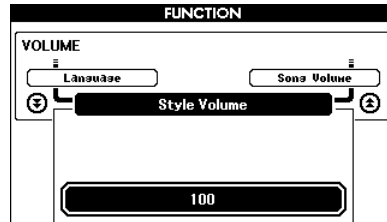
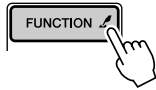

2 Press a CATEGORY button a number of times until the "Language" item appears.

The currently selected display language will appear below the "Language" item. When highlighted you can use the [+] and [-] buttons to select the language as required.

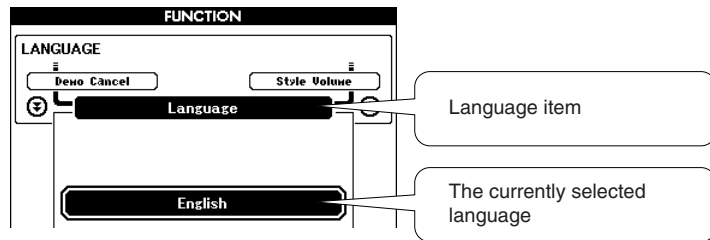
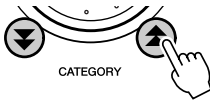

3 Select a display language.

The [+] button selects English and the [-] button selects Japanese. If you switch to Japanese, lyrics, file names, demo display, and some message will be displayed in Japanese where appropriate. Other displays will be in English.

4 Press and hold the [FUNCTION] button for longer than a second.

The language selection will be stored in the internal flash memory so that it is retained even when the power is turned off.

5 Press [EXIT] to return to the MAIN display.

Try Playing a Variety Of Instrument Voices

In addition to piano, organ, and other “standard” keyboard instruments, this instrument has a large range of voices that includes guitar, bass, strings, sax, trumpet, drums and percussion, sound effects ... a wide variety of musical sounds.

Select and Play a Voice – MAIN

This procedure selects the main voice you will play on the keyboard. In DGX-505/305 terminology this voice is known as the “main voice.”

1 Press the [VOICE] button.

The VOICE-MAIN voice number and name in the MAIN display will be highlighted. You can now use the dial or other selection controls to select a different voice.

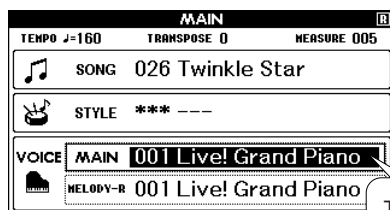

The VOICE-MAIN voice number and name will be highlighted. The currently selected voice is shown.

NOTE

- If you press and hold the [VOICE] button for longer than a second a voice list will appear. You can then select the main voice from the voice list.

2 Select the voice you want to play.

While watching the highlighted voice name rotate the dial. The available voices will be selected and displayed in sequence. The voice selected here becomes the main voice.

For this example select the 096 Flute voice.

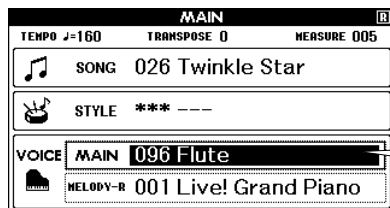
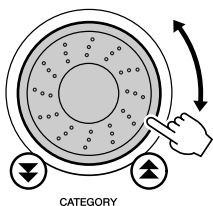

Select 096 Flute

3 Play the keyboard.

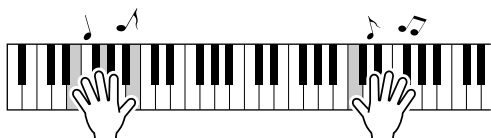

Try selecting and playing a variety of voices.

Play Two Voices Simultaneously – DUAL

You can select a second voice which will play in addition to the main voice when you play the keyboard. The second voice is known as the “dual” voice.

1 Press the [DUAL] button.

The [DUAL] button turns the dual voice on or off.

When turned on the dual voice icon will appear in the display. The currently selected dual voice will sound in addition to the main voice when you play the keyboard.

NOTE

- The dual voice feature cannot be used during a song lesson (page 39).

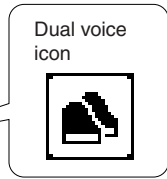
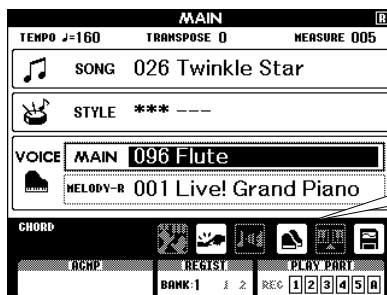
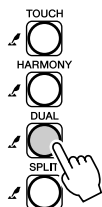

2 Press and hold the [VOICE] button for longer than a second.

Hold the [VOICE] button until a voice list like the one shown below appears.



Hold for longer than a second

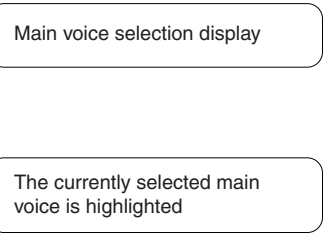
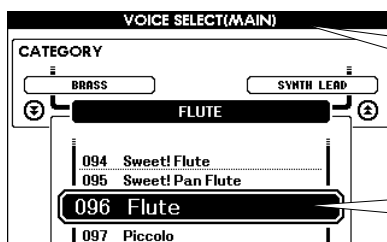

3 Press the [VOICE] button again.

The dual voice selection display will appear.

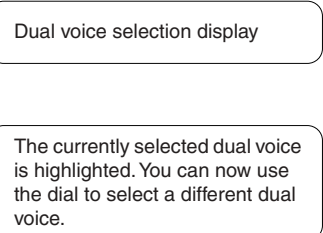
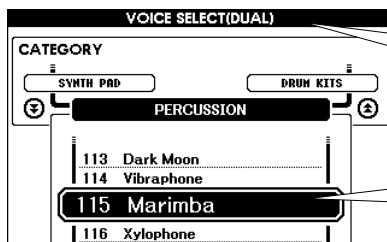

4 Select the desired dual voice.

Watch the highlighted dual voice and rotate the dial until the voice you want to use is selected. The voice selected here becomes the dual voice.

For this example try selecting the 114 Vibraphone voice.

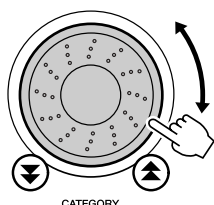

5 Play the keyboard.

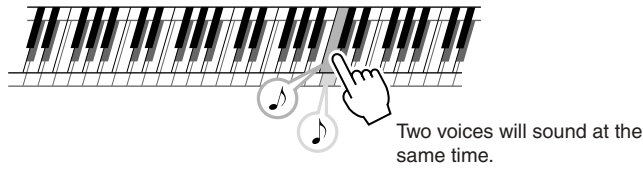

Try selecting and playing a range of dual voices.

Press [EXIT] button to return to the MAIN display.

Play Different Voices With the Left and Right Hands – SPLIT

In the split mode you can play different voices to the left and right of the keyboard “split point.” The main and dual voices can be played to the right of the split point, while the voice played to the left of the split point is known as the “split voice” in the DGX-505/305. The split point setting can be changed as required (page 59).

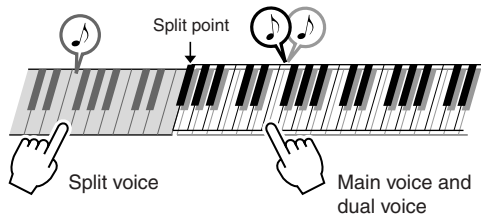

1 Press the [SPLIT] button.

The [SPLIT] button turns the split voice on or off.

When turned on the split voice icon will appear in the display. The currently selected split voice will sound to the left of the keyboard split point.

NOTE

- The split voice feature cannot be used during a song lesson (page 39).

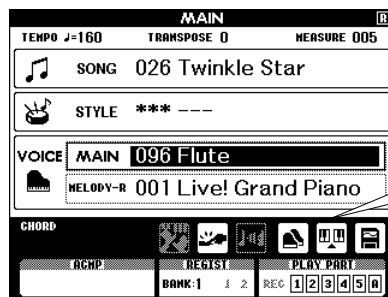
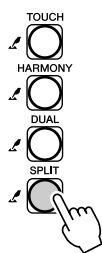

2 Press and hold the [VOICE] button for longer than a second.

Hold the [VOICE] button until a voice list like the one shown below appears.



Hold for longer than a second

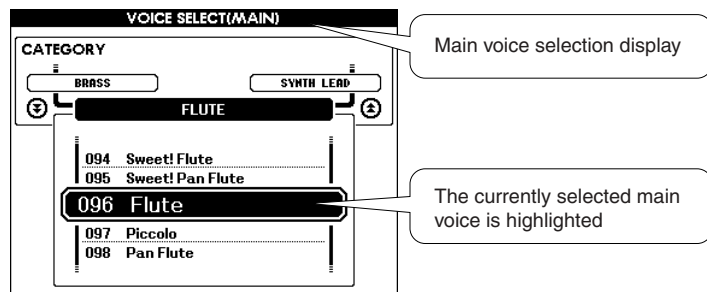

3 Press the [VOICE] button twice more.

The split voice selection display will appear. The split voice will be highlighted so that you can use the dial to select a different split voice.

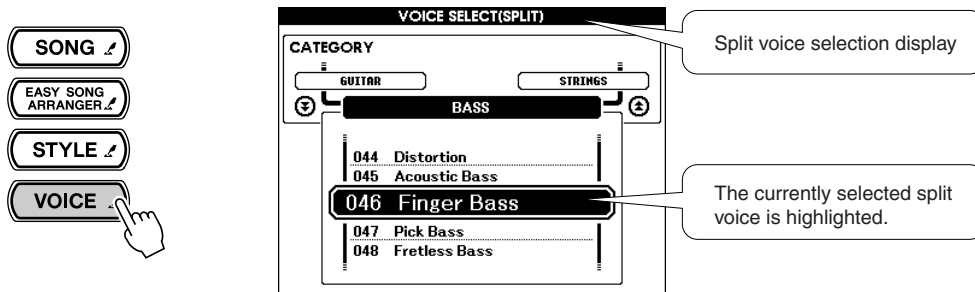

4 Select the desired split voice.

Watch the highlighted split voice and rotate the dial until the voice you want to use is selected. The voice selected here becomes the split voice which will play to the left of the keyboard split point. For this example try selecting the 036 Folk Guitar voice.

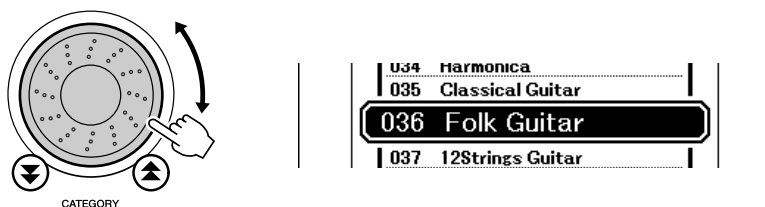

5 Play the keyboard.

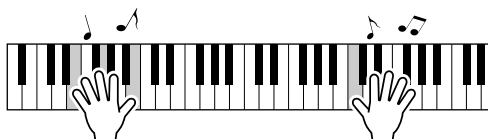

Try selecting and playing a range of split voices.

Press [EXIT] button to return to the MAIN display.

Play the Grand Piano Voice

When you just want to play piano, all you have to do is press one convenient button.

Press the [PORTABLE GRAND] button.

The “001 Live! Grand Piano” voice will be selected.



NOTE

- When you press the [PORTABLE GRAND] button all settings other than touch sensitivity are turned off. The dual and split voices will also be turned off, so only the Grand Piano voice will play over the entire keyboard.

Pitch Bend

The pitch bend wheel can be used to add smooth pitch variations to notes you play on the keyboard. Roll the wheel upward to raise the pitch, or downward to lower the pitch.

If you use this feature with a voice such as the “043 Overdriven” guitar voice (page 23), you can produce remarkably realistic string-bending effects.

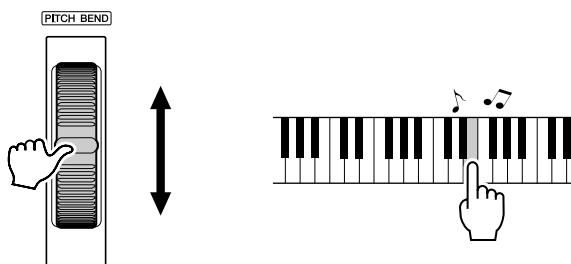

Touch Response

When touch response is on you can control the volume of notes according to how hard you play the keys – much like a real piano responds to subtle touch nuances. When touch response is off the same volume will be produced no matter how hard you play the keys.

Press the [TOUCH] button.

The [TOUCH] button turns touch response on or off. Touch response is normally on. When touch response is on the touch response icon will appear in the display.



NOTE

- Touch response sensitivity can be adjusted in three steps – page 57.



Fun Sounds

This instrument includes a range of drum kits and unique sound effects you can use for entertainment. Laughter, babbling brooks, jet fly-bys, eerie effects, and much more. These sounds can be a great way to enhance the mood at parties.

Drum Kits

Drum kits are collections of drum and percussion instruments. When you select a violin or other normal instrument main voice, for example, all keys produce the sound of the same violin, only at different pitches. If you select a drum kit as the main voice, however, each key produces the sound of a different drum or percussion instrument.

◆ Drum Kit Selection Procedure → (refer to steps 1 and 2 on page 23)

- 1** Press the [VOICE] button from the MAIN display.
- 2** Use the dial to select “122 Standard Kit 1”.
- 3** Try out each key and enjoy the drum and percussion sounds!

Don't forget the black keys! You'll hear a triangle, maracas, bongos, drums ... a comprehensive variety of drum and percussion sounds. For details on the instruments included in the drum kit voices (voice numbers 122 – 133), see the “Drum kit List” on page 100.

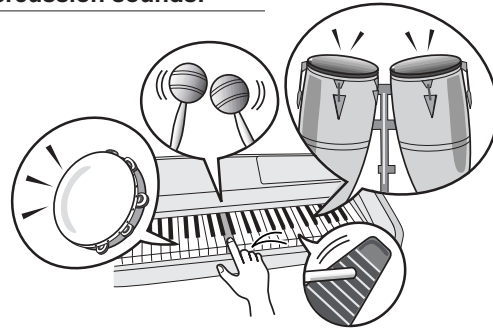

Sound Effects

The sound effects are included in the drum kit voice group (voice numbers 132 and 133). When either of these voices are selected you will be able to play a range of sound effects on the keyboard.

◆ Sound Effect Selection Procedure → (refer to steps 1 and 2 on page 23)

- 1** Press the [VOICE] button from the MAIN display.
- 2** Use the dial to select “133 SFX Kit 2”.
- 3** Try out each key and enjoy the sound effects!

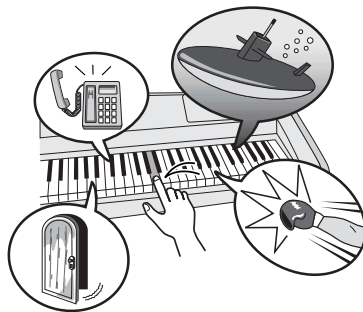

As you try out the various keys you'll hear the sound of a submarine, a telephone bell, a creaking door, and many other useful effects. “132 SFX Kit 1” includes lightning, running water, laughter, dogs barking, and others. Some keys do not have assigned sound effects, and will therefore produce no sound. For details on the instruments included in the SFX kit voices (voice numbers 132 – 133), see “SFX Kit 1” and “SFX Kit 2” in the “Drum kit List” on page 100.





Styles (Auto Accompaniment)

This instrument includes an auto-accompaniment feature that plays appropriate “styles” (rhythm + bass + chord accompaniment) when you play left-hand chords. 135 different styles covering a wide range of musical genres are provided (see page 102 for a complete style list). Here’s how you can use the auto-accompaniment feature.

Play Along With Auto Accompaniment – STYLE

1 Press the [STYLE] button.

The current style number and name will be highlighted. You can now use the dial to select the desired style.

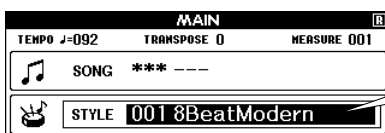

The currently selected style number and name is displayed here.

2 Select a style.

Use the dial to select a style. For this example try selecting the “080 PopBossa” style.

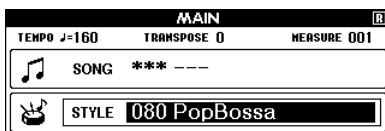
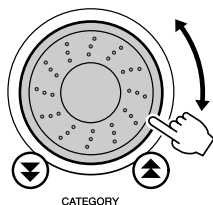

3 Press the [START/STOP] button.

Rhythm-only playback of the selected style will begin.

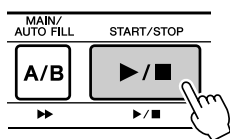

Style rhythm start!

NOTE

- Since style number 112 and the pianist category styles (124 – 135) have no rhythm parts, no sound will be produced if you start rhythm-only playback. To use these styles turn the auto-accompaniment and play on the keyboard as described on page 33 (the bass and chord accompaniment parts will sound).

4 Press the [START/STOP] button again.

The style rhythm will stop.

5 Press the [ACMP ON/OFF] button.

This turns auto-accompaniment on. Check that “ACMP” appears in the display.

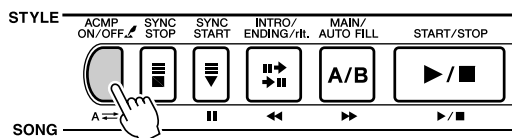

“ACMP” appears when auto-accompaniment is on.

NOTE

- If “ACMP” is not showing in the display press the [ACMP ON/OFF] button so that it appears. The [ACMP ON/OFF] button alternately turns auto-accompaniment on and off.

● **When Auto-accompaniment Is On ...**

The left-hand section of the keyboard becomes the “accompaniment range” in which you will play the chords that define the accompaniment.

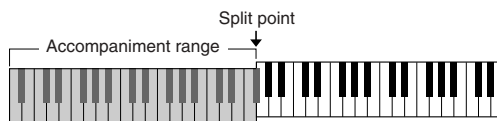

If you press the [START/STOP] button at this point rhythm-only playback will begin. Then if you play a chord in the accompaniment range bass and chord accompaniment will also begin.

You can start style playback in a number of ways – see page 33.

NOTE

- The auto-accompaniment range of the keyboard can be changed as required by changing the split point (page 59).

6 Press the [INTRO/ENDING/rit.] button.

“INTRO A” or “INTRO B” will appear in the display. Style playback will then start with an introduction, which will lead to either the MAIN A or MAIN B accompaniment pattern, accordingly.

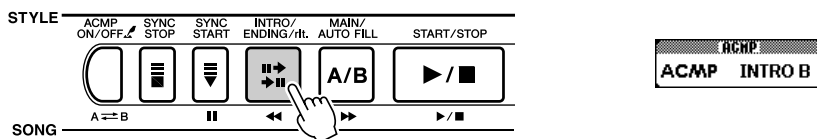

7 Press the [SYNC START] button.

The [START/STOP] button will begin flashing, indicating that the synchro-start standby mode has been engaged.

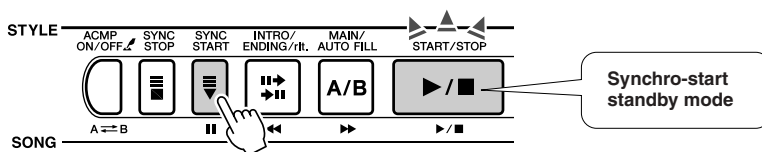

● **The Synchro-start Standby Mode Is ...**

When the synchro-start standby mode is engaged style playback will begin as soon as you play a chord in the accompaniment range of the keyboard. You can disengage the synchro-start standby mode by pressing the [SYNC START] button again.

8 Start style playback by playing a chord in the accompaniment range of the keyboard.

Not sure how to play chords? No problem! This instrument is capable of playing chords even if you only play one key – refer to page 61 for detailed instructions for playing chords.

There’s even a “Chord Dictionary” that will show you the fingerings for chords you specify by name (page 63).

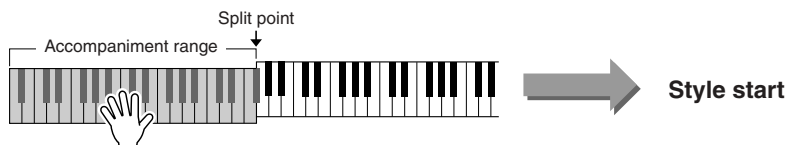

9 Play along with the style.

Play a melody with right hand while playing cords in the accompaniment range of the keyboard with your left hand. The [START/STOP] button will flash at the current playback tempo (red on the first beat of each measure, blue on the others).

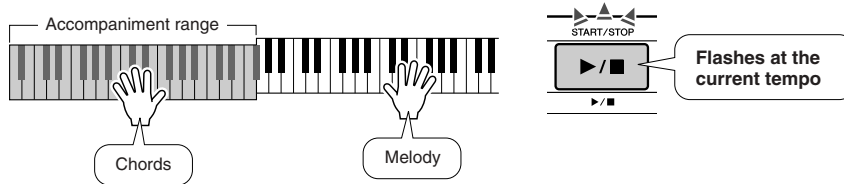

Each style has two main patterns – MAIN A and MAIN B. If you press the [MAIN/AUTO FILL] button during playback a fill-in will play and then playback will switch to the other MAIN pattern.

● An example of how you might play a pattern:

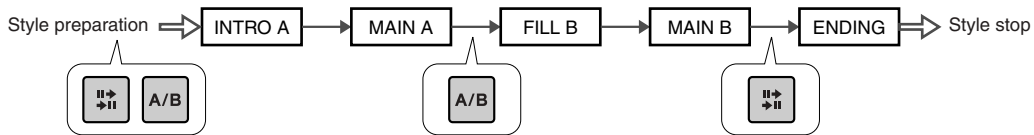

10 Press the [INTRO/ENDING/rit.] button to end.

Style playback will stop after an appropriate ending.

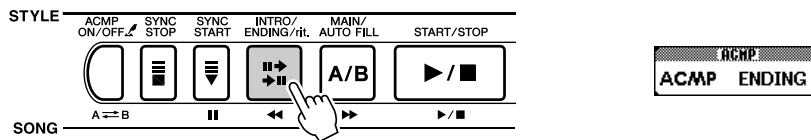

Harmony

This feature adds harmony notes to the main voice. When you press the [HARMONY] button to turn this feature on, the appropriate harmony type for the currently selected main voice is automatically selected. 26 different harmony types are provided. You can select a different harmony type by following the procedure outlined below. The effect and operation of each harmony type is different – refer to the Harmony Type List on page 104 for details.

1 Press the [HARMONY] button.

The [HARMONY] button turns the harmony feature on and off. When harmony is on the harmony icon will appear in the display.

NOTE
• Harmony cannot be turned on or off during a song lesson.

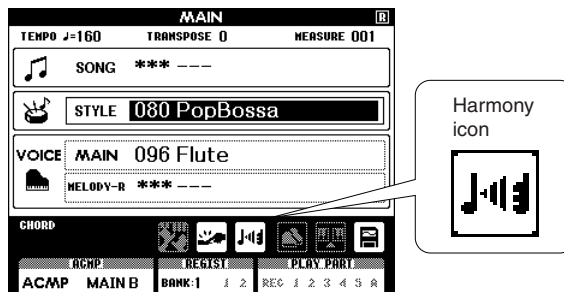

2 Press and hold the [HARMONY] button for longer than a second.

The FUNCTION display will appear.

The Harmony Type title and the currently selected harmony type will be displayed. Use the dial to select a different harmony type.

NOTE

- You can also select the Harmony Type item after pressing the [FUNCTION] button (page 70).

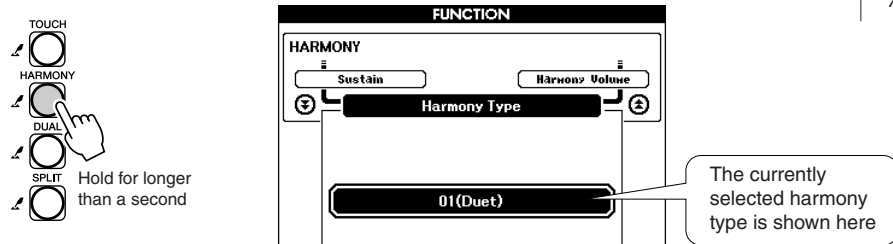

3 Select a harmony type.

Rotate the dial to select a harmony type from 01 through 26. Select “03 (Block)” for this example.

NOTE

- Harmony types 01 – 05 only function when auto-accompaniment is on and a style is being played. Harmony notes are added to the right-hand melody based on the chords played in the accompaniment range of the keyboard.
- Harmony types 06 – 26 can be used when auto-accompaniment is off. After step 4, try playing these harmony types after checking the operating conditions listed in the Harmony type list on page 104.

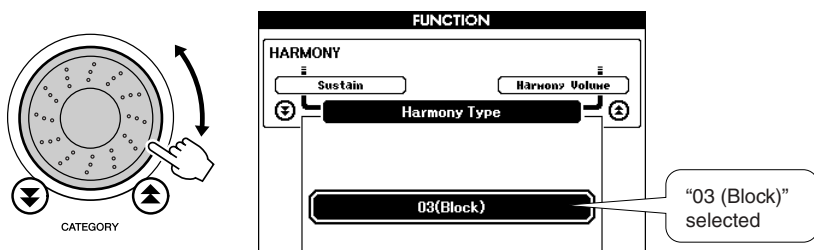

4 Press the [EXIT] button.

This will take you back to the MAIN display.

5 Perform steps 1, 2, 3, and 5 on page 29.

Check that “ACMP” appears in the display. If “ACMP” is not showing in the display press the [ACMP ON/OFF].



6 Play a chord in the accompaniment range of the keyboard.

Style playback will begin.

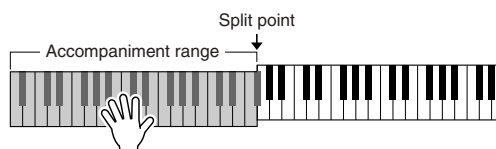

7 Play the keyboard.

Harmony notes will be added to a melody you play in the right-hand section of the keyboard.

NOTE

- The Harmony feature produces little or no effect with drum kit or sound effect voices. Use the Harmony feature with pitched instrument voices.

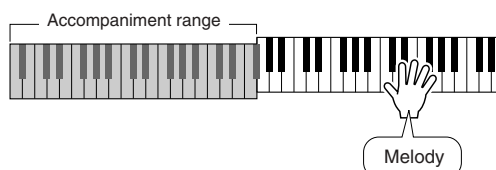

A Variety Of Ways To Start and Stop Style Playback

■ Ways To Start Style Playback.....

There are four different ways to start style playback, listed below. In all cases you will need to press the [ACMP ON/OFF] button to turn auto-accompaniment on before actually starting style playback.

Whichever method you choose you can press the [INTRO/ENDING/rit.] before starting playback to begin your performance an introduction which will automatically switch to the MAIN section when finished.

● Immediate Start

Press the [START/STOP] button to begin rhythm-only playback of the selected style. The bass and chords will begin playing as soon as you play a chord in the accompaniment range of the keyboard.

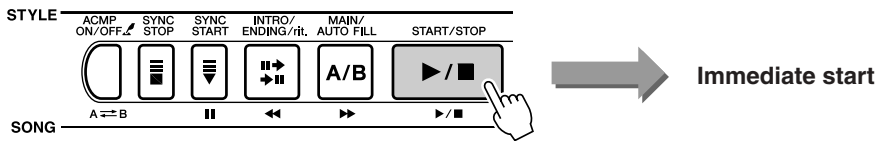

● Chord Start

Press the [SYNC START] button and the [START/STOP] button will begin flashing, indicating that the synchro start “standby” mode has been engaged. The style will begin playing as soon as you play a chord in the accompaniment range of the keyboard.

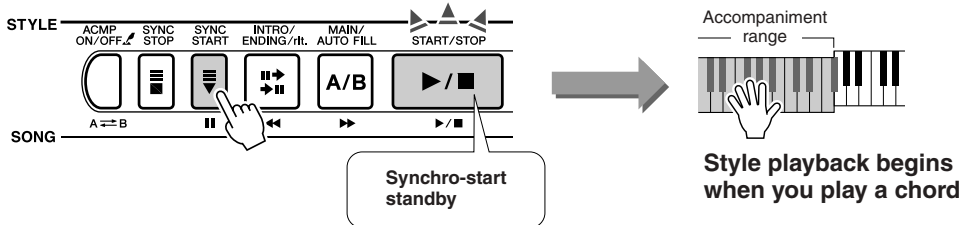

● Synchro Stop

When this function is selected the accompaniment style will only play while you are playing chords in the accompaniment range of the keyboard. Style playback will stop when you release the keys.

Press the [SYNC STOP] button. The synchro-start standby mode will be engaged and the [START/STOP] button will begin flashing. Style playback will begin as soon as you play a chord in the accompaniment range of the keyboard, but then style playback will stop (the synchro start standby mode will be re-engaged) when you release the left-hand keys. Style playback will continue only while you are actually playing in the keyboard’s accompaniment range.

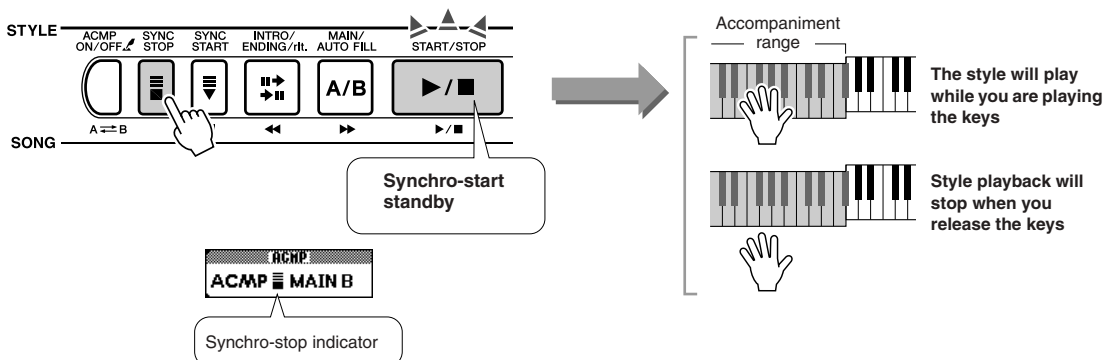

Press the [SYNC STOP] button to disengage the synchro-stop mode.

● **Tap Start**

You can supply a count-in at any tempo you like to start playback. Simply tap the [TEMPO/TAP] button at any tempo – 4 times for time signatures in 4, and 3 times for time signatures in 3 – and the selected style will begin playing at the tapped tempo.



■ **Ways To Stop Style Playback**

The following three methods can be used to stop style playback.

● **Immediate Stop**

Playback will stop as soon as you press the [START/STOP] button.

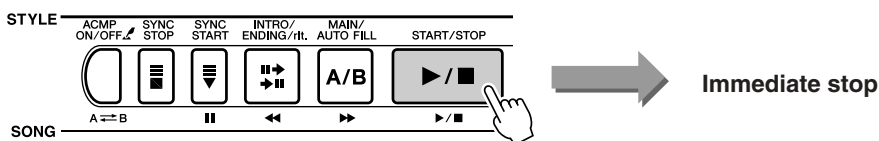

● **Stop and Enter Synchro Start Mode**

If you press the [SYNC START] button during style playback, playback will stop immediately and the synchro-start standby mode will be engaged (the [START/STOP] button will flash).

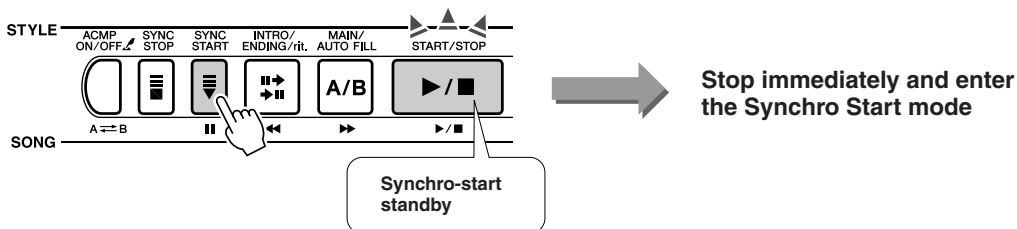

● **Play the Ending and Stop**

Press the [INTRO/ENDING/rit.] button to begin playing ending section. Playback will stop when the ending has played all the way through.



If you press the [INTRO/ENDING/rit.] button a second time (while the ending is playing) the ending will play ritardando (the tempo will gradually get slower).

■ **Changing the Voice**

During style playback the voice you play on the keyboard is the currently selected main/dual/split voices. Select an appropriate voice for the style you are using in the normal way (page 23).



Using Songs

This instrument has 30 built in songs that you can simply listen to and enjoy, or use with a range of other features. Use the songs with the lesson features described on page 39 and you have an advanced learning tool that will let you learn playing techniques as well as score reading. The internal songs aren't the only ones you can use, however. Songs you have created yourself or those you have downloaded from the Internet can also be used with many of the instrument's features.

The term "SONG" refers to a data file including both melody and auto-accompaniment data.

Select and Listen To a Song

Select a song after referring to the preset song category list on page 36.

If you want to listen to an external song file which has been transferred from a computer (036 -), use the "Media Select" function (page 67) to select the media containing the song you want to listen to (flash memory/SmartMedia) before performing the following steps.

1 Press the [SONG] button.

The song is highlighted. The song number and name will be highlighted. You can now use the dial to select a different song.

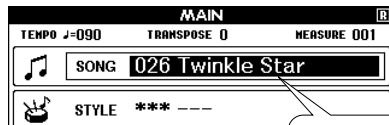

The song is highlighted. The song number and name of the currently selected song are highlighted

NOTE

- You can also press and hold the [SONG] button for longer than a second, and then select a song from the song list which appears.

2 Select a song.

Rotate the dial to select the song you want to listen to.

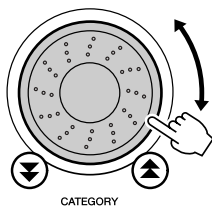

The song displayed here can be played

NOTE

- In addition to the dial you can also use the [+] and [-] buttons or the number buttons [0] - [9] to directly select songs.

3 Listen to the song.

Press the [START/STOP] button to begin playback of the selected song.

You can stop playback at any time by pressing the [START/STOP] button again.

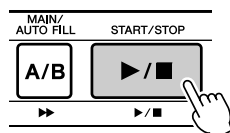

Song start!

Types Of Songs

The following three types of songs can be used by the DGX-505/305.

- **Preset Songs (the 30 songs built into the instrument).....Song numbers 001 – 030.**
- **User Songs (recordings of your own performances)Song numbers 031 – 035.**
- **External song files (song data transferred from a computer*)Song numbers 036 –.**

* The Accessory CD-ROM includes a selection of 70 MIDI songs. See page 82 for instructions on how to transfer the songs to the instrument.

The different types of songs can be saved to different song numbers. The chart below shows the basic DGX-505/305 processes flow for using the preset songs, user songs, and external song files – from storage to playback.

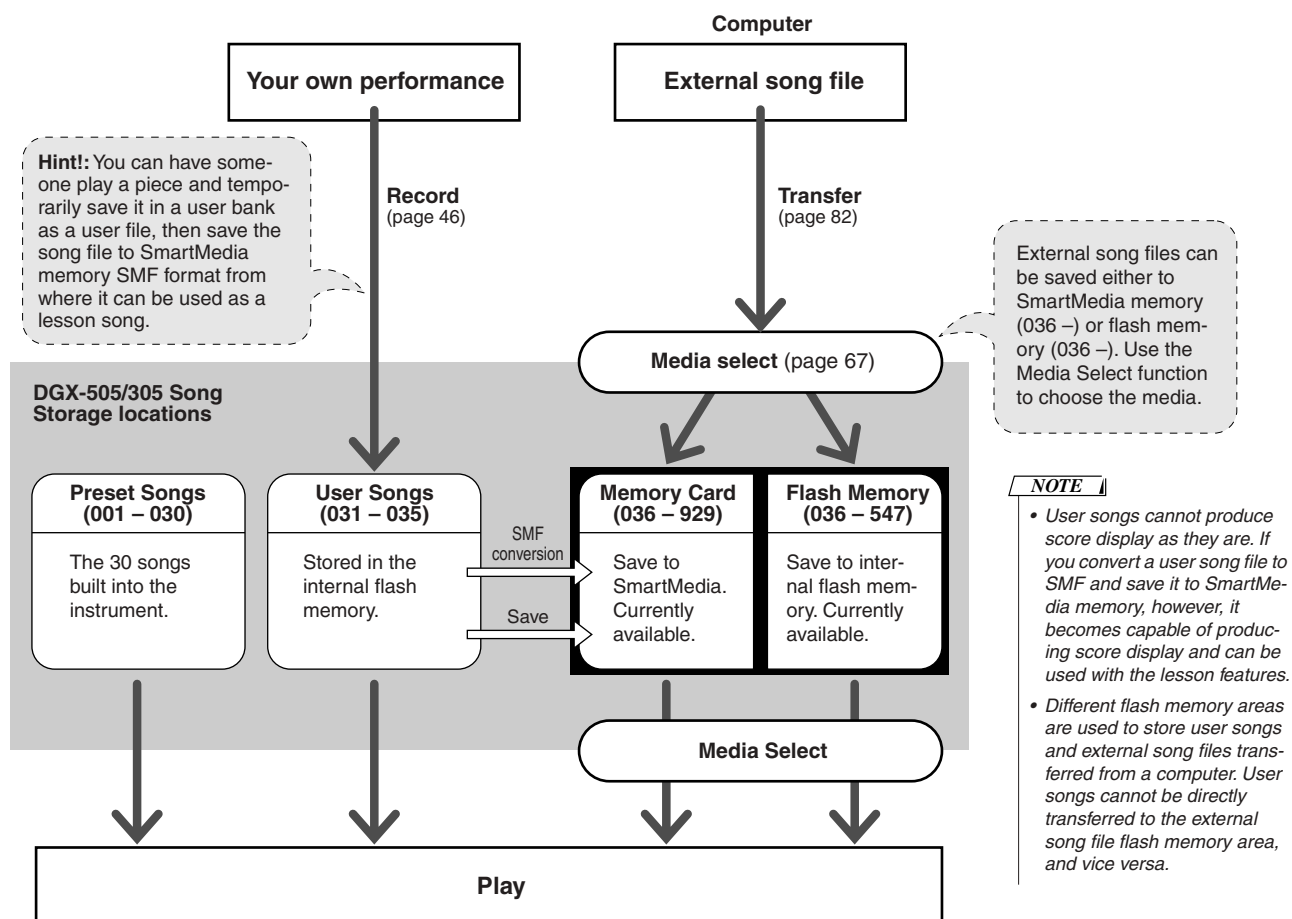

● Preset Song Categories

The 30 preset songs have been organized into 8 categories that make it easier to select appropriate songs for lessons. Refer to this chart when selecting songs.

Category	Number	Ideal for ...
Favorites	001 – 003	Popular songs, for people who want to play pops.
Easy Play	004 – 008	Right-hand melody songs. Ideal for beginner lessons.
Pianist	009 – 013	Folk songs arranged for piano. For people who want to play in a classic style.
Organist	014 – 016	Players who enjoy the rich resonance of organ pieces.
Advanced	017 – 021	Lively tunes ... when it's time to move up from one-hand lessons.
Band Play	022 – 024	Slow ballade. Experience the role of the pianist in an ensemble.
Duet	025 – 027	Songs made up of two right-hand melodies.
Holidays	028 – 030	Songs for anyone who wants to expand their repertoire.

Displaying the Song Score

This instrument is capable of displaying the scores of songs.

Scores are displayed for the 30 internal preset songs as well as songs stored in SmartMedia or flash memory.

And although user songs you record yourself cannot display a score as is, they can be converted to SMF (Standard MIDI File) format and stored to SmartMedia memory, from where they can be played with score display.

1 Select a song.

Follow steps 1 and 2 of the procedure described on page 35.

2 Press the [SCORE] button and a single-staff score will appear.

There are two types of score display: single-staff and double-staff. These are alternately selected each time the [SCORE] button is pressed.

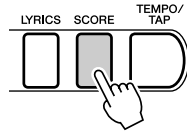

Single-staff

Double-staff

NOTE

- Both chords and lyrics will be shown in single-staff score display of a song that includes chord and lyric data.
- When there are many lyrics they may be displayed in two rows a measure.
- Some lyrics may be abbreviated if the selected song has a lot of lyrics.
- Small notes that are hard to read may be easier to read after you use the quantize function (page 72).

NOTE

- No lyrics are shown in double-staff.

3 Press the [START/STOP] button.

The song will begin playing. The triangular will move across the top of the score to indicate the current location.

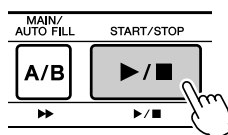

Display the Lyrics

If a song contains lyric data, the lyrics can be made to appear on the display. No lyrics will be displayed for a song that contains no lyric data even if the [LYRICS] button is pressed.

1 Select a song.

Select a song between 001 – 003 by performing steps 1 and 2 described on page 35.

2 Press the [LYRICS] button.

The title, lyricist, and composer of the song will appear on the display.

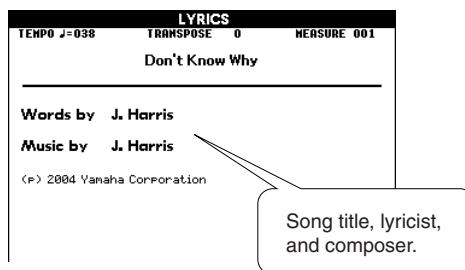
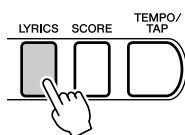

NOTE

• Songs downloaded from the Internet or commercially available song files, including XF format files (page 6), are compatible with the lyrics display features as long as they are standard MIDI file format files containing lyric data. Lyrics display may not be possible with some files.

NOTE

• If the lyrics display shows garbled characters, try changing the display language (page 22).

3 Press the [START/STOP] button.

The song will play back while the lyrics and chords are shown on the display. The lyrics will be highlighted to show the current location in the song.

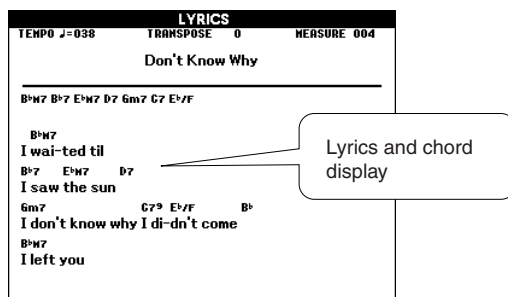
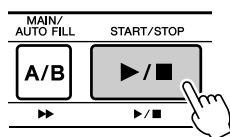

■ Preset Songs That Can be Used For Lyrics Display

Number	Name
001	Don't Know Why (Jesse Harris)
002	My Favorite Things (From The Sound Of Music) (Oscar Hammerstein II/Richard Rogers)
003	Fly Me To the Moon (In Other Words) (Bart Howard)



Select a Song For a Lesson

Yamaha Education Suite 4

You can select any song you like and use it for a left-hand, right-hand, or both-hands lesson. You can also use songs (only SMF Format 0) downloaded from the Internet and saved to flash memory/SmartMedia. During the lesson you can play as slowly as you like, and you can even play wrong notes. Song playback will slow down to a speed you can handle. It's never too late to start learning!

The lesson procedure is as follows:

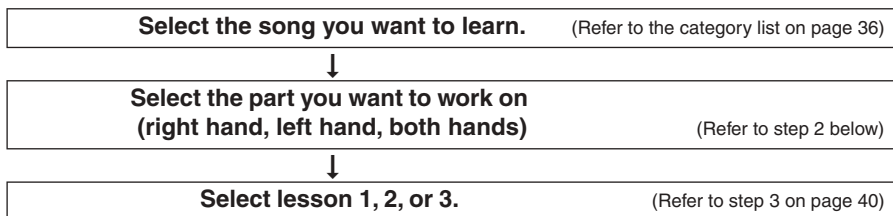

NOTE

• The [SCORE] button and the [LYRICS] button will not function during a lesson.

- Lesson 1(Learn to play the correct notes): The song will wait until you play the right note.
- Lesson 2(Learn to play the correct notes with the correct timing): Song playback tempo will vary to match the speed you are playing at. The song will slow down when you play wrong notes, so you can learn at your own pace.
- Lesson 3(Learn to play the correct notes at the correct timing along with the song): here's where you can perfect your technique.

The songs available for your practices are the ones in SMF Format 0 (page 76). You need to specify which channels are to be played back as the right/left-hand parts when you practice the songs downloaded from the Internet (page 83).

Lesson 1: Waiting

1 Select a song for your lesson.

Press the [SONG] button from the MAIN display so that the song number and name are highlighted. Use the dial to select the song you want to use for your lesson. As listed on page 36 there are a variety of song types. For this example select "011 Londonderr Air" from the "PIANIST" category (009 – 013).

NOTE

• Song numbers 004 – 008 (Simple melodies) are intended for use as right-hand lessons, and cannot be used for left-hand or both-hands lessons.

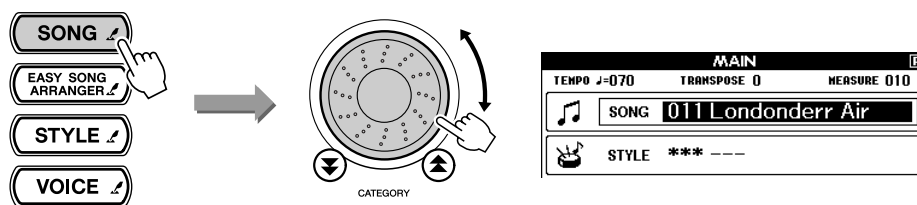

Normally "R" (Right hand) will appear in the upper right corner of the MAIN display. You can start a right-hand lesson simply by pressing the [LESSON MODE] button.

2 Select the part you want to practice.

Press the [LESSON L/R] button to select the part you want to practice. Each time you press the [LESSON L/R] button the parts are selected in sequence: right hand → left hand → both hands → right hand The currently selected part is shown in the upper right corner of the display.

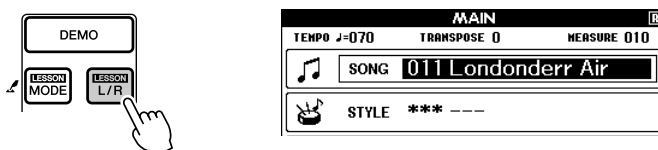

Select "R" for a right-hand lesson, "L" for a left-hand lesson, or "LR" for a both-hands lesson.

3 Use the [LESSON MODE] button to select Lesson 1.

Press the [LESSON MODE] button to select Lesson 1.

Each time the [LESSON MODE] button is pressed the lesson modes are selected in sequence: Lesson 1 → Lesson 2 → Lesson 3 → Off → Lesson 1 The currently selected mode is shown in the upper right corner of the display.

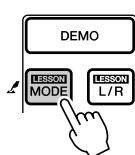

What the upper-right-corner displays mean:

	Right Hand	Left Hand	Both hands
Lesson 1	R1	L1	LR1
Lesson 2	R2	L2	LR2
Lesson 3	R3	L3	LR3

NOTE

- When you switch lesson modes an explanation of the selected lesson will appear on the display for a few seconds before the lesson begins.
- If the score display is not ready by the time the explanation display disappears, prepare-in-progress message will appear on the display until the score is ready.

Song playback will begin automatically when you select Lesson 1.

Play the note shown immediately below the triangular score marker (▼). The dot on the graphic keyboard indicates the key you need to press to play that note. When you play the correct note the marker will move to the next note you need to play. The song will wait until you play the correct note.

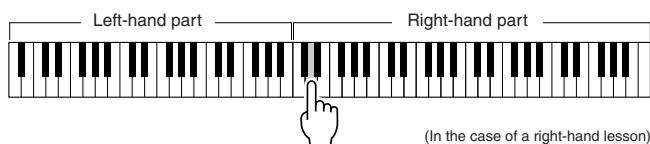
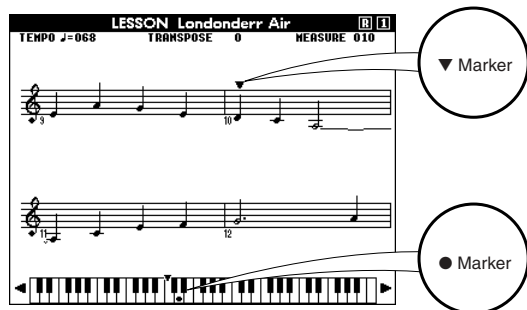

● Shifting the keyboard left or right.

The hidden () areas of the keyboard can be brought into view by pressing the [+] or [-] button.

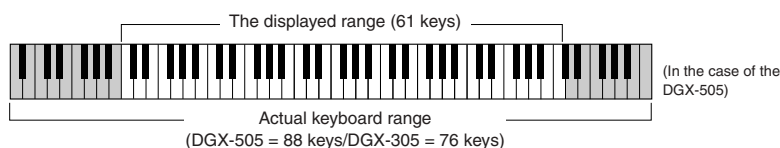

61 keys of the keyboard's range are shown on the display. The DGX-505 actually has 88 keys, while the DGX-305 has 76 keys. In some songs that include very high or low notes, those notes may fall outside the displayed range and may not be shown on the display. In such cases an "over" indicator appear to the left or right of the graphic keyboard. Use the [+] or [-] button to shift the keyboard left or right so you can see the notes (the ● marker will appear on the appropriate key in the display). Notes that actually fall outside the keyboard's range cannot be used in the lesson.

■ See How You've Done.....



When the lesson song has played all the way through your performance will be evaluated in 4 levels: OK, Good, Very Good, or Excellent. "Excellent!" is the highest evaluation.

The evaluation will appear after you have played all the way through the song. After the evaluation display has appeared, the lesson will start again from the beginning. Press the [START/STOP] button to exit from the lesson mode and return to the MAIN display.

NOTE

- The evaluation feature can be turned off via the FUNCTION display Grade item (page 72).

Once you've mastered Lesson 1, move on to Lesson 2.

Lesson 2: Your Tempo

1 Select the song and part you want to practice (steps 1 and 2 on page 39).

2 Press the [LESSON MODE] button twice to start Lesson 2.

Each time the [LESSON MODE] button is pressed the lesson modes are selected in sequence: Lesson 1 → Lesson 2 → Lesson 3 → Off → Lesson 1 ...

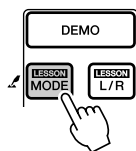

Icons representing the selected part and lesson appear in the upper right corner of the display. In this case the icons "R2" indicate that right-hand lesson 2 has been selected.

Song playback will begin automatically when Lesson 2 is selected.

The triangular marker will appear in the score display, and will move to indicate the current note in the song. Try to play the notes at the correct timing. As you learn to play the right notes at the right timing the tempo will increase until eventually you'll be playing at the song's original tempo.



Play while following the score marker

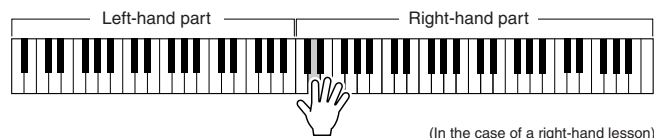

(In the case of a right-hand lesson)

The evaluation display will appear when the song has played all the way through.

Press the [START/STOP] button to exit from the lesson mode and return to the MAIN display.

Once you've mastered Lesson 2, move on to Lesson 3.

Lesson 3: Minus One

1 Select the song and part you want to practice (steps 1 and 2 on page 39).

2 Press the [LESSON MODE] button three times to start Lesson 3.

Each time the [LESSON MODE] button is pressed the lesson modes are selected in sequence: Lesson 1 → Lesson 2 → Lesson 3 → Off → Lesson 1 ...

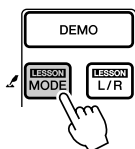

Icons representing the selected part and lesson appear in the upper right corner of the display. In this case the icons "R3" indicate that right-hand lesson 3 has been selected.

Song playback will begin automatically when Lesson 3 is selected.

The song will play at the normal tempo, minus the part you have chosen to play. Play along while listening to the song. The score marker and keyboard marker in the display will indicate the notes to play.

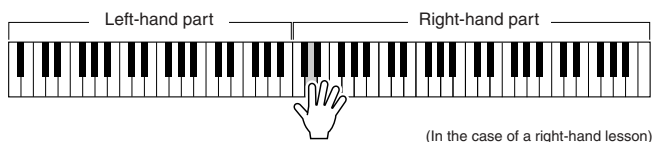
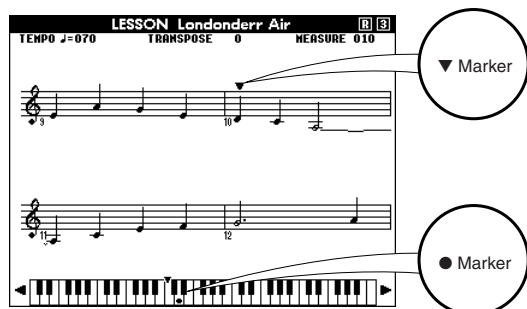

The evaluation display will appear when the song has played all the way through. Press the [START/STOP] button to exit from the lesson mode and return to the MAIN display.

Practice Makes Perfect – Repeat and Learn

Use this feature when you want to start again just ahead of a section on which you made a mistake, or to repeatedly practice a section you find difficult.

Press the [LESSON REPEAT & LEARN] button during a lesson.

The song location will move back four measures from the point at which you pressed the button, and playback will begin after a one-measure count-in. Playback will continue up to the point at which you pressed the [LESSON REPEAT & LEARN] button, and then jump back four measures and begin again after a count-in. This process will repeat, so all you have to do is press [LESSON REPEAT & LEARN] when you make a mistake in order to repeat practice of that section until you get it right.

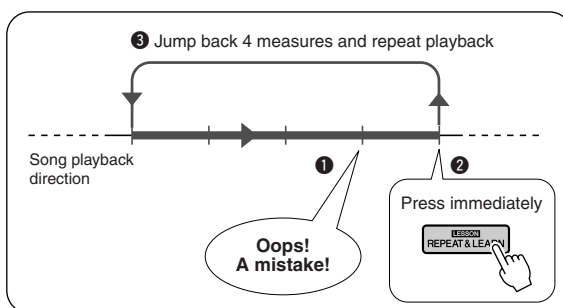
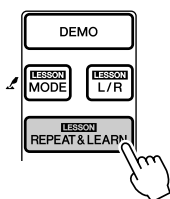

NOTE

- You can change the number of measures the Repeat and learn function jumps back by pressing a number button [0] – [9] during repeat playback.

Change a Song's Style

In addition to each song's default style, you can select any other style to play the song with the Easy Song Arranger feature. This means that you can play a song that is normally a ballad, for example, as a bossa nova, as a hip-hop tune, etc. Since songs are combinations of a melody and a style, you can create totally different arrangements by changing the style with which a song is played. You can also change the song's melody voice and the keyboard voice for a complete change of image.

Using the Easy Song Arranger

1 Press the [EASY SONG ARRANGER] button.

The song number and name in the EASY SONG ARRANGER MAIN display will be highlighted. You can now use the dial to select a different song.



The currently selected song number and name are displayed here.

2 Select a song.

Use the dial to select the song you want to arrange. For this example select "004 Down By The River."

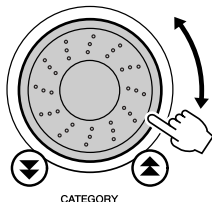

NOTE

You can't use the Easy Song Arranger directly with user songs (031 – 035), but you can convert user songs to SMF (Standard MIDI File) format and save them to SmartMedia memory (page 76), from where they can be used with the Easy Arranger feature.

3 Listen to the song.

Press the [START/STOP] button to begin playback of the song. Move on to the next step while the song is playing.

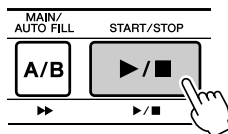

Song start!

NOTE

When playing song numbers 022 – 024 while using the Easy Song Arranger, melody tracks will be automatically muted and no melody will sound. In order to hear the melody tracks you will need to press the SONG MEMORY buttons [3] – [5].

4 Press the [EASY SONG ARRANGER] button.

The style number and name in the EASY SONG ARRANGER MAIN display will be highlighted. You can now use the dial to select a different style.

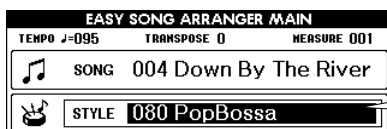

The currently selected style number and name are displayed here.

5 Select a style.

Rotate the dial and listen to how the song sounds with different styles. As you select different styles the song will remain the same while only the styles change. When you have selected a suitable style move on to the next step while the song is still playing (if you have stopped the song, start it again by pressing the [START/STOP] button).

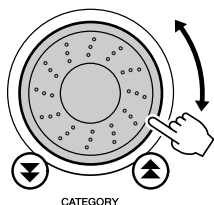

NOTE

- Because the Easy Song Arranger uses song data you can't specify chords by playing in the accompaniment range of the keyboard. The [ACMP ON/OFF] button will not function.
- If the time signature of the song and style are different, the time signature of the song will be used.

6 Press and hold the [VOICE] button for longer than a second.

Hold the [VOICE] button until the VOICE SELECT (MAIN) display appears.



Hold for longer than a second

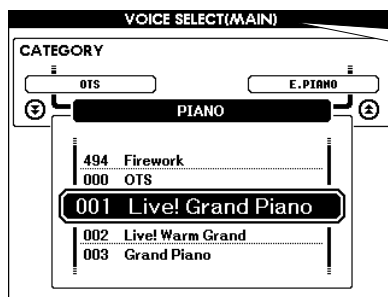

Each time you press the [VOICE] button the Dual Voice, Split Voice, Melody R, and Melody L displays will be selected in sequence.

7 Press the [VOICE] button three times.

The VOICE SELECT (MELODY R) display will appear so you can select the Melody R voice.



Press three times

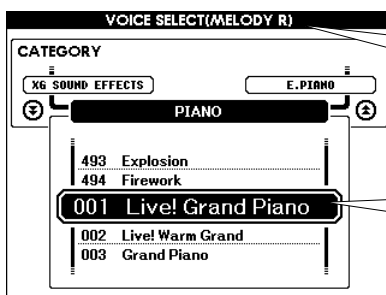

VOICE SELECT (MELODY R) display

The currently selected melody voice will be displayed.

Each time you press the [VOICE] button the section of the display title inside the parentheses will change: MAIN → DUAL → SPLIT → MELODY R → MELODY L → MAIN ... The MAIN, DUAL, and SPLIT displays allow you to change the keyboard voices, while the MELODY R and MELODY L display are used to change the song melody voice.

8 Select a voice.

Use the dial to change the melody voice. As you select different melody voices the song will remain the same while only the melody voice changes (if you have stopped the song, start it again by pressing the [START/STOP] button).

You can save the Easy Song Arranger settings to SmartMedia memory. Refer to page 78 for more information.

NOTE

- **The Difference Between MELODY R and MELODY L ...**
Songs are a combination of a melody and an auto-accompaniment style. Normally "melody" refers to the right-hand part, but in this instrument "melody" parts are provided for both the right and left hands. MELODY R is the melody part played by the right hand, and MELODY L is the melody part played by the left hand.



Record Your Own Performance

You can record up to 5 of your own performances and save them as user songs 031 through 035. Once your performances have been saved as user songs, they can be converted to SMF (Standard MID File) format files and saved to SmartMedia memory (page 76) and used with score display. So when inspiration strikes and you create a great melody, you can save it in both listenable and written score form. You can also record performances using the performance assistant technology.

Recordable Data

You can record to a total of 6 tracks: 5 melody tracks and 1 style (chord) track. Each track can be recorded individually.

- **Melody Track [1] – [5]** Record the melody parts.
- **Style Track [A]**..... Records the chord part.

● Data Recorded On the Melody Tracks [1] – [5]	● Data Recorded On the Style Track [A]
<ul style="list-style-type: none"> • Note on/off (keys pressed and released) • Velocity (keyboard dynamics) • Voice number • Reverb type* • Chorus type* • Harmony note • Sustain on/off • Tempo*/time signature* (only when the style track is not recorded) • Pitch bend • Pitch bend range • Dual voice on/off • Function sustain on/off • Main/Dual voice – Voice volume, Octave, Pan, Reverb send level, Chorus send level 	<ul style="list-style-type: none"> • Chord changes and chord timing • Style pattern changes • Style number* • Reverb type* • Chorus type* • Tempo • Time signature* • Style volume*

* These data items are recorded at the beginning of the track. Changes made during the song will not be recorded.

NOTE

- A maximum of 5 user songs can be recorded. If you record a 6th song after recording to the 5 available user song locations, choose a song number (031 – 035) containing a song that you don't mind erasing, or save the user song data to SmartMedia memory so that you can overwrite the internal user song memory without permanently losing your song data.
- Up to approximately 10,000 notes can be recorded if you record only to the melody tracks. Up to approximately 5,500 chord changes can be recorded if you record only to the style track.
- User songs cannot display a score as is, but they can be converted to SMF (Standard MIDI File) format and stored to SmartMedia memory (page 76), from which they can be played with score display.

Track Configuration

To record your own performance, first use the SONG MEMORY [1] – [5] and [A] buttons to specify the track(s) you want to record on. The track you record on determines the part that plays back later.

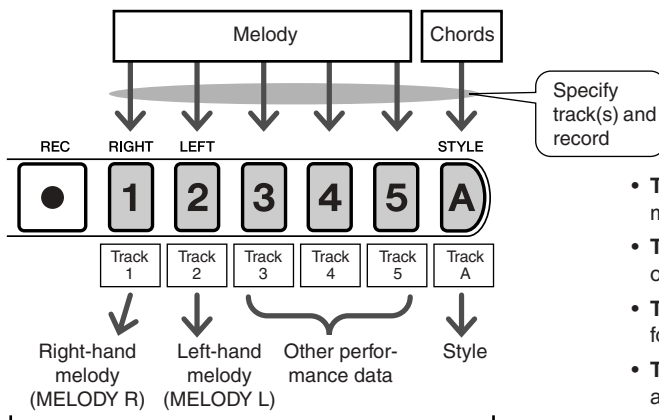

The parts played by each track when a user song is played back.

- **Track [1]** – Will play back as the right-hand melody part (MELODY R)
- **Track [2]** – Will play back as the left-hand melody part (MELODY L)
- **Tracks [3] – [5]** – Will play back as “other” performance data.
- **Track [A]** – Will play back as the Style (auto-accompaniment) part.

Recording Procedure

- From the MAIN display press the [SONG] button, then use the dial to select the user song number (031 – 035) you want to record to.

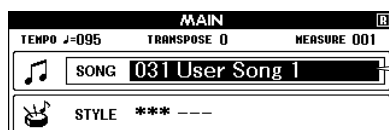

Rotate the dial to select a song number between 031 and 035.

- Select the track(s) you want to record to and confirm your selection on the display.

◆ Record a Melody Track and the Accompaniment Track Together

Press the melody track button [1] – [5] you want to record to while holding the [REC] button.

Next, press the [A] button while holding the [REC] button.

The selected tracks will be highlighted in the display.

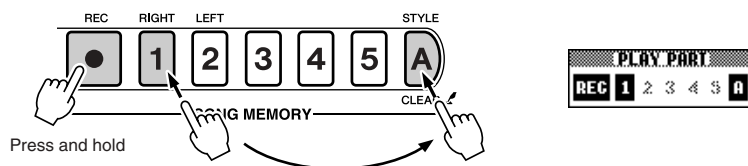

⚠ CAUTION

- If you record to track that contains previously-recorded data the previous data will be overwritten and lost.

NOTE

- Style accompaniment is automatically turned on when you select the style track [A] for recording.
- Style accompaniment cannot be turned on or off while recording is in progress.
- If you use a split voice for recording, notes played to the left of the split point will not be recorded.

● Track Selection Precautions

Keep the following points in mind when selecting tracks for recording.

- If you want to use the recorded melody for a right-hand lesson.**
Select track [1] for recording. If you select track [2] the part will be displayed as a left-hand part (MELODY L) and will not be available for use as a right-hand lesson.
- If you want to display the user song as a single-staff score.**
Record the melody part on track [1]. Only the right-hand melody part (MELODY R) can be displayed as a single-staff score. Parts recorded on track [2] can not be displayed on a single-staff score.

*User songs cannot be used for score display or lessons as is, but they can be converted to SMF (Standard MIDI File) format and stored to SmartMedia memory, from which they can be played with score display or used for lessons.

◆ Record a Melody track

Press the melody track button [1] – [5] you want to record to while holding the [REC] button.

The selected track will be highlighted in the display.

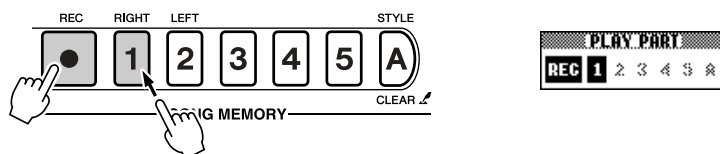

NOTE

- If style accompaniment is on and track [A] has not yet been recorded, the style track [A] will automatically be selected for recording when a melody track is selected. If you only want to record a melody track, be sure to turn the style track [A] off.
- To cancel recording to a selected track, press that track button a second time. Style accompaniment cannot be turned on or off while recording is in progress.

3 Recording will start when you play on the keyboard.

You can also start recording by pressing the [START/STOP] button.
The current measure will be shown on the display during recording.

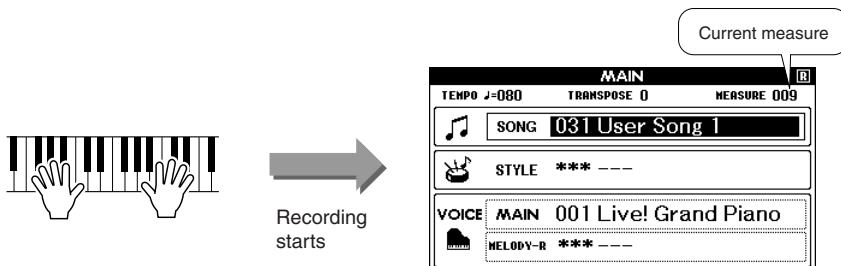

NOTE

- If the memory becomes full during recording a warning message will appear and recording will stop automatically. Use the song clear or track clear (page 48) function to delete unwanted data and make more room available for recording, then do the recording again.

4 Stop recording by pressing the [START/STOP] or [REC] button.

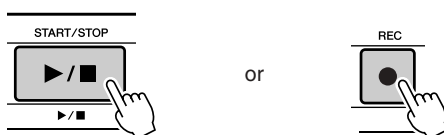

If you press the [INTRO/ENDING/rit.] button while recording the style track an appropriate ending pattern will play and then recording will stop. When recording stops the current measure number will return to 001 and the recorded track numbers in the display will be shown in a box border.

● To Record Other Tracks

Repeat steps 2 through 4 to record any of the remaining tracks.

By selecting an unrecorded track – SONG MEMORY buttons [1] – [5], [A] – you can record the new track while listening to previously recorded tracks (the playback tracks will appear in the display). You can also mute previously recorded tracks (the muted tracks will not appear in the display) while recording new tracks.

● To Re-record a Track

Simple select the track you want to re-record for recording in the normal way. The new material will overwrite the previous data.

5 When the recording is done ...

◆ To Play Back a User Song

User songs are played back in the same way as regular songs (page 35).

- 1 Press the [SONG] button from the MAIN display.
- 2 The current song number/name will be highlighted – use the dial to select the user song (031 – 035) you want to play.
- 3 Press the [START/STOP] button to start playback.

◆ To Save a User Song to SmartMedia Memory → page 75.

◆ To save a User Song to SmartMedia Memory in SMF format → page 76.

Song Clear – Deleting User Songs

This function clears an entire user song (all tracks).

1 From the MAIN display select the user song (031 – 035) you want to clear.

2 Press and hold the SONG MEMORY [1] button for longer than a second while holding the SONG MEMORY [A] button.

A confirmation message will appear on the display.

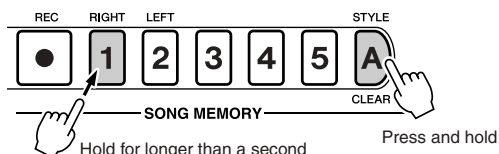

3 Press the [+] button.

A confirmation message will appear on the display.

You can cancel the clear operation by pressing the [-] button.

4 Press the [+] button to clear the song.

The clear-in-progress message will appear briefly on the display while the song is being cleared.

NOTE

- If you only want to clear a specific track from a user song use the Track Clear function.

NOTE

- To execute the Song Clear function press the [+] button. Press [-] to cancel the Song Clear operation.

Track Clear – Deleting a Specified Track From a User Song

This function lets you delete a specified track from a user song.

1 From the MAIN display select the user song (031 – 035) you want to clear.

2 Press and hold the SONG MEMORY track button ([1] – [5], [A]) corresponding to the track you want to clear for longer than a second.

A confirmation message will appear on the display.

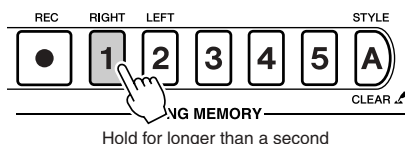

3 Press the [+] button.

A confirmation message will appear on the display.

You can cancel the clear operation by pressing the [-] button.

4 Press the [+] button to clear the track.

The clear-in-progress message will appear briefly on the display while the track is being cleared.

NOTE

- To execute the Track Clear function press the [+] button. Press [-] to cancel the Track Clear operation.



Backup and Initialization

Backup

Some internal DGX-505/305 parameters will revert to their default values if not saved before the power is turned off. In order to backup these parameters press and hold the [FUNCTION] button for longer than a second.



● The Backup Parameters

- User songs.
- Style files.
- Touch response on/off.
- Registration memory.
- The following FUNCTION display settings:
Tuning, Split Point, Touch Sensitivity, Style Volume, Song Volume, Metronome Volume, Grade, Demo Cancel, Language Selection, Media Select, Panel Sustain.

Initialization

This function erases all backup data in the instrument’s flash memory and restores the initial default settings. The following initialization procedures are provided.

■ Backup Clear

To clear data backed up to the internal flash memory – panel user setting, registration memory (page 68), user songs (page 46), style files (page 60) – turn the power on by pressing the [STANDBY/ON] switch while holding the highest white key on the keyboard. The backed up data will be erased and the default values restored.

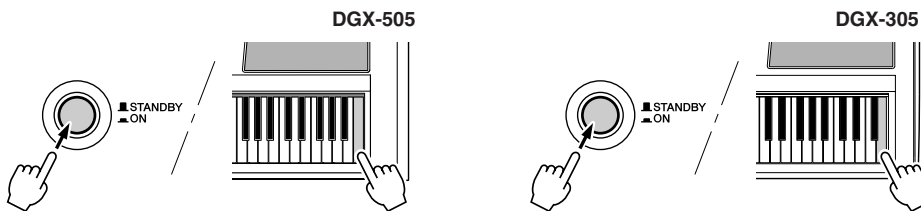

■ Flash Clear

To clear song data that has been transferred to the internal flash memory from a computer, turn the power on by pressing the [STANDBY/ON] switch while simultaneously holding the highest white key on the keyboard and the three highest black keys.

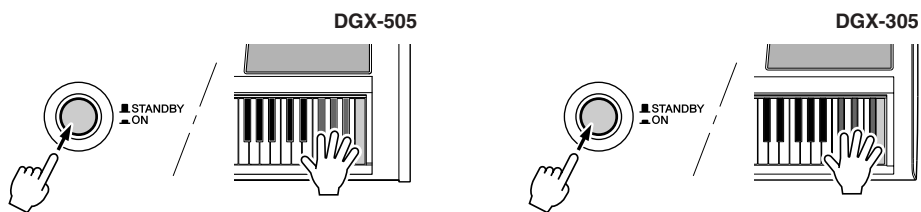

⚠ CAUTION

- When you execute the Flash Clear operation, song data you have purchased will also be cleared. Be sure to save data you want to keep to a computer.



Basic Operation and Displays

Basic Operation

Overall DGX-505/305 control is based on the following simple operations.

1 Press a button to select a basic function.

2 Use the dial to select an item or value.

3 Start a function.

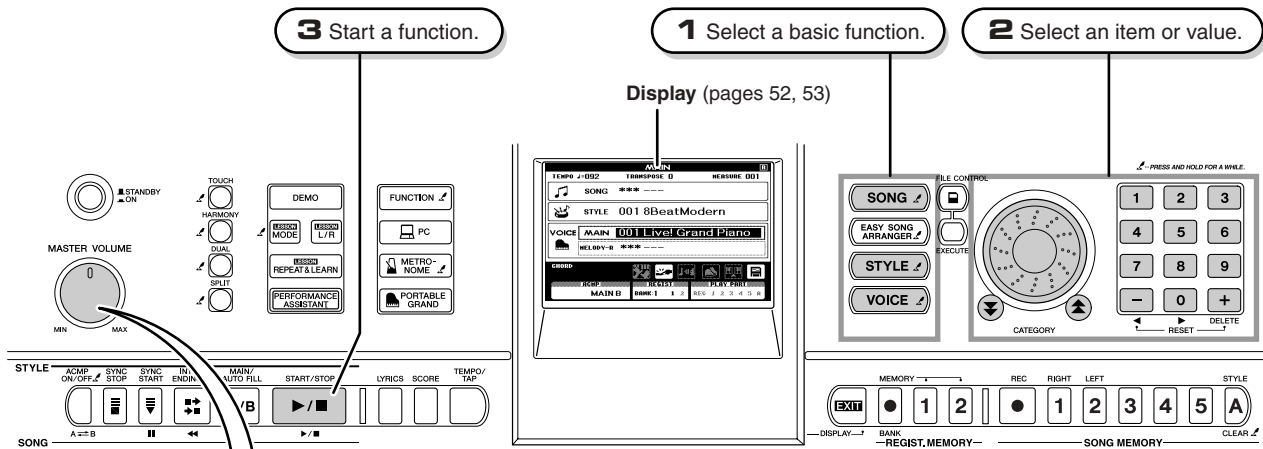

● Volume Adjustment

Adjusts the volume of the sound heard via the instrument's speakers or a pair of headphones plugged into the PHONES jack.

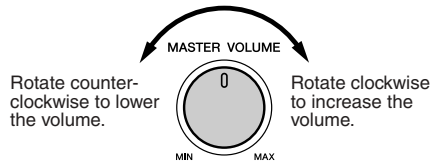

1 Press a button to select a basic function.

- SONG** — Select a song you want to listen to or a song you want to use for a lesson.
- EASY SONG ARRANGER**
- STYLE** — Select an auto-accompaniment style.
- VOICE** — Select a voice you want to play on the keyboard.

2 Use the dial to select an item or value.

When you select a basic function, the item corresponding to that function will be highlighted in the display. You can then use the dial or the number buttons [0] – [9] to select the desired item.



The selectable item is highlighted in the display. In this example the [SONG] button has been pressed.

■ Changing Values.....

● Dial

Rotate the dial clockwise to increase the value of the selected item, or counterclockwise to decrease its value. Rotate the dial continuously to continuously increase or decrease the value.

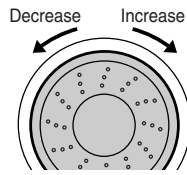

● [+] and [-] Buttons

Press the [+] button briefly to increment the value by 1, or press the [-] button briefly to decrement the value by 1. Press and hold either button to continuously increment or decrement the value in the corresponding direction.

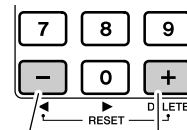

Press briefly to decrement. Press briefly to increment.

● Number Buttons [0] – [9]

The number buttons can be used to directly enter a song number or parameter value. Hundreds or tens digits that are "0" can be omitted (see below).

Example: Song number "003" can be entered in three ways.

- [0] → [0] → [3]
- [0] → [3]
("003" will appear on the display after a brief delay)
- [3]
("003" will appear on the display after a brief delay)

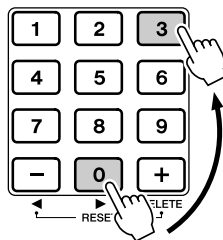

Press number buttons [0], [0], [3].

● CATEGORY Buttons [▲], [▼]

When selecting a song, style, or voice, you can use these buttons to jump to the first item in the next or previous category.



Jump to the first item in the next or previous category.

The CATEGORY buttons are useful for selecting categorized items, as in the example below.

Example: VOICE SELECT Display

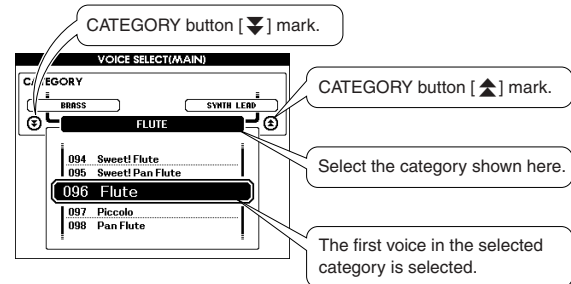

In a display in which a category appears, selection is easy if you first use the CATEGORY [▲] and [▼] buttons to select the category containing the desired item, then use the dial or [+] and [-] buttons to select the item. This can be particularly handy when you have to select from a large number of voices.

In most procedures described throughout this owner's manual the dial is recommended for selection simply because it is the easiest and most intuitive selection method. Please note however, that most items or values that can be selected using the dial can also be selected using the [+] and [-] buttons.

3 Start a function.

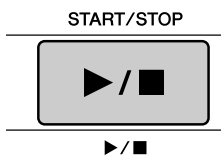

This is the [START/STOP] button.

Press the [START/STOP] button after pressing the [SONG] or [STYLE] button to start playback of the selected song or style (rhythm).

The Displays

● Display Names

All operations are carried out while watching the display. A number of display types are provided for different modes and functions. The name of the current display appears at the top of the display.

● MAIN Display



To Return To the MAIN Display

Most basic operations are carried out from the instrument's MAIN display. You can return to the MAIN display from any other display by pressing the [EXIT] button near the lower right corner of the display panel.

● FUNCTION Display (page 70)

The FUNCTION display provides access to 44 utility functions.

The FUNCTION display appears when the [FUNCTION] button is pressed. In the FUNCTION display you can use the CATEGORY [▲] and [▼] buttons (page 51) to select 44 different groups of functions. Press the CATEGORY button(s) as many times as necessary until the required function appears. You can then use the dial, the [+] and [-] buttons, or the number [0] – [9] buttons to adjust the value of the function as required.

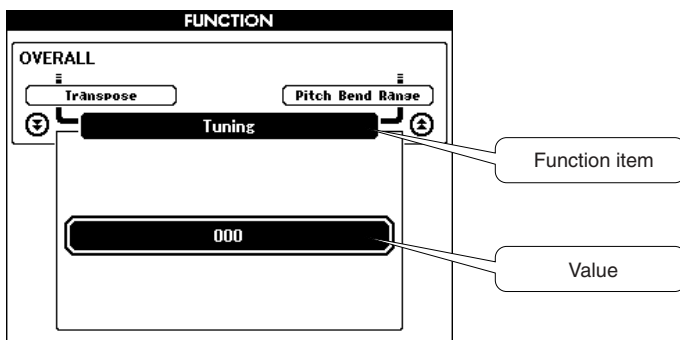

The “Press & Hold” Symbol

The “” symbol that appears next to some buttons indicates that the button can be pressed and held for longer than a second to call up a related function. This provides convenient direct access to a range of functions.

TOUCH

MAIN Display Items

The MAIN display shows all of the current basic settings: song, style, voice. It also includes a range of indicators that show the on/off status of a range of functions.

* Adjust the LCD CONTRAST control on the rear panel of the instrument for optimum display legibility.

LCD CONTRAST

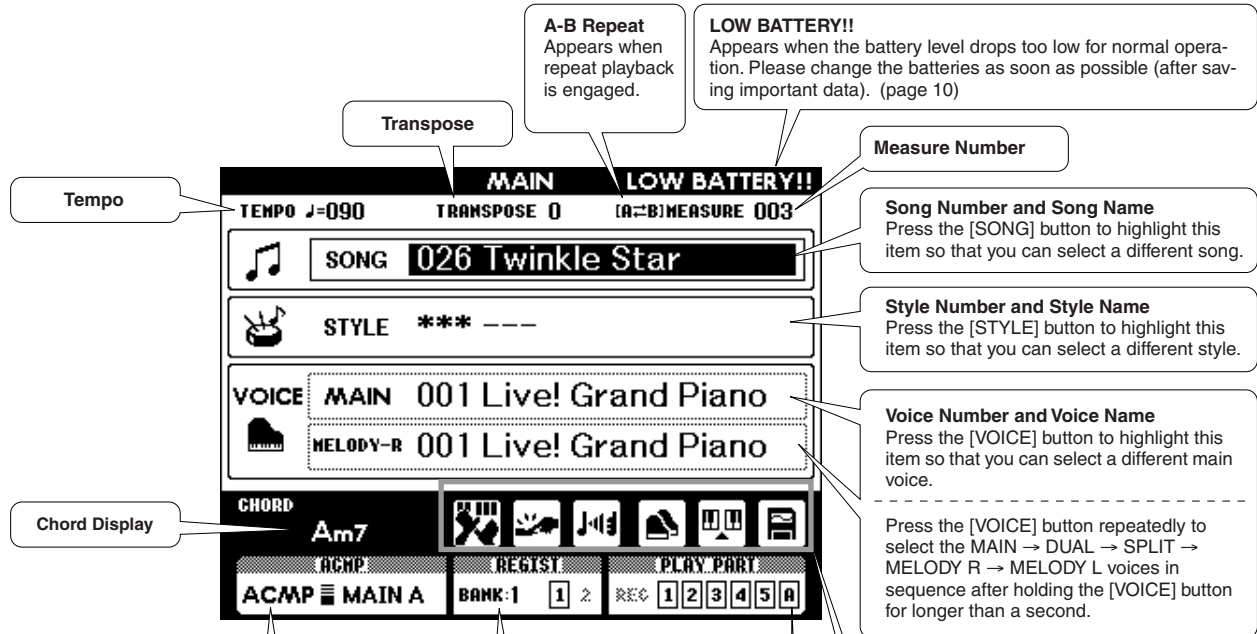

Style (Auto-accompaniment) Status (page 29)

ACMP Appears when the [ACMP ON/OFF] button is pressed to turn accompaniment on after selecting a style. When showing the keyboard range to the left of the split point is used for accompaniment chord recognition. Style playback can be started in a number of ways (page 33).

≡ Appears when the synchro-stop function is engaged.

MAIN A The style pattern name.

Registration Memory Status (page 68)

BANK:1 Shows the selected bank number.

1 2 Shows the memory numbers that contain data. A border appears around the selected number.

Song Track Status (page 45)

Highlighted during user song recording.

1 2 3 4 5 6 The track(s) selected for recording are highlighted during user-song recording. Only tracks that contain data are displayed. A border appears around a selected track that contains data. No border appears around a Muted track.

Function ON/Off Icons

- Performance assistant technology** Appears when the performance assistant technology is on.
- Touch Response** Appears when Touch Response is on. When this icon is showing you can control the dynamics of the sound by how hard you play the keys.
- Harmony** Appears when Harmony is on. When this icon is showing harmony notes will be added to the main voice.
- Dual** Appears when the Dual Voice is on. When this icon is showing a second voice is "layered" on and played with the main voice.
- Split** Appears when the Split Voice is on. When this icon is showing different voices can be played to the left and right of the keyboard split point.
- File Control** Appears when it is possible to access a SmartMedia memory card.

Handy Performance Features

Adding Reverb

Reverb lets you play with a rich concert hall type ambience.

When you select a style or song the optimum reverb type for the voice used is automatically selected. If you want to select a different reverb type, use the procedure described below. Refer to the Effect Type List on page 104 for information about the available reverb types.

- 1 Press the [FUNCTION] button to call up the FUNCTION display.

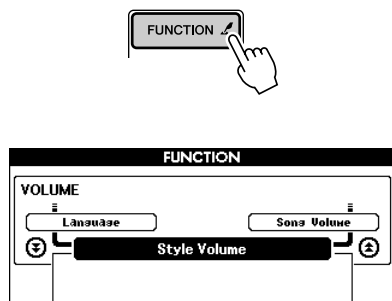

- 2 Use the CATEGORY [▲] and [▼] buttons to select the Reverb Type item.

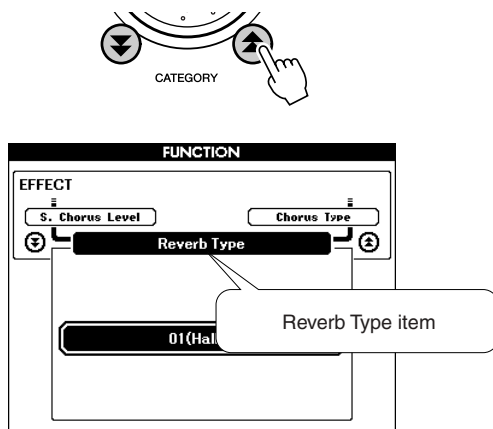

- 3 Use the dial to select a reverb type.

You can check how the selected reverb type sounds by playing on the keyboard.

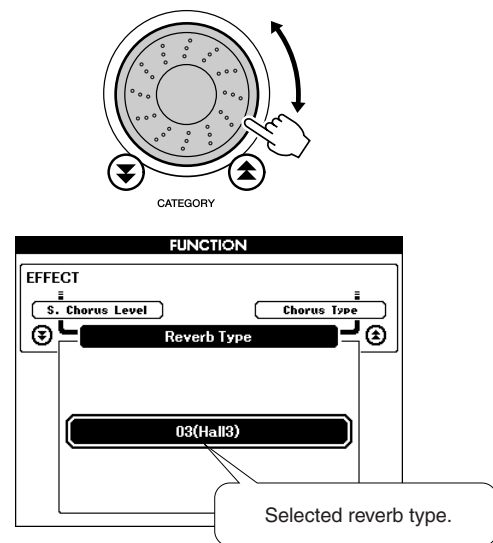

● Adjusting the Reverb Send Level

You can individually adjust the amount of reverb that is applied to the main, dual, and split voices. If you press the CATEGORY [▲] or [▼] button a number of times in step 2 of the above procedure, the items listed below will appear. You can then use the dial to adjust the reverb send level for the selected voice (refer to page 70 for details).

- **M. Reverb Level** Main voice reverb send level.
- **D. Reverb Level** Dual voice reverb send level.
- **S. Reverb Level** Split voice reverb send level.

Adding Chorus

The chorus effect creates a thick sound that is similar to many of the same voices being played in unison. When you select a style or song the optimum chorus type for the voice used is automatically selected. If you want to select a different chorus type, use the procedure described below.

- 1 Press the [FUNCTION] button to call up the FUNCTION display.

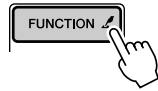

- 2 Use the CATEGORY [▲] and [▼] buttons to select the Chorus Type item.

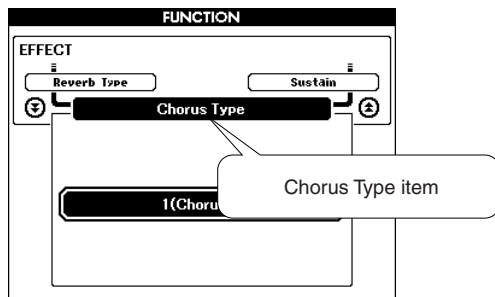
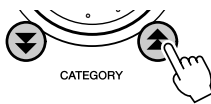

- 3 Use the dial to select a chorus type.

You can check how the selected chorus type sounds by playing on the keyboard.

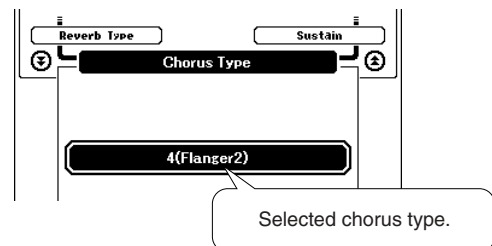
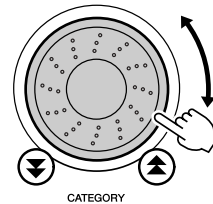

● Adjusting the Chorus Send Level

You can individually adjust the amount of chorus that is applied to the main, dual, and split voices. If you press the CATEGORY [▲] or [▼] button a number of times in step 2 of the above procedure, the items listed below will appear. You can then use the dial to adjust the chorus send level for the selected voice (refer to page 70 for details).

- **M. Chorus Level** Main voice chorus send level.
- **D. Chorus Level** Dual voice chorus send level.
- **S. Chorus Level** Split voice chorus send level.

The Metronome

The metronome can be set for up to 15-beat time signatures. A chime will sound on the first beat of each measure, while a metronome “click” will sound on all others. You can also set the time signature to “00,” in which case the chime will not sound and the “click” sound will be heard on all beats.

The metronome will automatically be set to match the time signature and tempo of the selected song or style, but you can also change the tempo and time signature yourself.

1 Press the [METRONOME] button to start the metronome.

You can stop the metronome by pressing the [METRONOME] button a second time.



2 Press the [TEMPO/TAP] button to call up the TEMPO display.

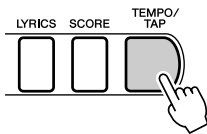

3 Use the dial or the [0] – [9] number buttons to select a tempo from 032 to 280 quarter-note beats per minute.

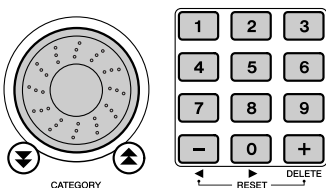

4 Press and hold the [METRONOME] button for longer than a second so that the FUNCTION display Time Signature item appears.

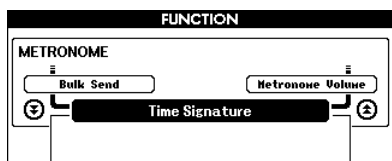

NOTE

You can also access the Time Signature item by pressing the [FUNCTION] button and using the CATEGORY [▲] and [▼] buttons to locate the item (page 70).

5 Use the dial or the [0] – [9] number buttons to select a time signature between 00 and 15 beats per measure.

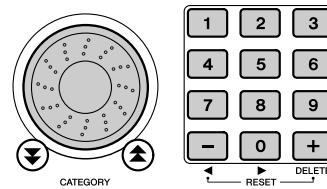

Adjusting the Metronome Volume

6 Press the [FUNCTION] button to call up the FUNCTION display.

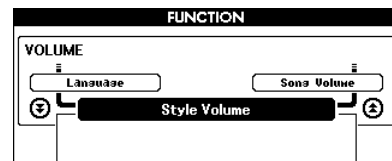
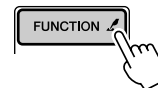

7 Use the CATEGORY [▲] and [▼] buttons to select the Metronome Volume item.

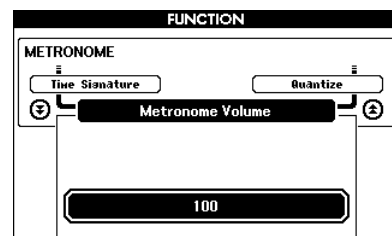
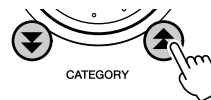

8 Use the dial or the [0] – [9] number buttons to set the metronome volume as required.

Touch Response Sensitivity

When touch response is on you can adjust the sensitivity of the keyboard in response to keyboard dynamics in three steps.

1 Press the [TOUCH] button to turn touch response on.

The touch response icon will appear in the display when touch response is on (pages 27, 53).

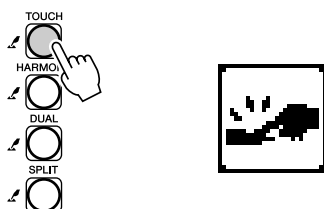

2 Press and hold the [TOUCH] button for longer than a second so that the FUNCTION display Touch Sensitivity item appears.

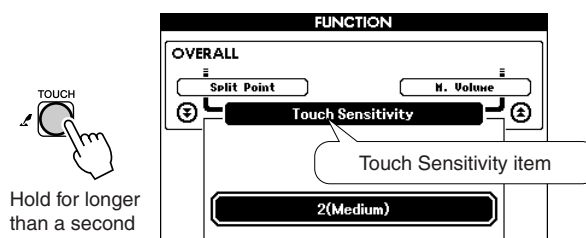

3 Use the dial to select a touch sensitivity setting between 1 and 3. Higher values produce greater (easier) volume variation in response to keyboard dynamics – i.e. greater sensitivity.

NOTE

- The initial default touch sensitivity setting is "2."
- You can also access the Touch Sensitivity item by pressing the [FUNCTION] button and using the CATEGORY [▲] and [▼] buttons to locate the item (page 70).

One Touch Setting

Sometimes selecting the ideal voice to play with a song or style can be confusing. The One Touch Setting feature automatically selects a well-balanced voice for you when you select a style or song. Simply select voice number "000" to activate this feature.

1 Select voice number "000" (steps 1 – 2 on page 23).

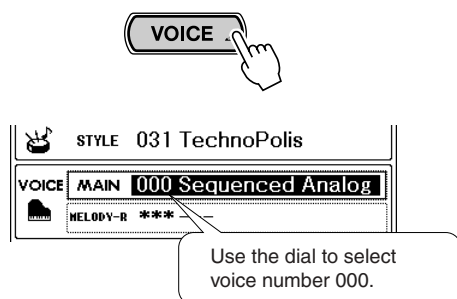

2 Select and play back any song (steps 1 – 3 on page 35).

3 Play the keyboard and remember the sound of the voice.



If you have stopped playback at some point during this procedure press the [START/STOP] button to start playback again.

4 Use the dial to change songs, then play the keyboard and listen to the voice.

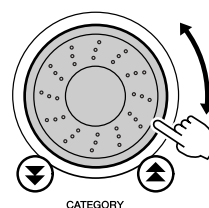

You should hear a different keyboard voice than you played in step 3. Watch the "000" voice name while changing songs and you will see that different voices are selected for each song.

Adjusting the Voice Parameters

Reverb send level, pan, and a variety of other parameters can be individually adjusted for the main, dual, and split voices. Press the [FUNCTION] button to call up the FUNCTION display, and then use the CATEGORY [▲] and [▼] buttons to locate any of the following parameters. Once you have selected an appropriate parameter you can use the dial to adjust its value.

● Main Voice Parameters (page 71)

- **M. Volume** Main voice volume.
- **M. Octave** Main voice octave.
- **M. Pan** Main voice pan.
- **M. Reverb Level** Main voice reverb send level.
- **M. Chorus Level** Main voice chorus send level.

● Dual Voice Parameters (page 71)

- **D. Volume** Dual voice volume.
- **D. Octave** Dual voice octave.
- **D. Pan** Dual voice pan.
- **D. Reverb Level** Dual voice reverb send level.
- **D. Chorus Level** Dual voice chorus send level.

● Split Voice Parameters (page 71)

- **S. Volume** Split voice volume.
- **S. Octave** Split voice octave.
- **S. Pan** Split voice pan.
- **S. Reverb Level** Split voice reverb send level.
- **S. Chorus Level** Split voice chorus send level.

Adjusting the Harmony Volume

The harmony volume level can be adjusted for harmony types 01 (Duet) through 05 (octave).

- 1** Press the [FUNCTION] button to call up the FUNCTION display.

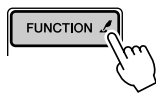

- 2** Use the CATEGORY [▲] and [▼] buttons to select the Harmony Volume item.

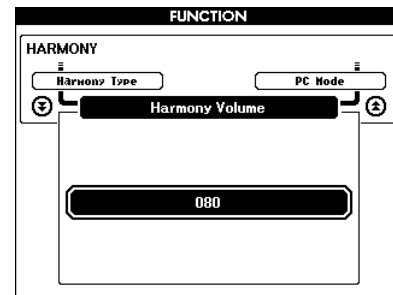
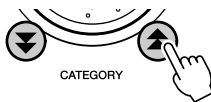

- 3** Use the dial or the [0] – [9] number buttons to set the harmony volume from 000 through 127 as required.

Panel Sustain

This function adds sustain to the keyboard voices. Use it when you want to add sustain to the voices at all times, regardless of footswitch operation.

Press the [FUNCTION] button to call up the FUNCTION display, and then use the CATEGORY [▲] and [▼] buttons to locate the Sustain item. You can then use the [+] and [-] buttons to turn panel sustain on or off.

NOTE

- The sustain of some voices may not be markedly affected when the panel sustain function is turned on.

Style (Auto-accompaniment) Functions

Basic operation of the Style (auto-accompaniment) feature is described on page 29 of the Quick Guide.

Here are some other ways you can play the styles, the style volume adjustment procedure, how you can play chords using the styles, and more.

Setting the Split Point

The initial default split point is key number 54 (the F#2 key), but you can change it to another key using the procedure described below.

- 1 Press the [STYLE] button or the [EASY SONG ARRANGER] button.
- 2 Press and hold the [ACMP ON/OFF] for longer than a second so that the FUNCTION display Split point item appears.

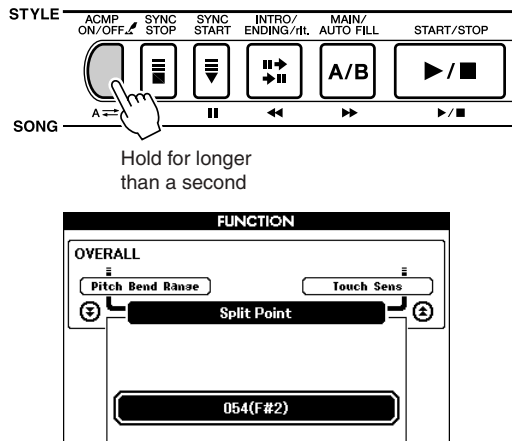

NOTE

- The FUNCTION display Split point item can only be accessed by pressing and holding the [ACMP ON/OFF] button when either the [STYLE] button or the [EASY SONG ARRANGER] is engaged and lit.

- 3 Use the dial or the [0] – [9] number buttons to set the split point to any key from 000 (C-2) through 127 (G8).

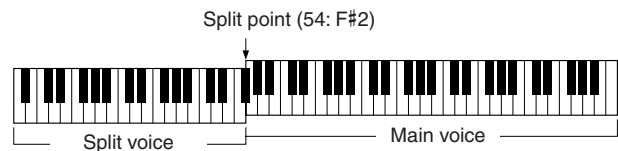

NOTE

- When you change the split point the auto-accompaniment split point also changes.
- The split point cannot be changed during a song lesson.
- The split voice sounds when the split-point key is played.

NOTE

- You can also access the Split Point item by pressing the [FUNCTION] button and using the CATEGORY [▲] and [▼] buttons to locate the item (page 70).

Play Only the Style Rhythm

Style playback is alternately turned on and off each time the [ACMP ON/OFF] button is pressed.

If you use the [ACMP ON/OFF] button to turn style playback off, only the rhythm (percussion) parts will play when the style is started.

Press the [STYLE] button to engage the style function.

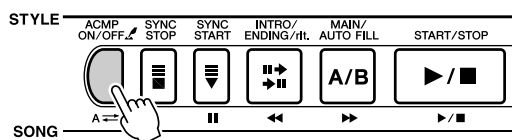

ACMP indicator not showing

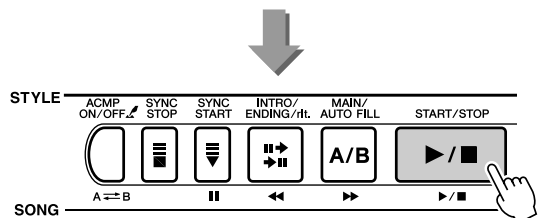

NOTE

- Since style numbers 112 and 124 – 135 (Pianist) have no rhythm parts, no rhythm will play when you start these styles.

Play a Style With Chords but No Rhythm (Stop Accompaniment)

When auto accompaniment is on (the ACMP icon is showing) and Synchro Start is off (the [START/STOP] button is not flashing), you can play chords in the left-hand accompaniment range of the keyboard while the style is stopped and still hear the accompaniment chords. This is “Stop Accompaniment,” and any of the chord fingerings recognized by the instrument can be used (page 61). The chord root and type will be shown on the display. You can also use the Harmony effects with Stop Accompaniment.

Press the [STYLE] button to engage the style function.

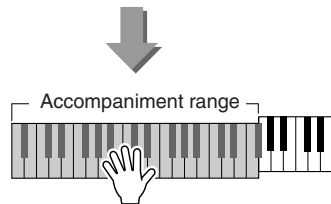
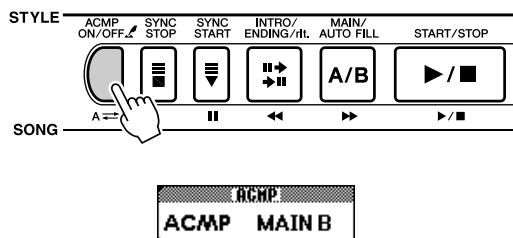

Adjusting the Style Volume

Press the [STYLE] button to engage the style function.

- 1 Press the [FUNCTION] button to call up the FUNCTION display.

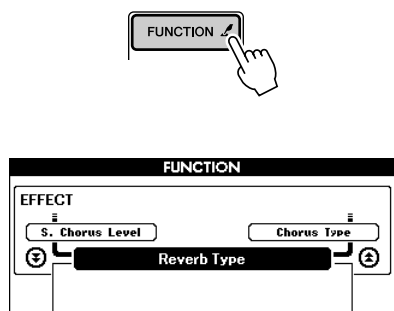

- 2 Use the CATEGORY [▲] and [▼] buttons to select the Style Volume item.

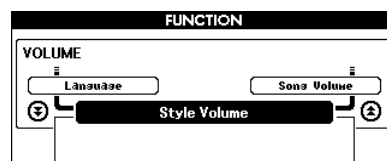
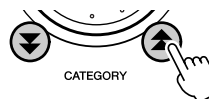

- 3 Use the dial or the [0] – [9] number buttons to set the style volume between 000 and 127 as required.

About Style Number 136

Style number 136 shown on the panel Style List is for use with external style files. “External style files” are style files that you can download from the Internet or acquire from other sources. This instrument can use style files that have the “.sty” file name extension. Use your computer to transfer (page 82) the style file to SmartMedia memory, then the style file can be loaded into the instrument’s style number 136 from the SmartMedia memory card (page 77).

Playing Auto-accompaniment Chords

There are two ways of playing auto-accompaniment chords:

- **Easy Chords**
- **Standard Chords**

The instrument will automatically recognize the different chord types. The function is called Multi Fingering.

The keyboard to the left of the split point (default: 54/F#2) is the “accompaniment range.” Play the accompaniment chords in this area of the keyboard.

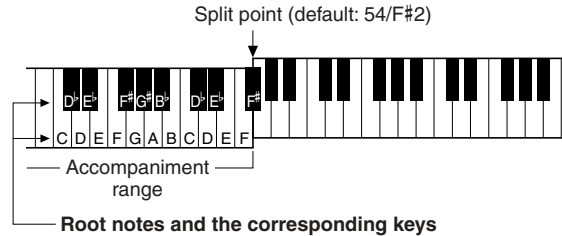

■ Easy Chords.....

This method lets you easily play chords in the accompaniment range of the keyboard using only one, two, or three fingers.

C 	<ul style="list-style-type: none"> ● To play a major chord Press the root note of the chord.
C_m 	<ul style="list-style-type: none"> ● To play a minor chord Press the root note together with the nearest black key to the left of it.
C₇ 	<ul style="list-style-type: none"> ● To play a seventh chord Press the root note together with the nearest white key to the left of it.
C_{m7} 	<ul style="list-style-type: none"> ● To play a minor seventh chord Press the root note together with the nearest white and black keys to the left of it (three keys altogether).

■ Standard Chords.....

This method lets you produce accompaniment by playing chords using normal fingerings in the accompaniment range of the keyboard.

● **How to play Standard Chords [Example for “C” chords]**

C 	C⁽⁹⁾ 	C₆ 	C₆⁽⁹⁾
C_{M7} 	C_{M7}⁽⁹⁾ 	C_{M7}^(#11) 	C^(b5)
C_{M7}^(b5) 	C_{sus4} 	C_{aug} 	C_{M7aug}
C_m 	C_m⁽⁹⁾ 	C_{m6} 	C_{m7}
C_{m7}⁽⁹⁾ 	C_{m7}⁽¹¹⁾ 	C_{mM7} 	C_{mM7}⁽⁹⁾
C_{m7}^(b5) 	C_{mM7}^(b5) 	C_{dim} 	C_{dim7}
C₇ 	C₇^(b9) 	C₇^(b13) 	C₇⁽⁹⁾
C₇^(#11) 	C₇⁽¹³⁾ 	C₇^(#9) 	C₇^(b5)
C_{7aug} 	C_{7sus4} 	C_{7sus2} 	

* Notes enclosed in parentheses () are optional; the chords will be recognized without them.

■ Recognized Standard Chords

All chords in the chart are “C-root” chords.

Chord Name/[Abbreviation]	Normal Voicing	Chord (C)	Display
Major [M]	1 - 3 - 5	C	C
Add ninth [(9)]	1 - 2 - 3 - 5	C ⁽⁹⁾	C9
Sixth [6]	1 - (3) - 5 - 6	C ₆	C6
Sixth ninth [6(9)]	1 - 2 - 3 - (5) - 6	C ₆ ⁽⁹⁾	C6 ⁹ *
Major seventh [M7]	1 - 3 - (5) - 7 or 1 - (3) - 5 - 7	CM7	CM7
Major seventh ninth [M7(9)]	1 - 2 - 3 - (5) - 7	CM ₇ ⁽⁹⁾	CM7 ⁹ *
Major seventh add sharp eleventh [M7(#11)]	1 - (2) - 3 - #4 - 5 - 7 or 1 - 2 - 3 - #4 - (5) - 7	CM ₇ ^(#11)	CM7 ^{#11} *
Flatted fifth [(b5)]	1 - 3 - b5	C ^(b5)	C ^{b5} *
Major seventh flatted fifth [M7b5]	1 - 3 - b5 - 7	CM ₇ ^(b5)	CM7 ^{b5} *
Suspended fourth [sus4]	1 - 4 - 5	C _{sus4}	C _{sus4}
Augmented [aug]	1 - 3 - #5	C _{aug}	C _{aug}
Major seventh augmented [M7aug]	1 - (3) - #5 - 7	CM _{7aug}	CM7 _{aug} *
Minor [m]	1 - b3 - 5	C _m	C _m
Minor add ninth [m(9)]	1 - 2 - b3 - 5	C _m ⁽⁹⁾	C _m 9
Minor sixth [m6]	1 - b3 - 5 - 6	C _{m6}	C _m 6
Minor seventh [m7]	1 - b3 - (5) - b7	C _{m7}	C _m 7
Minor seventh ninth [m7(9)]	1 - 2 - b3 - (5) - b7	C _{m7} ⁽⁹⁾	C _m 7 ⁹
Minor seventh add eleventh [m7(11)]	1 - (2) - b3 - 4 - 5 - (b7)	C _{m7} ⁽¹¹⁾	C _m 7 ¹¹ *
Minor major seventh [mM7]	1 - b3 - (5) - 7	C _m M7	C _m M7
Minor major seventh ninth [mM7(9)]	1 - 2 - b3 - (5) - 7	C _m M ₇ ⁽⁹⁾	C _m M7 ⁹ *
Minor seventh flatted fifth [m7b5]	1 - b3 - b5 - b7	C _{m7} ^(b5)	C _m 7 ^{b5}
Minor major seventh flatted fifth [mM7b5]	1 - b3 - b5 - 7	C _m M ₇ ^(b5)	C _m M7 ^{b5} *
Diminished [dim]	1 - b3 - b5	C _{dim}	C _{dim}
Diminished seventh [dim7]	1 - b3 - b5 - 6	C _{dim7}	C _{dim7}
Seventh [7]	1 - 3 - (5) - b7 or 1 - (3) - 5 - b7	C ₇	C ₇
Seventh flatted ninth [7(b9)]	1 - b2 - 3 - (5) - b7	C ₇ ^(b9)	C ₇ ^{b9}
Seventh add flatted thirteenth [7(b13)]	1 - 3 - 5 - b6 - b7	C ₇ ^(b13)	C ₇ ^{b13}
Seventh ninth [7(9)]	1 - 2 - 3 - (5) - b7	C ₇ ⁽⁹⁾	C ₇ ⁹
Seventh add sharp eleventh [7(#11)]	1 - (2) - 3 - #4 - 5 - b7 or 1 - 2 - 3 - #4 - (5) - b7	C ₇ ^(#11)	C ₇ ^{#11}
Seventh add thirteenth [7(13)]	1 - 3 - (5) - 6 - b7	C ₇ ⁽¹³⁾	C ₇ ¹³
Seventh sharp ninth [7(#9)]	1 - #2 - 3 - (5) - b7	C ₇ ^(#9)	C ₇ ^{#9}
Seventh flatted fifth [7b5]	1 - 3 - b5 - b7	C ₇ ^{b5}	C ₇ ^{b5} *
Seventh augmented [7aug]	1 - 3 - #5 - b7	C _{7aug}	C _{7aug}
Seventh suspended fourth [7sus4]	1 - 4 - (5) - b7	C _{7sus4}	C _{7sus4}
Suspended second [sus2]	1 - 2 - 5	C _{sus2}	C _{sus2} *

* These chords are not shown in the Dictionary function.

NOTE

- Notes in parentheses can be omitted.
- Playing two same root keys in the adjacent octaves produces accompaniment based only on the root.
- A perfect fifth (1 + 5) produces accompaniment based only on the root and fifth which can be used with both major and minor chords.
- The chord fingerings listed are all in “root” position, but other inversions can be used — with the following exceptions: m7, m7b5, 6, m6, sus4, aug, dim7, 7b5, 6(9), sus2.

NOTE

- Inversion of the 7sus4 and m7(11) chords are not recognized if the notes shown in parentheses are omitted.
- The auto accompaniment will sometimes not change when related chords are played in sequence (e.g. some minor chords followed by the minor seventh).
- Two-note fingerings will produce a chord based on the previously played chord.

Looking Up Chords Using the Chord Dictionary

The Dictionary function is essentially a built-in “chord book” that shows you the individual notes of chords. It is ideal when you know the name of a certain chord and want to quickly learn how to play it.

- 1 Press and hold the [LESSON MODE] button for longer than a second. The DICTIONARY display will appear.

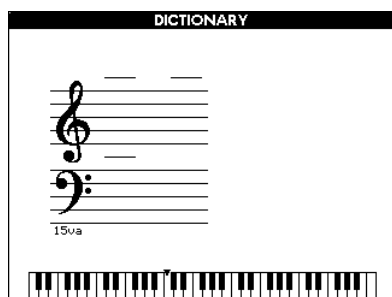
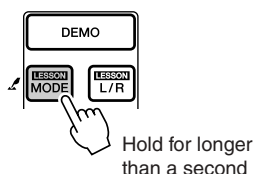

- 2 As an example, we'll learn how to play a GM7 (G major seventh) chord. Press the “G” key in the section of the keyboard labeled “CHORD ROOT.” (The note doesn't sound.) The root note you set is shown in the display.

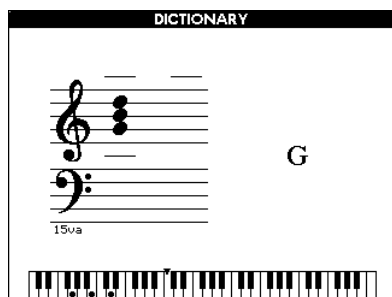
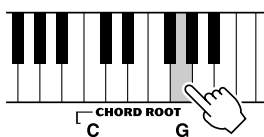

- 3 Press the “M7” (major seventh) key in the section of the keyboard labeled “CHORD TYPE.” (The note doesn't sound.) The notes you should play for the specified chord (root note and chord type) are shown in the display, both as notation and in the keyboard diagram.

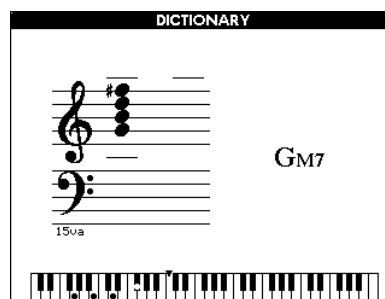
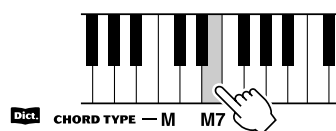

To call up possible inversions of the chord, press the [+]/[-] buttons.

NOTE

- About major chords: Simple major chords are usually indicated only by the root note. For example, “C” refers to C major. However, when specifying major chords here, make sure to select “M” (major) after pressing the root note.

NOTE

- Be aware that the chord types explained here are the left-hand notes applied to various styles and different from the one for the performance assistant technology feature.

- 4 Try playing a chord in the auto accompaniment section of the keyboard, checking the indications in the display. When you've played the chord properly, a bell sound signals your success and the chord name in the display is highlighted.

■ Chord Basics

Two or more notes played together constitute a “chord.”

The most basic chord type is the “triad” consisting of three notes: the root, third, and fifth degrees of the corresponding scale. A C major triad, for example, is made up of the notes C (the root), E (the third note of the C major scale), and G (the fifth note of the C major scale).

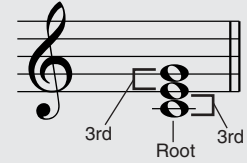

In the C major triad shown above, the lowest note is the “root” of the chord (this is the chord’s “root position” ... using other chord notes for the lowest note results in “inversions”). The root is the central sound of the chord, which supports and anchors the other chord notes.

The distance (interval) between adjacent notes of a triad in root position is either a major or minor third.

Major third – four half steps (semitones)

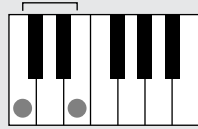

Minor third – three half steps (semitones)

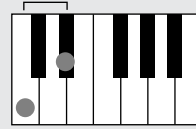

The lowest interval in our root-position triad (between the root and the third) determines whether the triad is a major or minor chord, and we can shift the highest note up or down by a semitone to produce two additional chords, as shown below.

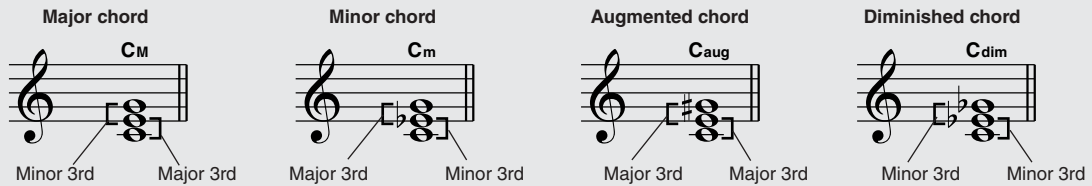

The basic characteristics of the chord sound remain intact even if we change the order of the notes to create different inversions. Successive chords in a chord progression can be smoothly connected, for example, by choosing the appropriate inversions (or chord “voicings”).

● Reading Chord Names

Chord names tell you just about everything you need to know about a chord (other than the inversion/voicing). The chord name tells you what the root of the chord is, whether it is a major, minor, or diminished chord, whether it requires a major or flatted seventh, what alterations or tensions it uses ... all at a glance.

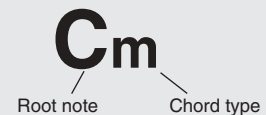

● Some Chord Types (These are just some of the “Fingered” chord types recognized by the DGX-505/305.)

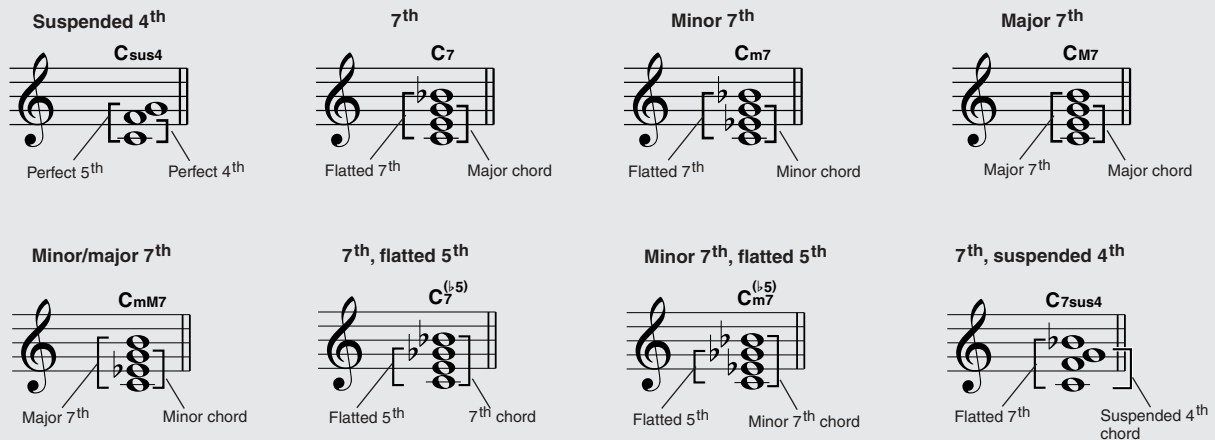

Song Settings

Song Volume

1 Press the [FUNCTION] button to call up the FUNCTION display.

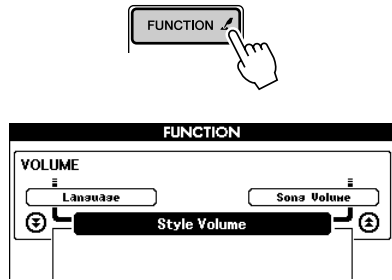

2 Use the CATEGORY [▲] and [▼] buttons to select the Song Volume item.

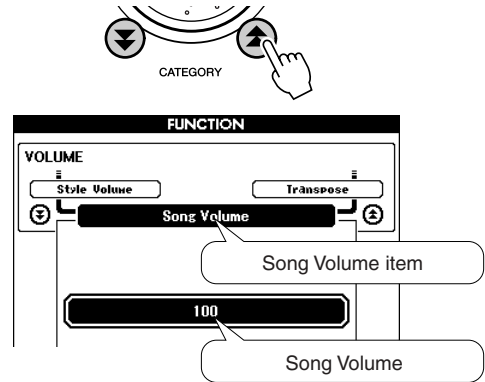

3 Use the dial or the [0] – [9] number buttons to set the song volume between 000 and 127 as required.

NOTE

- Song volume can be adjusted while a song is selected.

A-B Repeat

You can specify a section of a song – “A” is the start point and “B” is the end point – for repeat playback.



1 Play the song (page 35) and press the [A ⇌ B] button at the beginning of the section you want to repeat (the “A” point).

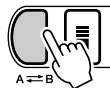

2 Press the [A ⇌ B] button a second time at the end of the section you want to repeat (the “B” point).

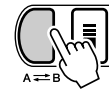

3 The specified A-B section of the song will now play repeatedly.

You can stop repeat playback at any time by pressing the [A ⇌ B] button.

NOTE

- The repeat start and end points can be specified in one-measure increments.
- The current measure number is shown in the upper right corner of the display during playback.
- If you want to set the start point “A” at the very beginning of the song press the [A ⇌ B] button before starting playback of the song.

Muting Independent Song Parts

Each “track” of a song plays a different part of the song – melody, percussion, accompaniment, etc. You can mute individual tracks and play the muted part on the keyboard yourself, or simply mute tracks other than the ones you want to listen to. Use the SONG MEMORY [1] – [5] and [A] buttons to mute or un-mute the corresponding tracks. The border around the track number in the display disappears when that track is muted. Refer to page 45 for information about the song track configuration.



No track number ... no data.



Track number without border ... track contains data but is muted.

Track number with border ... track contains data and is not muted.

Change the Key Of a Song

◆ Large Pitch Changes (Transpose)

The overall pitch of the instrument can be shifted up or down by a maximum of 1 octave in semitone increments.

- 1 Press the [FUNCTION] button to call up the FUNCTION display.

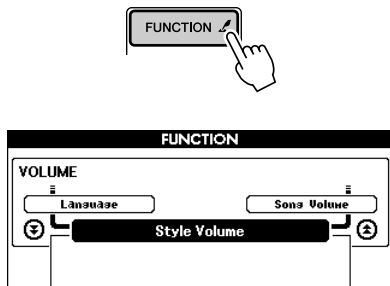

- 2 Use the CATEGORY [▲] and [▼] buttons to select the Transpose item.

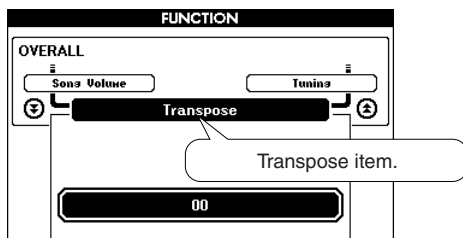

- 3 Use the dial or the [0] – [9] number buttons to set the transpose value between -12 and +12 as required.

NOTE

• The pitch of Drum Kits voices cannot be changed.

◆ Small Pitch Changes (Tuning)

The overall tuning of the instrument can be shifted up or down by a maximum of 100 cents in 1-cent increments (100 cents = 1 semitone).

- 1 Press the [FUNCTION] button to call up the FUNCTION display.

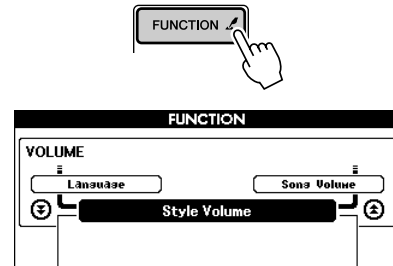

- 2 Use the CATEGORY [▲] and [▼] buttons to select the Tuning item.

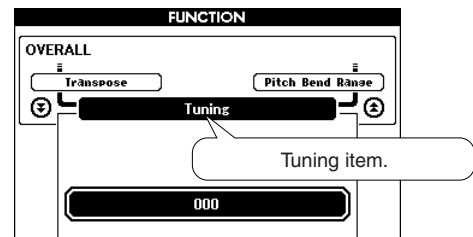

- 3 Use the dial or the [0] – [9] number buttons to set the tuning as required.

NOTE

• The pitch of Drum Kits voices cannot be changed.

Song Fast Forward, Fast Reverse, and Pause

These are just like the transport controls on a cassette deck or CD player, letting you fast forward [▶▶], rewind [◀◀] and pause [||] playback of the song.

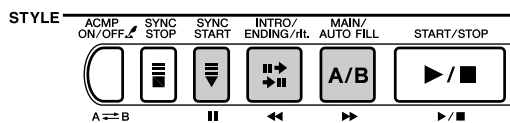

Press the pause button to pause playback.

Press the fast reverse button rapidly return to an earlier point in the song.

Press the fast forward button to rapidly skip ahead to a later point in the song.

NOTE

• When an A-B repeat range is specified the fast reverse and forward function will only work within that range.

Change the Melody Voice

You can change a song's melody voice to any other voice you prefer.

This setting can be made independently for the right-hand melody (MELODY R) and left-hand melody (MELODY L) voices.

NOTE

- You cannot change the melody voice of a user song.

Press the [SONG] button to engage the song mode.

- 1 Press and hold the [VOICE] button for longer than a second to display the voice list.



- 2 Press the [VOICE] button as many times as necessary so that "VOICE SELECT (MELODY R)" or "VOICE SELECT (MELODY L)" appears as the voice list title.

Each time the [VOICE] button is pressed the voice list title changes in sequence: MAIN → DUAL → SPLIT → MELODY R → MELODY L → MAIN ...

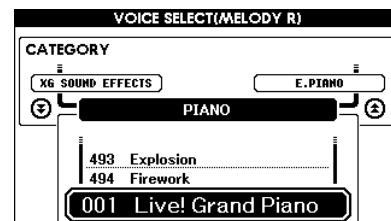

- 3 Use the dial or other selection controls to select a voice.

Media Select

The DGX-505/305 can use two different types of memory media to store external song files transferred from a computer – SmartMedia and flash memory (songs 036 –). The media select function determines to which media type song files will be stored, and from which media type stored song files will be played. A flowchart of the process from saving song files to memory media and playing them back is provided on page 36.

- 1 Press the [FUNCTION] button to call up the FUNCTION display.

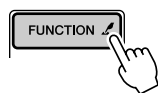

- 2 Use the CATEGORY [▲] and [▼] buttons to select the Media Select item.

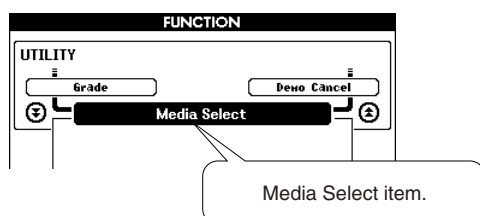
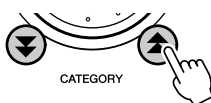

- 3 Use [+] and [-] buttons to select SmartMedia or Flash Memory.

Press the [+] button to select SmartMedia when you want to save a song to SmartMedia or play a saved song from SmartMedia memory. Press the [-] button to select Flash Memory when you want to save a song to flash memory or play a saved song from flash memory.

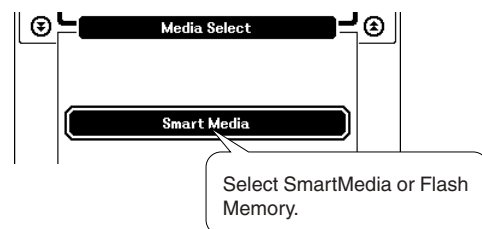

- 4 Press the [EXIT] button to return to the MAIN display.

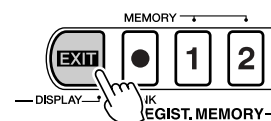

Memorize Your Favorite Panel Settings

This instrument has a **Registration Memory** feature that lets you save your favorite settings for easy recall whenever they're needed. Up to 16 complete setups can be saved (8 banks of two setups each).

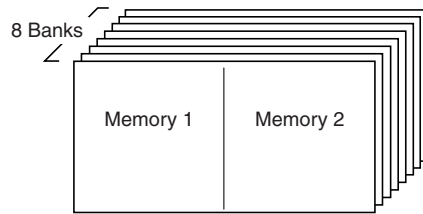

Up to 16 presets (eight banks of two each) can be memorized.

Saving Settings to the Registration Memory

■ Settings That Can be Saved to the Registration Memory

- **Style settings***
Style number, Auto Accompaniment ON/OFF, Split Point, Style settings (Main A/B), Style Volume, Tempo
- **Voice settings**
Main Voice setting (Voice number, Volume, Octave, Pan, Reverb Send Level, Chorus Send Level), Dual Voice settings (Dual ON/OFF, Voice number, Volume, Octave, Pan, Reverb Send Level, Chorus Send Level), Split Voice settings (Split ON/OFF, Voice number, Volume, Octave, Pan, Reverb Send Level, Chorus Send Level)
- **Effect settings**
Reverb Type, Chorus Type, Panel Sustain ON/OFF
- **Harmony settings**
Harmony ON/OFF, Harmony Type, Harmony Volume
- **Other settings**
Transpose, Pitch Bend Range

* Style settings are not available for Registration Memory when using the Song features.

■ Saving to the Registration Memory

- 1** Set the panel controls as required – select a voice, accompaniment style, etc.
- 2** Press the [●] (MEMORY/BANK) button. A bank number will appear in the display when you release the button.

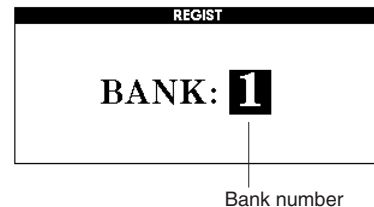
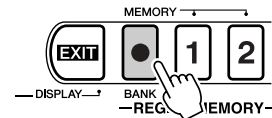

- 3** Use the dial or the [1] – [8] number buttons to select a bank number from 1 to 8.

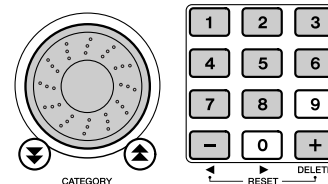

NOTE

- Data cannot be saved to the registration memory during song playback.

4 Press the REGIST. MEMORY [1] or [2] button while holding the [●] (MEMORY/BANK) button to store the current panel settings to the specified registration memory.

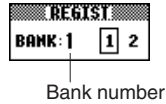
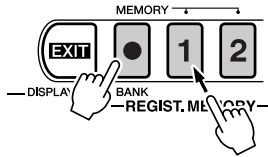

NOTE

- You can also save your panel settings memorized to registration memory button into SmartMedia memory as the user data file.

NOTE

- If you select a Registration Memory setting that has already been created, the previous data is deleted and overwritten with the new data.

CAUTION

- Do not turn off the power while saving settings to the registration memory, otherwise the data may be damaged or lost.

Recalling a Registration Memory.....

1 Press the [●] (MEMORY/BANK) button. A bank number will appear in the display when you release the button.

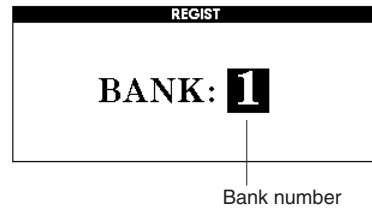
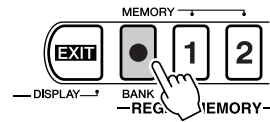

2 Use the dial or the [1] – [8] number buttons to select bank you want to recall.

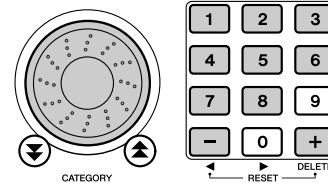

3 Press the REGIST. MEMORY button, [1] or [2], containing the settings you want to recall. The panel controls will be instantly set accordingly.

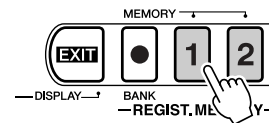

Function settings

The Function pages that can be accessed via the **FUNCTION** display include detailed settings for the instrument's voices, effects, split point, tuning, and more. Button shortcuts can be used to quickly access commonly used settings: hold a shortcut button for longer than a second to directly access the related setting display.

Locating and Editing the Function Settings

1 Press the **[FUNCTION]** button to call up the **FUNCTION** display.

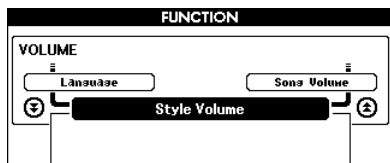
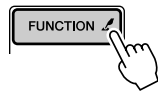

2 Use the **CATEGORY** [**▲**] and [**▼**] buttons to select the required item.

For details on individual settings refer to the **FUNCTION Setting List** on page 71.

The name of the previous item in the list appears to the upper left, and the name of the next item in the list appears to the upper right of the currently selected item.

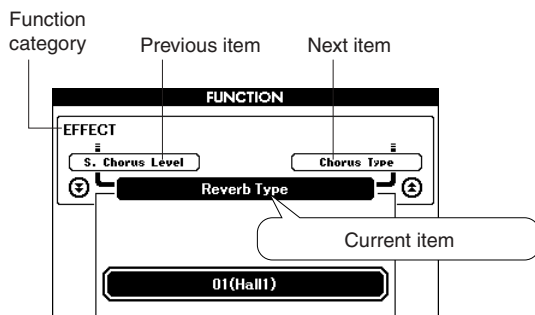
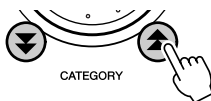

3 Set the value as required using the dial, the **[+]** and **[-]** buttons, or the **[0] – [9]** number buttons.

For ON/OFF settings use the **[+]** button to turn the function ON and the **[-]** button to turn the function OFF. Use the **[+]** button to begin execution of operations, or the **[-]** button to cancel the selected operation.

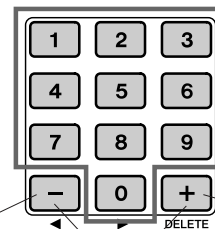

Directly enter numeric values

- Decrease a value by 1
- Turn a setting OFF
- Cancel an operation

Reset a value to its default setting

- Increase a value by 1
- Turn a setting ON
- Execute an operation

4 If necessary, hold the **[FUNCTION]** button for longer than a second to save your settings to flash memory.

Although all settings made via the **FUNCTION** display are retained by the instrument while the power is on, your custom settings will be lost when the power is turned off unless you save them to flash memory. Simply save the settings to flash memory by holding the **[FUNCTION]** button for more than a second, and your settings will be retained in flash memory even while the power is off and will be recalled the next time the instrument is turned on.

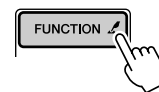

Hold for longer than a second

CAUTION

- Do not turn off the power while saving settings, otherwise the data may be damaged or lost.

■ Function Display List

Category	Setting	Item title	Range/Settings	Description
VOLUME	Style Volume	Style Volume	000 – 127	Determines the volume of the Style.
	Song Volume	Song Volume	000 – 127	Determines the volume of the Song.
OVERALL	Transpose	Transpose	-12 – 12	Determines the pitch of the instrument by semitone increments.
	Tuning	Tuning	-100 – 100	Sets the pitch of the instrument's sound in 1-cent increments.
	Pitch Bend Range	Pitch Bend Range	01 – 12	Sets the pitch bend range in semitone increments.
	Split Point	Split Point	000 – 127 (C-2 – G8)	Determines the highest key for the Split voice and sets the Split "point" — in other words, the key that separates the Split (lower) and Main (upper) voices. The Split Point setting and Accompaniment Split Point setting are automatically set to the same value.
	Touch Sensitivity	Touch Sensitivity	1 (Soft)/2 (Medium)/3 (Hard)	When Touch Response is on, this determines the sensitivity of the feature.
MAIN VOICE	Volume	M. Volume	000 – 127	Determines the volume of the Main voice.
	Octave	M. Octave	-2 – +2	Determines the octave range for the Main voice.
	Pan	M. Pan	000 (left) – 64 (center) – 127 (right)	Determines the pan position of the Main voice in the stereo image. The value "0" results in the sound being panned full left; the value "127" results in the sound being panned full right.
	Reverb Send Level	M. Reverb Level	000 – 127	Determines how much of the Main voice's signal is sent to the Reverb effect.
	Chorus Send Level	M. Chorus Level	000 – 127	Determines how much of the Main voice's signal is sent to the Chorus effect.
DUAL VOICE	Volume	D. Volume	000 – 127	Determines the volume of the Dual voice.
	Octave	D. Octave	-2 – +2	Determines the octave range for the Dual voice.
	Pan	D. Pan	000 (left) – 64 (center) – 127 (right)	Determines the pan position of the Dual voice in the stereo image. The value "0" results in the sound being panned full left; the value "127" results in the sound being panned full right.
	Reverb Send Level	D. Reverb Level	000 – 127	Determines how much of the Dual voice's signal is sent to the Reverb effect.
	Chorus Send Level	D. Chorus Level	000 – 127	Determines how much of the Dual voice's signal is sent to the Chorus effect.
SPLIT VOICE	Volume	S. Volume	000 – 127	Determines the volume of the Split voice.
	Octave	S. Octave	-2 – +2	Determines the octave range for the Split voice.
	Pan	S. Pan	000 (left) – 64 (center) – 127 (right)	Determines the pan position of the Split voice in the stereo image. The value "0" results in the sound being panned full left; the value "127" results in the sound being panned full right.
	Reverb Send Level	S. Reverb Level	000 – 127	Determines how much of the Split voice's signal is sent to the Reverb effect.
	Chorus Send Level	S. Chorus Level	000 – 127	Determines how much of the Split voice's signal is sent to the Chorus effect.
EFFECT	Reverb Type	Reverb Type	01 – 10	Determines the Reverb type, including off (10). (See the list on page 104)
	Chorus Type	Chorus Type	01 – 05	Determines the Chorus type, including off (05). (See the list on page 104)
	Panel Sustain	Sustain	ON/OFF	Determines whether or not panel sustain is always applied to the MAIN/DUAL/SPLIT voices. Panel sustain is applied continuously when ON, or not applied when OFF. (page 58)
HARMONY	Harmony Type	Harmony Type	01 – 26	Determines the Harmony type. (See the list on page 104)
	Harmony Volume	Harmony Volume	000 – 127	Determines the level of the Harmony effect when Harmony type 1-5 is selected.

Category	Setting	Item title	Range/Settings	Description
PC MODE	PC mode	PC Mode	PC1/PC2/OFF	Optimizes the MIDI settings when you connect to a computer (page 80). PC1 sets local off and external clock on for use with an external sequencer or similar device. The PC2 setting allows the instrument to use Digital Music Notebook content on the connected computer. OFF turns local control on, external clock off, keyboard out on, style out on, and song out on.
MIDI	Local On/Off	Local On/Off	ON/OFF	Determines whether the instrument's keyboard controls the internal tone generator (ON) or not (OFF). (page 80)
	External Clock	External Clock	ON/OFF	Determines whether the instrument synchronizes to the internal clock (OFF) or an external clock (ON). (page 80)
	Keyboard Out	Keyboard Out	ON/OFF	Determines whether Keyboard performance data of the instrument is transmitted (ON) or not (OFF).
	Style Out	Style Out	ON/OFF	Determines whether Style data is transmitted (ON) via USB or not (OFF) during Style playback.
	Song Out	Song Out	ON/OFF	Determines whether Song data is transmitted (ON) via USB or not (OFF) during Song playback.
	Initial Setup Send	Initial Setup Send	YES/NO	Lets you send the data of the panel settings to a computer. Press [+] to send, or press [-] to cancel. Use the [+] button to transmit the data. Use the [-] button to stop the transmission.
	Bulk Send	Bulk Send	YES/NO	Transfers user song and registration memory data from the instrument to a computer. The [+] button begins the transfer, and the [-] button aborts the transfer.
METRONOME	Time Signature	Time Signature	00 – 15	Determines the time signature of the Metronome.
	Metronome Volume	Metronome Volume	000 – 127	Determines the volume of the Metronome.
SCORE	Quantize	Quantize		Depending on the song data, you can make the score more readable by adjusting the timing of the notes. This determines the minimum timing resolution used in the song. For example, if there are both quarter notes and eighth notes in the song, you should set this on a value of "♪" (eighth note). Any notes or rests shorter than this value will not be shown in the score.
LESSON	Lesson Track (R)	R-Part	GuideTrack 1 – 16	Determines the guide track number for your right hand lesson. The setting is only effective for SmartMedia card or flash memory songs (SMF).
	Lesson Track (L)	L-Part	GuideTrack 1 – 16	Determines the guide track number for your left hand lesson. The setting is only effective for SmartMedia card or flash memory songs (SMF).
	Grade	Grade	ON/OFF	Determines whether Grade function is on or off.
UTILITY	Media Select	Media Select	Flash Memory/SmartMedia	Selects a media type for data storage or loading. The available media types are SmartMedia and flash memory.
	Demo Cancel	D-Cancel	ON/OFF	Determines the Demo cancel is enabled or not. When this is set to ON, the Demo Song does not play, even if the [DEMO] button is pressed.
LANGUAGE	Language Select	Language	English/Japanese	Determines the display language for the demo displays, song file names, lyrics and certain display messages. All other messages and names are displayed in English. When this is set to Japanese, the file names are displayed in the Japanese font. The lyrics display follows the language setting originally made in the song data; however, when no such setting exists, the setting here is used.

* All these settings can be conveniently reset to their initial default values by pressing the [+] and [-] buttons simultaneously. (The exception to this is Initial Setup Send and Bulk Send, which is an operation, not a setting.)

Using SmartMedia™ Memory

SmartMedia is a card-type memory medium used for storing data.

When a SmartMedia card is inserted in this instrument's card slot, MIDI data created on the instrument can be saved to or loaded from the memory card. SmartMedia can also be used to transfer song data downloaded from the Internet to the instrument, where it can be used with the performance assistant technology (page 16) and Lesson (page 39) features described in the Quick Guide. Furthermore, user songs saved to SmartMedia memory in MIDI file format can also be used with these features.

In this section we'll look at the procedures for setting up and formatting SmartMedia memory cards, as well as for saving and loading data to and from them.

If you don't have a SmartMedia card, you will need to purchase one (or more, as needed).

Be sure to read the handling SmartMedia precautions provided on page 11.

Inserting a SmartMedia Card

1 Insert a SmartMedia* card into the card slot, being careful to insert it with the proper orientation.

The gold connector terminals on the SmartMedia card should be facing upward. Carefully but firmly insert the card all the way into the slot. Take care not to insert the card the wrong way around.

* This instrument uses 3.3V SmartMedia™ memory cards.

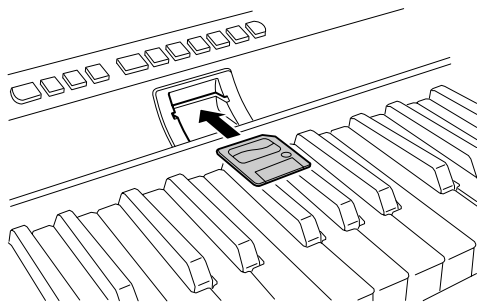

2 Check that the file control icon appears in the MAIN display.

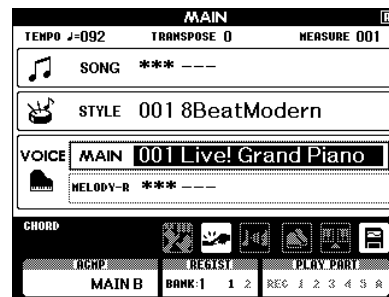

File Control Icon



This icon will appear when a SmartMedia card has been properly inserted and is ready for use.

The file control icon will appear in the MAIN display when a SmartMedia memory card has been inserted and is ready for use. When the file control icon is showing you can access the FILE CONTROL display by pressing the [FILE CONTROL] button. Please don't press the button just yet.

NOTE

- No sound will be produced if you play the keyboard while the FILE CONTROL display is showing. Also, in this state only buttons related to file functions will be active.

NOTE

- The FILE CONTROL display will not appear in any of the following cases:
 - No SmartMedia card has been inserted.
 - The FUNCTION display Media Select item is set to Flash Memory.
 - During style or song playback.
 - During a lesson.
 - While data is being loaded from a SmartMedia card.

Change the Media Select Setting to SmartMedia

In order to perform any SmartMedia operations you will first need to make sure that the FUNCTION display Media Select item is set to SmartMedia. The media select procedure is outlined on page 67. If the FUNCTION Display Media Select item is set to SmartMedia and a SmartMedia card is properly inserted in the instrument's card slot the file control icon will appear in the MAIN display.

- 1** Press the [FUNCTION] button to call up the FUNCTION display.
- 2** Use the CATEGORY [▲] and [▼] buttons to select the Media Select item.

- 3** Press the [+] button to select SmartMedia.

Formatting SmartMedia Cards

New SmartMedia cards must be formatted before they can be used by this instrument.

⚠ CAUTION

- If you format a SmartMedia card that already contains data, all of the data will be erased. Be careful not to erase important data when using the format function.

- 1** After inserting the SmartMedia card to be formatted into the instrument's card slot, check that the file control icon is showing in the MAIN display. If the icon is not showing make sure that the Media Select item is set to SmartMedia.
- 2** Press the [FILE CONTROL] button so that the FILE display Format item appears. The display prompts you for confirmation.

NOTE

- If the Format item does not appear when you access the FILE CONTROL display, use the CATEGORY [▲] and [▼] buttons to locate it.

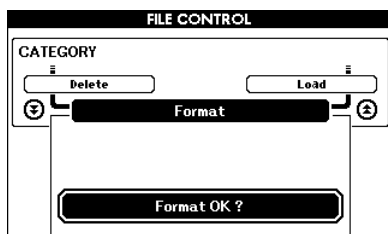

- 3** Press the [EXECUTE] button and the display prompts you for confirmation.

You can press the [-] button at this point to cancel the operation.

- 4** Press the [EXECUTE] button again, or the [+] button, and the format operation will begin.

⚠ CAUTION

- Once the format-in-progress message appears on the display the format operation cannot be canceled. Never turn off the power or remove the SmartMedia card during this operation.

- 5** A message will appear on the display to inform you that the operation has finished.

Press the [EXIT] button to return to the MAIN display.

NOTE

- If the SmartMedia card has been write-protected, an appropriate message will appear on the display and you will not be able to execute the operation.

Saving Data

Three types of data are saved to one “User Data File” by this operation: user song, style file (style number 136), and registration memory data. When you save a user song the style file and registration memory are also saved automatically.

- 1 Make sure that a properly formatted SmartMedia card has been properly inserted into the instrument’s card slot, and that the file control icon is showing in the MAIN display. If the icon is not showing change the Media Select setting to SmartMedia.**
- 2 Press the [FILE CONTROL] button.**
- 3 Use the CATEGORY [\blacktriangle] and [\blacktriangledown] buttons to locate the User File Save item.**
A default file name will automatically be created.

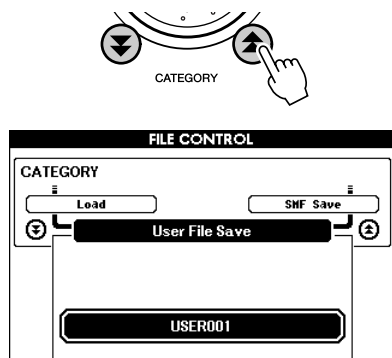

● To Overwrite an Existing File

If you want to overwrite a file that already exists on the SmartMedia card, use the dial or the [+] and [-] buttons to select the file, then skip ahead to step 6.

NOTE

- Up to 100 user files can be saved to a single SmartMedia card.
- If the SmartMedia card has been write-protected, an appropriate message will appear on the display and you will not be able to execute the operation.
- If there is not enough capacity left on the card to save the data an appropriate message will appear on the display and you will not be able to save the data. Erase unwanted files from the card to make more memory available (page 77), or use a different card.
- Refer to the “Messages” list on page 91 for other possible errors that might prevent you from completing the operation.

- 4 Press the [EXECUTE] button. A cursor will appear below the first character in the file name.**

5 Change the file name as necessary.

- The [-] button moves the cursor to the left, and the [0] button moves it to the right.
- Use the dial to select a character for the current cursor location.
- The [+] button deletes the character at the cursor location.

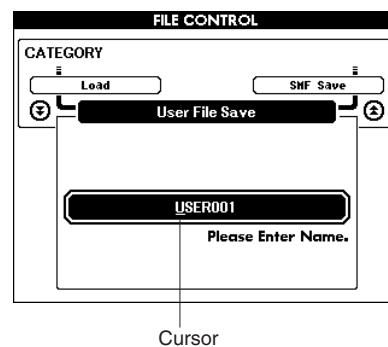
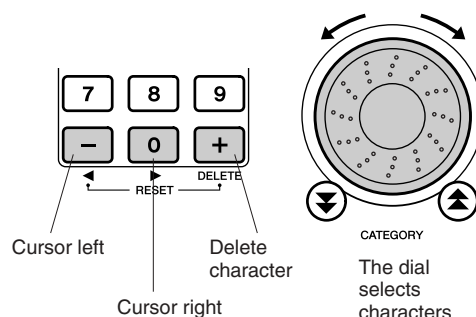

- 6 Press the [EXECUTE] button. The display prompts you for confirmation.**

You can cancel the save operation at this point by pressing the [-] button.

- 7 Press the [EXECUTE] button again, or the [+] button, and the save operation will begin.**

CAUTION

- Once the save-in-progress message appears on the display the operation cannot be canceled. Never turn off the power or remove the SmartMedia card during this operation.

- 8 A message will appear on the display to inform you that the operation has finished.**

Press the [EXIT] button to return to the MAIN display.

NOTE

- If an existing filename is specified the display prompts you for confirmation. Press [EXECUTE] or [+] if it is OK to overwrite the file, or [-] to cancel.
- The amount of time it will take to perform the save operation will depend on the condition of the SmartMedia card.

Convert a User Song to SMF Format and Save

This operation converts a user song (song numbers 031 – 035) to SMF Format 0 and saves the file to SmartMedia.

● What is SMF (Standard MIDI File)?

The SMF (Standard MIDI File) format is one of the most common and widely compatible sequence formats used for storing sequence data. There are two variations: Format 0 and Format 1. A large number of MIDI devices are compatible with SMF Format 0, and most commercially available MIDI sequence data is provided in SMF Format 0.

- 1 Make sure that a properly formatted SmartMedia card has been properly inserted into the instrument's card slot, and that the file control icon is showing in the MAIN display. If the icon is not showing change the Media Select setting to SmartMedia.

- 2 Press the [FILE CONTROL] button.

NOTE

- Up to 894 songs can be saved to a single SmartMedia card.
- This operation cannot be executed if there is no data in any of the instrument's user songs (song numbers 031 – 035).

- 3 Use the CATEGORY [▲] and [▼] buttons to locate the SMF Save item.

The SOURCE FILE – a user song name – will be highlighted.

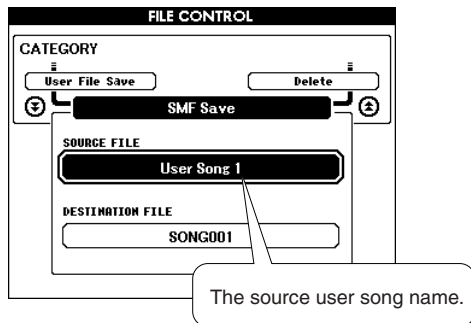
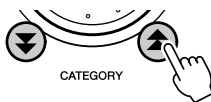

- 4 Select the source user song.

You can press the [+] and [-] buttons simultaneously to select the first user song.

- 5 Press the [EXECUTE] button.

The DESTINATION SONG will be highlighted, and a default name will appear for the converted song file.

● To Overwrite an Existing File

If you want to overwrite a file that already exists on the SmartMedia card, use the dial or the [+] and [-] buttons to select the file, then skip ahead to step 8.

- 6 Press the [EXECUTE] button.

A cursor will appear below the first character in the file name.

- 7 Change the file name as necessary.

Refer to “Saving Data” on page 75 for filename entry.

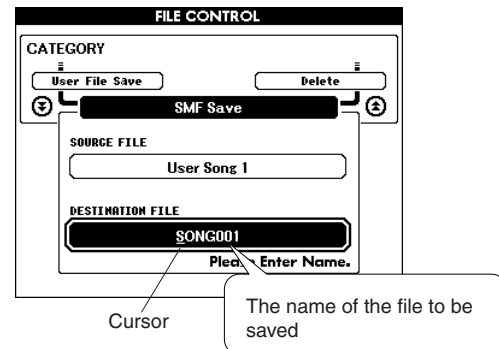

- 8 Press the [EXECUTE] button. The display prompts you for confirmation.

You can cancel the save operation at this point by pressing the [-] button.

- 9 Press the [EXECUTE] button again, or the [+] button, and the save operation will begin.

CAUTION

- Once the save-in-progress message appears on the display the operation cannot be canceled. Never turn off the power or remove the SmartMedia card during this operation.

- 10 A message will appear on the display to inform you that the operation has finished.

Press the [EXIT] button to return to the MAIN display.

NOTE

- If an existing filename is specified the display prompts you for confirmation. Press [EXECUTE] or [+] if it is OK to overwrite the file, or [-] to cancel.
- The amount of time it will take to perform the save operation will depend on the condition of the SmartMedia card.

Loading Saved User data files

This procedure allows you to load user data files you have previously saved to SmartMedia into the instrument's internal memory.

CAUTION

- If you load a User Data File user song (031 – 035), style file (style number 136), and registration memory data will be overwritten by the newly loaded data. If you only load a style file, only the style file will be overwritten. Save important data to a SmartMedia card before loading data that will overwrite it.

- 1 Make sure that the SmartMedia card containing the file(s) you want to load has been properly inserted into the instrument's card slot, and that the file control icon is showing in the MAIN display. If the icon is not showing change the Media Select setting to SmartMedia.
- 2 Press the [FILE CONTROL] button.
- 3 Use the CATEGORY [▲] and [▼] buttons to locate the Load item.

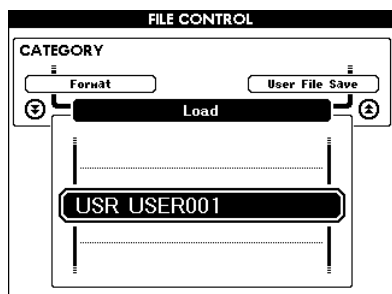
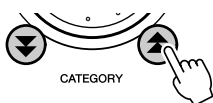

NOTE

- Style files must be located in the root directory. Style files located within folders will not be recognized.

4 Select the file you want to load.

You can press the [+] and [-] buttons simultaneously to select the first file on the SmartMedia card.

NOTE

- If there are no files that can be loaded into the SmartMedia card, and appropriate message will appear on the display and you will not be able to continue with the load operation.

5 Press the [EXECUTE] button. The display prompts you for confirmation.

You can cancel the load operation at this point by pressing the [-] button.

6 Press the [EXECUTE] button again, or the [+] button, and the load operation will begin.

CAUTION

- Once the load-in-progress message appears on the display the operation cannot be canceled. Never turn off the power or remove the SmartMedia card during this operation.

- 7 A message will appear on the display to inform you that the operation has finished. Press the [EXIT] button to return to the MAIN display.

Deleting Data From a SmartMedia Card

This procedure deletes user data files (user songs, style file, and registration memory), SMF-converted songs, and other MIDI song file data from a SmartMedia card.

- 1 Make sure that the SmartMedia card containing the file(s) you want to delete has been properly inserted into the instrument's card slot, and that the file control icon is showing in the MAIN display. If the icon is not showing change the Media Select setting to SmartMedia.
- 2 Press the [FILE CONTROL] button.

- 3 Use the CATEGORY [▲] and [▼] buttons to locate the Delete item.

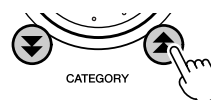

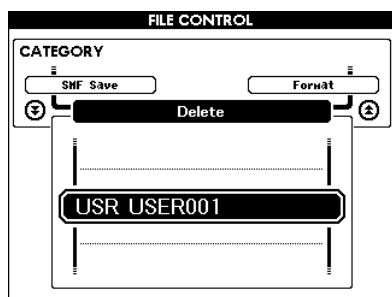

- 4 Select the file you want to delete.**
You can press the [+] and [-] buttons simultaneously to select the first song or user data file on the SmartMedia card.
- 5 Press the [EXECUTE] button. The display prompts you for confirmation.**
You can cancel the delete operation at this point by pressing the [-] button.

- 6 Press the [EXECUTE] button again, or the [+] button, and the delete operation will begin.**

CAUTION

- Once the delete-in-progress message appears on the display the operation cannot be canceled. Never turn off the power or remove the SmartMedia card during this operation.

- 7 A message will appear on the display to inform you that the operation has finished.**
Press the [EXIT] button to return to the MAIN display.

NOTE

- If the SmartMedia card has been write-protected, an appropriate message will appear on the display and you will not be able to execute the operation.
- If the SmartMedia card contains no data that can be deleted an appropriate message will appear on the display and you will not be able to execute the operation.

Playing Songs Saved To SmartMedia

- 1 Make sure that the SmartMedia card containing the song you want to play has been properly inserted into the instrument's card slot, and that the file control icon is showing in the MAIN display. If the icon is not showing change the Media Select setting to SmartMedia.**
- 2 Press the [SONG] button.**
- 3 Use the dial to select the song you want to play (036 -).**
- 4 Press the [START/STOP] button.**

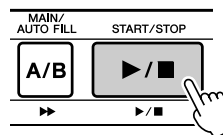

Save Your Easy Song Arranger Settings To SmartMedia

Your Easy Song Arranger settings for songs that have been saved to SmartMedia can also be saved to the SmartMedia card.

Press the [FILE CONTROL] button while holding the [EASY SONG ARRANGER] button to save the current Easy Song Arranger settings to the SmartMedia card.

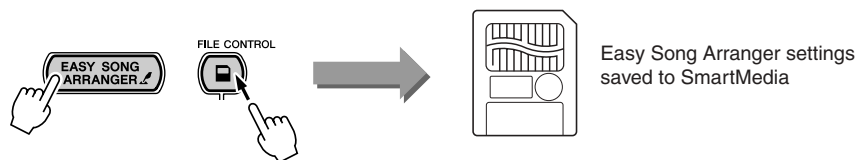

Connecting To a Computer

Nearly all of the electronic musical instruments made today – particularly synthesizers, sequencers and computer music related devices – use MIDI. MIDI is a worldwide standard that allows these devices to send and receive performance and setting data. Naturally, this instrument lets you save or send your keyboard performance as MIDI data, as well as that of the songs, styles and panel settings.

The potential MIDI holds for your live performance and music creation/production is enormous – simply by connecting this instrument to a computer and transmitting MIDI data. In this section, you'll learn the basics of MIDI and the particular MIDI functions of this instrument.

What Is MIDI?

No doubt you have heard the terms “acoustic instrument” and “digital instrument.” In the world today, these are the two main categories of instruments. Let's consider a grand piano and a classical guitar as representative acoustic instruments. They are easy to understand. With the piano, you strike a key, and a hammer inside hits some strings and plays a note. With the guitar, you directly pluck a string and the note sounds. But how does a digital instrument go about playing a note?

● Acoustic guitar note production

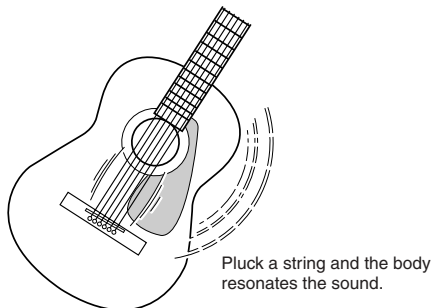

● Digital instrument note production

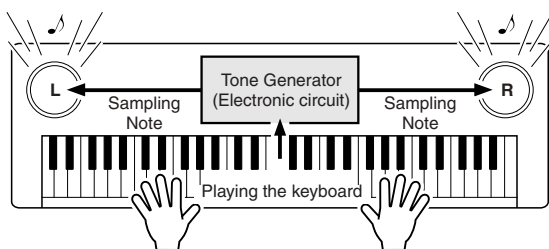

Based on playing information from the keyboard, a sampling note stored in the tone generator is played through the speakers.

As shown in the illustration above, in an electronic instrument the sampling note (previously recorded note) stored in the tone generator section (electronic circuit) is played based on information received from the keyboard. So then what is the information from the keyboard that becomes the basis for note production?

For example, let's say you play a “C” quarter note using the grand piano sound on the instrument. Unlike an acoustic instrument that puts out a resonated note, the electronic instrument puts out information from the keyboard such as “with what voice,” “with which key,” “about how strong,” “when was it pressed,” and “when was it released.” Then each piece of information is changed into a number value and sent to the tone gener-

ator. Using these numbers as a basis, the tone generator plays the stored sampling note.

Example of Keyboard Information

Voice number (with what voice)	1 (grand piano)
Note number (with which key)	60 (C3)
Note on (when was it pressed) and note off (when was it released)	Timing expressed numerically (quarter note)
Velocity (about how strong)	120 (strong)

Your keyboard performance and all panel operations of this instrument are processed as MIDI data. The songs, auto accompaniment (styles), and User songs are also made up of MIDI data.

MIDI is an acronym that stands for Musical Instrument Digital Interface and it allows different musical instruments and devices to instantly communicate with each other, via digital data. The MIDI standard is used all over the world and was designed to transmit performance data between electronic musical instruments (or computers). Thanks to MIDI, you can control one instrument from another and transmit performance data between the devices-taking your creative and performance potential to even higher levels.

MIDI messages can be divided into two groups: Channel messages and System messages.

● Channel Messages

This instrument is capable of handling 16 MIDI channels simultaneously – meaning it can play up to sixteen different instruments at the same time. Channel messages transmit information such as Note ON/OFF, Program Change, for each of the 16 channels.

Message Name	Instrument Operation/Panel Setting
Note ON/OFF	Performance data of the keyboard (contains note number and velocity data)
Program Change	Instrument selection (including bank select MSB/LSB, if necessary)
Control Change	Instrument settings (volume, pan, etc.)

● System Messages

This is data that is used in common by the entire MIDI system. System messages include messages like Exclusive Messages that transmit data unique to each instrument manufacturer and Realtime Messages that control the MIDI device.

Message Name	Instrument Operation/Panel Setting
Exclusive Message	Reverb/chorus settings, etc.
Realtime Messages	Start/stop operation

USB Connection

This instrument can be connected to a computer to allow transfer of MIDI data.

Connect a standard USB cable between the instrument's rear-panel USB connector and the USB connector on your computer (USB cable sold separately).

It is also necessary to install the USB driver provided on the supplied CD-ROM on your computer. Refer to the "Accessory CD-ROM Installation Guide" on page 84 for details.

The supplied CD-ROM also includes a Musicsoft Downloader application that allows you to transfer song files from your computer to the instrument's SmartMedia or flash memory.

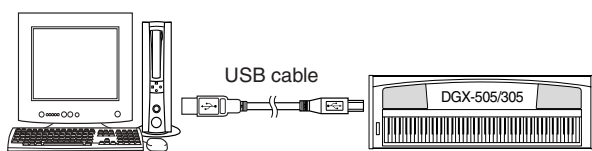

■ USB Precautions

Please observe the following precautions when connecting the instrument to a computer via a USB cable. Failure to do so can cause the instrument and/or the computer to hang up (freeze), possibly causing corruption or loss of data.

If the instrument or computer does hang up, turn the power to both devices off and then on again, and restart the computer.

⚠ CAUTION

- Wake the computer from a sleep/suspended/standby mode before connecting the USB cable.
- Connect the USB cable to the instrument and computer before turning power to the instrument on.
- Check the following points before turning the instrument's power on or off, and before plugging or unplugging the USB cable.
 - Quit all applications.
 - Make sure that no data transfer is in progress (data is transferred whenever you play on the keyboard or play a song).
- Allow at least 6 seconds between turning the instrument's power on and off, and between plugging and unplugging the USB cable.
- Directly connect the instrument to the computer using a single USB cable. Do not use a USB hub.

NOTE

- The Musicsoft Downloader application may not be able to access the instrument in the following cases:
 - When an unformatted SmartMedia card is inserted while the Media Select setting is "SmartMedia".
 - During a MIDI bulk dump.
 - While the opening display is showing.
 - During style playback.
 - During song playback.
 - During a file control operation (while the FILE CONTROL display is showing).
 - When the Media Select setting is "SmartMedia" but no SmartMedia card is inserted.

MIDI Settings

These settings pertain to MIDI data transmission and reception.

■ Local ON/OFF

Local control determines whether or not notes played on the instrument are sounded by its internal tone generator system: the internal tone generator is active when local control is on, and inactive when local control is off.

ON This is the normal setting in which notes played on the DGX-505/305 keyboard are sounded by the internal tone generator system. Data received via the instrument's USB connector will also be played by the internal tone generator.

OFF With this setting the instrument itself produces no sound (keyboard performance, harmony, or style playback), but the performance data is transmitted via the USB connector. Data received via the instrument's USB connector will also be played by the internal tone generator.

Local control can be turned on or off via the FUNCTION display Local item (page 72).

NOTE

- If you can't get any sound out of the instrument, this may be the most likely cause. Playing the keyboard results in no sound when Local is set to OFF.

■ External Clock ON/OFF

These settings determine whether the instrument is synchronized to its own internal clock (OFF), or to a clock signal from an external device (ON).

ON The instrument's time based functions will be synchronized to the clock from an external device connected to the USB connector.

OFF The instrument uses its own internal clock (default).

External clock control can be turned on or off via the FUNCTION display External Clock item (page 72).

NOTE

- If External Clock is ON and no clock signal is being received from an external device, the song, style, and metronome functions will not start.

MIDI (PC Mode) Settings For Computer Connection

A number of MIDI settings need to be made when you connect the instrument to a computer. The PC Mode item can conveniently make multiple settings for you in one operation. Three settings are available: PC1, PC2, and OFF. Press the [PC] button to call up the PC Mode display, and select PC1 or PC2, as required. The setting you choose will set parameters such as Local ON/OFF, External Clock ON/OFF, and others for optimum operation with a sequencer application on your computer, for example. Refer to page 72 for details about the MIDI settings.

NOTE

- Set the PC mode to PC2 when using Digital Music Notebook* in the supplied CD-ROM.
- * "Digital Music Notebook" is a software application for handling songs and scores on your computer. Refer to the application's online help file for more information.

	PC1	PC2	PC Mode = OFF
Local	OFF	OFF	ON
External Clock	ON	OFF	OFF
Keyboard Out	OFF	ON	ON
Style Out	OFF	OFF	ON
Song Out	OFF	OFF	ON

■ Setting the PC Mode

1 Press the [PC] button so that the FUNCTION display PC Mode item appears.

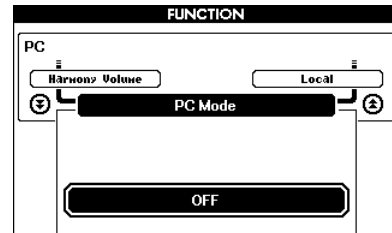
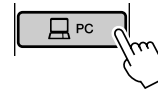

2 Use the dial or the [+] and [-] buttons to select PC1, PC2, or OFF.

NOTE

- When the PC2 setting is selected the instrument's style, song, demo, song recording, and lesson features cannot be used.

NOTE

- You can also access the PC Mode item by first pressing the [FUNCTION] button and then using the CATEGORY [▲] and [▼] buttons to locate it (page 70).

Remote control of MIDI devices

You can also use this instrument as a remote control device for the Digital Music Notebook application on your computer (via the USB connection) — controlling playback, stop and transport functions from the panel.

■ Remote control keys

DGX-505: To use the remote control functions, simultaneously hold down the lowest two keys on the keyboard (A-1 and A#-1) and press the appropriate key (shown below).

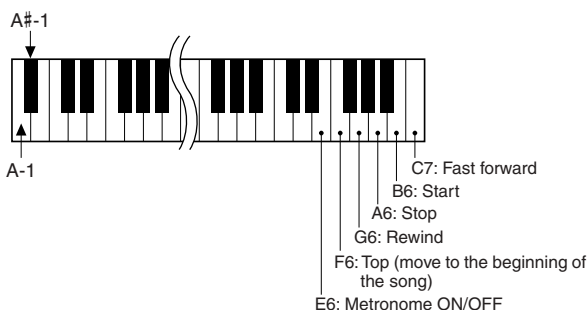

DGX-305: To use the remote control functions, simultaneously hold down the lowest two keys on the keyboard (E0 and F#0) and press the appropriate key (shown below).

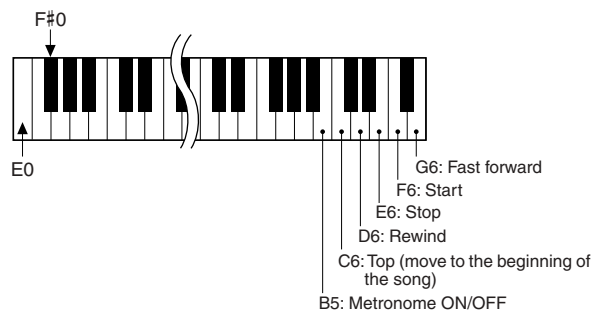

NOTE

- Remote control of MIDI devices will function independently of the PC2 mode.

Transferring Song Files From a Computer

This instrument can access two types of memory for storage and retrieval of song data: SmartMedia and flash memory. When song files are transferred to these memory media from your computer they can be used with the instrument's performance assistant technology or Lesson functions.

In order to transfer songs between your computer and the instrument you will need to install the Musicsoft Downloader application and the USB-MIDI Driver included on the Accessory CD-ROM on your computer. Refer to the Accessory CD-ROM Installation Guide on page 84 for installation details.

NOTE

- The following are required in order to transfer song files to the instrument's memory media:
 - USB cable.
 - SmartMedia (when transferring to SmartMedia memory).
- USB cables and SmartMedia cards can be purchased at an electrical goods or computer supply store.

Data That Can be Transferred From a Computer To This Instrument

- Song Capacity (max.) SmartMedia 894 songs (Song numbers 036 – 929)
Flash memory 512 songs (Song numbers 036 – 547)
- Data Capacity Flash memory 875 kb
- Data Format SMF format 0/1, SFF

With the Musicsoft Downloader You Can

- Transfer MIDI songs you have downloaded from the Internet or created on your computer from the computer to the instrument's SmartMedia or flash memory.

→ See page 82 for the procedure.

The procedure for transferring songs included on the Accessory CD-ROM from your computer to the instrument is given as an example.

Use the Musicsoft Downloader application with Internet Explorer 5.5 or higher.

Use Musicsoft Downloader To Transfer Songs From the Accessory CD-ROM To the Instrument's Smart-Media/flash memory

NOTE

- If a song or style is being played, stop playback before proceeding. Also, if the File Control display is showing press the [EXIT] button to return to the MAIN display.

- Before transferring to the instrument's SmartMedia memory** → Insert a SmartMedia card into the card slot, and make sure that Media Select (page 67) is set to SmartMedia.

 - Before transferring to the instrument's flash memory** → Make sure that Media Select is set to Flash Memory.
 - Install the Musicsoft Downloader application and the USB-MIDI driver on your computer (page 85 – 87).
 - Insert the supplied CD-ROM into your computer's CD-ROM drive. The start window should appear automatically, and close the window.
 - Double-click the Musicsoft Downloader shortcut icon that is created on the desktop. This will launch the Musicsoft Downloader application and the main window will appear.
- NOTE**
- The instrument cannot be operated while the Musicsoft Downloader is running.
- Click the "Add File" button and the Add File window will appear.
 - Click the [▼] button to the right of "Look in" and select the CD-ROM drive from the drop-down menu that appears. Double-click the "SongCollection" Folder on the window. Select the file you want to transfer to the instrument, and click "Open."

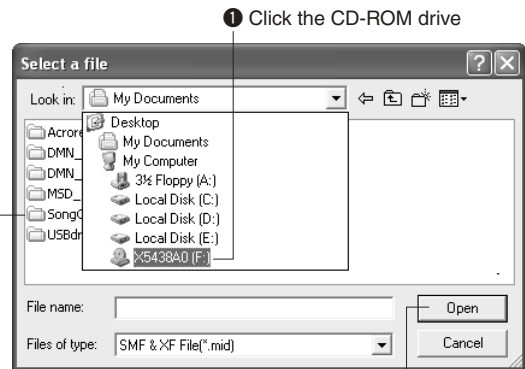

- Double-click "SongCollection" Folder. Double-click "for_CD" Folder and click a song file.
- Click "Open"

- 7** A copy of the selected MIDI song file will appear in the “List of files stored temporarily” at the top of the window. The currently selected memory medium will also be displayed at the bottom of the display to specify the destination for the transfer. Click the memory medium.

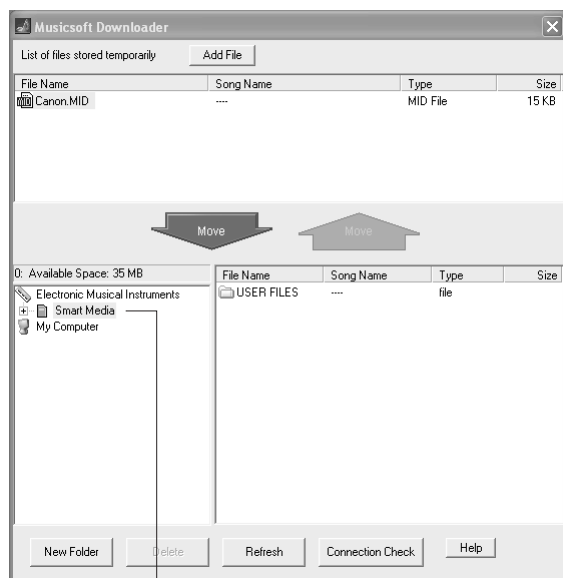

1 Click the memory medium

When transferring to the instrument’s SmartMedia memory, the USER FILES folder will appear in the lower right area of the window. This folder contains user data files (files with the “.USR” extension) saved using the instrument’s File Control function (page 75), and user songs (files with the “.MID” extension) saved using the SMF Convert function (page 76). The USER FILES folder is a storage area reserved for files used by the instrument’s File Control function.

- 8** After selecting the file in the “List of files stored temporarily”, click the downward [Move] button and a confirmation message will appear. Click [OK] and the song will be transferred from the “List of files stored temporarily” to the instrument’s memory. When transferring to the instrument’s SmartMedia memory, if you click the [Move] button while the window is as shown in step 7, the song file will be transferred to the SmartMedia root directory. The transferred song file can be played back on the instrument as song number 036 or higher.

NOTE

- Files transferred to a location other than the root directory in SmartMedia, the instrument’s flash memory, or other media using Musicsoft Downloader cannot be deleted from the instrument’s File Control display. Use the Musicsoft Downloader [Delete] button to delete these files.

- 9** Close the window to end the Musicsoft Downloader.

NOTE

- End the Musicsoft Downloader to playback the song transferred from your computer.

- 10** To playback a song stored in flash memory/SmartMedia, press the [SONG] button. Use the dial to select the song you want to play, then press the [START/STOP] button to start playback.

Style Files

Style files (files with the “.STY” extension) can be transferred to SmartMedia using the same procedure as described above. Style files transferred to the SmartMedia root directory can be loaded into style number 136 from the instrument’s File Control display and then played.

CAUTION

- Do not unplug the USB cable during a data transfer. Not only will the data not be transferred and saved, but operation of the memory media may become unstable and its contents may disappear completely when the power is turned on or off.

CAUTION

- Store data can be lost due to equipment malfunction or improper operation. For safety we recommend that you keep a copy of all important data stored on your computer.
- We recommend that you use a power adaptor rather than batteries when transferring data. The data can be corrupted if the batteries fail during the transfer.

To Use transferred Songs For Lessons or Score Display ...

In order to use songs (only SMF format 0) transferred from a computer for lessons it is necessary to specify which channels are to be played back as the right-hand and left-hand parts. The procedure for setting the “guide track” is as follows:

- Press the [SONG] button and select the song (036 –) residing in SmartMedia or flash memory for which you want to set the guide track.
- Press the [FUNCTION] button to call up the FUNCTION display.
- Use the CATEGORY [▲] and [▼] buttons to select the R-Part or L-Part item.
- Use the dial to select the channel you want to play back as the specified right- or left-hand part.

We recommend that you select channel 1 for the right-hand part and channel 2 for the left-hand part.

SPECIAL NOTICES

- The software and this Installation Guide are exclusive copyrights of Yamaha Corporation.
- Use of the software and this guide is governed by the SOFTWARE LICENSING AGREEMENT which the purchaser fully agrees to upon breaking the seal of the software packaging. (Please read carefully the AGREEMENT at the end of this guide before installing the application.)
- Copying of the software or reproduction of this guide in whole or in part by any means is expressly forbidden without the written consent of the manufacturer.
- Yamaha makes no representations or warranties with regard to the use of the software and documentation and cannot be held responsible for the results of the use of this guide and the software.
- This disc is a CD-ROM. Do not attempt to play the disc on an audio CD player. Doing so may result in irreparable damage to your audio CD player.
- Copying of the commercially available music data is strictly prohibited except for your personal use.
- The company names and product names in this Installation Guide are the trademarks or registered trademarks of their respective companies.
- Future upgrades of application and system software and any changes in specifications and functions will be announced separately.
- Software such as the USB MIDI driver may be revised and updated without prior notice. Make sure to check and download the latest version of the software from the following site.
<http://music.yamaha.com/download/>
- Depending on the version of your operating system, the screen shots and messages shown in this guide may differ to those that you see on your computer screen.

CD-ROM Contents

The data on this CD-ROM is compatible with computers running the Windows® operating system.

⚠ CAUTION

- Do not attempt to play this CD-ROM on an audio CD player. The result high-volume noise can potentially cause hearing damage or damage your CD player and speakers.

Folder Name	Application/Data Name	Contents
MSD_	Musicsoft Downloader *1 *2	This application can be used to download MIDI song data from the Internet and transfer it from the computer to memory media supported by the instrument (SmartMedia or flash memory).
DMN_	Digital Music Notebook *2	Digital Music Notebook is a major new multimedia platform for music tuition and performance.
USBdrv_	USB Driver For Windows 98/Me	This driver software is necessary to connect MIDI devices to your computer via USB.
USBdrv2k_	USB Driver For Windows 2000/XP	
Acroread_	Acrobat Reader 5.1 *2 *3	This application allows you to read pdf-format software manuals on your computer.
SongCollection	MIDI Songs (70 songs)	These songs can be transferred to the instrument for listening, score display, and/or lessons.
	Song Book (pdf file)	A pdf file contains the scores for the instrument's internal songs as well as the 70 MIDI songs included on the CD-ROM (not including copyrighted songs).

- * 1 The software cannot be used when the instrument is in the following state:
- No SmartMedia card has been inserted even when the FUNCTION display Media Select item is set to SmartMedia.
 - During style or song playback.
 - During a lesson.
 - While data is being loaded from a SmartMedia card.

- While the opening display is showing (the opening display is the display that appears for a few seconds when the instrument's power is turned on).
- * 2 This software includes an online manual.
- * 3 This software is not supported by Yamaha Corporation.

■ Using the CD-ROM ●●●●●●●●●●

Please read the Software License Agreement on page 88 before opening the CD-ROM package.

- 1 Check the system requirements to make sure that the software will run on your computer.**
- 2 Insert the Accessory CD-ROM into your computer's CD-ROM drive. The start window should appear automatically.**

3 Connect the instrument to the computer. The connection procedure is described on page 80.

4 Install the driver on your computer and make the necessary settings.
Refer to "Installing the USB-MIDI Driver" on page 85 for installation and setup instructions.

5 Install the software.

- **Digital Music Notebook and Musicsoft Downloader:**
Refer to page 87.
- **Acrobat reader and YAMAHA USB-MIDI Driver:**
Refer to page 85.

6 Launch the software.

For further software operation refer to the online help supplied with the software.

System Requirements

Application/Data	OS	CPU	Memory	Hard Disk	Display
Musicsoft Downloader	Windows 98SE/Me/2000/XP Home Edition/XP Professional	233 MHz or higher; Intel® Pentium®/Celeron® processor family	64 MB or more (256 MB or more is recommended)	at least 128 MB of free space (at least 512 MB of free space is recommended)	800 x 600 HighColor (16bit)
USB Driver for Windows 98/Me	Windows 98/98SE/Me	166 MHz or higher; Intel® Pentium®/Celeron® processor family	32 MB or more (64 MB or more is recommended)	at least 2 MB of free space	—
USB Driver for Windows 2000/XP	Windows 2000/XP Home Edition/XP Professional				
Digital Music Notebook	Windows® XP Professional Edition, SP1a more Windows® XP Home Edition, SP1a more	300MHz or higher; Intel® Pentium®/Celeron® Processor family (1GHz or more is recommended)	128 MB or more (256 MB or more is recommended)	at least 50 MB of free space	1024 x 768 HighColor (16bit)
Digital Music Notebook (Requirements for playing content with video included.)	Windows 2000 Professional, SP4 more	1GHz or higher; Intel® Pentium®/Celeron® Processor family (1.4GHz or more is recommended)	256 MB or more		

Software Installation

● Uninstall (Removing the Software)

Installed software can be removed from your computer as follows:
From the Windows Start menu select Start → Settings → Control panel → Add or Remove Applications → Install and Uninstall. Select the item you want to remove and click [Add or Remove]. Follow the on-screen instructions to remove the selected software.

NOTE

• The actual names of the menu items and buttons will depend on the OS version you are using.

■ Installing Acrobat Reader

This application is required to read the pdf manuals supplied with the software applications.

NOTE

• If a previous version of Acrobat Reader is already installed on your computer, be sure to uninstall the earlier version before installing the new version.

- 1 Click the [Acrobat Reader] button.**
Four different language buttons will appear.
- 2 Click the [INSTALL] button for your language.**
- 3 Follow the on-screen instructions to install the software.**

After installation the Acrobat folder will appear in your computer's Program Files (default) folder. Refer to Reader help in the Help menu for operating instructions.

■ Installing the USB-MIDI Driver

In order to be able to communicate with and use MIDI devices connected to your computer, the appropriate driver software must be properly installed on your computer.
The USB-MIDI driver allows sequence software and similar applications on your computer to transmit and receive MIDI data to and from MIDI devices via a USB cable.

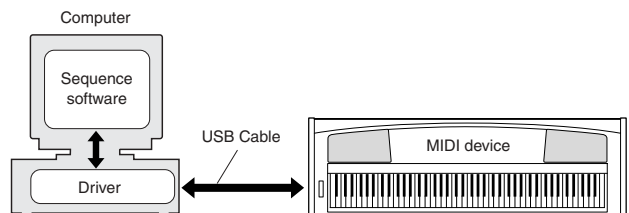

- **Windows 98/Me installation → page 86.**
- **Windows 2000 installation → page 86.**
- **Windows XP installation → page 87.**

Check the drive name of the CD-ROM drive you will be using (D:, E:, Q: etc.) The drive name is displayed beside the CD-ROM icon in your "My Computer" folder. The root directory of the CD-ROM drive will be D:\, E:\, or Q:\, respectively.

Installing the driver on Windows 98/Me

- 1** Start the computer.
- 2** Insert the supplied CD-ROM into the CD-ROM drive. A start window will appear automatically. Close the window.
- 3** First, make sure the POWER switch on the instrument is set to OFF, then use a USB cable to connect the USB terminal of the computer to the USB connector of the instrument. When the instrument is turned on, the computer automatically displays the “Add New Hardware Wizard.” If the Add New Hardware Wizard does not appear, click “Add New Hardware” in the Control Panel. For Windows Me users, check the radio button to the left of “Automatic search for a better driver (Recommended)” and click [Next]. The system automatically starts searching and installing the driver. Proceed to Step 8. If the system does not detect the driver, select “Specify the location of the driver (Advanced)” and specify the CD-ROM drive’s “USBdrv_” folder to install the driver and click [Next]. Execute the installation by following the onscreen instructions and proceed to Step 8.

NOTE

- If you are using Windows Me, skip Step 4 – 7.

- 4** Click [Next].
The window enables you to select the search method.
- 5** Check the radio button to the left of “Search for the best driver for your device. (Recommended).” Click [Next].
The window enables you to select a location in which to install the driver.
- 6** Check the “Specify a location” box, click “Browse..”, then specify the USBdrv directory of the CD-ROM drive (such as D:\USBdrv_) and continue the installation.
- 7** When the system detects the driver on the CD-ROM and is ready for installation, it is shown as a message on the screen. Make sure that the “YAMAHA USB MIDI Driver” is listed, and click [Next]. The system starts the installation.
- 8** When installation is complete, a message indicating so appears. Click [Finish].

NOTE

- Some computers may take about ten seconds to show this screen after the installation is complete.

The driver has been installed.

Installing the driver on Windows 2000

- 1** Start the computer and use the “Administrator” account to log into Windows 2000.
- 2** Select [My Computer] → [Control Panel] → [System] → [Hardware] → [Driver Signing] → [File Signature Verification], and check the radio button to the left of “Ignore — Install all files, regardless of file signature” and click [OK].
- 3** Insert the supplied CD-ROM into the CD-ROM drive. A start window will appear automatically. Close the window.
- 4** First, make sure the POWER switch on the instrument is set to OFF, then use a USB cable to connect the USB connector of the computer to the USB connector of the instrument. When the instrument is turned on, the computer automatically displays the “Found New Hardware Wizard.” Click [Next].
- 5** Check the radio button to the left of “Search for a suitable driver for my device. (Recommended).” Click [Next].
The window that appears enables you to select a location in which to install the driver.
- 6** Check the “CD-ROM drives” box and uncheck all other items. Click [Next].

NOTE

- The system may ask you to insert a Windows CD-ROM while it checks for the driver. Specify the “USBdrv2k_” directory of the CD-ROM drive (such as D:\USBdrv2k_) and continue the installation.

- 7** When the installation is complete, the system displays “Completing the Found New Hardware Wizard.” Click [Finish].

NOTE

- Some computers may take about ten seconds to show this screen after the installation is complete.

- 8** Restart the computer.

The driver has been installed.

Installing the driver on Windows XP

- 1** Start the computer.
 - 2** Select [Start] → [Control Panel]. If the control panel appears as “Pick a category”, click “Switch to Classic View” in the upper left of the window. All control panels and icons will be displayed.
 - 3** Go to [System] → [Hardware] → [Driver Signing Options] and check the radio button to the left of “Ignore” and click [OK].
 - 4** Click the [OK] button to close System Properties, and then click “X” in the upper right of the window to close the Control Panel.
 - 5** Insert the supplied CD-ROM into the CD-ROM drive. A start window will appear automatically. Close the window.
 - 6** First, make sure the POWER switch on the instrument is set to OFF, then use a USB cable to connect the USB connector of the computer to the USB connector of the instrument. When the instrument is turned on, the computer automatically displays the “Found New Hardware Wizard.”
- NOTE**
- Some computers may take a few minutes to show this screen.
- 7** Check the radio button to the left of “Install the software automatically. (Recommended).” Click [Next]. The system starts the installation.
 - 8** When the installation is complete, the system displays “Completing the Found New Hardware Wizard.” Click [Finish].
- NOTE**
- Some computers may take about a few minutes to show this screen after the installation is complete.
- 9** Restart the computer. The driver has been installed.

The driver has been installed.

■ Installing the Musicsoft Downloader and Digital Music Notebook Applications

IMPORTANT

- You will need to log in with administrator (root) privileges in order to install Musicsoft Downloader on a computer running Windows 2000 or XP.
- You will need to log in with administrator (root) privileges in order to install Digital Music Notebook on a computer running Windows 2000 or XP.

IMPORTANT

- When installing the Digital Music Notebook, make sure that Internet Explorer 6.0 (with SP1) or higher is installed to your computer.

IMPORTANT

- Credit card settlement is required to purchase Digital Music Notebook content. Credit card processing may not be possible for some areas, so please check with your local authorities to make sure that your credit card can be used.

- 1** Insert the Accessory CD-ROM into your computer’s CD-ROM drive. The start window will appear automatically showing software applications.

NOTE

- If the start window does not appear automatically, double click your “My Computer” folder to open it. Right-click the CD-ROM icon and select “Open” from the pop-up menu. Double click “Start.exe” and proceed to step 2, below.

- 2** Click [Musicsoft Downloader] or [Digital Music Notebook].
- 3** Click [install] button, and follow the on-screen instructions to install the software. For Digital Music Notebook operating instructions see the help menu: launch the Digital Music Notebook application and click “Help”.

For Musicsoft Downloader operating instructions see the Help menu: launch the Musicsoft Downloader application and click “Help”.

- * You can obtain the latest version of the Musicsoft Downloader at the following Internet URL.

<http://music.yamaha.com/download/>

IMPORTANT

- Only Musicsoft Downloader can be used to transfer files between this instrument and a computer. No other file transfer application can be used.

SOFTWARE LICENSING AGREEMENT

The following is a legal agreement between you, the end user, and Yamaha Corporation (“Yamaha”). The enclosed Yamaha software program is licensed by Yamaha to the original purchaser for use only on the terms set forth herein. Please read this licensing agreement with care. Opening this package indicates that you accept all terms outlined herein. If you do not agree to the terms, return this package unopened to Yamaha for a full refund. In the event that you obtained the enclosed Yamaha software program(s) as a part of a software package or software bundled with a hardware product, you may not return the enclosed Yamaha software program(s) to Yamaha.

1. GRANT OF LICENSE AND COPYRIGHT

Yamaha grants you, the original purchaser, the right to use one copy of the enclosed software program and data (“SOFTWARE”) on a single-user computer system. You may not use it on more than one computer or computer terminal. The SOFTWARE is owned by Yamaha and is protected by Japanese copyright laws and all applicable international treaty provisions. You are entitled to claim ownership of the media in which the SOFTWARE is included. Therefore, you must treat the SOFTWARE like any other copyrighted materials.

2. RESTRICTIONS

The SOFTWARE program is copyrighted. You may not engage in reverse engineering or reproduction of the SOFTWARE by other conceivable methods. You may not reproduce, modify, change, rent, lease, resell, or distribute the SOFTWARE in whole or in part, or create derivative works from the SOFTWARE. You may not transmit or network the SOFTWARE with other computers. You may transfer ownership of the SOFTWARE and the accompanying written materials on a permanent basis provided that you retain no copies and the recipient agrees to the terms of the licensing agreement.

3. TERMINATION

The licensing condition of the software program becomes effective on the day that you receive the SOFTWARE. If any one of the copyright laws or clauses of the licensing conditions is violated, the licensing agreement shall be terminated automatically without notice from Yamaha. In this case, you must destroy the licensed SOFTWARE and its copies immediately.

4. PRODUCT WARRANTY

Yamaha warrants to the original purchaser that if the SOFTWARE, when used in normal conditions, will not perform the functions described in the manual provided by Yamaha, the sole remedy will be that Yamaha will replace any media which proves defective in materials or workmanship on an exchange basis without charge. Except as expressly set forth above, the SOFTWARE is provided “as is,” and no other warranties, either expressed or implied, are made with respect to this software, including, without limitation the implied warranties of merchantability and fitness for a particular purpose.

5. LIMITED LIABILITY

Your sole remedies and Yamaha’s entire liability are as set forth above. In no event will Yamaha be liable to you or any other person for any damages, including without limitation any incidental or consequential damages, expenses, lost profits, lost savings or other damages arising out of the use or inability to use such SOFTWARE even if Yamaha or an authorized dealer has been advised of the possibility of such damages, or for any claim by any other party.

6. GENERAL

This license agreement shall be interpreted according to and governed by Japanese laws.



Troubleshooting

■ For the DGX-505/305

Problem	Possible Cause and Solution
When the instrument is turned on or off, a popping sound is temporarily produced.	This is normal and indicates that the instrument is receiving electrical power.
When using a mobile phone, noise is produced.	Using a mobile phone in close proximity to the instrument may produce interference. To prevent this, turn off the mobile phone or use it further away from the instrument.
There is no sound even when the keyboard is played or when a song or style is being played back.	Check that nothing is connected to the PHONES/OUTPUT jack on the rear panel. When a set of headphones is plugged into this jack, no sound is output.
	Check the Local Control on/off. (See page 80.)
Playing keys in the right hand area of the keyboard does not produce any sound.	Is the FILE CONTROL display showing? The instrument’s keyboard, etc., will not produce any sound while the FILE CONTROL display is showing. Press the [EXIT] button to return to the MAIN display.
	When using the Dictionary function (page 63), the keys in the right hand area are used only for entering the chord root and type.
<ul style="list-style-type: none"> The volume is too soft. The sound quality is poor. The rhythm stops unexpectedly or will not play. The recorded data of the song, etc. does not play correctly. The LCD display suddenly goes dark, and all panel settings are reset. 	The batteries are low or dead. Replace all six batteries with completely new ones, or use the included AC adaptor.

Problem	Possible Cause and Solution
The style or song does not play back when the [START/STOP] button is pressed.	Is External Clock set to ON? Make sure External Clock is set to OFF; refer to "External Clock" on page 80.
The style does not sound properly.	Make sure that the Style Volume (page 71) is set to an appropriate level.
	Is the split point set at an appropriate key for the cords you are playing? Set the split point at an appropriate key (page 59). Is the "ACMP" indicator showing in the display? If it is not showing press the [ACMP ON/OFF] button so that it does show.
No rhythm accompaniment plays when the [START/STOP] button is pressed after selecting style number 112 or a style between 124 and 135 (Pianist).	This is not a malfunction. Style number 112 and style numbers 124 – 135 (Pianist) have no rhythm parts, so no rhythm will play. The other parts will begin playing when you play a chord in the accompaniment range of the keyboard if style playback is turned on.
Not all of the voices seem to sound, or the sound seems to be cut off.	The instrument is polyphonic up to a maximum of 32 notes. If the Dual voice or Split voice is being used and a style or song is playing back at the same time, some notes/sounds may be omitted (or "stolen") from the accompaniment or song.
The footswitch (for sustain) seems to produce the opposite effect. For example, pressing the footswitch cuts off the sound and releasing it sustains the sounds.	The polarity of the footswitch is reversed. Make sure that the footswitch plug is properly connected to the SUSTAIN jack before turning on the power.
The sound of the voice changes from note to note.	This is normal. The AWM tone generation method uses multiple recordings (samples) of an instrument across the range of the keyboard; thus, the actual sound of the voice may be slightly different from note to note.
The Demo display is shown in Japanese, and/or there are Japanese characters in the display messages.	Make sure the Language setting in the FUNCTION display is set to English. (See page 22)
The FILE CONTROL display can't be selected, even though a SmartMedia card is inserted in the card slot.	The FUNCTION display Media Select item might be set to Flash Memory. Media Select must be set to SmartMedia in order to use SmartMedia memory.
The appropriate display does not appear when the [SONG], [EASY SONG ARRANGER], [STYLE], or [VOICE] button is pressed.	Is another display showing? Try pressing the [EXIT] button to return to the MAIN display, and then pressing one of the mentioned buttons.
The wrong notes sound when the keyboard is played.	Perhaps the performance assistant technology is turned on. Press the [PERFORMANCE ASSISTANT] button to turn it off.
The ACMP indicator does not appear when the [ACMP ON/OFF] button is pressed.	Is the [STYLE] button lit? Always press the [STYLE] button first when you are going to use any style-related function.
The song number (036 –) of an external song file transferred to SmartMedia memory from a computer does not appear.	Perhaps Media Select is set to Flash Memory. Make sure that Media Select is set to SmartMedia (page 67).
The song number (036 –) of an external song file transferred to flash memory from a computer does not appear.	Perhaps Media Select is set to SmartMedia. Make sure that Media Select is set to Flash Memory (page 67).
There is no harmony sound.	The harmony effects (01 – 26) behave differently according to their type. Types 01 – 05 function when style playback is on, chords are played in the accompaniment range of the keyboard, and a melody is played in the right-hand range. Types 06 – 26 will function whether style playback is on or off. For types 06 = 12 you need to play two notes at the same time.

■ For the included software

The driver cannot be installed.

- **Is the USB cable connected correctly?**
Check the USB cable connection. Disconnect the USB cable, then connect it again.
- **Is the USB function enabled on your computer?**
When you connect the instrument to the computer for the first time, if the “Add New Hardware Wizard” does not appear, the USB function on the computer may be disabled. Perform the following steps.
 - 1** Select [Control Panel] → [System] → [Device Manager] (for Windows 98/Me), or select [Control Panel]* → [System] → [Hardware] → [Device Manager] (for Windows 2000/XP).
* Classic View only in Windows XP.
 - 2** Make sure that no “!” or “x” marks appear at “Universal serial bus controller” or “USB Root Hub.” If you see an “!” or “x” mark, the USB controller is disabled.
- **Is any unknown device registered?**
If driver installation fails, the instrument will be marked as an “Unknown device,” and you will not be able to install the driver. Delete the “Unknown device” by following the steps below.
 - 1** Select [Control Panel] → [System] → [Device Manager] (for Windows 98/Me), or select [Control Panel]* → [System] → [Hardware] → [Device Manager] (for Windows 2000/XP).
* Classic View only in Windows XP.
 - 2** Look for “Other devices” in the menu “View devices by type.”
 - 3** If you find “Other devices,” double-click it to extend the tree to look for “Unknown device.” If one appears, select it and click the [Remove] button.
 - 4** Remove the USB cable from the instrument, and make the connection again.
 - 5** Install the driver again.
 - Windows 98/Me users see page 86
 - Windows 2000 users see page 86
 - Windows XP users see page 87

When controlling the instrument from your computer via USB, the instrument does not operate correctly or no sound is heard.

- Did you install the driver? (page 85)
- Is the USB cable connected correctly?
- Are the volume settings of the instrument, playback device, and application program set to the appropriate levels?
- Have you selected an appropriate port in the sequence software?

- Are you using the latest USB MIDI driver? The latest driver can be downloaded from the following web site.
<http://music.yamaha.com/download/>

Playback response is delayed.

- Does your computer satisfy the system requirements?
- Is any other application or device driver running?

Cannot suspend or resume the computer correctly.

- Do not suspend the computer while the MIDI application is running.
If you are using Windows 2000, you may not be able to suspend/resume normally, depending on the particular environment (USB Host Controller, etc.). Even so, simply disconnecting and connecting the USB cable will allow you to use the instrument functions again.

How can I delete or re-install the driver?

Windows Me/98

- 1** When the instrument is recognized correctly, double-click “System” in the Control Panel to open the System window.
- 2** Double-click the “Device Manager” tab, select “YAMAHA USB MIDI Driver” and delete it.
- 3** Use the MS-DOS prompt or Explorer to delete the following three files.

NOTE

- To delete these files using Explorer, select “Folder Options” from the Tool (View) menu, and select “Show all files (and folders).”
 - \WINDOWS\INF\OTHER***.INF
 - \WINDOWS\SYSTEM\Xgusb.dr
 - \WINDOWS\SYSTEM\Ymidusb.sys

- 4** Disconnect the USB cable.
- 5** Restart the computer.
- 6** Re-install the driver.



Messages

LCD Message	Comment
Access error!	Indicates the failure in reading or writing from/to the SmartMedia or the flash memory.
All Memory Clearing...	Displayed while erasing all data in the flash memory. Never turn the power off during data transmission.
Are you sure?	Confirms whether Song Clear or Track Clear is executed or not.
Backup Clearing...	Displayed while clearing the back-up data in the flash memory.
Cancel	Displayed when the transmission of Initial or Bulk-Send is cancelled.
Clearing...	Displayed while executing Song Clear or Track Clear of the user songs.
Com Mode	Displayed when the Musicsoft Downloader is started on the PC connected to the keyboard. This will not be displayed while the instrument is played back.
Completed	Indicates the specified job completion such as data saving and transmission.
Create Directory	Displayed while creating a folder in the Musicsoft Downloader application.
Data Error!	Displayed when the user song contains illegal data.
Delete File	Displayed while deleting a song file in the Musicsoft Downloader.
Delete OK ?	Confirms whether the Delete job is executed or not.
Delete Directory	Displayed while deleting a folder in the Musicsoft Downloader.
Deleting...	Displayed while the delete function is engaged.
End	Displayed when the transmission of Initial or Bulk-Send has been completed.
Error!	Displayed when writing has failed.
"File information area is not large enough."	Indicates that saving data in the SmartMedia cannot be executed since the total number of files have become too many.
File is not found.	Indicates there is no file.
"File too large. Loading is impossible."	Indicates that loading data cannot be executed since the file data is too large.
Flash Clearing...	Displayed while clearing the song data transmitted to the internal flash memory.
Format OK ?	Confirms whether formatting the SmartMedia is executed or not.
Formatting...	Displayed while formatting.
Load OK ?	Confirms whether loading is executed or not.
Loading...	Displayed while loading data.
Media is not inserted.	Displayed when accessing the SmartMedia while it is not inserted.
Media capacity is full.	Displayed when saving data cannot be executed since the SmartMedia memory becomes full.
Memory Full	Displayed when the internal memory becomes full during song recording.
"MIDI receive buffer overflow."	Displayed when too much MIDI data was received at one time and failed to proceed.
Move File	Displayed while moving a file in the Musicsoft Downloader.
"Now Writing... (Don't turn off the power now, otherwise the data may be damaged.)"	Displayed while writing data in the memory. Never turn the power off while writing. Doing so may result in data loss.
Overwrite ?	Confirms whether overwriting is executed or not.
Please Wait...	Displayed when executing the jobs that take some time, such as displaying scores and lyrics.
Receive error!	Displayed when an error occurs during receiving bulk data.
Receiving...	Displayed while receiving bulk data.
Rename File	Displayed while rewriting the song file name in the Musicsoft Downloader.
Save OK ?	Confirms whether saving is executed or not.
Saved data is not found.	Displayed when the data to be saved doesn't exist.
"Saves the selected melody and style. (Don't turn off the power now, otherwise the data may be damaged.)"	Indicates to save the selected melody voice and style. Never turn the power off while saving. Doing so may result in data loss.

Messages

LCD Message	Comment
Saving...	Displayed while saving data in the memory. Never turn the power off while saving. Doing so may result in data loss.
Send OK?	Confirms whether the data transmission is executed or not.
Sending...	Displayed while transmitting data.
“Since the media is in use now, this function is not available.”	Indicates that the file control function is currently unavailable since the SmartMedia is being accessed.
Sure ?	Reconfirms whether each operation is executed or not.
“The limit of the media has been reached.”	Indicates that saving data cannot be executed since the folder/directory structure has become too complicated.
The media is not formatted.	Indicates the inserted SmartMedia has not been formatted.
“The media is write-protected.”	Indicates that the inserted SmartMedia cannot be written since it is write-protected. Remove the write-protect seal before use.
“The song data is too large to be converted to notation.”	Indicates that the score cannot be displayed since the song data is too large.
There are too many files.	Indicates that saving data cannot be executed since the total number of files exceeds the capacity.
“This function is not available now.”	Indicates the designated function is not available since the instrument is executing another job.
[nnn] “file name”	Indicates the file name of the currently transmitting song. “nnn” indicates the receiving block.

NOTE

- Not all the messages are listed in the table: the messages necessary to be explained only.



Keyboard Stand Assembly (DGX-505 Only)

⚠ CAUTION

Read these cautions carefully before you assemble or use the keyboard stand. These cautions are to promote safe use of the stand and to prevent injury and damage from occurring to you and others. By following these cautions carefully, your keyboard stand will provide you with safe and prolonged use.

- Be careful not to confuse parts, and be sure to install all parts in the correct direction. Please assemble in accordance with the sequence given below.
- Assembly should be carried out by at least two persons.
- Be sure to use the correct screw size, as indicated above. Use of incorrect screws can cause damage.
- Use the stand after assembly is complete. An uncompleted stand may overturn or the keyboard may drop.
- Always place the stand on a flat, stable surface. Placing the stand on uneven surfaces may cause it to become unstable or overturn, the keyboard to drop, or injury.
- Do not use the stand for anything other than its designed purpose. Placing other objects on the stand may result in the object dropping or the stand overturning.
- Do not apply excessive force to the keyboard as it may cause the stand to overturn or the keyboard to drop.
- Make sure the stand is sturdy and safe, and all screws have been tight and firm before use. If not, the stand may overturn, the keyboard may drop, or may result in injury to the user.
- To disassemble, reverse the assembly sequence given below.

Have a phillips-head (+) screwdriver ready.

The parts shown in the “Assembly Parts” illustration will be used. Follow the assembly instructions and select the parts as needed.

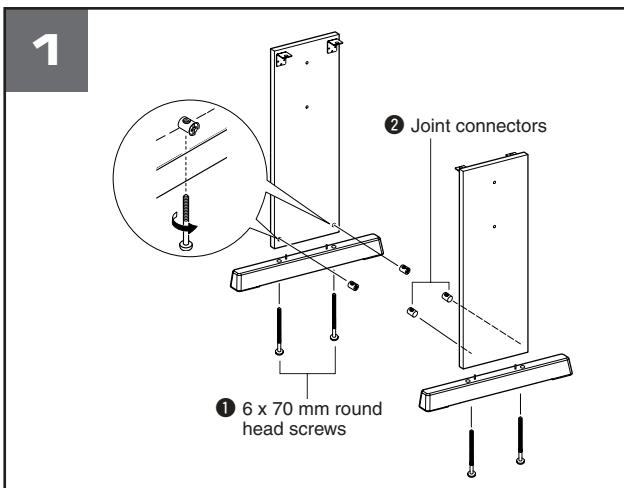
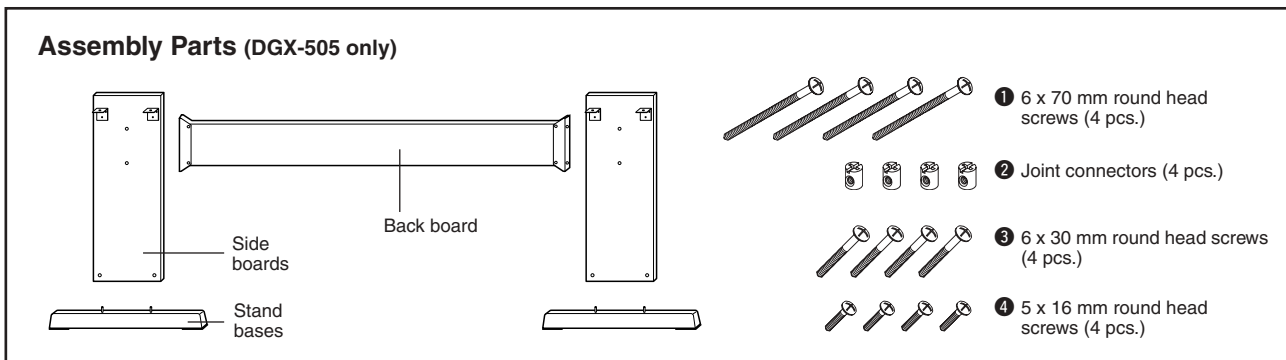

1 Attach the stand bases.

Making sure that the boards are facing the proper direction (the holes should face inside). The left and right side boards are the same shape. Insert the joint connectors ② into the holes as shown. The joint connectors have been installed properly if you can see a plus mark on the connector.

Attach the stand bases to the rear of the side boards, using the 6 x 70 mm round head screws ①. The left and right stand bases are the same shape, and there is no difference between their front-to-back orientation. If you have trouble screwing in the screws, use a screwdriver to rotate the joint connectors to the appropriate position – the → mark on the joint connectors indicates the location of the screw hole.

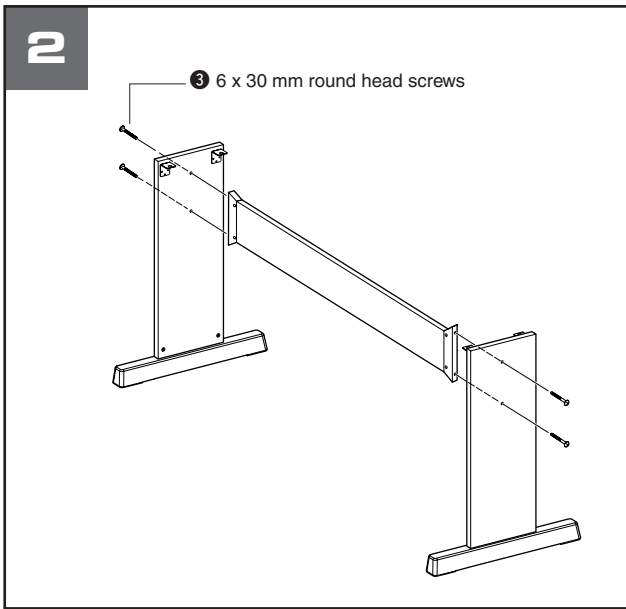

2 Attach the back board.

Attach the back board, using the 6 x 30 mm round head screws **3**.

There is no particular vertical or left-to-right orientation for the back board, and it can be installed either way.

CAUTION

- Be careful not to drop the back board or touch the sharp metal fittings.



3 Put the keyboard on the stand.

Carefully place the keyboard on the side boards.

There is no back-to-front orientation for the stand, and the keyboard can be placed on it facing either direction. Slowly move the keyboard so that the holes on the bottom of the keyboard are properly aligned with the holes on the angle brackets.

CAUTION

- Be careful not to drop the keyboard or to get your fingers caught between the keyboard and the stand parts.

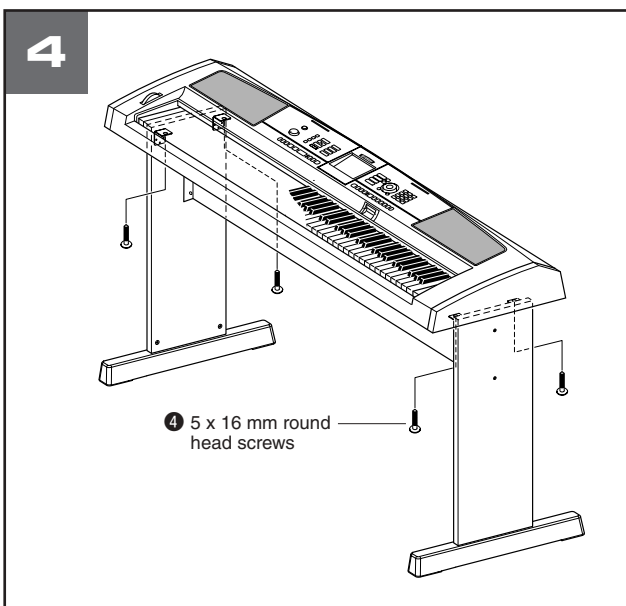

4 Install the keyboard to the stand.

Fix the keyboard to the angle brackets, using the 5 x 16 mm round head screws **4**.

■ Post-assembly checklist

Once you've assembled the stand, check the following points:

- Are there any parts left over?
 - If so, read the assembly instructions again and correct any errors you might have made.
- Is the instrument clear of doors and other movable fixtures?
 - If not, move the instrument to an appropriate location.
- Does the instrument make a rattling noise when you play it or move it?
 - If so, properly tighten all screws.
- Also, if the keyboard makes a creaking noise or seems unsteady when you play it, refer carefully to the assembly instructions and diagrams and retighten all screws.



Specifications

Keyboards

- DGX-505: 88-key light-weighted box type (A-1 – C7), with Touch Response.
- DGX-305: 76-key box type (E0 – G6), with Touch Response.

Display

- 320 x 240 dots backlit graphic LCD

Setup

- STANDBY/ON
- MASTER VOLUME: MIN - MAX
- LCD CONTRAST Control

Panel Controls

- SONG, VOICE, STYLE, EASY SONG ARRANGER, FILE CONTROL, EXECUTE, PERFORMANCE ASSISTANT, PC, LESSON L/R, LESSON MODE, LESSON REPEAT & LEARN, METRONOME, PORTABLE GRAND, LYRICS, SCORE, EXIT, DEMO, FUNCTION, TOUCH, HARMONY, DUAL, SPLIT, TEMPO/TAP, [0] – [9], [+], [-], CATEGORY, Dial, ACMP ON/OFF, SYNC STOP, SYNC START, START/STOP, INTRO/ENDING/rit., MAIN/AUTO FILL, REGIST. MEMORY (●) (MEMORY/BANK), [1], [2]), SONG MEMORY (REC, [1] – [5], [A])

Realtime Control

- Pitch Bend Wheel

Voice

- 121 panel voices + 12 drum kits + 359 XGlite voices + 2 XGlite optional voices
- Polyphony: 32
- DUAL
- SPLIT

Style

- 135 Preset Styles + 1 User Style file
- Style Control: ACMP ON/OFF, SYNC STOP, SYNC START, START/STOP, INTRO/ENDING/rit., MAIN/AUTO FILL
- Fingering: Multi fingering
- Style Volume

Card Slot

- 3.3V SmartMedia™

Education Feature

- Dictionary
- Lesson 1-3, Lesson Repeat & Learn

Registration Memory

- 8 banks x 2 types

Function

- VOLUME: Style Volume, Song Volume
- OVERALL: Tuning, Transpose, Split Point, Touch Sensitivity, Pitch Bend Range
- MAIN VOICE: Volume, Octave, Pan, Reverb Send Level, Chorus Send Level
- DUAL VOICE: Volume, Octave, Pan, Reverb Send Level, Chorus Send Level
- SPLIT VOICE: Volume, Octave, Pan, Reverb Send Level, Chorus Send Level
- EFFECT: Reverb Type, Chorus Type, Panel Sustain
- HARMONY: Harmony Type, Harmony Volume
- PC: PC1/PC2/Off
- MIDI: Local On/Off, External Clock, Initial Setup Send, Keyboard Out, Style Out, Song Out, Bulk Send
- METRONOME: Time Signature, Metronome Volume
- SCORE: Quantize
- LESSON: Lesson Track (R), Lesson Track (L), Grade
- UTILITY: Media Select, Demo Cancel
- LANGUAGE: Language Select (English/Japanese)

Effects

- Reverb: 9 types
- Chorus: 4 types
- Harmony: 26 types

Song

- 30 Preset Songs + 5 User Songs + Accessory CD-ROM Songs (70)
- Song Clear, Track Clear
- Song Volume

Performance assistant technology

- Chord Type/Melody Type

Recording

- Song
 - User Song: 5 Songs
 - Recording Tracks: 1, 2, 3, 4, 5, STYLE

MIDI

- Local On/Off
- Initial Setup Send
- External Clock
- Keyboard Out
- Style Out
- Song Out
- Bulk Send

Auxiliary jacks

- PHONES/OUTPUT, DC IN 12V, USB, SUSTAIN

Amplifier

- 6W + 6W

Speakers

- 12cm x 2 + 3cm x 2

Power Consumption (when using PA-5D power adaptor)

- 22W

Power Supply

- Adaptor: Yamaha PA-5D AC power adaptor
- Batteries: Six "D" size, R20P (LR20) or equivalent batteries

Dimensions (W x D x H)

- DGX-505: 1,376 x 431 x 173 mm (54-1/8" x 17" x 6-3/4")
- * with keyboard stand: 1,376 x 485 x 804 mm (54-1/8" x 19-1/8" x 31-2/3")
- DGX-305: 1,178 x 412 x 173 mm (46-3/8" x 16-1/4" x 6-3/4")

Weight

- DGX-505: 13.5kg (29 lbs. 12 oz.) (not including batteries)
- DGX-305: 9.2kg (20 lbs. 5 oz.) (not including batteries)
- Keyboard Stand (DGX-505 only): 7.5kg (16 lbs. 9 oz.)

Supplied Accessories

- Music Rest
- Accessory CD-ROM
- Owner's Manual
- Foot Switch (DGX-505 only)
- Keyboard Stand (DGX-505 only)

Optional Accessories

- AC Power Adaptor: PA-5D/PA-5C
- Footswitch: FC4/FC5
- Keyboard Stand: LW-15/LW-16 (DGX-305 only)

* The DGX-505 additionally comes supplied with an FC5 foot-switch and keyboard stand.

* Specifications and descriptions in this owner's manual are for information purposes only. Yamaha Corp. reserves the right to change or modify products or specifications at any time without prior notice. Since specifications, equipment or options may not be the same in every locale, please check with your Yamaha dealer.

Voice No.	Bank Select		MIDI Program Change# (1 - 128)	Voice Name
	MSB (0 - 127)	LSB (0 - 127)		
097	000	112	073	Piccolo
098	000	112	076	Pan Flute
099	000	112	075	Recorder
100	000	112	080	Ocarina
SYNTH LEAD				
101	000	112	081	Square Lead
102	000	112	082	Sawtooth Lead
103	000	112	086	Voice Lead
104	000	112	099	Star Dust
105	000	112	101	Brightness
106	000	115	082	Analogon
107	000	119	082	Fargo
SYNTH PAD				
108	000	118	089	SweetHeaven
109	000	112	089	Fantasia
110	000	113	101	Bell Pad
111	000	112	092	Xenon Pad
112	000	112	095	Equinox
113	000	113	090	Dark Moon
PERCUSSION				
114	000	112	012	Vibraphone
115	000	112	013	Marimba
116	000	112	014	Xylophone
117	000	112	0115	Steel Drums
118	000	112	009	Celesta
119	000	112	011	Music Box
120	000	112	015	Tubular Bells
121	000	112	048	Timpani
DRUM KITS (See page 100)				
122	127	000	001	Standard Kit 1
123	127	000	002	Standard Kit 2
124	127	000	009	Room Kit
125	127	000	017	Rock Kit
126	127	000	025	Electronic Kit
127	127	000	026	Analog Kit
128	127	000	028	Dance Kit
129	127	000	033	Jazz Kit
130	127	000	041	Brush Kit
131	127	000	049	Symphony Kit
132	126	000	001	SFX Kit 1
133	126	000	002	SFX Kit 2

● XGlite Voice/XGlite Optional Voice* List

Voice No.	Bank Select		MIDI Program Change# (1 - 128)	Voice Name
	MSB (0 - 127)	LSB (0 - 127)		
PIANO				
134	000	000	001	Grand Piano
135	000	001	001	Grand Piano KSP
136	000	040	001	Piano Strings
137	000	041	001	Dream
138	000	000	002	Bright Piano
139	000	001	002	Bright Piano KSP
140	000	000	003	Electric Grand Piano
141	000	001	003	Electric Grand Piano KSP
142	000	032	003	Detuned CP80
143	000	000	004	Honky-tonk Piano
144	000	001	004	Honky-tonk Piano KSP
145	000	000	005	Electric Piano 1
146	000	001	005	Electric Piano 1 KSP
147	000	032	005	Chorus Electric Piano 1
148	000	000	006	Electric Piano 2
149	000	001	006	Electric Piano 2 KSP
*150	000	032	006	Chorus Electric Piano 2
151	000	041	006	DX + Analog Electric Piano
152	000	000	007	Harpsichord
153	000	001	007	Harpsichord KSP
154	000	035	007	Harpsichord 3
155	000	000	008	Clavi
156	000	001	008	Clavi KSP

Voice No.	Bank Select		MIDI Program Change# (1 - 128)	Voice Name
	MSB (0 - 127)	LSB (0 - 127)		
CHROMATIC				
157	000	000	009	Celesta
158	000	000	010	Glockenspiel
159	000	000	011	Music Box
160	000	064	011	Orgel
161	000	000	012	Vibraphone
162	000	001	012	Vibraphone KSP
163	000	000	013	Marimba
164	000	001	013	Marimba KSP
165	000	064	013	Sine Marimba
166	000	097	013	Balimba
167	000	098	013	Log Drums
168	000	000	014	Xylophone
169	000	000	015	Tubular Bells
170	000	096	015	Church Bells
171	000	097	015	Carillon
172	000	000	016	Dulcimer
173	000	035	016	Dulcimer 2
174	000	096	016	Cimbalom
175	000	097	016	Santur
ORGAN				
176	000	000	017	DrawOrg
177	000	032	017	Detuned DrawOrg
178	000	033	017	60's DrawOrg 1
179	000	034	017	60's DrawOrg 2
180	000	035	017	70's DrawOrg 1
181	000	037	017	60's DrawOrg 3
182	000	040	017	16+2'2/3
183	000	064	017	Organ Bass
184	000	065	017	70's DrawOrg 2
185	000	066	017	Cheezy Organ
186	000	067	017	DrawOrg 3
187	000	000	018	Percussive Organ
188	000	024	018	70's Percussive Organ
189	000	032	018	Detuned Percussive Organ
190	000	033	018	Light Organ
191	000	037	018	Percussive Organ 2
192	000	000	019	Rock Organ
193	000	064	019	Rotary Organ
194	000	065	019	Slow Rotary
195	000	066	019	Fast Rotary
196	000	000	020	Church Organ
197	000	032	020	Church Organ 3
198	000	035	020	Church Organ 2
199	000	040	020	Notre Dame
200	000	064	020	Organ Flute
201	000	065	020	Tremolo Organ Flute
202	000	000	021	Reed Organ
203	000	040	021	Puff Organ
204	000	000	022	Accordion
205	000	000	023	Harmonica
206	000	032	023	Harmonica 2
207	000	000	024	Tango Accordion
208	000	064	024	Tango Accordion 2
GUITAR				
209	000	000	025	Nylon Guitar
210	000	043	025	Velocity Guitar Harmonics
211	000	096	025	Ukulele
212	000	000	026	Steel Guitar
213	000	035	026	12-string Guitar
214	000	040	026	Nylon & Steel Guitar
215	000	041	026	Steel Guitar with Body Sound
216	000	096	026	Mandolin
217	000	000	027	Jazz Guitar
218	000	032	027	Jazz Amp
219	000	000	028	Clean Guitar
220	000	032	028	Chorus Guitar
221	000	000	029	Muted Guitar
222	000	040	029	Funk Guitar 1
223	000	041	029	Muted Steel Guitar
224	000	045	029	Jazz Man
225	000	000	030	Overdriven Guitar
226	000	043	030	Guitar Pinch

Voice List

Voice No.	Bank Select		MIDI Program Change# (1 - 128)	Voice Name
	MSB (0 - 127)	LSB (0 - 127)		
227	000	000	031	Distortion Guitar
228	000	040	031	Feedback Guitar
229	000	041	031	Feedback Guitar 2
230	000	000	032	Guitar Harmonics
231	000	065	032	Guitar Feedback
232	000	066	032	Guitar Harmonics 2
BASS				
233	000	000	033	Acoustic Bass
234	000	040	033	Jazz Rhythm
235	000	045	033	Velocity Crossfade Upright Bass
236	000	000	034	Finger Bass
237	000	018	034	Finger Dark
238	000	040	034	Bass & Distorted Electric Guitar
239	000	043	034	Finger Slap Bass
240	000	045	034	Finger Bass 2
241	000	065	034	Modulated Bass
242	000	000	035	Pick Bass
243	000	028	035	Muted Pick Bass
244	000	000	036	Fretless Bass
245	000	032	036	Fretless Bass 2
246	000	033	036	Fretless Bass 3
247	000	034	036	Fretless Bass 4
248	000	000	037	Slap Bass 1
249	000	032	037	Punch Thumb Bass
250	000	000	038	Slap Bass 2
251	000	043	038	Velocity Switch Slap
252	000	000	039	Synth Bass 1
253	000	040	039	Techno Synth Bass
254	000	000	040	Synth Bass 2
255	000	006	040	Mellow Synth Bass
256	000	012	040	Sequenced Bass
257	000	018	040	Click Synth Bass
258	000	019	040	Synth Bass 2 Dark
*259	000	040	040	Modular Synth Bass
260	000	041	040	DX Bass
STRING				
261	000	000	041	Violin
262	000	008	041	Slow Violin
263	000	000	042	Viola
264	000	000	043	Cello
265	000	000	044	Contrabass
266	000	000	045	Tremolo Strings
267	000	008	045	Slow Tremolo Strings
268	000	040	045	Suspense Strings
269	000	000	046	Pizzicato Strings
270	000	000	047	Orchestral Harp
271	000	040	047	Yang Chin
272	000	000	048	Timpani
ENSEMBLE				
273	000	000	049	Strings 1
274	000	003	049	Stereo Strings
275	000	008	049	Slow Strings
276	000	035	049	60's Strings
277	000	040	049	Orchestra
278	000	041	049	Orchestra 2
279	000	042	049	Tremolo Orchestra
280	000	045	049	Velocity Strings
281	000	000	050	Strings 2
282	000	003	050	Stereo Slow Strings
283	000	008	050	Legato Strings
284	000	040	050	Warm Strings
285	000	041	050	Kingdom
286	000	000	051	Synth Strings 1
287	000	000	052	Synth Strings 2
288	000	000	053	Choir Aahs
289	000	003	053	Stereo Choir
290	000	032	053	Mellow Choir
291	000	040	053	Choir Strings
292	000	000	054	Voice Oohs
293	000	000	055	Synth Voice
294	000	040	055	Synth Voice 2
295	000	041	055	Choral
296	000	064	055	Analog Voice

Voice No.	Bank Select		MIDI Program Change# (1 - 128)	Voice Name
	MSB (0 - 127)	LSB (0 - 127)		
297	000	000	056	Orchestra Hit
298	000	035	056	Orchestra Hit 2
299	000	064	056	Impact
BRASS				
300	000	000	057	Trumpet
301	000	032	057	Warm Trumpet
302	000	000	058	Trombone
303	000	018	058	Trombone 2
304	000	000	059	Tuba
305	000	000	060	Muted Trumpet
306	000	000	061	French Horn
307	000	006	061	French Horn Solo
308	000	032	061	French Horn 2
309	000	037	061	Horn Orchestra
310	000	000	062	Brass Section
311	000	035	062	Trumpet & Trombone Section
312	000	000	063	Synth Brass 1
313	000	020	063	Resonant Synth Brass
314	000	000	064	Synth Brass 2
315	000	018	064	Soft Brass
316	000	041	064	Choir Brass
REED				
317	000	000	065	Soprano Sax
318	000	000	066	Alto Sax
319	000	040	066	Sax Section
320	000	000	067	Tenor Sax
321	000	040	067	Breathy Tenor Sax
322	000	000	068	Baritone Sax
323	000	000	069	Oboe
324	000	000	070	English Horn
325	000	000	071	Bassoon
326	000	000	072	Clarinet
PIPE				
327	000	000	073	Piccolo
328	000	000	074	Flute
329	000	000	075	Recorder
330	000	000	076	Pan Flute
331	000	000	077	Blown Bottle
332	000	000	078	Shakuhachi
333	000	000	079	Whistle
334	000	000	080	Ocarina
SYNTH LEAD				
335	000	000	081	Square Lead
336	000	006	081	Square Lead 2
337	000	008	081	LM Square
338	000	018	081	Hollow
339	000	019	081	Shroud
340	000	064	081	Mellow
341	000	065	081	Solo Sine
342	000	066	081	Sine Lead
343	000	000	082	Sawtooth Lead
344	000	006	082	Sawtooth Lead 2
345	000	008	082	Thick Sawtooth
346	000	018	082	Dynamic Sawtooth
347	000	019	082	Digital Sawtooth
348	000	020	082	Big Lead
349	000	096	082	Sequenced Analog
350	000	000	083	Calliope Lead
351	000	065	083	Pure Pad
352	000	000	084	Chiff Lead
353	000	000	085	Charang Lead
354	000	064	085	Distorted Lead
355	000	000	086	Voice Lead
356	000	000	087	Fifths Lead
357	000	035	087	Big Five
358	000	000	088	Bass & Lead
359	000	016	088	Big & Low
360	000	064	088	Fat & Perky
361	000	065	088	Soft Whirl
SYNTH PAD				
362	000	000	089	New Age Pad
363	000	064	089	Fantasy
364	000	000	090	Warm Pad

Voice No.	Bank Select		MIDI Program Change# (1 - 128)	Voice Name
	MSB (0 - 127)	LSB (0 - 127)		
365	000	000	091	Poly Synth Pad
366	000	000	092	Choir Pad
367	000	066	092	Itopia
368	000	000	093	Bowed Pad
369	000	000	094	Metallic Pad
370	000	000	095	Halo Pad
371	000	000	096	Sweep Pad
SYNTH EFFECTS				
372	000	000	097	Rain
373	000	065	097	African Wind
374	000	066	097	Carib
375	000	000	098	Sound Track
376	000	027	098	Prologue
377	000	000	099	Crystal
378	000	012	099	Synth Drum Comp
379	000	014	099	Popcorn
380	000	018	099	Tiny Bells
381	000	035	099	Round Glockenspiel
382	000	040	099	Glockenspiel Chimes
383	000	041	099	Clear Bells
384	000	042	099	Chorus Bells
385	000	065	099	Soft Crystal
386	000	070	099	Air Bells
387	000	071	099	Bell Harp
388	000	072	099	Gamelimba
389	000	000	100	Atmosphere
390	000	018	100	Warm Atmosphere
391	000	019	100	Hollow Release
392	000	040	100	Nylon Electric Piano
393	000	064	100	Nylon Harp
394	000	065	100	Harp Vox
395	000	066	100	Atmosphere Pad
396	000	000	101	Brightness
397	000	000	102	Goblins
398	000	064	102	Goblins Synth
399	000	065	102	Creeper
400	000	067	102	Ritual
401	000	068	102	To Heaven
402	000	070	102	Night
403	000	071	102	Glisten
404	000	096	102	Bell Choir
405	000	000	103	Echoes
406	000	000	104	Sci-Fi
WORLD				
407	000	000	105	Sitar
408	000	032	105	Detuned Sitar
409	000	035	105	Sitar 2
410	000	097	105	Tamboura
411	000	000	106	Banjo
412	000	028	106	Muted Banjo
413	000	096	106	Rabab
414	000	097	106	Gopichant
415	000	098	106	Oud
416	000	000	107	Shamisen
417	000	000	108	Koto
418	000	096	108	Taisho-kin
419	000	097	108	Kanoon
420	000	000	109	Kalimba
421	000	000	110	Bagpipe
422	000	000	111	Fiddle
423	000	000	112	Shanai
PERCUSSIVE				
424	000	000	113	Tinkle Bell
425	000	096	113	Bonang
426	000	097	113	Altair
427	000	098	113	Gamelan Gongs
428	000	099	113	Stereo Gamelan Gongs
429	000	100	113	Rama Cymbal
430	000	000	114	Agogo
431	000	000	115	Steel Drums
432	000	097	115	Glass Percussion
433	000	098	115	Thai Bells
434	000	000	116	Woodblock

Voice No.	Bank Select		MIDI Program Change# (1 - 128)	Voice Name
	MSB (0 - 127)	LSB (0 - 127)		
435	000	096	116	Castanets
436	000	000	117	Taiko Drum
437	000	096	117	Gran Cassa
438	000	000	118	Melodic Tom
439	000	064	118	Melodic Tom 2
440	000	065	118	Real Tom
441	000	066	118	Rock Tom
442	000	000	119	Synth Drum
443	000	064	119	Analog Tom
444	000	065	119	Electronic Percussion
445	000	000	120	Reverse Cymbal
SOUND EFFECTS				
446	000	000	121	Fret Noise
447	000	000	122	Breath Noise
448	000	000	123	Seashore
449	000	000	124	Bird Tweet
450	000	000	125	Telephone Ring
451	000	000	126	Helicopter
452	000	000	127	Applause
453	000	000	128	Gunshot
454	064	000	001	Cutting Noise
455	064	000	002	Cutting Noise 2
456	064	000	004	String Slap
457	064	000	017	Flute Key Click
458	064	000	033	Shower
459	064	000	034	Thunder
460	064	000	035	Wind
461	064	000	036	Stream
462	064	000	037	Bubble
463	064	000	038	Feed
464	064	000	049	Dog
465	064	000	050	Horse
466	064	000	051	Bird Tweet 2
467	064	000	056	Maou
468	064	000	065	Phone Call
469	064	000	066	Door Squeak
470	064	000	067	Door Slam
471	064	000	068	Scratch Cut
472	064	000	069	Scratch Split
473	064	000	070	Wind Chime
474	064	000	071	Telephone Ring 2
475	064	000	081	Car Engine Ignition
476	064	000	082	Car Tires Squeal
477	064	000	083	Car Passing
478	064	000	084	Car Crash
479	064	000	085	Siren
480	064	000	086	Train
481	064	000	087	Jet Plane
482	064	000	088	Starship
483	064	000	089	Burst
484	064	000	090	Roller Coaster
485	064	000	091	Submarine
486	064	000	097	Laugh
487	064	000	098	Scream
488	064	000	099	Punch
489	064	000	100	Heartbeat
490	064	000	101	Footsteps
491	064	000	113	Machine Gun
492	064	000	114	Laser Gun
493	064	000	115	Explosion
494	064	000	116	Firework

The voice number with an asterisk (*) is XGlite optional voice.



Drum Kit List

- “ ” indicates that the drum sound is the same as “Standard Kit 1”.
- Each percussion voice uses one note.
- The MIDI Note # and Note are actually one octave lower than keyboard Note # and Note. For example, in “122: Standard Kit 1”, the “Seq Click H” (Note# 36/Note C1) corresponds to (Note# 24/Note C0).
- Key Off: Keys marked “O” stop sounding the instant they are released.
- Voices with the same Alternate Note Number (*1 ... 4) cannot be played simultaneously. (They are designed to be played alternately with each other.)

	Voice No.						122	123	124	125	126	127
	MSB (0 - 127)		LSB (0 - 127)		PC (1 - 128)		127/000/001	127/000/002	127/000/009	127/000/017	127/000/025	127/000/026
	Keyboard	MIDI	Key Off	Alternate assign	Standard Kit 1	Standard Kit 2	Room Kit	Rock Kit	Electronic Kit	Analog Kit		
	Note#	Note	Note#	Note								
D0	C#0	25 C# 0	13 C# -1		3	Surdo Mute						
	D#0	26 D 0	14 D -1		3	Surdo Open						
E0	D#0	27 D# 0	15 D# -1			Hi Q						
	F#0	28 E 0	16 E -1			Whip Slap						
F0	F#0	29 F 0	17 F -1		4	Scratch Push						
	G#0	30 F# 0	18 F# -1		4	Scratch Pull						
G0	G#0	31 G 0	19 G -1			Finger Snap						
	A#0	32 G# 0	20 G# -1			Click Noise						
A0	A#0	33 A 0	21 A -1			Metronome Click						
	B#0	34 A# 0	22 A# -1			Metronome Bell						
B0	B#0	35 B 0	23 B -1			Seq Click L						
	C#1	36 C 1	24 C 0			Seq Click H						
C1	C#1	37 C# 1	25 C# 0			Brush Tap						
	D#1	38 D 1	26 D 0	O		Brush Swirl						
D1	D#1	39 D# 1	27 D# 0			Brush Slap						
	F#1	40 E 1	28 E 0	O		Brush Tap Swirl				Reverse Cymbal	Reverse Cymbal	
E1	F#1	41 F 1	29 F 0	O		Snare Roll						
	G#1	42 F# 1	30 F# 0			Castanet				Hi Q 2	Hi Q 2	
G1	G#1	43 G 1	31 G 0			Snare H Soft	Snare H Soft 2		SD Rock H	Snare L	SD Rock H	
	A#1	44 G# 1	32 G# 0			Sticks						
A1	A#1	45 A 1	33 A 0			Bass Drum Soft				Bass Drum H	Bass Drum H	
	C#2	46 A# 1	34 A# 0			Open Rim Shot	Open Rim Shot 2					
B1	C#2	47 B 1	35 B 0			Bass Drum Hard			Bass Drum H	BD Rock	BD Analog L	
	D#2	48 C 2	36 C 1			Bass Drum	Bass Drum 2		BD Rock	BD Gate	BD Analog H	
C2	D#2	49 C# 2	37 C# 1			Side Stick					Analog Side Stick	
	F#2	50 D 2	38 D 1			Snare M	Snare M 2	SD Room L	SD Rock L	SD Rock L	Analog Snare 1	
D2	F#2	51 D# 2	39 D# 1			Hand Clap						
	G#2	52 E 2	40 E 1			Snare H Hard	Snare H Hard 2	SD Room H	SD Rock Rim	SD Rock H	Analog Snare 2	
E2	G#2	53 F 2	41 F 1			Floor Tom L		Room Tom 1	Rock Tom 1	E Tom 1	Analog Tom 1	
	A#2	54 F# 2	42 F# 1	1		Hi-Hat Closed					Analog HH Closed 1	
G2	A#2	55 G 2	43 G 1			Floor Tom H		Room Tom 2	Rock Tom 2	E Tom 2	Analog Tom 2	
	C#3	56 G# 2	44 G# 1	1		Hi-Hat Pedal					Analog HH Closed 2	
A2	C#3	57 A 2	45 A 1			Low Tom		Room Tom 3	Rock Tom 3	E Tom 3	Analog Tom 3	
	D#3	58 A# 2	46 A# 1	1		Hi-Hat Open					Analog HH Open	
B2	D#3	59 B 2	47 B 1			Mid Tom L		Room Tom 4	Rock Tom 4	E Tom 4	Analog Tom 4	
	F#3	60 C 3	48 C 2			Mid Tom H		Room Tom 5	Rock Tom 5	E Tom 5	Analog Tom 5	
C3	F#3	61 C# 3	49 C# 2			Crash Cymbal 1					Analog Cymbal	
	G#3	62 D 3	50 D 2			High Tom		Room Tom 6	Rock Tom 6	E Tom 6	Analog Tom 6	
D3	G#3	63 D# 3	51 D# 2			Ride Cymbal 1						
	A#3	64 E 3	52 E 2			Chinese Cymbal						
E3	A#3	65 F 3	53 F 2			Ride Cymbal Cup						
	C#4	66 F# 3	54 F# 2			Tambourine						
G3	C#4	67 G 3	55 G 2			Splash Cymbal						
	D#4	68 G# 3	56 G# 2			Cowbell					Analog Cowbell	
A3	D#4	69 A 3	57 A 2			Crash Cymbal 2						
	F#4	70 A# 3	58 A# 2			Vibraslap						
B3	F#4	71 B 3	59 B 2			Ride Cymbal 2						
	G#4	72 C 4	60 C 3			Bongo H						
C4	G#4	73 C# 4	61 C# 3			Bongo L						
	A#4	74 D 4	62 D 3			Conga H Mute					Analog Conga H	
D4	A#4	75 D# 4	63 D# 3			Conga H Open					Analog Conga M	
	C#5	76 E 4	64 E 3			Conga L					Analog Conga L	
E4	C#5	77 F 4	65 F 3			Timbale H						
	D#5	78 F# 4	66 F# 3			Timbale L						
G4	D#5	79 G 4	67 G 3			Agogo H						
	F#5	80 G# 4	68 G# 3			Agogo L						
A4	F#5	81 A 4	69 A 3			Cabasa						
	G#5	82 A# 4	70 A# 3			Maracas					Analog Maracas	
B4	G#5	83 B 4	71 B 3	O		Samba Whistle H						
	C#6	84 C 5	72 C 4	O		Samba Whistle L						
C5	C#6	85 C# 5	73 C# 4			Guiro Short						
	D#6	86 D 5	74 D 4	O		Guiro Long						
D5	D#6	87 D# 5	75 D# 4			Claves					Analog Claves	
	F#6	88 E 5	76 E 4			Wood Block H						
E5	F#6	89 F 5	77 F 4			Wood Block L						
	G#6	90 F# 5	78 F# 4			Cuica Mute				Scratch Push	Scratch Push	
G5	G#6	91 G 5	79 G 4			Cuica Open				Scratch Pull	Scratch Pull	
	A#5	92 G# 5	80 G# 4	2		Triangle Mute						
A5	A#5	93 A 5	81 A 4	2		Triangle Open						
	C#6	94 A# 5	82 A# 4			Shaker						
B5	C#6	95 B 5	83 B 4			Jingle Bell						
	D#6	96 C 6	84 C 5			Bell Tree						
C6	D#6	97 C# 6	85 C# 5									
	F#6	98 D 6	86 D 5									
D6	F#6	99 D# 6	87 D# 5									
	G#6	100 E 6	88 E 5									
E6	G#6	101 F 6	89 F 5									
	A#6	102 F# 6	90 F# 5									
F6	A#6	103 G 6	91 G 5									

		Voice No.					122	128	129	130	131	132	133	
		MSB (0 - 127) / LSB (0 - 127) / PC (1 - 128)					127/000/001	127/000/028	127/000/033	127/000/041	127/000/049	126/000/001	126/000/002	
		Keyboard		MIDI		Key Off	Alternate assign	Standard Kit 1	Dance Kit	Jazz Kit	Brush Kit	Symphony Kit	SFX Kit 1	SFX Kit 2
		Note#	Note	Note#	Note									
D0	C#0	25	C# 0	13	C# -1		3	Surdo Mute						
		26	D 0	14	D -1		3	Surdo Open						
E0	D#0	27	D# 0	15	D# -1			Hi Q						
		28	E 0	16	E -1			Whip Slap						
F0	F#0	29	F 0	17	F -1		4	Scratch Push						
		30	F# 0	18	F# -1		4	Scratch Pull						
G0	G#0	31	G 0	19	G -1			Finger Snap						
		32	G# 0	20	G# -1			Click Noise						
A0	A#0	33	A 0	21	A -1			Metronome Click						
		34	A# 0	22	A# -1			Metronome Bell						
B0		35	B 0	23	B -1			Seq Click L						
		36	C 1	24	C 0			Seq Click H						
C1	C#1	37	C# 1	25	C# 0			Brush Tap						
		38	D 1	26	D 0	O		Brush Swirl						
D1	D#1	39	D# 1	27	D# 0			Brush Slap						
		40	E 1	28	E 0	O		Brush Tap Swirl	Reverse Cymbal					
E1		41	F 1	29	F 0	O		Snare Roll						
F1	F#1	42	F# 1	30	F# 0			Castanet	Hi Q 2					
		43	G 1	31	G 0			Snare H Soft	AnSD Snappy	SD Jazz H Light	Brush Slap L			
G1	G#1	44	G# 1	32	G# 0			Sticks						
		45	A 1	33	A 0			Bass Drum Soft	AnBD Dance-1			Bass Drum L		
A1	A#1	46	A# 1	34	A# 0			Open Rim Shot	AnSD OpenRim					
		47	B 1	35	B 0			Bass Drum Hard	AnBD Dance-2			Gran Cassa		
B1		48	C 2	36	C 1			Bass Drum	AnBD Dance-3	BD Jazz	BD Jazz	Gran Cassa Mute	Cutting Noise	Phone Call
		49	C# 2	37	C# 1			Side Stick	Analog Side Stick			Cutting Noise 2	Door Squeak	
C2	C#2	50	D 2	38	D 1			Snare M	AnSD Q	SD Jazz L	Brush Slap	Marching Sn M	Door Slam	
		51	D# 2	39	D# 1			Hand Clap				String Slap	Scratch Cut	
D2	D#2	52	E 2	40	E 1			Snare H Hard	AnSD Ana+Acoustic	SD Jazz M	Brush Tap	Marching Sn H	Scratch	
		53	F 2	41	F 1			Floor Tom L	Analog Tom 1	Jazz Tom 1	Brush Tom 1	Jazz Tom 1	Wind Chime	
F2	F#2	54	F# 2	42	F# 1	1		Hi-Hat Closed	Analog HH Closed 3				Telephone Ring 2	
		55	G 2	43	G 1			Floor Tom H	Analog Tom 2	Jazz Tom 2	Brush Tom 2	Jazz Tom 2		
G2	G#2	56	G# 2	44	G# 1	1		Hi-Hat Pedal	Analog HH Closed 4					
		57	A 2	45	A 1			Low Tom	Analog Tom 3	Jazz Tom 3	Brush Tom 3	Jazz Tom 3		
A2	A#2	58	A# 2	46	A# 1	1		Hi-Hat Open	Analog HH Open 2					
		59	B 2	47	B 1			Mid Tom L	Analog Tom 4	Jazz Tom 4	Brush Tom 4	Jazz Tom 4		
B2		60	C 3	48	C 2			Mid Tom H	Analog Tom 5	Jazz Tom 5	Brush Tom 5	Jazz Tom 5		
C3	C#3	61	C# 3	49	C# 2			Crash Cymbal 1	Analog Cymbal			Hand Cym. L		
		62	D 3	50	D 2			High Tom	Analog Tom 6	Jazz Tom 6	Brush Tom 6	Jazz Tom 6		
D3	D#3	63	D# 3	51	D# 2			Ride Cymbal 1				Hand Cym.Short L		
		64	E 3	52	E 2			Chinese Cymbal				Flute Key Click	Car Engine Ignition	
E3		65	F 3	53	F 2			Ride Cymbal Cup					Car Tires Squeal	
F3	F#3	66	F# 3	54	F# 2			Tambourine					Car Passing	
		67	G 3	55	G 2			Splash Cymbal					Car Crash	
G3	G#3	68	G# 3	56	G# 2			Cowbell	Analog Cowbell				Siren	
		69	A 3	57	A 2			Crash Cymbal 2				Hand Cym. H	Train	
A3	A#3	70	A# 3	58	A# 2			Vibraslap					Jet Plane	
		71	B 3	59	B 2			Ride Cymbal 2				Hand Cym.Short H	Starship	
B3		72	C 4	60	C 3			Bongo H					Burst	
		73	C# 4	61	C# 3			Bongo L					Roller Coaster	
C4	C#4	74	D 4	62	D 3			Conga H Mute	Analog Conga H				Submarine	
		75	D# 4	63	D# 3			Conga H Open	Analog Conga M					
D4	D#4	76	E 4	64	E 3			Conga L	Analog Conga L					
		77	F 4	65	F 3			Timbale H						
F4	F#4	78	F# 4	66	F# 3			Timbale L						
		79	G 4	67	G 3			Agogo H						
G4	G#4	80	G# 4	68	G# 3			Agogo L					Shower	Laugh
		81	A 4	69	A 3			Cabasa				Thunder	Scream	
A4	A#4	82	A# 4	70	A# 3			Maracas	Analog Maracas			Wind	Punch	
		83	B 4	71	B 3	O		Samba Whistle H				Stream	Heartbeat	
B4		84	C 5	72	C 4	O		Samba Whistle L				Bubble	FootSteps	
		85	C# 5	73	C# 4			Guiro Short				Feed		
C5	C#5	86	D 5	74	D 4	O		Guiro Long						
		87	D# 5	75	D# 4			Claves	Analog Claves					
D5	D#5	88	E 5	76	E 4			Wood Block H						
		89	F 5	77	F 4			Wood Block L						
F5	F#5	90	F# 5	78	F# 4			Cuica Mute	Scratch Push					
		91	G 5	79	G 4			Cuica Open	Scratch Pull					
G5	G#5	92	G# 5	80	G# 4		2	Triangle Mute						
		93	A 5	81	A 4		2	Triangle Open						
A5	A#5	94	A# 5	82	A# 4			Shaker						
		95	B 5	83	B 4			Jingle Bell						
B5		96	C 6	84	C 5			Bell Tree				Dog	Machine Gun	
		97	C# 6	85	C# 5							Horse	Laser Gun	
C6	C#6	98	D 6	86	D 5							Bird Tweet 2	Explosion	
		99	D# 6	87	D# 5								Firework	
D6	D#6	100	E 6	88	E 5									
		101	F 6	89	F 5									
F6	F#6	102	F# 6	90	F# 5									
		103	G 6	91	G 5							Maou		



Style List

Style No.	Style Name
8BEAT	
001	8BeatModern
002	60'sGuitarPop
003	8BeatAdria
004	60's8Beat
005	8Beat
006	OffBeat
007	60'sRock
008	HardRock
009	RockShuffle
010	8BeatRock
16BEAT	
011	16Beat
012	PopShuffle1
013	PopShuffle2
014	GuitarPop
015	16BeatUptempo
016	KoolShuffle
017	JazzRock
018	HipHopLight
BALLAD	
019	PianoBallad
020	LoveSong
021	6/8ModernEP
022	6/8SlowRock
023	OrganBallad
024	PopBallad
025	16BeatBallad1
026	16BeatBallad2
DANCE	
027	EuroTrance
028	Ibiza
029	HouseMusik
030	SwingHouse
031	TechnoPolis
032	Clubdance
033	ClubLatin
034	Garage1
035	Garage2
036	TechnoParty
037	UKPop
038	HipHopGroove
039	HipShuffle
040	HipHopPop
DISCO	
041	70'sDisco1
042	70'sDisco2
043	LatinDisco
044	DiscoPhilly
045	SaturdayNight
046	DiscoChocolate
047	DiscoHands
SWING&JAZZ	
048	BigBandFast
049	BigBandMedium
050	BigBandBallad
051	BigBandShuffle
052	JazzClub
053	Swing1

Style No.	Style Name
054	Swing2
055	Five/Four
056	JazzBallad
057	Dixieland
058	Ragtime
059	AfroCuban
060	Charleston
R&B	
061	Soul
062	DetroitPop1
063	60'sRock&Roll
064	6/8Soul
065	CrocoTwist
066	Rock&Roll
067	DetroitPop2
068	BoogieWoogie
069	ComboBoogie
070	6/8Blues
COUNTRY	
071	Country8Beat
072	CountryPop
073	CountrySwing
074	Country2/4
075	CowboyBoogie
076	CountryShuffle
077	Bluegrass
LATIN	
078	BrazilianSamba
079	BossaNova
080	PopBossa
081	Tijuana
082	DiscoLatin
083	Mambo
084	Salsa
085	Beguine
086	GuitarRumba
087	RumbaFlamenca
088	RumbalIsland
089	Reggae
BALLROOM	
090	VienneseWaltz
091	EnglishWaltz
092	Slowfox
093	Foxtrot
094	Quickstep
095	Tango
096	Pasodoble
097	Samba
098	ChaChaCha
099	Rumba
100	Jive
TRADITIONAL	
101	USMarch
102	6/8March
103	GermanMarch
104	PolkaPop
105	OberPolka
106	Tarantella
107	Showtune

Style No.	Style Name
108	ChristmasSwing
109	ChristmasWaltz
110	ScottishReel
111	Hawaiian
WALTZ	
112	GuitarSerenade
113	SwingWaltz
114	JazzWaltz1
115	JazzWaltz2
116	CountryWaltz
117	OberWaltzer
118	Musette
DJ	
119	DJ-HipHop
120	DJ-DanceSwing
121	DJ-House
122	DJ-GarageHouse
123	DJ-PopR&B
PIANIST	
124	Stride
125	PianoSwing
126	PianoRag
127	Arpeggio
128	Musical
129	Habanera
130	SlowRock
131	8BtPianoBallad
132	PianoMarch
133	6/8PianoMarch
134	PianoWaltz
135	PianoBeguine



Song List

● Preset Songs

Song No.	Song Name
Favorites	
001	Don't Know Why (Jesse Harris (Norah Jones))
002	My Favorite Things (Richard Rodgers)
003	Fly Me To The Moon (Bart Howard)
Easy Play	
004	Down By The Riverside (Traditional)
005	I've Been Working On The Railroad (Traditional)
006	Carry Me Back To Old Virginny (James A. Bland)
007	The Last Rose Of Summer (Thomas Moore)
008	The First Noel (Traditional (English))
Pianist	
009	The Entertainer (S. Joplin)
010	Greensleeves (Traditional)
011	Londonderry Air (Traditional)
012	Traumerei (R. Schumann)
013	Pastorale (J.F. Burgmüller)
Organist	
014	Wedding March From A Midsummer Night's Dream (F. Mendelssohn)
015	Allein Gott In Der Hoh Sei Eh (N. Decius)
016	Wachet Auf, Ruft Uns Die Stimme. (J.S. Bach)
Advanced	
017	Menuett In G Major Wo 10-2 (L.v. Beethoven)
018	Prelude Op.28 No.7 (F. Chopin)
019	To A Wild Rose (E.A. Macdowell)
020	Für Elise (L.v. Beethoven)
021	Etude Op.10-3 "Chanson de l'adieu" (F. Chopin)
Band Play	
022	Aura Lee (G. Poulton)
023	Canon (J. Pachelbel)
024	Symphonie Nr.9 (L.v. Beethoven)
Duet	
025	Sur Le Pont D'Avignon (Traditional)
026	Twinkle Twinkle Little Star (Traditional)
027	Muffin Man (Traditional)
Holidays	
028	Joy To The World (G.F. Händel)
029	Ave Maria (F. Schubert)
030	Jingle Bells (Traditional)

● 70 MIDI Songs Provided On the Supplied CD-ROM

File Name	Song Name
AMERICA	America The Beautiful (S.A. Ward)
ATHOME	Old Folks At Home (S.C. Foster)
AURALEE	Aura Lee (G. Poulton)
BABBINO	O Mio Babbino Caro (From "Gianni Schicchi") (G. Puccini)
BANJO	Ring De Banjo (S.C. Foster)
BILLBAIL	Bill Bailey (Won't You Please Come Home) (H. Cannon)
BROWNJUG	Little Brown Jug (Traditional)
CAMPTOWN	Camptown Races (S.C. Foster)
CANON	Canon (J. Pachelbel)
D_AGSTIN	O Du Lieber Augustin (DUET) (Traditional)
D_CHTREE	O Christmas Tree (DUET) (Traditional)
D_CLOSE	Close Your Hands, Open Your Hands (DUET) (J.J. Rousseau)
D_CUCKOO	The Cuckoo (DUET) (Traditional)
D_IMMAI	Im Mai (DUET) (Traditional)
D_INDIAN	Ten Little Indians (DUET) (Septimus Winner)
D_LONDON	London Bridge (DUET) (Traditional)
D_MARY	Mary Had A Little Lamb (DUET) (Traditional)

File Name	Song Name
D_ROWROW	Row Row Row Your Boat (DUET) (Traditional)
D_SCARBO	Scarborough Fair (DUET) (Traditional)
D_SMOKY	On Top Of Old Smoky (DUET) (Traditional)
D_THREE	Three Blind Mice (DUET) (Traditional)
D_WEASEL	Pop Goes The Weasel (DUET) (Traditional)
D_WEWISH	We Wish You A Merry Christmas (DUET) (Traditional)
DANUBEWA	The Danube Waves (I. Ivanovici)
FRULIED	Frühlingslied (F. Mendelssohn)
FRUSTIME	Frühlingsstimmen (J. Strauss II)
FUNICULA	Funiculi-Funicula (L. Denza)
GAVOTTE	Gavotte (F.J. Gossec)
GUILLAUM	Guillaume Tell (G. Rossini)
IRISHEYE	When Irish Eyes Are Smiling (E.R. Ball)
JOYOFMAN	Jesu, Joy Of Man's Desiring (J.S. Bach)
LIEBEST3	Liebesträume Nr.3 (F. Liszt)
LOMOND	Loch Lomond (Traditional)
LORELEI	Die Lorelei (F. Silcher)
MAGICFLT	From "The Magic Flute" (W.A. Mozart)
MIRLITON	Danse Des Mirlitons From "The Nutcracker" (P.I. Tchaikovsky)
MONDSHIN	Piano Sonate Op.27-2 "Mondschein" (L.v. Beethoven)
MUSSIDEN	Muss I Denn (F. Silcher)
MYBONNIE	My Bonnie (Traditional)
ORPHEE	"Orphée Aux Enfers" Ouverture (J. Offenbach)
P_ANGELS	Angels Serenade (Traditional)
P_ARABES	Arabesque (J.F. Burgmüller)
P_CANDEU	La Candeur (J.F. Burgmüller)
P_CHEVAL	La Chevaleresque (J.F. Burgmüller)
P_CONSOL	Consolation (J.F. Burgmüller)
P_INOCEN	Innocence (J.F. Burgmüller)
P_MENUUBA	Menuett (J.S. Bach)
P_MENUUBO	Menuett (L. Boccherini)
P_MOMENT	Moments Musicaux Op.94-3 (F. Schubert)
P_PCHIEN	Valse Op.64-1 "Petit Chien" (F. Chopin)
P_PETITE	Petite Réunion (J.F. Burgmüller)
P_PROGRE	Progrès (J.F. Burgmüller)
P_SARAFa	Krasnyj Sarafan (Traditional)
P_TENDRE	Tendre Fleur (J.F. Burgmüller)
P_TMARCH	Turkish March (W.A. Mozart)
P_VIOLET	La Violette (Streabbog)
PEARLFIS	Song Of The Pearl Fisher (G. Bizet)
PRIMVERA	La Primavera (From Le Quattro Stagioni) (A. Vivaldi)
SAINTSGO	When The Saints Go Marchin' In (Traditional)
SERENAHY	String Quartet No.17 2nd Mov. "Serenade" (F.J. Haydn)
SILENTNT	Silent Night (F. Gruber)
SLAVON10	Slavonic Dances No.10 (A. Dvořák)
SURPRISE	"The Surprise" Symphony (F.J. Haydn)
SUSANNA	Oh! Susanna (S.C. Foster)
SYMPHO9	Symphonie Nr.9 (L.v. Beethoven)
THAIS	Méditation De Thais (J. Massenet)
TOREADOR	Air de Toréador "Carmen" (G. Bizet)
TURKEY	Turkey In The Straw (Traditional)
UNGARIS5	Ungarische Tänze Nr.5 (J. Brahms)
VOGLEIN	Wenn Ich Ein Vöglein Wär? (Traditional)

File names that begin with "P_" do not include chord data, they cannot be used with the performance assistant Chord type.



Effect Type List

● Harmony Types

No.	Harmony Type	Description
01	Duet	Harmony types 01 – 05 are pitch-based and add one-, two- or three-note harmonies to the single-note melody played in the right hand. These types only sound when chords are played in the auto accompaniment area of the keyboard.
02	Trio	
03	Block	
04	Country	
05	Octave	
06	Trill 1/4 note	<p>Types 6 – 26 are rhythm-based effects and add embellishments or delayed repeats in time with the auto accompaniment. These types sound whether the auto accompaniment is on or not; however, the actual speed of the effect depends on the Tempo setting (page 21). The individual note values in each type let you synchronize the effect precisely to the rhythm. Triplet settings are also available: 1/6 = quarter-note triplets, 1/12 = eighth-note triplets, 1/24 = sixteenth-note triplets.</p> <ul style="list-style-type: none"> • The Trill effect Types (06 – 12) create two-note trills (alternating notes) when two notes are held. • The Tremolo effect Types (13 – 19) repeat all held notes (up to four). • The Echo effect Types (20 – 26) create delayed repeats of each note played.
07	Trill 1/6 note	
08	Trill 1/8 note	
09	Trill 1/12 note	
10	Trill 1/16 note	
11	Trill 1/24 note	
12	Trill 1/32 note	
13	Tremolo 1/4 note	
14	Tremolo 1/6 note	
15	Tremolo 1/8 note	
16	Tremolo 1/12 note	
17	Tremolo 1/16 note	
18	Tremolo 1/24 note	
19	Tremolo 1/32 note	
20	Echo 1/4 note	
21	Echo 1/6 note	
22	Echo 1/8 note	
23	Echo 1/12 note	
24	Echo 1/16 note	
25	Echo 1/24 note	
26	Echo 1/32 note	

● Reverb Types

No.	Reverb Type	Description
01 – 03	Hall 1 – 3	Concert hall reverb.
04 – 05	Room 1 – 2	Small room reverb.
06 – 07	Stage 1 – 2	Reverb for solo instruments.
08 – 09	Plate 1 – 2	Simulated steel plate reverb.
10	Off	No effect.

● Chorus Types

No.	Chorus Type	Description
01 – 02	Chorus 1 – 2	Conventional chorus program with rich, warm chorusing.
03 – 04	Flanger 1 – 2	Pronounced three-phase modulation with a slight metallic sound.
05	Off	No effect.



MIDI Implementation Chart

YAMAHA [Portable Grand]
Model DGX-505/305

MIDI Implementation Chart

Date:1-DEC-2003
Version : 1.0

Function...	Transmitted	Recognized	Remarks
Basic Default Channel Changed	1 - 16 x	1 - 16 x	
Mode Default Messages Altered	3 x *****	3 x x	
Note Number : True voice	0 - 127 *****	0 - 127 0 - 127	
Velocity Note ON Note OFF	o 9nH, v=1-127 x	o 9nH, v=1-127 x	
After Key's Touch Ch's	x x	x x	
Pitch Bend	o	o	
Control Change	0,32 o 1 x *1 6 o 38 o 7 o 10 o 11 x *1 64 o 84 x *1 71 x *1 72 o 73 x *1 74 x *1 91,93 o 96,97 x 100,101 o	o o	Bank Select Modulation wheel Data Entry(MSB) Data Entry(LSB) Part Volume Pan Expression Sustain Portamento Cntrl Harmonic Content Release Time Attack Time Brightness Effect Depth RPN Inc,Dec RPN LSB,MSB
Prog Change : True #	o 0 - 127 *****	o 0 - 127	
System Exclusive	o *2	o *2	
: Song Pos. Common : Song Sel. : Tune	x x x	x x x	
System : Clock Real Time: Commands	o o	o o	
Aux :All Sound OFF :Reset All Cntrls :Local ON/OFF :All Notes OFF Mes- :Active Sense sages:Reset	x x x x o x	o(120,126,127) o(121) o(122) o(123-125) o x	

*1 Refer to #2 on page 106. *2 Refer to #3 on page 106.

Mode 1 : OMNI ON , POLY Mode 2 : OMNI ON , MONO o : Yes
Mode 3 : OMNI OFF, POLY Mode 4 : OMNI OFF, MONO x : No



MIDI Data Format

NOTE:

1 By default (factory settings) the instrument ordinarily functions as a 16-channel multi-timbral tone generator, and incoming data does not affect the panel voices or panel settings. However, the MIDI messages listed below do affect the panel voices, auto accompaniment, and songs.

- MIDI Master Tuning
- System exclusive messages for changing the Reverb Type and Chorus Type.

2 Messages for these control change numbers cannot be transmitted from the instrument itself. However, they may be transmitted when playing the accompaniment, song or using the Harmony effect.

3 Exclusive

<GM System ON> F0H, 7EH, 7FH, 09H, 01H, F7H

- This message automatically restores all default settings for the instrument, with the exception of MIDI Master Tuning.

<MIDI Master Volume> F0H, 7FH, 7FH, 04H, 01H, II, mm, F7H

- This message allows the volume of all channels to be changed simultaneously (Universal System Exclusive).
- The values of "mm" is used for MIDI Master Volume. (Values for "II" are ignored.)

<MIDI Master Tuning> F0H, 43H, 1nH, 27H, 30H, 00H, 00H, mm, II, cc, F7H

- This message simultaneously changes the tuning value of all channels.
- The values of "mm" and "II" are used for MIDI Master Tuning.
- The default value of "mm" and "II" are 08H and 00H, respectively. Any values can be used for "n" and "cc."

<Reverb Type> F0H, 43H, 1nH, 4CH, 02H, 01H, 00H, mmH, IIH, F7H

- mm : Reverb Type MSB
- II : Reverb Type LSB

Refer to the Effect Map (page 106) for details.

<Chorus Type> F0H, 43H, 1nH, 4CH, 02H, 01H, 20H, mmH, IIH, F7H

- mm : Chorus Type MSB
- II : Chorus Type LSB

Refer to the Effect Map (page 106) for details.

4 When the accompaniment is started, an FAH message is transmitted. When accompaniment is stopped, an FCH message is transmitted. When the clock is set to External, both FAH (accompaniment start) and FCH (accompaniment stop) are recognized.

5 Local ON/OFF

<Local ON> Bn, 7A, 7F

<Local OFF> Bn, 7A, 00

Value for "n" is ignored.

Effect map

* When a Type LSB value is received that corresponds to no effect type, a value corresponding to the effect type (coming the closest to the specified value) is automatically set.

* The numbers in parentheses in front of the Effect Type names correspond to the number indicated in the display.

REVERB

TYPE MSB	TYPE LSB								
	00	01	02	08	16	17	18	19	20
000	No Effect								
001	(01)Hall1				(02)Hall2	(03)Hall3			
002	Room					(04)Room1		(05)Room2	
003	Stage				(06)Stage1	(07)Stage2			
004	Plate				(08)Plate1	(09)Plate2			
005...127	No Effect								

CHORUS

TYPE MSB	TYPE LSB								
	00	01	02	08	16	17	18	19	20
000...063	No Effect								
064	Thru								
065	Chorus		(02)Chorus2						
066	Celeste					(01)Chorus1			
067	Flanger			(03)Flanger1		(04)Flanger2			
068...127	No Effect								



Index

Panel controls and terminals

+/-	14, 51
▶▶	15, 66
◀◀	15, 66
	14, 66
↙	52
A ↔ B	14, 65
▶/■	15, 51
0 – 9	14, 51
ACMP ON/OFF	14, 29
Card Slot	15, 73
CATEGORY ▲/▼	14, 51
DC IN 12V	10, 15
DEMO	14, 21
Dial	14, 51
DUAL	14, 24
EASY SONG ARRANGER	14, 43
EXECUTE	14, 74
EXIT	15, 52
FILE CONTROL	14, 73
FUNCTION	14, 52
HARMONY	14, 31
INTRO/ENDING/rit.	15, 30, 33, 34
LCD CONTRAST	15, 53
LESSON L/R	14, 39
LESSON MODE	14, 40
LESSON REPEAT & LEARN	14, 42
LYRICS	15, 38
MAIN/AUTO FILL	15, 31
MASTER VOLUME	13, 14, 50
MEMORY/BANK, 1, 2	15, 68
METRONOME	14, 56
PC	14, 81
PERFORMANCE ASSISTANT	14, 16, 18, 20
PHONES/OUTPUT	12, 15
PITCH BEND wheel	15, 27
PORTABLE GRAND	14, 27
REC, 1 – 5, A	15, 45, 48, 65
REGIST. MEMORY	15, 68
SCORE	15, 19, 37, 40
SONG	14, 35, 36
SONG MEMORY	15, 45, 48, 65
SPLIT	14, 25, 59
STANDBY/ON	13, 14, 49
START/STOP	15, 51
STYLE	14, 29, 33, 59
SUSTAIN	12, 15, 58, 71
SYNC START	14, 30
SYNC STOP	14, 33
TEMPO/TAP	15, 21, 56
TOUCH	14, 27, 57
USB	15, 80
VOICE	14, 23

Alphabetical order

A

A-B Repeat	65
Accessories (Optional)	95
Accessories (Supplied)	7
ACMP	29, 33, 53
Acrobat Reader	84, 85
Auto Accompaniment Range	30
Auto-Accompaniment	29, 33, 53
AWM	89

B

Backup	49
Battery	10
Bulk Send	72

C

CD-ROM	84
Channel Message	79
Chord	30, 61, 64
Chord (performance assistant technology)	16, 17, 20
CHORD ROOT	63
CHORD TYPE	63
Chorus	55
Chorus Type	71, 104
Computer	12, 36, 79, 81

D

D. Chorus Level	58, 71
D. Octave	58, 71
D. Pan	58, 71
D. Reverb Level	58, 71
D. Volume	58, 71
Default Setting	70
Delete	77
Demo	21
Demo Cancel	72
Dictionary	63
Display	52, 53
Double-Staff Score	37
Drum Kit	28, 97
Drum Kit List	100
Dual Voice	24

E

Easy Chords	61
Easy Song Arranger	14
Effect Map	106
Effect Type List	104
External Clock	72, 80
External Song	36

F

File	73
------	----

File Control	73
File Name	75
Flash Memory	36
Foot Switch	12
Format	74
Function	52, 70, 71, 72
Function Display	52, 70

G

Grade	41, 72
-------	--------

H

Harmony	14, 31, 58
Harmony Type	104
Harmony Volume	58
Headphones	12

I

Initial Send	72
Initialization	49

K

Keyboard Out	72
--------------	----

L

Language	22
Lesson	39
Load	77
Local	80
LOW BATTERY!!	53
L-Part	39, 72
Lyric	37, 38

M

M. Chorus Level	58, 71
M. Octave	58, 71
M. Pan	58, 71
M. Reverb Level	58, 71
M. Volume	58, 71
MAIN Display	52, 53
Main Voice	23
Measure	53
Media Select	67
Melody	19, 45
Melody (performance assistant technology)	18, 19, 20
Melody Score	37
Melody Voice	44, 67
Messages	91
Metronome	56
MIDI	80, 81
MIDI Data Format	106
MIDI Implementation Chart	105

Music Rest 7, 13
 Musicsoft Downloader 82, 84, 87
 Mute 65

N

notation 63

O

One Touch Setting 57

P

Panel Sustain 58, 71
 PC Mode 72, 81
 performance assistant technology
 16, 18, 20
 Pitch Bend Range 27, 71
 Power Adaptor 10
 Preset Song 35, 36

Q

Quantize 72

R

Recording 45
 Registration Memory 68
 Remote control 81
 Repeat 42, 65
 Reverb 54
 Reverb Type 104
 R-Part 39, 72

S

S. Chorus Level 58, 71
 S. Octave 58, 71
 S. Pan 58, 71
 S. Reverb Level 58, 71
 S. Volume 58, 71
 Score 15, 19, 37, 40
 Single-Staff Score 37
 SmartMedia Card 73
 SMF (Standard MIDI File) 76
 SMF Save 76
 Software Licensing Agreement 88
 Song 35, 36
 Song Clear 48
 Song List 103
 Song Memory 45, 48, 65
 Song Out 72
 Song Volume 65
 Specifications 95
 Split Point 25, 59
 Split Voice 25
 Standard Chords 61

Style 14, 29, 33, 59
 Style File (Style Number 136) 60
 Style List 102
 Style Out 72
 Style Volume 60
 Sustain 12
 Synchro Start 14, 30
 Synchro Stop 14, 33
 System Message 79

T

Tempo 21, 41, 56
 Time Signature 21, 56
 Touch Response 27
 Touch Sensitivity 57
 Track 45
 Track Clear 48
 Transfer 82, 83
 Transpose 66, 71
 Troubleshooting 88
 Tuning 66, 71

U

USB 15, 80
 USB MIDI Driver 80, 82, 84, 85
 User Data file 75, 77
 User Delete 77
 User File Save 75
 User Song 36, 45

V

Voice 23
 Voice List 96

X

XF 6, 38
 XGlite 6

Limited Warranty

90 DAYS LABOR

1 YEAR PARTS

Yamaha Corporation of America, hereafter referred to as Yamaha, warrants to the original consumer of a product included in the categories listed below, that the product will be free of defects in materials and/or workmanship for the periods indicated. This warranty is applicable to all models included in the following series of products:

PortableGrand™ SERIES OF ELECTRONIC KEYBOARDS

If during the first 90 days that immediately follows the purchase date, your new Yamaha product covered by this warranty is found to have a defect in material and/or workmanship, Yamaha and/or its authorized representative will repair such defect without charge for parts or labor.

If parts should be required after this 90 day period but within the one year period that immediately follows the purchase date, Yamaha will, subject to the terms of this warranty, supply these parts without charge. However, charges for labor, and/or any miscellaneous expenses incurred are the consumers responsibility. Yamaha reserves the right to utilize reconditioned parts in repairing these products and/or to use reconditioned units as warranty replacements.

THIS WARRANTY IS THE ONLY EXPRESS WARRANTY WHICH YAMAHA MAKES IN CONNECTION WITH THESE PRODUCTS. ANY IMPLIED WARRANTY APPLICABLE TO THE PRODUCT, INCLUDING THE WARRANTY OF MERCHANT ABILITY IS LIMITED TO THE DURATION OF THE EXPRESS WARRANTY. YAMAHA EXCLUDES AND SHALL NOT BE LIABLE IN ANY EVENT FOR INCIDENTAL OR CONSEQUENTIAL DAMAGES.

Some states do not allow limitations that relate to implied warranties and/or the exclusion of incidental or consequential damages. Therefore, these limitations and exclusions may not apply to you.

This warranty gives you specific legal rights. You may also have other rights which vary from state to state.

CONSUMERS RESPONSIBILITIES

If warranty service should be required, it is necessary that the consumer assume certain responsibilities:

1. Contact the Customer Service Department of the retailer selling the product, or any retail outlet authorized by Yamaha to sell the product for assistance. You may also contact Yamaha directly at the address provided below.
2. Deliver the unit to be serviced under warranty to: the retailer selling the product, an authorized service center, or to Yamaha with an explanation of the problem. Please be prepared to provide proof purchase date (sales receipt, credit card copy, etc.) when requesting service and/or parts under warranty.
3. Shipping and/or insurance costs are the consumers responsibility.* Units shipped for service should be packed securely.

*Repaired units will be returned PREPAID if warranty service is required within the first 90 days.

IMPORTANT: Do NOT ship anything to ANY location without prior authorization. A Return Authorization (RA) will be issued that has a tracking number assigned that will expedite the servicing of your unit and provide a tracking system if needed.

4. Your owners manual contains important safety and operating instructions. It is your responsibility to be aware of the contents of this manual and to follow all safety precautions.

EXCLUSIONS

This warranty does not apply to units whose trade name, trademark, and/or ID numbers have been altered, defaced, exchanged removed, or to failures and/or damages that may occur as a result of:

1. Neglect, abuse, abnormal strain, modification or exposure to extremes in temperature or humidity.
2. Improper repair or maintenance by any person who is not a service representative of a retail outlet authorized by Yamaha to sell the product, an authorized service center, or an authorized service representative of Yamaha.
3. This warranty is applicable only to units sold by retailers authorized by Yamaha to sell these products in the U.S.A., the District of Columbia, and Puerto Rico. This warranty is not applicable in other possessions or territories of the U.S.A. or in any other country.

Please record the model and serial number of the product you have purchased in the spaces provided below.

Model _____ Serial # _____ Sales Slip # _____

Purchased from _____ Date _____
(Retailer)

YAMAHA CORPORATION OF AMERICA
Electronic Service Division
6600 Orangethorpe Avenue
Buena Park, CA 90620

KEEP THIS DOCUMENT FOR YOUR RECORDS. DO NOT MAIL!

For details of products, please contact your nearest Yamaha representative or the authorized distributor listed below.

Pour plus de détails sur les produits, veuillez-vous adresser à Yamaha ou au distributeur le plus proche de vous figurant dans la liste suivante.

Die Einzelheiten zu Produkten sind bei Ihrer unten aufgeführten Niederlassung und bei Yamaha Vertragshändlern in den jeweiligen Bestimmungsländern erhältlich.

Para detalles sobre productos, contacte su tienda Yamaha más cercana o el distribuidor autorizado que se lista debajo.

NORTH AMERICA

CANADA

Yamaha Canada Music Ltd.
135 Milner Avenue, Scarborough, Ontario,
M1S 3R1, Canada
Tel: 416-298-1311

U.S.A.

Yamaha Corporation of America
6600 Orangethorpe Ave., Buena Park, Calif. 90620,
U.S.A.
Tel: 714-522-9011

CENTRAL & SOUTH AMERICA

MEXICO

Yamaha de México S.A. de C.V.
Calz. Javier Rojo Gómez #1149,
Col. Guadalupe del Moral
C.P. 09300, México, D.F., México
Tel: 55-5804-0600

BRAZIL

Yamaha Musical do Brasil Ltda.
Av. Reboucas 2636-Pinheiros CEP: 05402-400
Sao Paulo-SP, Brasil
Tel: 011-3085-1377

ARGENTINA

Yamaha Music Latin America, S.A.
Sucursal de Argentina
Viamonte 1145 Piso2-B 1053,
Buenos Aires, Argentina
Tel: 1-4371-7021

PANAMA AND OTHER LATIN AMERICAN COUNTRIES/ CARIBBEAN COUNTRIES

Yamaha Music Latin America, S.A.
Torre Banco General, Piso 7, Urbanización Marbella,
Calle 47 y Aquilino de la Guardia,
Ciudad de Panamá, Panamá
Tel: +507-269-5311

EUROPE

THE UNITED KINGDOM

Yamaha-Kemble Music (U.K.) Ltd.
Sherbourne Drive, Tilbrook, Milton Keynes,
MK7 8BL, England
Tel: 01908-366700

IRELAND

Danfay Ltd.
61D, Sallynoggin Road, Dun Laoghaire, Co. Dublin
Tel: 01-2859177

GERMANY

Yamaha Music Central Europe GmbH
Siemensstraße 22-34, 25462 Rellingen, Germany
Tel: 04101-3030

SWITZERLAND/LIECHTENSTEIN

**Yamaha Music Central Europe GmbH,
Branch Switzerland**
Seefeldstrasse 94, 8008 Zürich, Switzerland
Tel: 01-383 3990

AUSTRIA

**Yamaha Music Central Europe GmbH,
Branch Austria**
Schleiergasse 20, A-1100 Wien, Austria
Tel: 01-60203900

THE NETHERLANDS

**Yamaha Music Central Europe,
Branch Nederland**
Clarissenhof 5-b, 4133 AB Vianen, The Netherlands
Tel: 0347-358 040

BELGIUM/LUXEMBOURG

**Yamaha Music Central Europe GmbH,
Branch Belgium**
Rue de Geneve (Genevestraat) 10, 1140 - Brussels,
Belgium
Tel: 02-726 6032

FRANCE

Yamaha Musique France
BP 70-77312 Marne-la-Vallée Cedex 2, France
Tel: 01-64-61-4000

ITALY

Yamaha Musica Italia S.P.A.
Viale Italia 88, 20020 Lainate (Milano), Italy
Tel: 02-935-771

SPAIN/PORTUGAL

Yamaha-Hazen Música, S.A.
Ctra. de la Coruna km. 17, 200, 28230
Las Rozas (Madrid), Spain
Tel: 91-639-8888

GREECE

Philippos Nakas S.A. The Music House
147 Skiathou Street, 112-55 Athens, Greece
Tel: 01-228 2160

SWEDEN

Yamaha Scandinavia AB
J. A. Wettergrens Gata 1
Box 30053
S-400 43 Göteborg, Sweden
Tel: 031 89 34 00

DENMARK

YS Copenhagen Liaison Office
Generatorvej 8B
DK-2730 Herlev, Denmark
Tel: 44 92 49 00

FINLAND

F-Musiikki Oy
Kluuvikatu 6, P.O. Box 260,
SF-00101 Helsinki, Finland
Tel: 09 618511

NORWAY

Norsk filial av Yamaha Scandinavia AB
Grini Næringspark 1
N-1345 Østerås, Norway
Tel: 67 16 77 70

ICELAND

Skifan HF
Skeifan 17 P.O. Box 8120
IS-128 Reykjavik, Iceland
Tel: 525 5000

OTHER EUROPEAN COUNTRIES

Yamaha Music Central Europe GmbH
Siemensstraße 22-34, 25462 Rellingen, Germany
Tel: +49-4101-3030

AFRICA

**Yamaha Corporation,
Asia-Pacific Music Marketing Group**
Nakazawa-cho 10-1, Hamamatsu, Japan 430-8650
Tel: +81-53-460-2312

MIDDLE EAST

TURKEY/CYPRUS

Yamaha Music Central Europe GmbH
Siemensstraße 22-34, 25462 Rellingen, Germany
Tel: 04101-3030

OTHER COUNTRIES

Yamaha Music Gulf FZE
LB21-128 Jebel Ali Freezone
P.O.Box 17328, Dubai, U.A.E.
Tel: +971-4-881-5868

ASIA

THE PEOPLE'S REPUBLIC OF CHINA

Yamaha Music & Electronics (China) Co.,Ltd.
25/F., United Plaza, 1468 Nanjing Road (West),
Jingan, Shanghai, China
Tel: 021-6247-2211

HONG KONG

Tom Lee Music Co., Ltd.
11/F., Silvercord Tower 1, 30 Canton Road,
Tsimshatsui, Kowloon, Hong Kong
Tel: 2737-7688

INDONESIA

PT. Yamaha Music Indonesia (Distributor)
PT. Nusantara
Gedung Yamaha Music Center, Jalan Jend. Gatot
Subroto Kav. 4, Jakarta 12930, Indonesia
Tel: 21-520-2577

KOREA

Yamaha Music Korea Ltd.
Tong-Yang Securities Bldg. 16F 23-8 Yoido-dong,
Youngdungpo-ku, Seoul, Korea
Tel: 02-3770-0660

MALAYSIA

Yamaha Music Malaysia, Sdn., Bhd.
Lot 8, Jalan Perbandaran, 47301 Kelana Jaya,
Petaling Jaya, Selangor, Malaysia
Tel: 3-78030900

PHILIPPINES

Yupangco Music Corporation
339 Gil J. Puyat Avenue, P.O. Box 885 MCPO,
Makati, Metro Manila, Philippines
Tel: 819-7551

SINGAPORE

Yamaha Music Asia Pte., Ltd.
#03-11 A-Z Building
140 Paya Lebar Road, Singapore 409015
Tel: 747-4374

TAIWAN

Yamaha KHS Music Co., Ltd.
3F, #6, Sec.2, Nan Jing E. Rd. Taipei.
Taiwan 104, R.O.C.
Tel: 02-2511-8688

THAILAND

Siam Music Yamaha Co., Ltd.
891/1 Siam Motors Building, 15-16 floor
Rama 1 road, Wangmai, Pathumwan
Bangkok 10330, Thailand
Tel: 02-215-2626

OTHER ASIAN COUNTRIES

**Yamaha Corporation,
Asia-Pacific Music Marketing Group**
Nakazawa-cho 10-1, Hamamatsu, Japan 430-8650
Tel: +81-53-460-2317

OCEANIA

AUSTRALIA

Yamaha Music Australia Pty. Ltd.
Level 1, 99 Queensbridge Street, Southbank,
Victoria 3006, Australia
Tel: 3-9693-5111

NEW ZEALAND

Music Houses of N.Z. Ltd.
146/148 Captain Springs Road, Te Papapa,
Auckland, New Zealand
Tel: 9-634-0099

COUNTRIES AND TRUST TERRITORIES IN PACIFIC OCEAN

**Yamaha Corporation,
Asia-Pacific Music Marketing Group**
Nakazawa-cho 10-1, Hamamatsu, Japan 430-8650
Tel: +81-53-460-2312



Yamaha PK CLUB (Portable Keyboard Home Page, English Only)

<http://www.yamahaPKclub.com/>

Yamaha Manual Library

<http://www2.yamaha.co.jp/manual/english/>

U.R.G., Pro Audio & Digital Musical Instrument Division, Yamaha Corporation
© 2004 Yamaha Corporation

WC34830 ???PO???.?-01A0 Printed in China