



Network CD Receiver

CRX-N470

CRX-N470D

OWNER'S MANUAL



IMPORTANT SAFETY INSTRUCTIONS

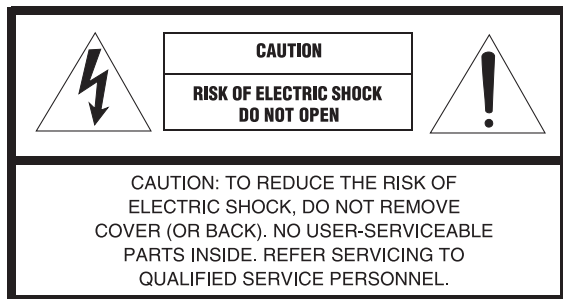

• Explanation of Graphical Symbols



The lightning flash with arrowhead symbol, within an equilateral triangle, is intended to alert you to the presence of uninsulated “dangerous voltage” within the product’s enclosure that may be of sufficient magnitude to constitute a risk of electric shock to persons.



The exclamation point within an equilateral triangle is intended to alert you to the presence of important operating and maintenance (servicing) instructions in the literature accompanying the appliance.

- 1 Read these instructions.
- 2 Keep these instructions.
- 3 Heed all warnings.
- 4 Follow all instructions.
- 5 Do not use this apparatus near water.
- 6 Clean only with dry cloth.
- 7 Do not block any ventilation openings. Install in accordance with the manufacturer’s instructions.
- 8 Do not install near any heat sources such as radiators, heat registers, stoves, or other apparatus (including amplifiers) that produce heat.
- 9 Do not defeat the safety purpose of the polarized or grounding-type plug. A polarized plug has two blades with one wider than the other. A grounding type plug has two blades and a third grounding prong. The wide blade or the third prong are provided for your safety. If the provided plug does not fit into your outlet, consult an electrician for replacement of the obsolete outlet.
- 10 Protect the power cord from being walked on or pinched particularly at plugs, convenience receptacles, and the point where they exit from the apparatus.
- 11 Only use attachments/accessories specified by the manufacturer.

- 12 Use only with the cart, stand, tripod, bracket, or table specified by the manufacturer, or sold with the apparatus. When a cart is used, use caution when moving the cart/apparatus combination to avoid injury from tip-over.
- 13 Unplug this apparatus during lightning storms or when unused for long periods of time.
- 14 Refer all servicing to qualified service personnel. Servicing is required when the apparatus has been damaged in any way, such as power-supply cord or plug is damaged, liquid has been spilled or objects have fallen into the apparatus, the apparatus has been exposed to rain or moisture, does not operate normally, or has been dropped.



We Want You Listening For A Lifetime



Yamaha and the Electronic Industries Association’s Consumer Electronics Group want you to get the most out of your equipment by playing it at a safe level. One that lets the sound come through loud and clear without annoying blaring or distortion – and, most importantly, without affecting your sensitive hearing.

Since hearing damage from loud sounds is often undetectable until it is too late, Yamaha and the Electronic Industries Association’s Consumer Electronics Group recommend you to avoid prolonged exposure from excessive volume levels.

FCC INFORMATION (for US customers)

1 IMPORTANT NOTICE: DO NOT MODIFY THIS UNIT!

This product, when installed as indicated in the instructions contained in this manual, meets FCC requirements. Modifications not expressly approved by Yamaha may void your authority, granted by the FCC, to use the product.

2 IMPORTANT:

When connecting this product to accessories and/or another product use only high quality shielded cables. Cable/s supplied with this product MUST be used. Follow all installation instructions. Failure to follow instructions could void your FCC authorization to use this product in the USA.

3 NOTE:

This product has been tested and found to comply with the requirements listed in FCC Regulations, Part 15 for Class "B" digital devices. Compliance with these requirements provides a reasonable level of assurance that your use of this product in a residential environment will not result in harmful interference with other electronic devices. This equipment generates/uses radio frequencies and, if not installed and used according to the instructions found in the users manual, may cause interference harmful to the operation of other electronic devices.

Compliance with FCC regulations does not guarantee that interference will not occur in all installations. If this product is found to be the source of interference, which can be determined by turning the unit "OFF" and "ON", please try to eliminate the problem by using one of the following measures: Relocate either this product or the device that is being affected by the interference. Utilize power outlets that are on different branch (circuit breaker or fuse) circuits or install AC line filter/s. In the case of radio or TV interference, relocate/reorient the antenna. If the antenna lead-in is 300 ohm ribbon lead, change the lead-in to coaxial type cable. If these corrective measures do not produce satisfactory results, please contact the local retailer authorized to distribute this type of product. If you can not locate the appropriate retailer, please contact Yamaha Corporation of America A/V Division, 6600 Orangethorpe Avenue, Buena Park, CA 90620. The above statements apply ONLY to those products distributed by Yamaha Corporation of America or its subsidiaries.

FCC CAUTION

Change or modifications not expressly approved by the party responsible for compliance could void the user's authority to operate the equipment.

FOR CANADIAN CUSTOMERS

To prevent electric shock, match wide blade of plug to wide slot and fully insert.
CAN ICE-3 (B)/NMB-3 (B)

IMPORTANT

Please record the serial number of this unit in the space below.

MODEL:

Serial No.:

The serial number is located on the rear of the unit. Retain the Owner's Manual in a safe place for future reference.

COMPLIANCE INFORMATION STATEMENT

Responsible Party: Yamaha Corporation of America A/V Division

Address: 6600 Orangethorpe Avenue, Buena Park, CA 90620

Telephone: 714-522-9011

Type of Equipment: Network CD Receiver

Model Name: CRX-N470

This device complies with part 15 of FCC Rules and Industry Canada's licence-exempt RSSs.

Operation is subject to the following two conditions: (1) this device may not cause harmful interference, and (2) this device must accept any interference received, including interference that may cause undesired operation.

NOTICE

This equipment has been tested and found to comply with the limits for a Class B digital device, pursuant to part 15 of the FCC Rules. These limits are designed to provide reasonable protection against harmful interference in a residential installation.

This equipment generates, uses and can radiate radio frequency energy and, if not installed and used in accordance with the instructions, may cause harmful interference to radio communications. However, there is no guarantee that interference will not occur in a particular installation. If this equipment does cause harmful interference to radio or television reception, which can be determined by turning the equipment off and on, the user is encouraged to try to correct the interference by one or more of the following measures:

- Reorient or relocate the receiving antenna.
- Increase the separation between the equipment and receiver.
- Connect the equipment into an outlet on a circuit different from that to which the receiver is connected.
- Consult the dealer or an experienced radio/TV technician for help.

This equipment complies with FCC/IC radiation exposure limits set forth for an uncontrolled environment and meets the FCC radio frequency (RF) Exposure Guidelines and RSS-102 of the IC radio frequency (RF) Exposure rules. This equipment should be installed and operated keeping the radiator at least 20cm or more away from person's body.

This transmitter must not be co-located or operated in conjunction with any other antenna or transmitter.

The FDA-related label is located on the bottom of the unit.

CAUTION: READ THIS BEFORE OPERATING YOUR UNIT.

- 1 To assure the finest performance, please read this manual carefully. Keep it in a safe place for future reference.
- 2 Install this sound system in a well ventilated, cool, dry, clean place - away from direct sunlight, heat sources, vibration, dust, moisture, and/or cold. For proper ventilation, allow the following minimum clearances.
Top: 10 cm (4 in), Rear: 6 cm (2.5 in), Sides: 6 cm (2.5 in)
- 3 Locate this unit away from other electrical appliances, motors, or transformers to avoid humming sounds.
- 4 Do not expose this unit to sudden temperature changes from cold to hot, and do not locate this unit in an environment with high humidity (i.e. a room with a humidifier) to prevent condensation inside this unit, which may cause an electrical shock, fire, damage to this unit, and/or personal injury.
- 5 Avoid installing this unit where foreign object may fall onto this unit and/or this unit may be exposed to liquid dripping or splashing. On the top of this unit, do not place:
 - Other components, as they may cause damage and/or discoloration on the surface of this unit.
 - Burning objects (i.e. candles), as they may cause fire, damage to this unit, and/or personal injury.
 - Containers with liquid in them, as they may fall and liquid may cause electrical shock to the user and/or damage to this unit.
- 6 Do not cover this unit with a newspaper, tablecloth, curtain, etc. in order not to obstruct heat radiation. If the temperature inside this unit rises, it may cause fire, damage to this unit, and/or personal injury.
- 7 Do not plug in this unit to a wall outlet until all connections are complete.
- 8 Do not operate this unit upside-down. It may overheat, possibly causing damage.
- 9 Do not use force on switches, knobs and/or cords.
- 10 When disconnecting the power cable from the wall outlet, grasp the plug; do not pull the cable.
- 11 Do not clean this unit with chemical solvents; this might damage the finish. Use a clean, dry cloth.
- 12 Only voltage specified on this unit must be used. Using this unit with a higher voltage than specified is dangerous and may cause fire, damage to this unit, and/or personal injury. Yamaha will not be held responsible for any damage resulting from use of this unit with a voltage other than specified.
- 13 To prevent damage by lightning, keep the power cable and outdoor antennas disconnected from a wall outlet or this unit during a lightning storm.
- 14 Do not attempt to modify or fix this unit. Contact qualified Yamaha service personnel when any service is needed. The cabinet should never be opened for any reasons.
- 15 When not planning to use this unit for long periods of time (i.e. vacation), disconnect the AC power plug from the wall outlet.
- 16 Be sure to refer to the “Troubleshooting” section for common operating errors before concluding that this unit is faulty.
- 17 Before moving this unit, press ϕ to set it to standby mode and disconnect the AC power plug from the wall outlet.

- 18 Condensation will form when the surrounding temperature changes suddenly. Disconnect the power cable from the outlet, then leave this unit alone.
- 19 When using this unit for a long time, this unit may become warm. Turn the power off, then leave this unit alone for cooling.
- 20 Install this unit near the AC outlet and where the AC power plug can be reached easily.
- 21 The batteries shall not be exposed to excessive heat such as sunshine, fire or the like. When you dispose of batteries, follow your regional regulations.
- 22 Excessive sound pressure from earphones and headphones can cause hearing loss.

WARNING

TO REDUCE THE RISK OF FIRE OR ELECTRIC SHOCK, DO NOT EXPOSE THIS UNIT TO RAIN OR MOISTURE.

This unit is not disconnected from the AC power source as long as it is connected to the wall outlet, even if this unit itself is turned off by ϕ . This state is called the standby mode. In this state, this unit is designed to consume a very small quantity of power.

Radio waves may affect electro-medical devices. Do not use this unit near medical devices or inside medical facilities.

Do not use this unit within 22 cm (9 inches) of persons with a heart pacemaker implant or defibrillator implant.

■ Notes on remote controls and batteries

- Do not spill water or other liquids on the remote control.
- Do not drop the remote control.
- Do not leave or store the remote control in the following conditions:
 - places of high humidity, such as near a bath
 - places of high temperatures, such as near a heater or stove
 - places of extremely low temperatures
 - dusty places
- Insert the battery according to the polarity markings (+ and -).
- Change all batteries if you notice the following condition:
 - the operation range of the remote control narrows
- If the batteries run out, immediately remove them from the remote control to prevent an explosion or acid leak.
- If you find leaking batteries, discard the batteries immediately, taking care not to touch the leaked material. If the leaked material comes into contact with your skin or gets into your eyes or mouth, rinse it away immediately and consult a doctor. Clean the battery compartment thoroughly before installing new batteries.
- Do not use old batteries together with new ones. This may shorten the life of the new batteries or cause old batteries to leak.

- Do not use different types of batteries (such as alkaline and manganese batteries) together. Specification of batteries may be different even though they look the same. Danger of explosion may happen if batteries are incorrectly replaced.
- Before inserting new batteries, wipe the compartment clean.
- Dispose of batteries according to your regional regulations.
- Keep batteries away from children. If a battery is accidentally swallowed, contact your doctor immediately.
- When not planning to use the remote control for long periods of time, remove the batteries from the remote control.
- Do not charge or disassemble the supplied batteries.

The user shall not reverse engineer, decompile, alter, translate or disassemble the software used in this unit, whether in part or in whole. For corporate users, employees of the corporation itself as well as its business partners shall observe the contractual bans stipulated within this clause. If the stipulations of this clause and this contract cannot be observed, the user shall immediately discontinue using the software.

LASER SAFETY

This unit employs a laser. Due to possible eye injury, only a qualified service person should remove the cover or attempt to service this device.

DANGER

This unit emits visible laser radiation when open. Avoid direct eye exposure to beam. When this unit is plugged into the wall outlet, do not place your eyes close to the opening of the disc tray and other openings to look into inside.

CAUTION

Use of controls or adjustments or performance of procedures other than those specified herein may result in hazardous radiation exposure.

The laser component in this product is capable of emitting radiation exceeding the limit for Class 1.

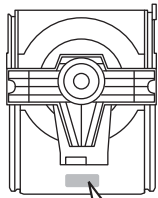

CAUTION: INVISIBLE LASER RADIATION WHEN OPEN.
DO NOT STARE INTO BEAM.
DANGER: INVISIBLE LASER RADIATION WHEN OPEN.
AVOID DIRECT EXPOSURE TO THE BEAM.

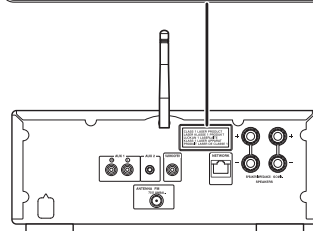

■ For U.K. customers

If the socket outlets in the home are not suitable for the plug supplied with this appliance, it should be cut off and an appropriate 3 pin plug fitted. For details, refer to the instructions described below.

Note

The plug severed from the mains lead must be destroyed, as a plug with bared flexible cord is hazardous if engaged in a live socket outlet.

■ Special Instructions for U.K. Model

IMPORTANT

THE WIRES IN MAINS LEAD ARE COLOURED IN ACCORDANCE WITH THE FOLLOWING CODE:

Blue: NEUTRAL

Brown: LIVE

As the colours of the wires in the mains lead of this apparatus may not correspond with the coloured markings identifying the terminals in your plug, proceed as follows: The wire which is coloured BLUE must be connected to the terminal which is marked with the letter N or coloured BLACK. The wire which is coloured BROWN must be connected to the terminal which is marked with the letter L or coloured RED. Making sure that neither core is connected to the earth terminal of the three pin plug.

Information for users on collection and disposal of old equipment and used batteries:



These symbols on the products, packaging, and/or accompanying documents mean that used electrical and electronic products and batteries should not be mixed with general household waste.

For proper treatment, recovery and recycling of old products and used batteries, please take them to applicable collection points, in accordance with your national legislation.

By disposing of these products and batteries correctly, you will help to save valuable resources and prevent any potential negative effects on human health and the environment which could otherwise arise from inappropriate waste handling.



For more information about collection and recycling of old products and batteries, please contact your local municipality, your waste disposal service or the point of sale where you purchased the items.



Information on Disposal in other Countries outside the European Union:

These symbols are only valid in the European Union. If you wish to discard these items, please contact your local authorities or dealer and ask for the correct method of disposal.

Pb

Note for the battery symbol (bottom two symbol examples):

This symbol might be used in combination with a chemical symbol. In this case it complies with the requirement set by the EU Battery Directive for the chemical involved.

Handling USB devices

- Yamaha is not liable for any loss or corruption of data in USB devices that are used. It is recommended that you make backups of data for restoring in the event of data loss.
- Some USB devices may not function properly.

Handling Bluetooth communications

- The 2.4 GHz band used by Bluetooth compatible devices is a radio band shared by many types of equipment. While Bluetooth compatible devices use a technology minimizing the influence of other components using the same radio band, such influence may reduce the speed or distance of communications and in some cases interrupt communications.
- The speed of signal transfer and the distance at which communication is possible differs according to the distance between the communicating devices, the presence of obstacles, radio wave conditions and the type of equipment.
- Yamaha does not guarantee all wireless connections between this unit and devices compatible with Bluetooth function.

Bluetooth

- *Bluetooth* is a technology for wireless communication between devices within an area of about 10 meters (33 ft) employing the 2.4 GHz frequency band, a band which can be used without a license.

We, Yamaha Music Europe GmbH hereby declare that this unit is in compliance with the essential requirements and other relevant provisions of Directive 1999/5/EC.

Yamaha Music Europe GmbH

Siemensstr. 22-34 25462 Rellingen, Germany

Tel: +49-4101-303-0



Table of Contents

What you can do with this unit.....8

Introduction.....9

Accessories.....9

About this manual.....9

Part names.....10

Front panel.....10

Rear panel.....11

Front panel display.....12

Remote control.....13

Preparations.....14

Connecting speakers.....14

Connecting the antenna.....15

 Preparing to connect to a network15

Turning on the power.....16

Connecting to a network.....17

Selecting connection method.....17

Connecting using MusicCast CONTROLLER.....18

Connecting to a wireless network.....19

Connecting to a wired network.....21

Updating the firmware.....22

Listening to music.....23

Listening to CDs.....23

Playing back music on USB devices.....24

Playing back music via *Bluetooth* connection.....25

Playing back music from external devices.....27

Listening to DAB stations (CRX-N470D only).....28

Listening to FM radio stations.....31

Radio Data System (U.K. and Europe models only).....33

 Listening to the Internet radio.....34

 Playing back songs in the computer.....35

 Presetting network content.....37

 Playing back music with AirPlay.....38

Connect the unit directly with a mobile device.....39

More on playback.....40

Shuffle/Repeat playback.....40

Playback information.....41

Presetting content to FAVORITES.....42

Adjusting sound quality.....43

Using the sleep timer.....43

Option settings.....44

Troubleshooting.....46

General.....46

Network.....47

Bluetooth.....48

Disc.....49

USB devices.....49

DAB reception (CRX-N470D only).....50

FM reception.....50

Messages on the front panel display.....51

Supported devices/media and file formats.....52

Supported devices/media.....52

File format.....53

Specifications.....54

Trademarks.....55

What you can do with this unit

- This unit is a Network CD Receiver, on which you can enjoy playing back music files stored on your media servers (PC or NAS) connected to the same network, USB devices, audio content on Internet radio, FM radio, CD, AirPlay devices (iPhone/iTunes), and external devices including DVD players, by connecting the unit to your home network and audio system.
- You can select songs and operate the unit easily by using the free dedicated "MusicCast CONTROLLER" app supporting iOS/Android.

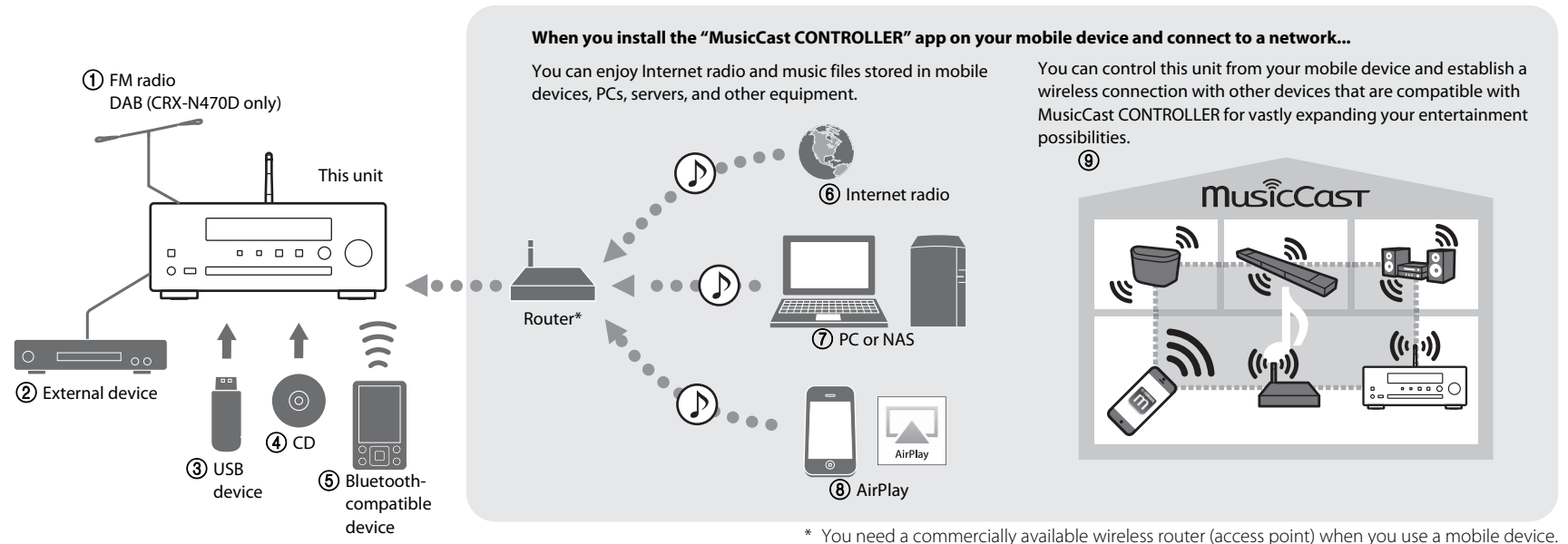

- ① Listening to FM radio stations (☞ P.31)
Listening to DAB stations (CRX-N470D only) (☞ P.28)
- ② Play back music in an external device (☞ P.27)
- ③ Play back music in a USB device (☞ P.24)
- ④ Play back a CD (☞ P.23)

- ⑤ Play back music in a *Bluetooth* compatible device (☞ P.25)
- ⑥ Play back Internet radio (☞ P.34)
- ⑦ Play back music files stored on your PC or NAS (☞ P.35)
- ⑧ Play back your iPhone with AirPlay (☞ P.38)
- ⑨ Use of MusicCast CONTROLLER (☞ P.17)

Introduction

Confirm the package contents and useful points of this manual.

Accessories

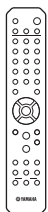

Remote control

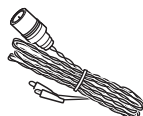

FM antenna
(for CRX-N470)

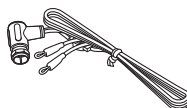

DAB/FM antenna
(for CRX-N470D)

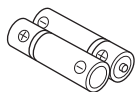

Batteries (x 2)
(AA, R6, UM-3)

About this manual

- Instructions and illustrations used in this manual refer to the CRX-N470, unless otherwise specified.
- How to operate this unit is described mainly using the remote control.
- iOS and Android mobile devices are collectively referred to as “mobile devices.” The specific type of mobile device is noted in explanations as needed.
- “iPhone” described in this manual may also refer to “iPod” or “iPad.”
- Illustrations may differ from actual item depicted.
- Symbols:

Note Indicates tips for usage and supplementary information.

 Indicates the corresponding reference page(s).

 This icon appears for features that require a network connection.

Part names

Familiarize yourself with all parts and their functions.

Front panel

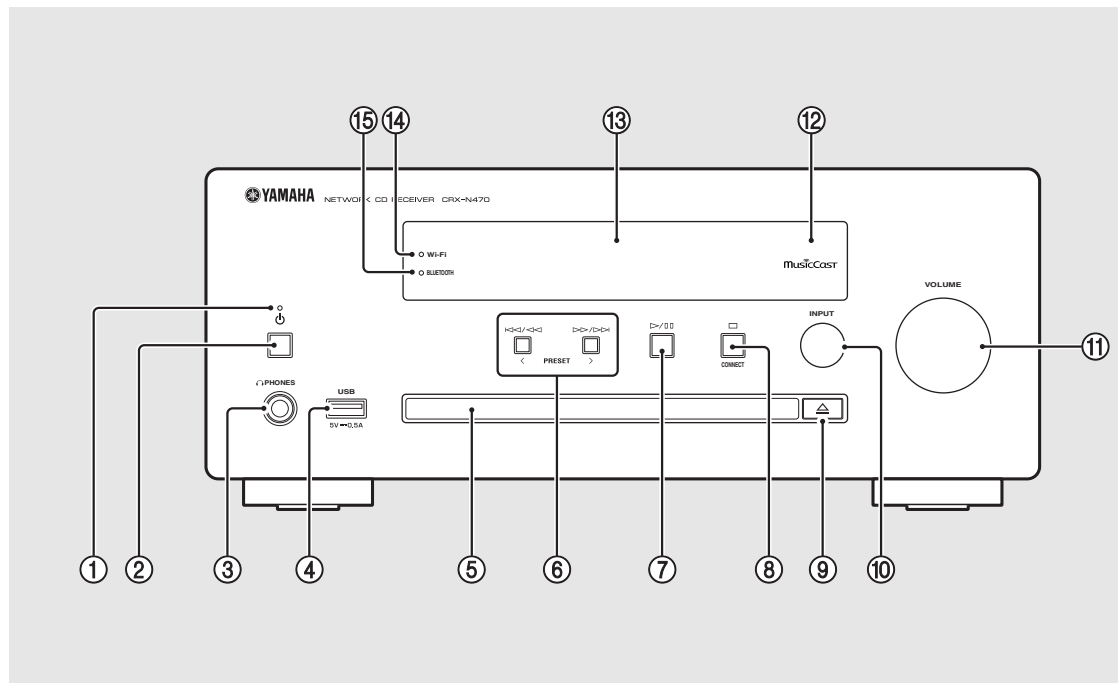

- ① **Power indicator**
Lights up when the unit is on.
- ② **⏻ (Power)** (☞ P.16)
- ③ **PHONES**
Connect headphones to this jack.
Note • When headphones are connected to it, there is no sound from the speakers or subwoofer.
- ④ **USB jack** (☞ P.24)
- ⑤ **Disc tray** (☞ P.23)
- ⑥ **⏪/⏩ ⏴/⏵** (☞ P.23, 24, 36)
PRESET </> (☞ P.32)
- ⑦ **▶/⏸ (Play/pause)** (☞ P.23, 24, 36)
- ⑧ **⏹ (Stop)** (☞ P.23, 24, 34, 36)
CONNECT (☞ P.18)
Use to connect to a network.
- ⑨ **⏴ (Open/close the disc tray)** (☞ P.23)
- ⑩ **INPUT** (☞ P.23, 24)
Change the input source. (The source is shown on the front panel display.)
- ⑪ **VOLUME**
Controls the volume.
- ⑫ **Remote control sensor**
- ⑬ **Front panel display** (☞ P.12)
- ⑭ **Wi-Fi indicator** (☞ P.19)
- ⑮ **Bluetooth indicator** (☞ P.25)

Rear panel

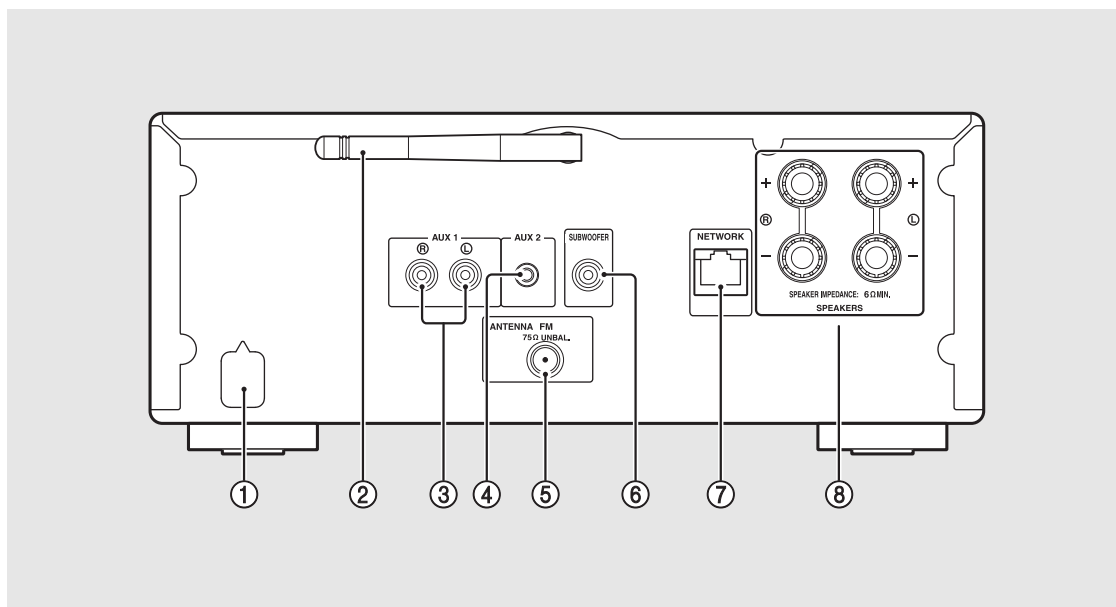

- ① Power cable (↪ P.16)
- ② Wireless antenna (↪ P.19)
- ③ AUX 1 jacks (RCA input) (↪ P.27)
- ④ AUX 2 jack (mini jack input) (↪ P.27)
- ⑤ ANTENNA jack (↪ P.15)
- ⑥ SUBWOOFER jack (↪ P.14)
- ⑦ NETWORK jack (↪ P.15)
Connects to a network using a commercially available network cable.
- ⑧ SPEAKERS terminals (↪ P.14)

Front panel display

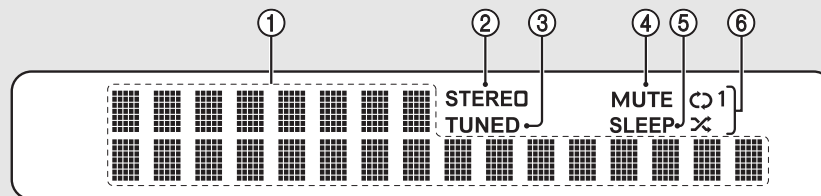

① Multi information display

Shows various information, such as music information and the radio frequency. Characters shown on the front panel display are alphanumerics only.

② STEREO indicator

Lights up when the unit is receiving a signal from an FM stereo broadcast.

③ TUNED indicator

Lights up when the unit is receiving a signal from an FM station.

④ MUTE indicator

Lights up when the sound is muted (🔇 P.13).

⑤ SLEEP indicator

Lights up when the sleep timer is set (🔔 P.43).

⑥ Shuffle/repeat indicator

Lights up when you shuffle or repeat music of your CD, USB device or computer.

Note Adjusting display brightness

You can adjust the brightness of the display by pressing the DIMMER button on the remote control (🔊 P.13).

- Each press of the button changes the brightness: bright (default), mid dim, or dim.

Remote control

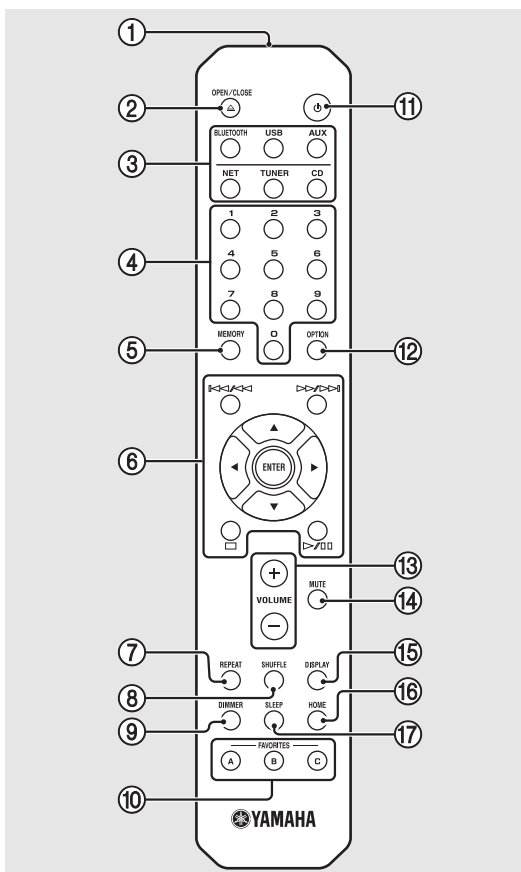

- ① Infrared signal transmitter
- ② (Open/close the disc tray) (☞ P.23)
- ③ Source buttons
Switch the input source to be played.
- ④ Numeric buttons (☞ P.23, 37)
- ⑤ MEMORY (☞ P.31, 37)
- ⑥ Audio control, cursor control buttons
(☞ P.23, 24, 34, 36)
- ⑦ REPEAT (☞ P.40)
- ⑧ SHUFFLE (☞ P.40)
- ⑨ DIMMER (☞ P.12)
- ⑩ FAVORITES (☞ P.42)
- ⑪ (Power) (☞ P.16)
- ⑫ OPTION (☞ P.44)
- ⑬ VOLUME +/-
Controls the volume.
- ⑭ MUTE
Turns mute on or off.
- ⑮ DISPLAY (☞ P.41)
- ⑯ HOME (☞ P.34, 36)
- ⑰ SLEEP (☞ P.43)

Installing batteries

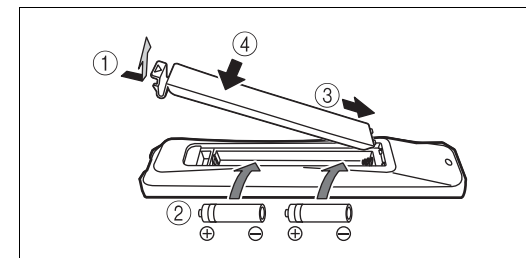

Check the "+" and "-" of the batteries and insert them facing the correct directions.

Note • Change both batteries when the operation range of the remote control decreases.

Preparations

Connect speakers, the antenna, etc. and turn the unit on.

Do not connect the power cable of the unit until you have finished connecting all cables.

Connecting speakers

- 1 Remove the insulation from the ends of the speaker cables to expose the bare wires.

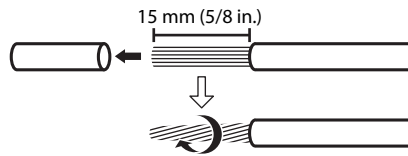

- 2 Connect speakers to the unit, as the illustration shows.

- Prepare speakers, subwoofer and speaker cables separately.
- For connection of the speakers, refer to the owner's manual supplied with them.

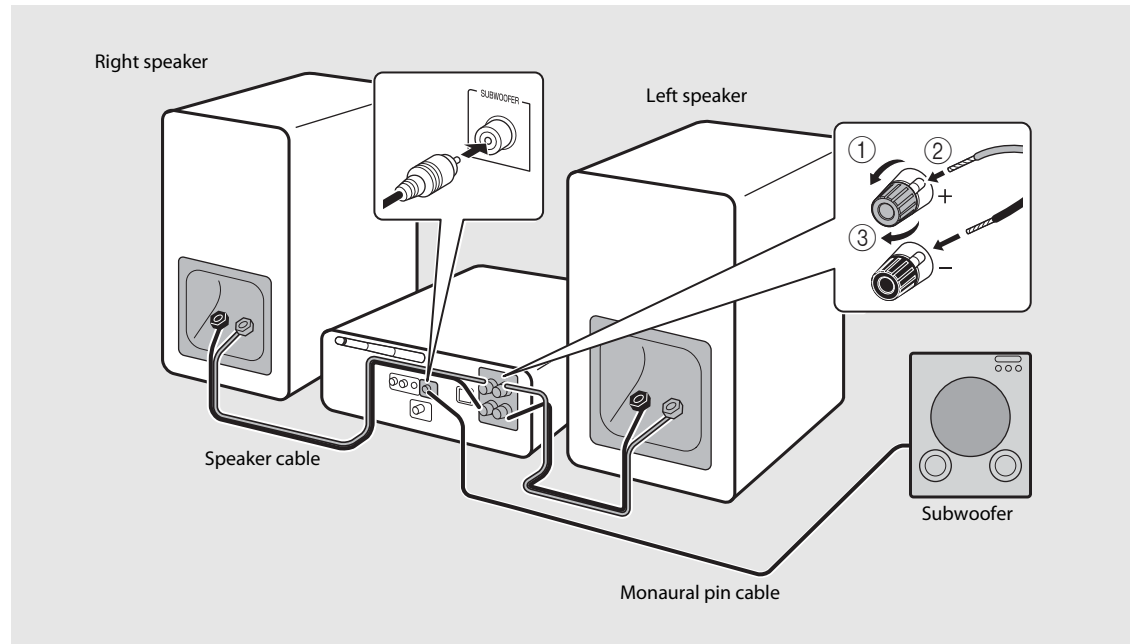

- Caution**
- If the bare speaker wires touch each other or any metal part of the unit, it could damage the unit and/or the speakers.
 - Use speakers of at least 6 Ω impedance.

- Note**
- Make sure that left and right (L, R) connections and polarity (red: +, black: -) are correct. If connections are incorrect, the sound will be unnatural.
 - You can also connect a subwoofer to the unit (it must have a built-in amplifier).

Connecting the antenna

- 1 Connect the supplied antenna to the unit.
- 2 Install it with pins where the unit can obtain good reception.

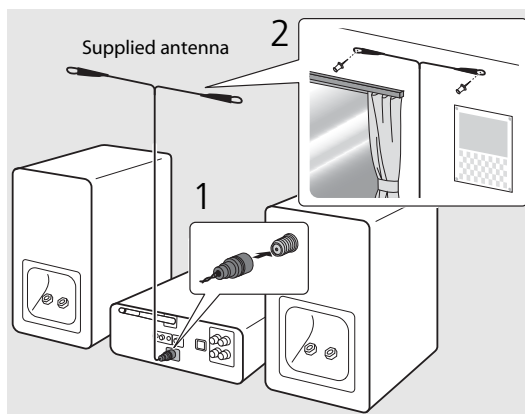

Note

- Be sure to stretch out the antenna as the illustration shows.
- If radio reception with the supplied antenna is not satisfactory, a commercially available outdoor antenna may improve reception.

Preparing to connect to a network

Connecting to a wireless network

Raise the wireless antenna.

- Raise the wireless antenna on the rear panel.

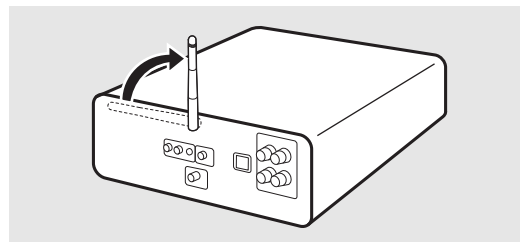

- Caution**
- Do not apply excessive force to the wireless antenna.
 - Do not remove the antenna.

Connecting to a wired network

Connect the unit to a router, as the illustration shows.

- Connect using a commercially available network cable (CAT-5 or higher straight cable).

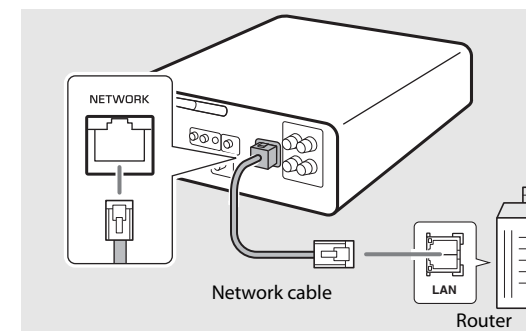

Turning on the power

Plug the power cable into a power outlet, and press .

- The unit turns on.
- Press  again to turn the unit off (standby mode).
- When the power of the unit is turned on for the first time after purchase, the network settings preparation message (Share WiFi Set) may appear. If it appears, refer to step 6 in "Sharing the settings of an iOS device" (P.20).

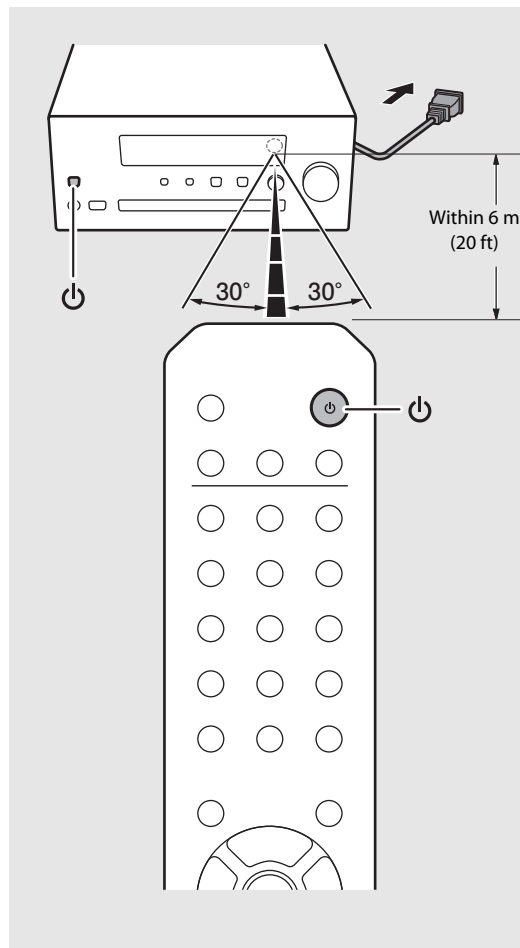

Option menu regarding power (System Config)

(Bold: default)

For details on operating the option menu, refer to "Option settings" (P.44).

AutoPowerStby

This configures whether the unit automatically enters the standby mode.

(On, Off)

When set to On, the unit automatically enters the standby mode under the following conditions according to the input source:

- Network/Bluetooth/CD/USB: When no operation or playback is performed for 20 minutes
- Other sources: When no operation is performed for 8 hours

Net Standby

This configures whether the unit performs network operations while in the standby mode.

(On, Off)

When set to Off, network operations while the unit is in standby mode are stopped, and power consumption is reduced. When Net Standby is Off, the following features cannot be used while the unit is in standby mode:

- Using the MusicCast CONTROLLER app (P.18) to turn on the unit's power
- Charging of USB devices
- AirPlay
- Bluetooth

Connecting to a network

You can play back music files stored on your PC, mobile devices, DLNA*-compatible NAS, or audio content on the Internet by connecting this unit to a network.

* Digital Living Network Alliance

Selecting connection method

Using the MusicCast CONTROLLER app is the most simple and recommended way to connect to a network.

Note

- When playing back high-resolution audio sources, it is recommended to use a wired network in order to maintain a stable connection.
- For details on Internet connection, refer to the owner's manuals of your network devices.
- Some security software installed on your PC or the firewall settings of network devices (such as a router) may block the access of the unit to the network devices or the Internet. In this case, change the setting of the security software or network devices.

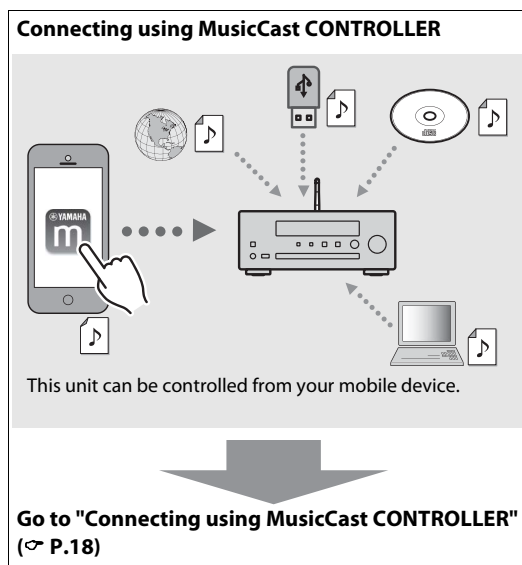

Connecting without using MusicCast CONTROLLER

Connecting to a wireless network



Go to "Connecting to a wireless network"
(☞ P.19)

Connecting to a wired network



Go to "Connecting to a wired network"
(☞ P.21)

Connecting using MusicCast CONTROLLER

Connect this unit to the same home network as your mobile devices.

1 Install the "MusicCast CONTROLLER" app on your mobile device.

- This app can be downloaded for free from the App Store or Google Play.

2 Start "MusicCast CONTROLLER" and tap "Setup".

- Follow the app's instructions.

3 Press and hold for about 5 seconds.

- The Wi-Fi indicator starts flashing. Configure the settings by following the app's instructions.

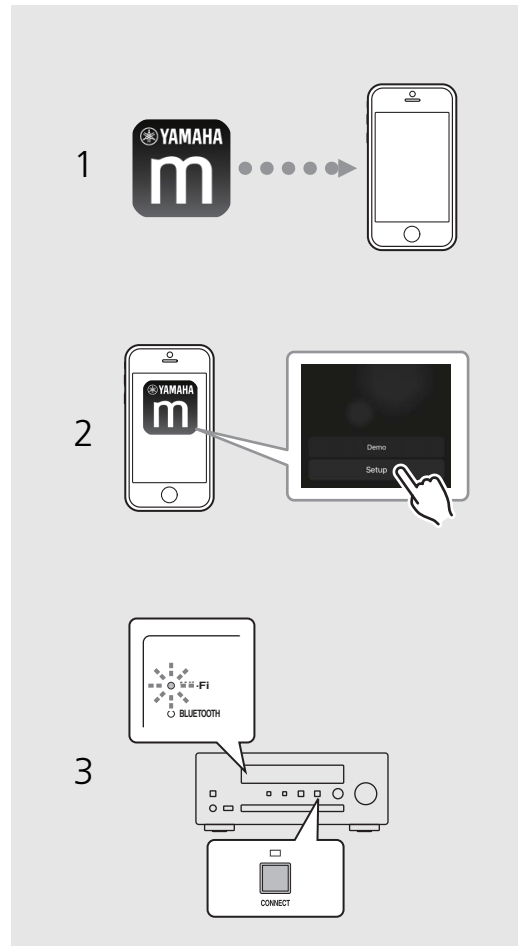

Note

- For more information about MusicCast CONTROLLER, refer to the following site: <http://www.yamaha.com/musiccast/>
- For setting up MusicCast CONTROLLER, you can also refer to the "MusicCast Setup Guide", which is available on the following site: Yamaha Downloads <http://download.yamaha.com/>

Connecting to a wireless network

Setup can be performed using a WPS (Wi-Fi Protected Setup) button, or by sharing settings from an iOS device (iPhone, etc.).

Setup using a WPS button

- A wireless router (access point) with a WPS button is required.

- 1 Press **OPTION**.
- 2 Select [Network Config] with **▲/▼**, and press **ENTER**.
- 3 Select [Select Network] with **▲/▼**, and press **ENTER**.
- 4 Select [Wireless] with **▲/▼**, and press **ENTER**.
- 5 Select [WPS] with **▲/▼**, and press **ENTER**.
- 6 Press the WPS button on the wireless router (access point).

- Once connected, the Wi-Fi indicator stays lit.

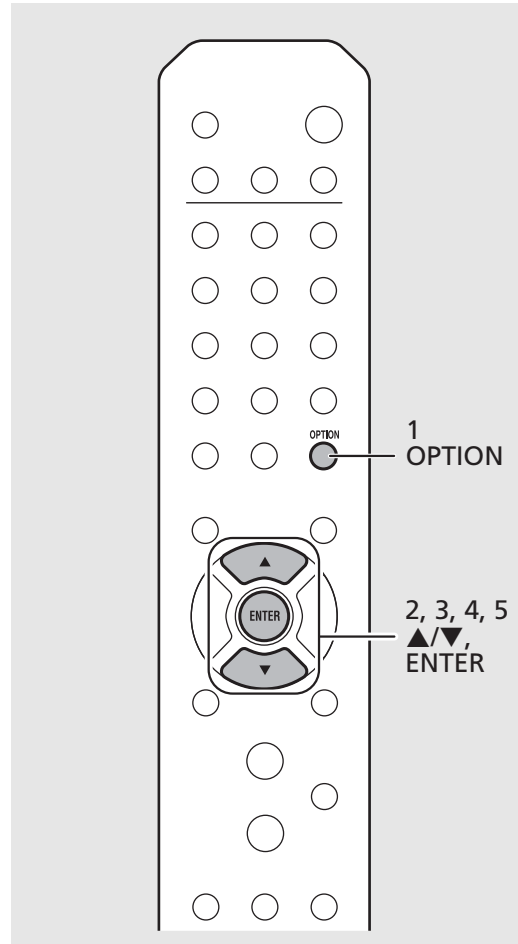

About WPS

WPS (Wi-Fi Protected Setup) is a standard established by the Wi-Fi Alliance, which allows easy establishment of a wireless home network.

Note

- You cannot simultaneously use this setting with a wired network connection or Wireless Direct (☞ P.39).
- If the unit is placed far away from the wireless router (access point), a connection may not be able to be established. In that case, place them closer together.

Sharing the settings of an iOS device

This applies the network settings of your iOS device to the unit.

- An iOS device with iOS 7.1 or later is required.
- Before starting setup, check that your iOS device is connected to the wireless router.

- 1 Press **OPTION**.
- 2 Select [Network Config] with **▲/▼**, and press **ENTER**.
- 3 Select [Select Network] with **▲/▼**, and press **ENTER**.
- 4 Select [Wireless] with **▲/▼**, and press **ENTER**.
- 5 Select [Share WiFi Set] with **▲/▼**, and press **ENTER**.
 - A message about the initialization of the network will be shown on the front panel display. Press **ENTER**.
- 6 Display the Wi-Fi setup screen on the iOS device and select the unit from "SETUP A NEW AIRPLAY SPEAKER...".
 - Follow the on-screen instructions displayed on the iOS device.
 - Once connected, the Wi-Fi indicator stays lit.

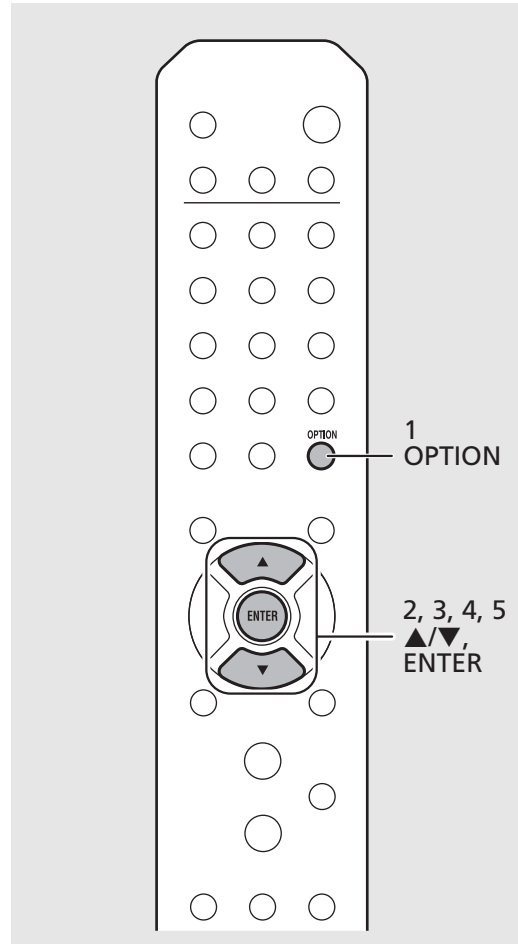

Note

- If the network settings of an iOS device are applied, all network and *Bluetooth* connection settings as well as account information for streaming services will be initialized.

Connecting to a wired network

- 1 Press **OPTION**.
- 2 Select [Network Config] with **▲/▼**, and press **ENTER**.
- 3 Select [Select Network] with **▲/▼**, and press **ENTER**.
- 4 Select [Wired] with **▲/▼**, and press **ENTER**.

- By default, [Wired] is set for the unit.

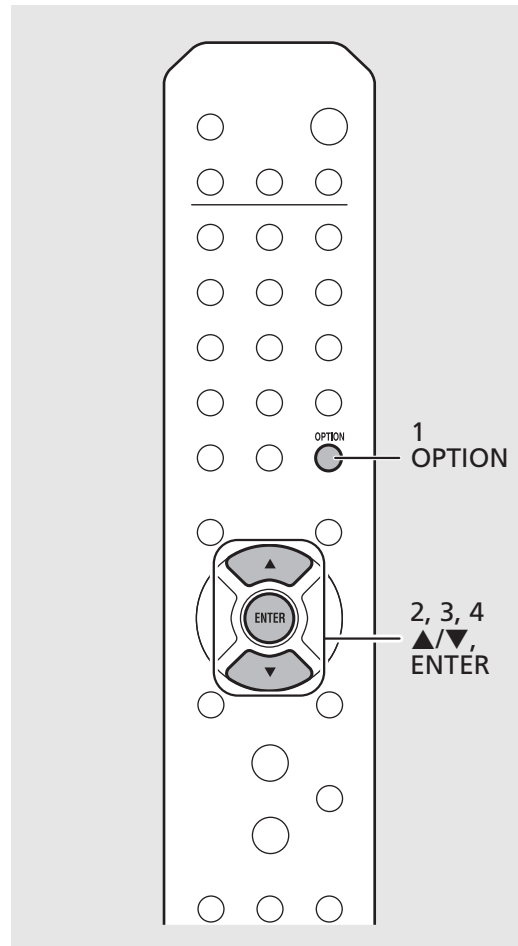











Note

- If you are using a router that does not support DHCP, configure the network settings from [Network Config] within Option settings (☞ P.44).
- When setting the subnet manually, each server must be connected to the same subnet as the unit (☞ P.45).

Updating the firmware

When a new firmware for the unit is released, a message to update your current firmware will be shown on the front panel display (when the unit is connected to the Internet only).

If this message is shown, follow the steps below to perform the update.

- 1 Press .
- 2 Select [Firmware Update] with , , and press .
- 3 Select [Update] with ,  and press .
- 4 Select [Network] with , , and press .

- Press ENTER again to begin the update.

S1-4:55%...

- When the update finishes, messages are shown in the following order: "UPDATE SUCCESS", "PLEASE ...", and "POWER OFF!"

- 5 Press  (Power) on the front panel.
 - The update is applied.

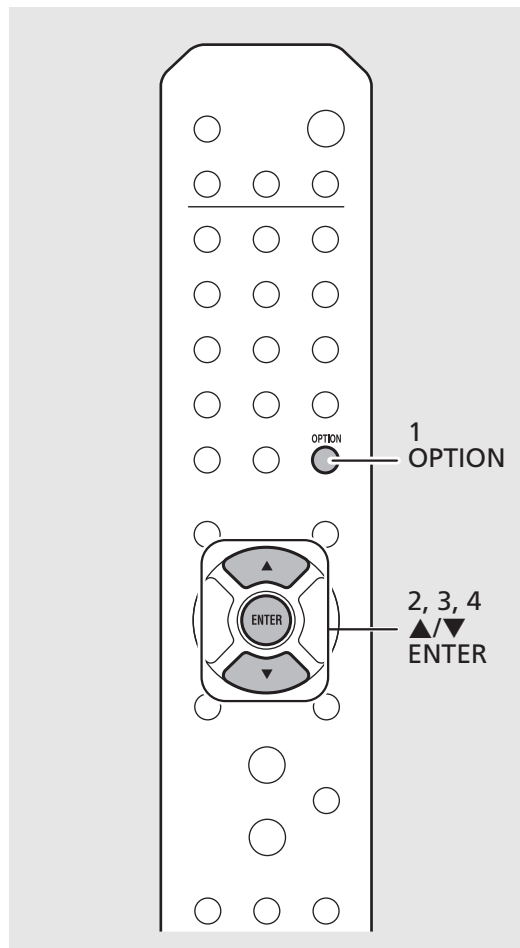

Note

- Do not operate the unit or disconnect the power cable and network cables while updating.
- When Internet speed is not fast enough or the unit is connected to the wireless network via a wireless network adapter, network update may not be possible depending on the condition of the wireless connection. In this case, try again or update the firmware using a USB memory device. The firmware can be downloaded from the Yamaha Website.



To update the firmware using a USB memory device

You can download the firmware to a USB memory device, and connect that USB memory device to the USB jack on the unit.





- Select [USB] in step 4 to start the update.

Listening to music

Listening to CDs



- 1 Press INPUT to select [CD]. Or, press  on the remote control.
- 2 Set a CD in the disc tray.
 - Press  to open/close the disc tray.
- 3 Playback starts.

The remote control functions are shown below.

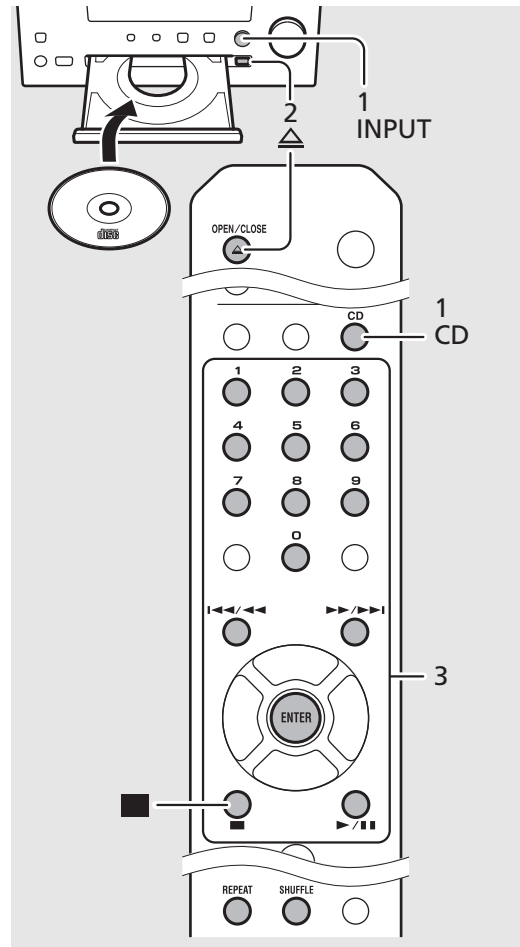
	Play/pause
	Stop
	Skip to the beginning of the song being played back, or skip to the previous song. Press and hold to fast rewind.
	Skip to the next song. Press and hold to fast forward.
SHUFFLE	Starts shuffle playback (🔗 P.40).
REPEAT	Starts repeat playback (🔗 P.40).
1 - 9, 0	Specify the song number.
ENTER	Confirmation of the song number selected with the numeric buttons.



Note



- This unit allows playback of audio CDs, and data CDs in which MP3/WMA files are recorded. For details on playable CDs, see “Supported devices/media” (🔗 P.52).
- When CD playback is stopped, playback will resume from the beginning of the song last played. Pressing  while playback is stopped will clear resume playback.
- You can cancel the song number selected with the numeric buttons by pressing .
- If you turn off the unit with CD selected as the input source and a CD set in it, the unit automatically plays back the set CD next time you turn on the unit.

▶ Playing back music on USB devices

- 1 Press INPUT to select [USB] or press  on the remote control.
- 2 Connect a USB device to the USB jack.
- 3 Browse and select a song.

	Shows other items.
ENTER/▶	Confirms the selected item and proceeds to the next level or starts playback.
HOME	Shows the top-level item.
◀	Returns to the previous item.
DISPLAY	Finishes browsing and displays information about the content being played back.

4 Playback starts.

	Play/pause
	Moves to the next or previous song in the folder.
	Stop
SHUFFLE	Starts shuffle playback (☞ P.40).
REPEAT	Starts repeat playback (☞ P.40).

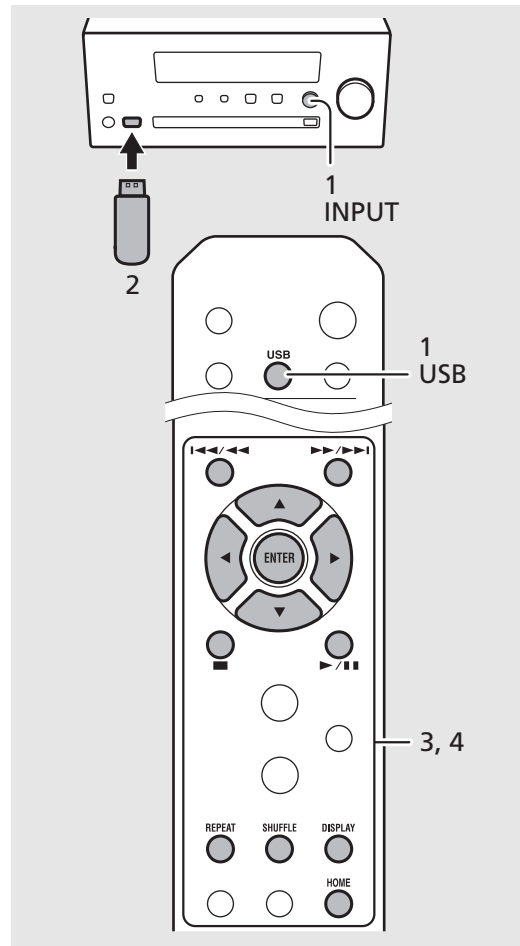

Note

- This unit allows playback from USB devices on which music files are saved. For details on playable USB devices, see “Supported devices/ media” (☞ P.52).
- Some USB devices may not work properly even if they meet the requirements. Playability of and power supply to all USB devices are not guaranteed.
- Stop playback before disconnecting the USB device.
- A USB device is automatically charged when it is connected to the unit (except when Net Standby is Off (☞ P.16)). However, some devices may not charge when connected.



- **Caution** • Yamaha and suppliers do not accept any liability for the loss of data saved on a USB device connected to the unit. As a precaution, it is recommended to make backup copies of important files.

▶ Playing back music via *Bluetooth* connection

Pairing a *Bluetooth* device and playing back music

When connecting a *Bluetooth* device to the unit for the first time, the device must be registered (paired) to the unit. After pairing has been performed once, it is easy to reconnect after the *Bluetooth* connection has been disconnected.

Set the *Bluetooth* setting of your *Bluetooth* device to ON before connecting.

- 1 Press .
- 2 Select this unit in the *Bluetooth* settings of your device.
 - The *Bluetooth* indicator lights up when a connection is established.
- 3 Play back music using your *Bluetooth* device.

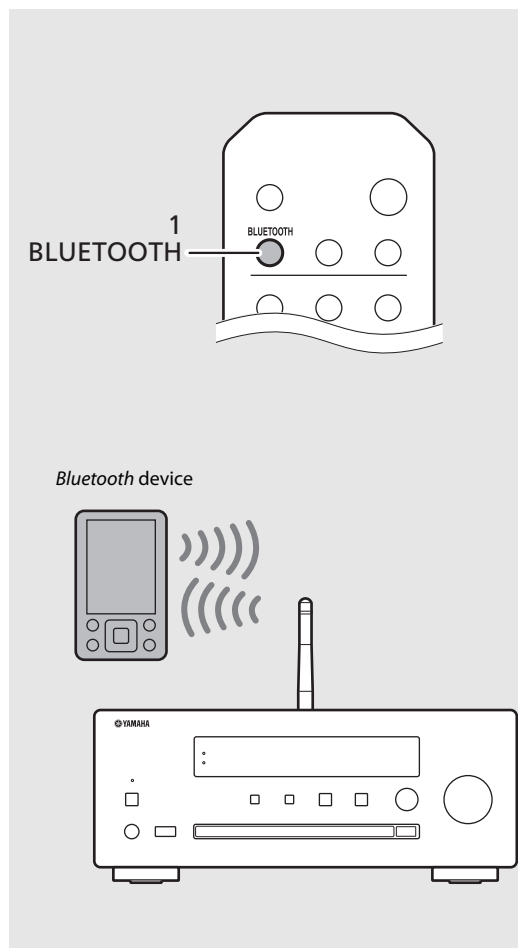

Note

- If the device does not connect to the unit automatically after the pairing is completed, select the unit again in the *Bluetooth* setting on your device.
- If pairing information for a device is deleted, you will need to perform pairing of that device again in order to connect it again.
- If another device is already connected to the unit, press and hold **BLUETOOTH** to terminate the *Bluetooth* connection, then perform pairing with the new device.
- If a passkey is required during the pairing operation, enter the number "0000."
- For details on connecting, see the owner's manual of your device.

Connecting a paired *Bluetooth* device and playing back music

If the unit is connected to another device via *Bluetooth* connection, terminate that connection (see “Terminating the *Bluetooth* connection” on the right) before connecting to the target device.

1 Perform *Bluetooth* connection.

- **Connecting from the unit:** Press **BLUETOOTH**.
- **Connecting from the *Bluetooth* device:**
Turn on the *Bluetooth* function of the *Bluetooth* device, and select the unit from the available device list.
- The *Bluetooth* indicator lights up when a connection is established.

2 Play back music using your *Bluetooth* device.

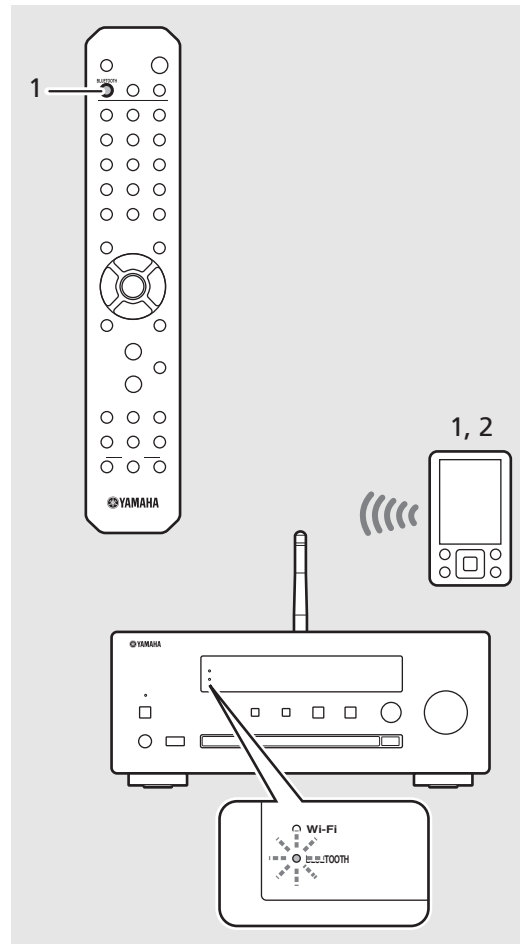

Note

- **Decrease the volume of the unit before playback.** Otherwise, playback volume may be too loud.
- If connecting from the unit, the unit searches for the *Bluetooth* device connected the last time. In this case, make sure that device's *Bluetooth* function is turned on.

Terminating the *Bluetooth* connection

- *Bluetooth* connection can be terminated by any of the following methods:
 - Terminate the *Bluetooth* connection from the connected device.
 - Change to another input source.
 - Press and hold **BLUETOOTH**.
 - Set the unit to standby mode.

▶ Playing back music from external devices

This unit allows playback from external devices, such as a DVD player.

- 1 Unplug the power cable of the unit and connect the external device to the unit.

- Prepare commercially available cables for connection.

- 2 Plug the power cable of the unit back into the wall outlet and press  to turn the unit on.

- 3 Change the input source.

- Each time AUX is pressed, the input source switches between AUX 1 and AUX 2.

- 4 Play back the connected external device.

- For details on playback, refer to the owner's manual supplied with the external device.

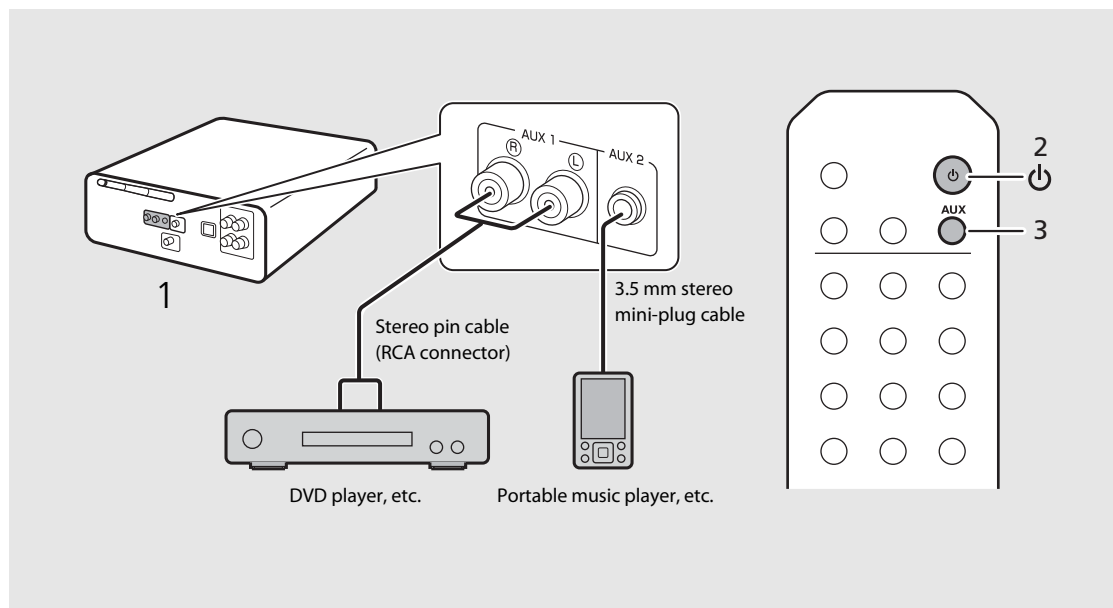

Note

- **Decrease the volume of the unit and the connected external device before connection.** Otherwise, playback volume may be too loud.
- Use the jacks (AUX 1 or AUX 2) according to the device to be connected (☞ P.11). For the connection of each external device, refer to its supplied owner's manual.

Listening to DAB stations (CRX-N470D only)

See “Connecting the antenna” (P.15) for connecting the supplied antenna to the unit.

Initial scan

Press  repeatedly to select [DAB].

- Initial scan starts automatically when you select [DAB] for the first time.
- When scanning is completed, the number of receivable DAB stations is shown on the front panel display momentarily, and the first station stored is played.

Tuning in DAB stations

1 Press  repeatedly to select [DAB].

- When the unit cannot receive the DAB signal, “Off Air” is shown on the front panel display.

2 Press  to select a DAB station.

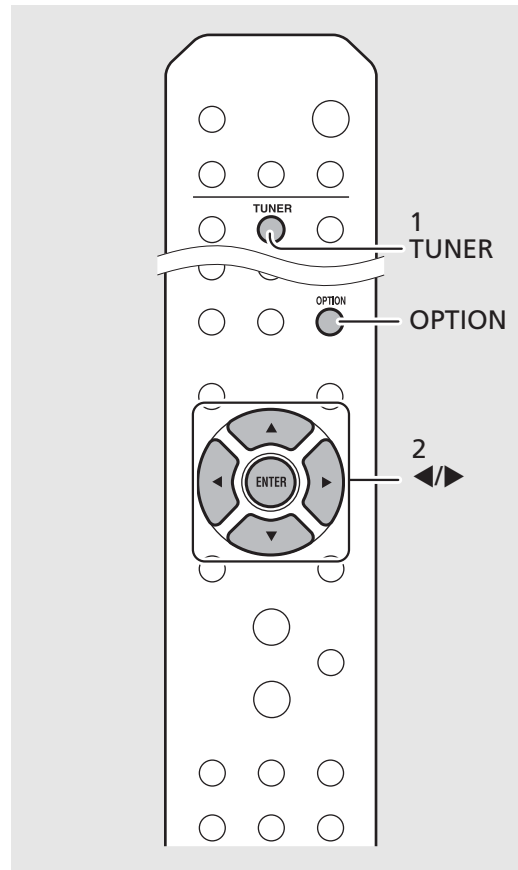



Note

- You can also perform an initial scan from the Option settings.

1 Press  when the source is DAB.

- Option menu is shown on the front panel display.

2 Press  to select [Initial Scan] and press .

- Initial scan starts and finishes automatically.
- If an initial scan is performed, stored DAB station information and preset DAB stations are cleared.
- This unit can receive only Band III DAB frequencies.

Frequency in MHz/Channel label

174.928/5A	176.640/5B	178.352/5C	180.064/5D
181.936/6A	183.648/6B	185.360/6C	187.072/6D
188.928/7A	190.640/7B	192.352/7C	194.064/7D
195.936/8A	197.648/8B	199.360/8C	201.072/8D
202.928/9A	204.640/9B	206.352/9C	208.064/9D
209.936/10A	211.648/10B	213.360/10C	215.072/10D
216.928/11A	218.640/11B	220.352/11C	222.064/11D
223.936/12A	225.648/12B	227.360/12C	229.072/12D
230.784/13A	232.496/13B	234.208/13C	235.776/13D
237.488/13E	239.200/13F		



Presetting DAB stations

Use the preset function to store your favorite 30 DAB stations.



- 1 Tune in a DAB station you want to preset (P.28) and press .

- The preset number flashes on the front panel display.



- 2 Press  to select the desired preset number.
- 3 Press  to complete presetting.

Selecting preset DAB stations

- 1 Press  repeatedly to select [DAB].
- 2 Press  to select a preset station.

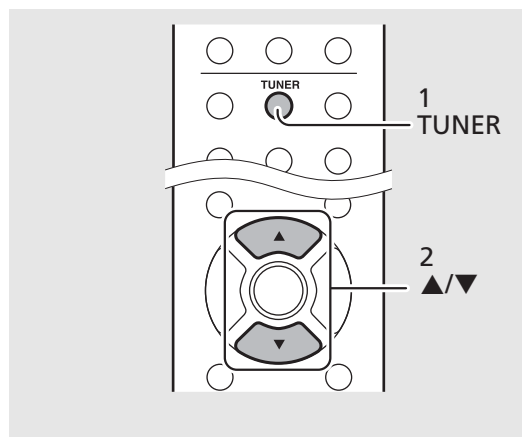
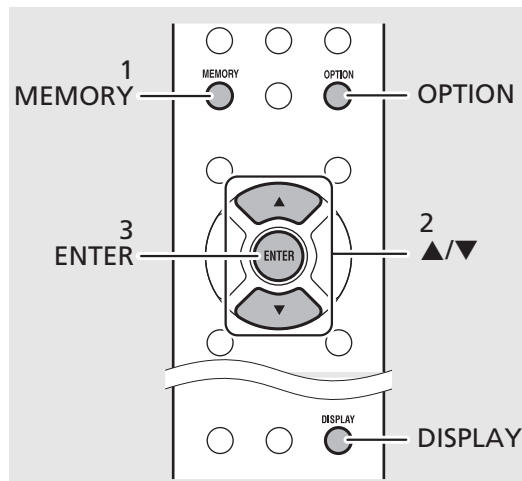

Note

- To cancel the DAB preset setting, press .
- You can change the information of the DAB station shown on the front panel display by pressing the **DISPLAY** button. The display switches in the order shown below each time you press the **DISPLAY** button.

STATION (default)

DLS (Dynamic Label Segment)

ENSEMBLE







CHANNEL/FREQ (Channel label and frequency)

SIGQ. (signal quality)

AUDIO FORMAT

Deleting a preset station

Use the Option settings to delete a preset station.

- 1 Press  when the source is DAB.
 - The Option menu is shown on the front panel display.
- 2 Press  to select [Preset Delete] and press .
- 3 Press  to select the preset number to be deleted.
- 4 Press .
 - The preset station is deleted.
- 5 Press  to exit the Option settings.

Confirming the reception

You can confirm the DAB signal level. This is useful when setting up the antenna.

- 1 Press **OPTION** when the source is [DAB].
 - Option menu is shown on the front panel display.
- 2 Press **▲/▼** to select [Tune Aid] and press **ENTER**.
- 3 Press **▲/▼** to change the channel label.
 - The measured DAB signal reception level is displayed.



Tune Aid
5A Level: 90

- The level is from 0 (none) to 100 (best).
- 4 Press **OPTION** to exit the Option settings.

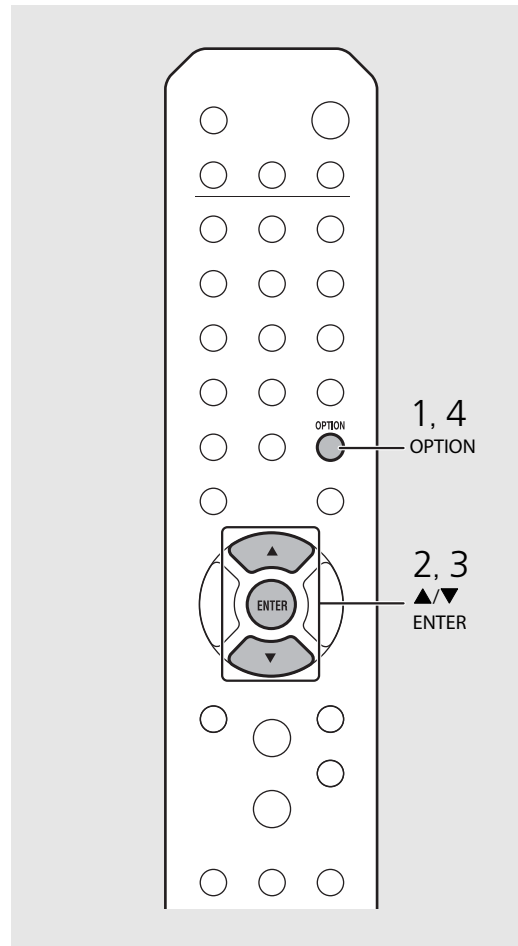



Note

- When performing Tune Aid and the DAB signal is weak, try adjusting the position of the antenna to obtain good reception.

Listening to FM radio stations

See “Connecting the antenna” (P.15) for connecting the supplied antenna to the unit.

Tuning in FM stations

- 1 Press .
- 2 Press and hold .

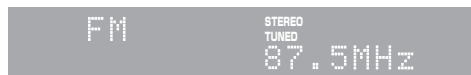

- Automatic tuning starts, then stops automatically when a station is tuned in.



Presetting FM stations

Auto preset

Tunes in stations with good reception and presets them automatically.

- 1 Press .
- 2 Press  and hold for 2 seconds or more.
- 3 Press .

- Auto preset starts, and when it finishes, “Completed!” is shown on the front panel display.

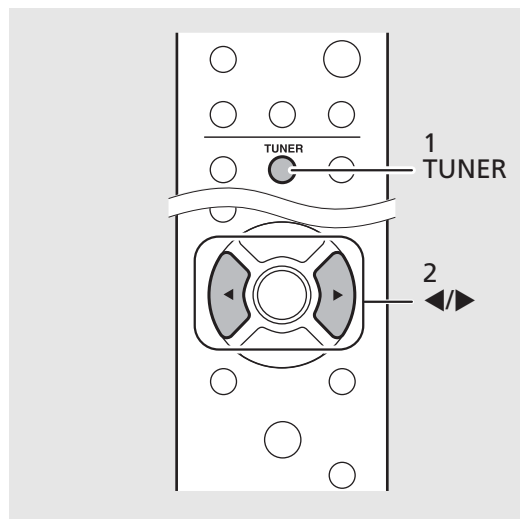

Note

- If station reception is weak, you can tune into a station manually by pressing the  button repeatedly. Playback in this case is monaural.

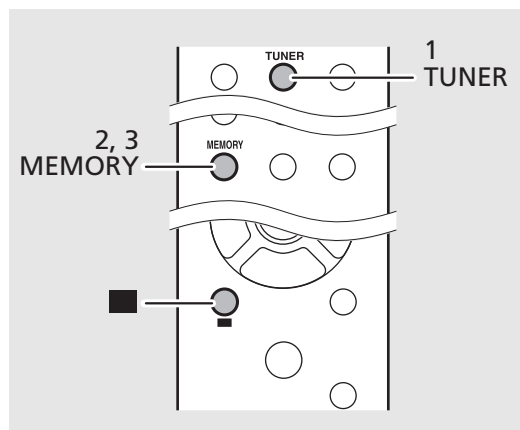

Note

- Auto preset replaces all currently-stored stations with newly-stored stations.
- You can preset up to 30 FM stations.
- To cancel the auto preset, press .
- You can also preset stations automatically from the Option menu (P.44).

Manual preset

- 1 Tune into a station you want to preset (☞ P.31).
- 2 Press **MEMORY**.
 - The preset number flashes on the front panel display.
- 3 Press **▲/▼** to select the desired preset number.
- 4 Press **ENTER** to preset the station.



Selecting preset FM stations

- 1 Press **TUNER**.
- 2 Press **▲/▼** to select a station.
 - The number of a registered preset can also be selected using the numeric buttons.

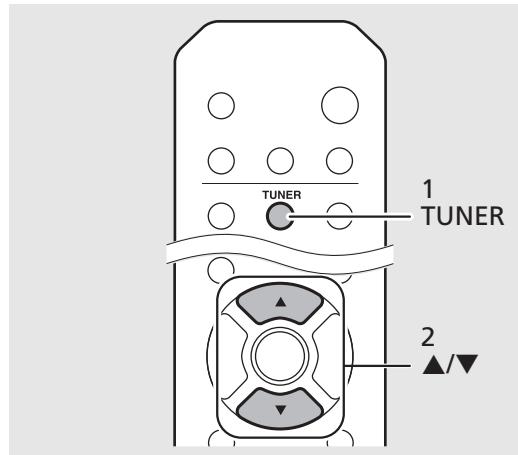
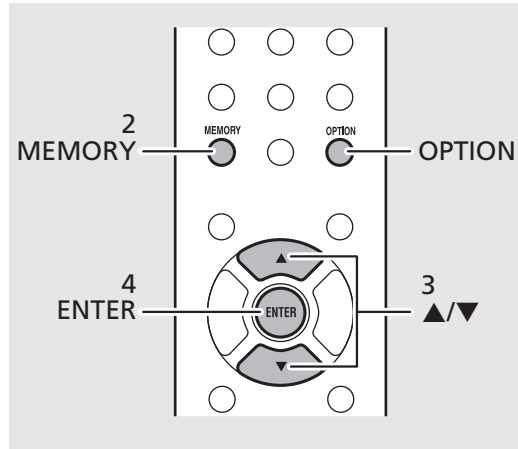

Note

- To cancel manual preset setting, press **■**.

Deleting a preset station

Use the option settings to delete a preset station.

- 1 Press **OPTION** when the source is FM.
 - The Option menu is shown on the front panel display.
 - To cancel deleting preset stations, press **OPTION**.
- 2 Press **▲/▼** to select [Preset Delete] and press **ENTER**.
- 3 Press **▲/▼** to select the preset number to be deleted.
- 4 Press **ENTER**.
 - The preset station is deleted and [Deleted!] is shown on the front panel display.
- 5 Press **OPTION** to exit the Option settings.

Radio Data System (U.K. and Europe models only)

The unit can receive Radio Data System information.

Press  when the source is FM.

- Each press of the button changes the information displays shown below.

PService (Program Service)

PTY (Program Type)

RT (Radio Text)

CT (Clock Time)

Frequency

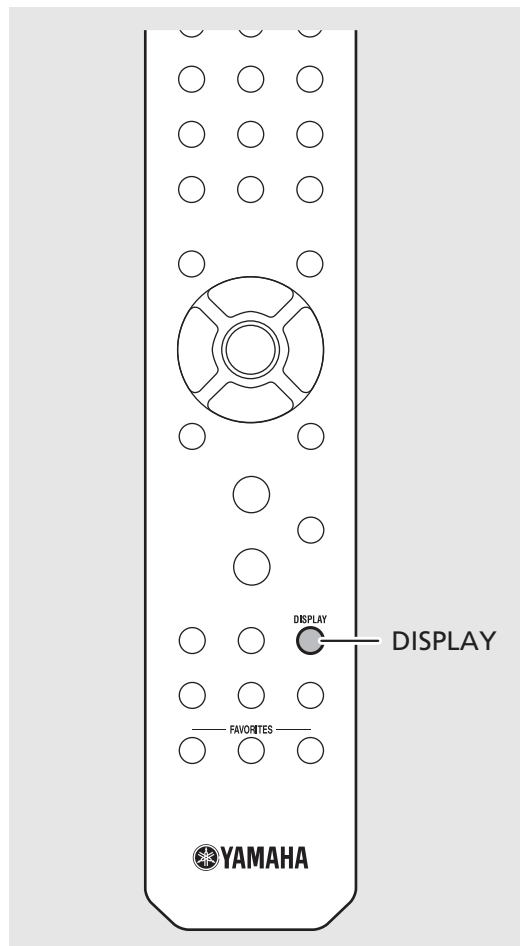

Note

- If the signal transmission of the Radio Data System station is too weak, this unit may not be able to receive Radio Data System information completely. In particular, RT (Radio Text) information uses a lot of bandwidth, so it may be less available compared to other types of information.

Listening to the Internet radio



Make sure that the unit is connected to the Internet properly (☞ P.17).

- 1 Press **NET** repeatedly and select [NetRadio].
- 2 Browse the Internet and select a radio station.



- The remote control functions are shown below.

▲/▼	Shows other items.
ENTER/▶	Confirm the selected item and proceed to the next level or start playback.
HOME	Show the top-level item.
◀	Back to the previous item.
DISPLAY	Finish browsing and display information about the content being played back.

- 3 Playback starts.

- To stop playback, press **■**.

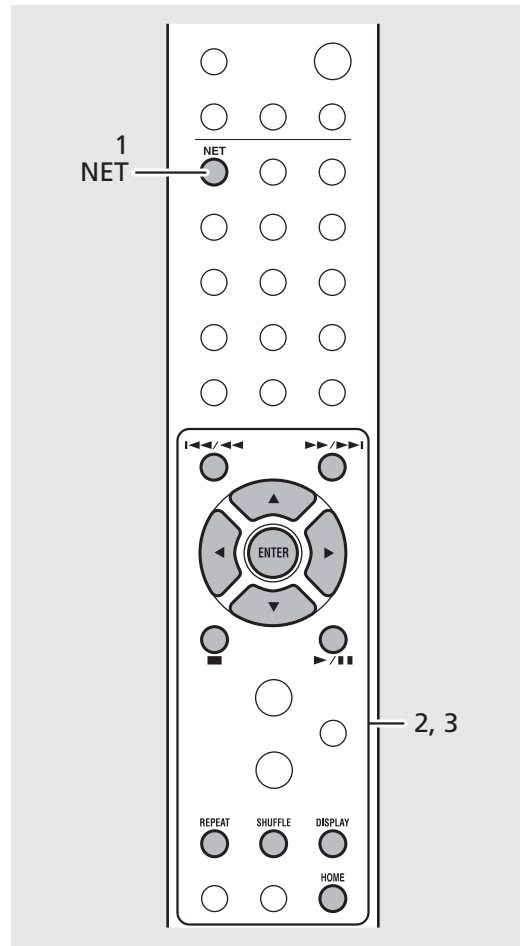

Note

- Playback information can be shown by pressing the **DISPLAY** button while Internet radio is played back, as shown below.

Radio station name (default)

Playing time

Song title

- You can register your favorite Internet radio stations to the "Bookmarks" folder by accessing the following website with the web browser on your PC.
<http://yradio.vtuner.com>
 - Before registering Internet radio stations, play back any of the Internet radio stations with the unit.
 - To use this feature, you need the vTuner ID of the unit and your e-mail address to create your personal account. You can check the vTuner ID in [Network Info] (☞ P.45) in the option settings.
- Some Internet radio stations may not be receivable during certain time periods.
- This feature makes use of the vTuner radio station database.
- This service may be canceled without prior notice.
- The stations of the Internet radio can be preset (☞ P.37).

Playing back songs in the computer



Setting the media sharing of music files

To play back music files in your computer with this unit, you need to configure the media sharing settings between the unit and computer (with Windows Media Player 11 or later).

(Example: Windows Media Player 12 (Windows 7))

- 1 Start Windows Media Player 12 on your PC.
- 2 Select "Stream," then "Turn on media streaming."

 - The control panel window of your PC is shown.

- 3 Click "Turn on media streaming."
- 4 Select "Allowed" from the drop-down list next to the unit's model name.
- 5 Click "OK" to exit.

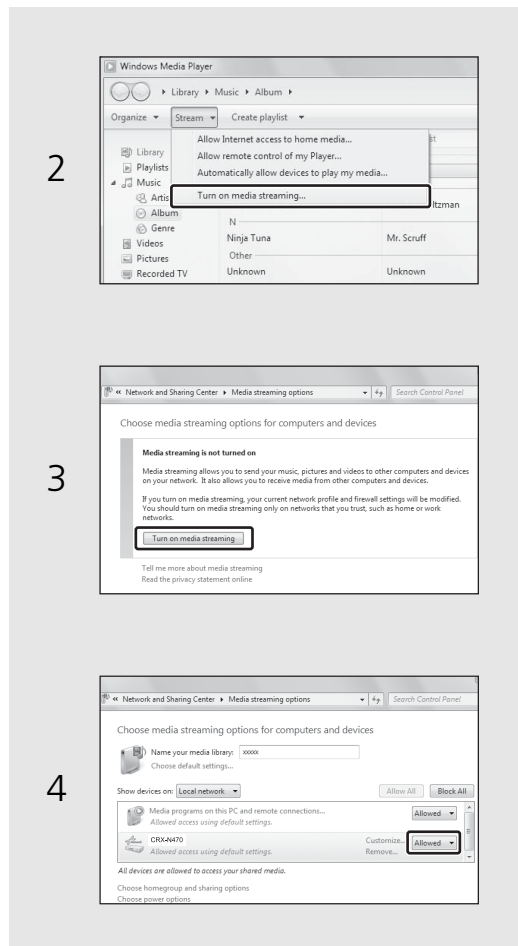

Note

- For details on the file formats that this unit can play back, refer to "File Formats" (P.53).
- For details on media sharing settings, refer to the Help of Windows Media Player.

For a PC or a NAS with other DLNA server software installed

Refer to the owner's manual of your device or software and configure the media sharing settings.



Playing back songs in the PC

1 Press  repeatedly and select [Server].

2 Browse and select a song.

	Shows other items.
ENTER/▶	Confirm the selected item and proceed to the next level or start playback.
HOME	Show the top-level item.
◀	Back to the previous item.
DISPLAY	Finish browsing and display information about the content being played back.

3 Playback starts.

	Play/pause
	Move to the next or previous song in the folder.
	Stop
SHUFFLE	Starts shuffle playback (🔗 P.40)
REPEAT	Starts repeat playback (🔗 P.40)

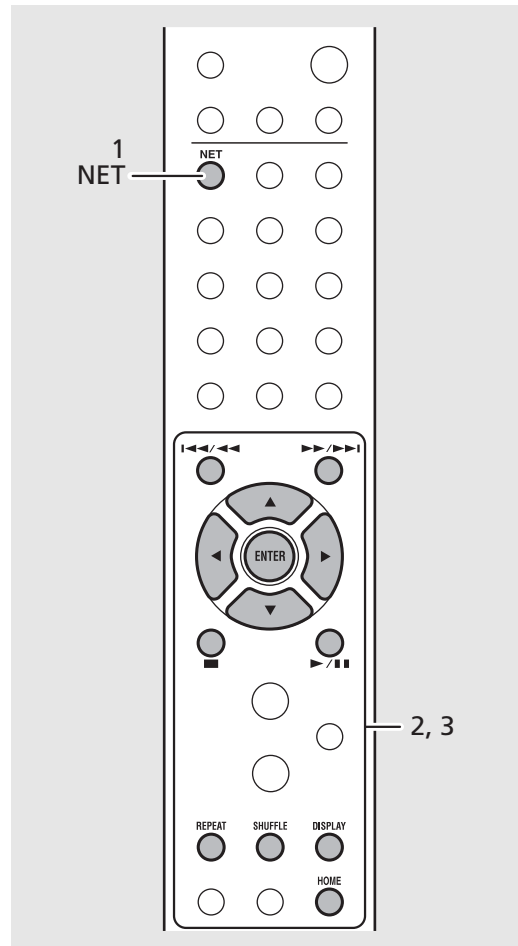

Note

- If playback is not possible, check the network connections and your router settings, and then connect the unit and the PC to the same network.
- The music files in your PC can be preset (🔗 P.37).

Presetting network content





Presetting network content allows it to be played back more easily in the future.

Presetting network content

The following types of network content can be preset:

- Internet radio
- Music files stored in a PC (server)

- 1 Press  during the playback of the network content.
- 2 Enter the desired preset number using the numeric buttons.
 - The numbers from 1 to 37 are available for presets.
- 3 Press  to preset the station.

Selecting preset network content

- 1 Press .
- 2 Enter the preset number using the numeric buttons.
 - The content that is preset for the number is played back when the unit is connected to the network.

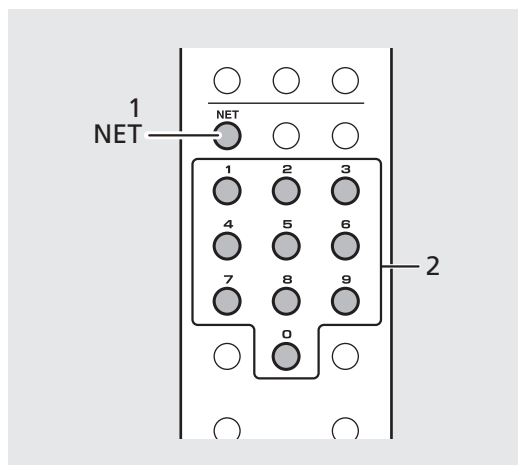
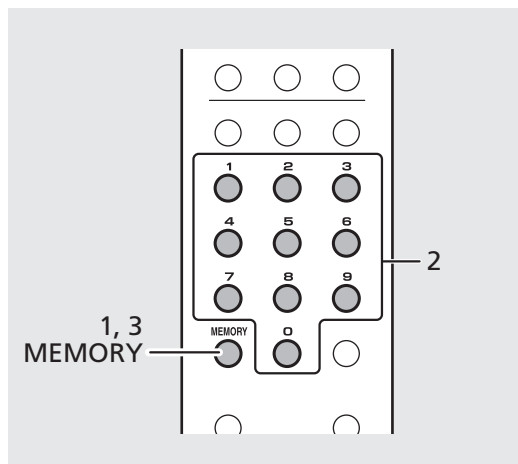

Note

- If the input preset number already has content registered, the content is overwritten.
- If  is pressed during presetting, the preset is canceled.

▶ Playing back music with AirPlay

Make sure that the unit and your PC or iPhone are connected to the same router (☞ P.17).

Playing back songs with an iPhone

- 1 Turn on the unit and display the playback screen on the iPhone.
- 2 Tap  and select the unit's name.
 - The input source switches to [AirPlay] (except when Net Standby is Off (☞ P.16)).
- 3 Play back songs with the iPhone.

Playing back songs with iTunes

- 1 Turn on the unit and start iTunes.
- 2 Click  and select the unit's name.
 - The input source switches to [AirPlay] (except when Net Standby is Off (☞ P.16)).
- 3 Play back songs with iTunes.

(Example)

When the iPhone recognizes the unit,  appears on the screen.



(Example)

When iTunes recognizes the unit,  appears on the iTunes window.

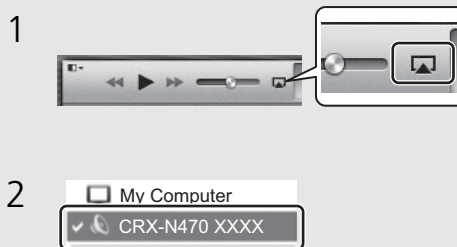

Note

- For an iPhone with iOS7/iOS8/iOS9 installed, the indication is displayed within the control center. To display the control center, swipe the iPhone screen in an upward direction.
- You can also use the unit and remote control to play back, pause, stop, and skip songs.

Canceling AirPlay

- Tap/click  on the iPhone/iTunes screen and select a device other than the unit from the speaker list. Or, change the unit's input source to something other than AirPlay.

Connect the unit directly with a mobile device

Connect the unit directly with a mobile device wirelessly (Wireless Direct). Put up the wireless antenna of the unit in advance (☞ P.15).

- 1 Press **OPTION**.
- 2 Select [Network Config] with **▲/▼**, and press **ENTER**.
- 3 Select [Select Network] with **▲/▼**, and press **ENTER**.
- 4 Select [Direct] with **▲/▼**, and press **ENTER**.
- 5 Select desired security method with **▲/▼**, and press **ENTER**.
 - Refer to the Note at right.
- 6 Check the SSID and the security key.
 - These are required for step 7.
 - You can check the values from the option menu - [Network Info] - [Direct Info].
- 7 Configure the Wi-Fi settings of the mobile device.
 - Enable the Wi-Fi function of the mobile device.
 - When the access points are listed, select the SSID you have checked in step 6.
 - When the mobile device prompts you to enter a password, enter the security key you have checked in step 6.

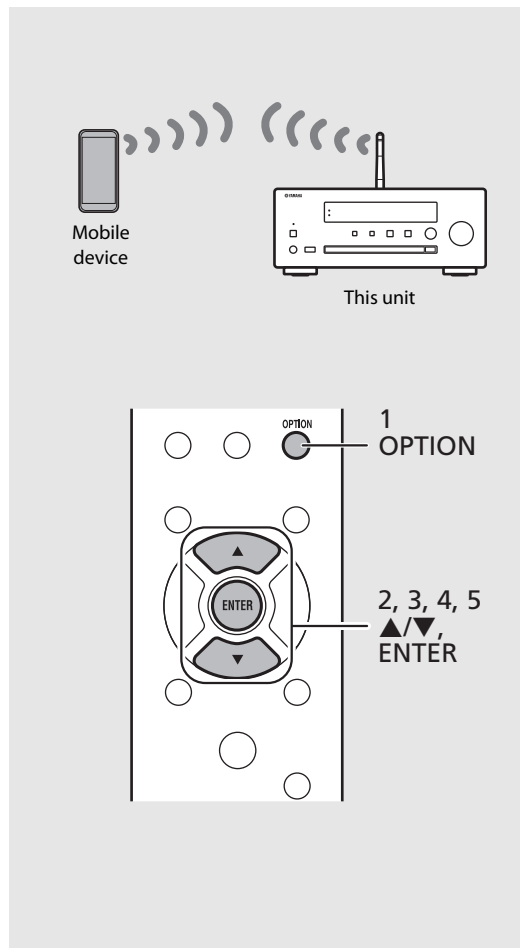

Note

- The security methods selectable in step 5 are [OPEN] and [WPA2-PSK(AES)]. If [OPEN] is selected, the connection may be insecure since the communication is not encrypted.
- You cannot simultaneously use this setting with a wired network connection or a wireless network connection.
- When using Wireless Direct, you cannot connect the unit to the Internet. Therefore, the Internet services, such as Internet radio, are unavailable.
- For details about how to set up the Wi-Fi connection of the mobile device, see the user's guide of your mobile device.

More on playback

Features such as shuffle/repeat playback, displaying song information, and presetting favorites make this unit even more convenient to use.

Shuffle/Repeat playback

Shuffle (Random) playback

Press  during playback.

- The shuffle indicator in the front panel display switches as shown below each time you press the button.



	Performs shuffle playback.*
Not displayed	Does not perform shuffle playback.

* The range of shuffle depends on the media being played back.

Repeat playback

Press  during playback.

- The repeat indicator in the front panel display switches as shown below each time you press the button.

	Repeats the song being played back.
	Performs repeat playback.*
Not displayed	Does not perform repeat playback.

* The range of repeat depends on the playback media.

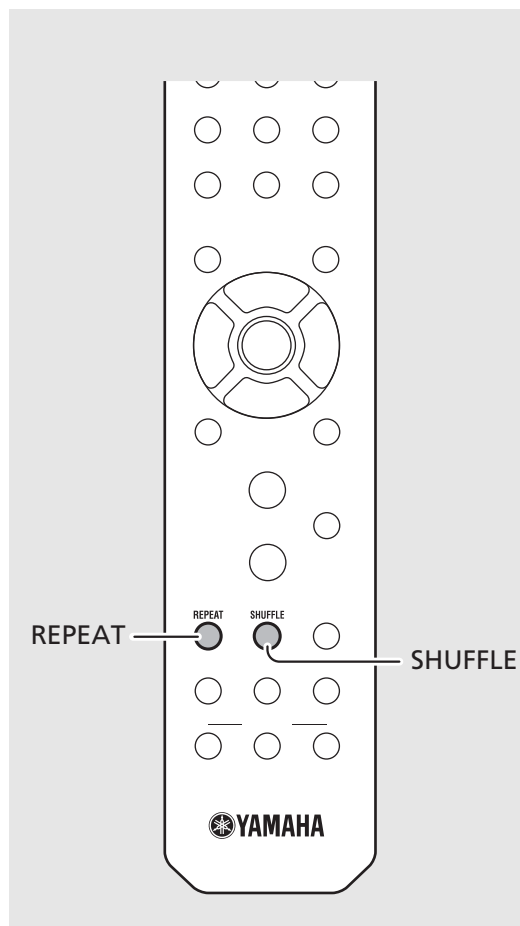

Note

- Operation is the same for playback of content from PCs (servers), USB devices, AirPlay, and CDs.

Playback information

While content from a PC (server), a USB device, AirPlay, or a CD is being played back, the song title, elapsed time, etc. can be shown on the front panel display.

Press  during playback.



ALBUM
▶ Meteora

- The display switches in the order shown below each time you press the button.

USB/AirPlay/Server	CD
Song title*1	Playing time
Artist name	Remaining time of the song*2
Album title	Remaining time of the disc*2
Playing time	Song title*1,*3
	Artist name*3
	Album title*3

*1 If the song title cannot be obtained, the file name may be displayed.

*2 Only when playing an audio CD.

*3 Only when playing an audio CD and when there is information to display.

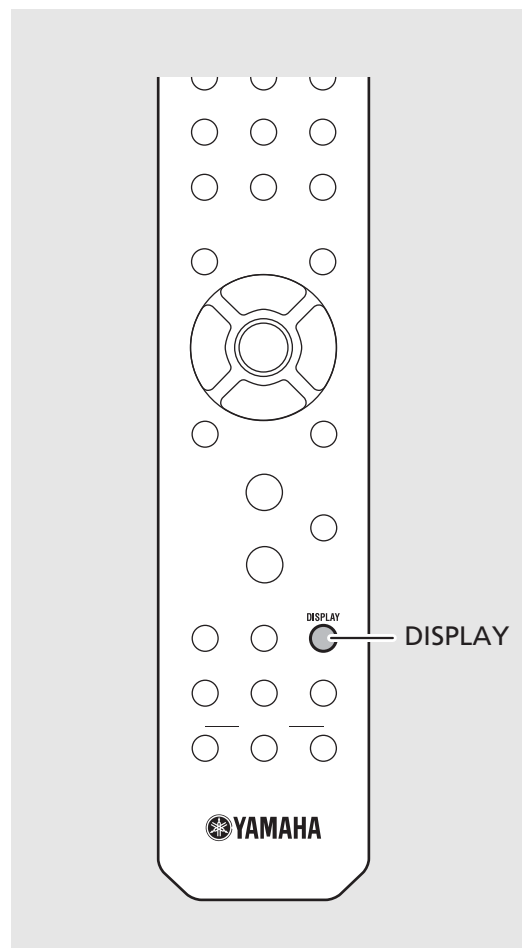

Note

- Characters shown on the front panel display are alphanumerics only.

Presetting content to FAVORITES

You can register your favorite content to the FAVORITES buttons (A to C) so that it can be played back easily in the future.

Presetting content

Press and hold any of the FAVORITES buttons during the playback of the content.

- The content being played back is registered to that FAVORITES button.

Selecting content that is registered to FAVORITES

Press the FAVORITES button to which the content that you want to play back is registered.

- The content that is registered to the pressed FAVORITES button is played back.

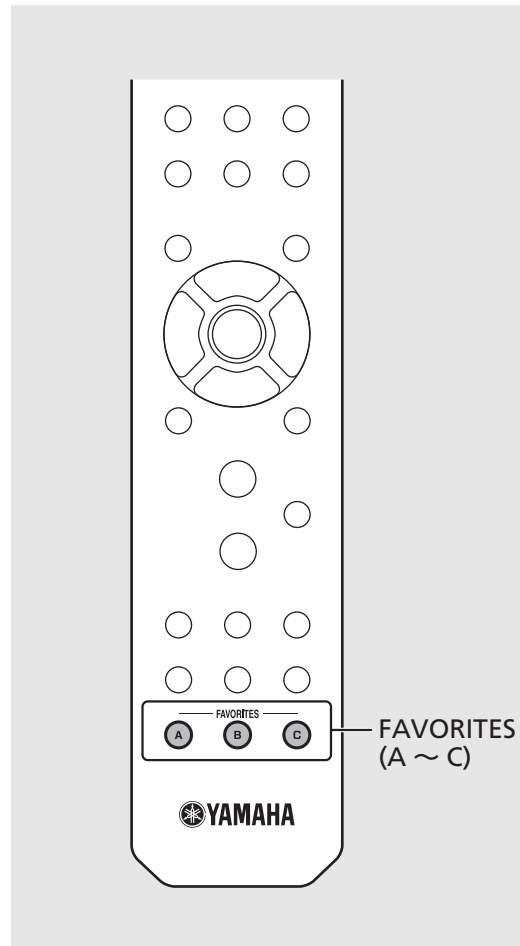

Note

- When presetting content to a FAVORITES button, any content that is already registered to that button will be replaced.
- Pressing a FAVORITES button triggers one of the actions below, depending on the input source of the content registered to it.

Input sources	What happens when the FAVORITES buttons are pressed
PC (Server)	The registered songs are played back.
NetRadio	The registered radio station is played back.
AirPlay*	The input source is switched to AirPlay.
Bluetooth*	The input source is switched to Bluetooth.
USB	The registered songs are played back.
CD	The registered songs are played back.
FM DAB (CRX-N470D only)	The registered radio/DAB station is played back.
AUX 1, 2*	Depending on the content that is registered, the input source is switched to AUX1 or AUX2.

* To play back content from this input source, the connected device must be configured.

Adjusting sound quality

The unit's sound quality can be adjusted. Refer to "Option menu for sound quality" at right.

- 1 Press **OPTION**.
- 2 Press **▲/▼** to select the desired item and press **ENTER**.
- 3 Press **▲/▼** to change the setting and press **ENTER**.
 - To set other items, repeat steps 2 and 3.
- 4 Press **OPTION** to exit the Option settings.

Using the sleep timer

You can set the time after which the unit automatically enters standby mode. The time can be selected from 120/90/60/30 min., or OFF.

Press **SLEEP** repeatedly to select the time.

- The SLEEP indicator lights up when the sleep timer is set.

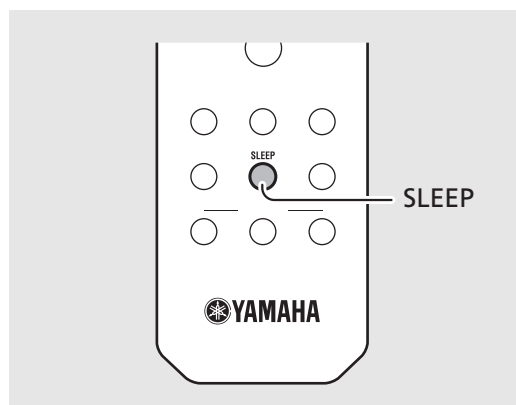
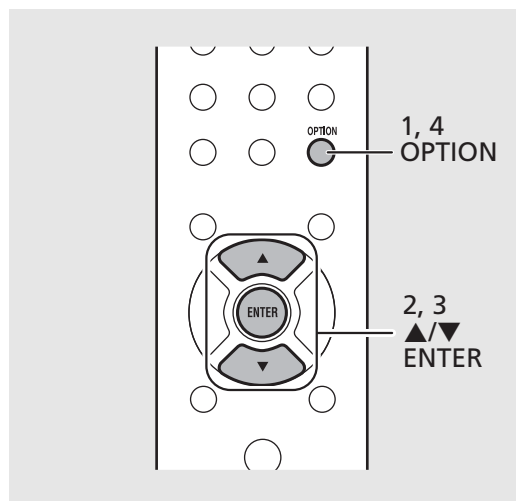

Note • To cancel audio quality configuration, press **OPTION**.

Option menu for sound quality

(**Bold: default**)

Equalizer

Adjusts low frequency [Bass] and high frequency [Treble].
The setting is also applied when using headphones.
(-10 to **0** to +10)

Balance

Adjusts the volume balance of the left and right speakers.
This setting is not applied when using headphones.
(Lch. +10 to **-center-** to Rch.+10)

Music Enhancer

Regenerates musical elements that are lost through compression.

(On, **Off**)

When playing back a high quality music source, such as FLAC or WAV, it is recommended to set this function to [Off]. When playing back an audio CD that has not been compressed, this function is not available even if [On] is set.

Note • To cancel the sleep timer, press **SLEEP** again.

Option settings

Option settings allow you to configure the unit to suit how you will use it.

- 1 Press **OPTION**.
 - The Option menu list is shown on the front panel display. Refer to “Option menu list” (P.45).
- 2 Select a desired option menu with **▲/▼** and press **ENTER**.



- 3 Change the setting with **▲/▼** and press **ENTER**.
 - Repeat step 3 if there is a sub menu.
 - Press **◀** to cancel the setting and return to the previous level.
 - Repeat steps 2 and 3 if you want to set another menu item.
- 4 Press **OPTION** to exit the Option settings.

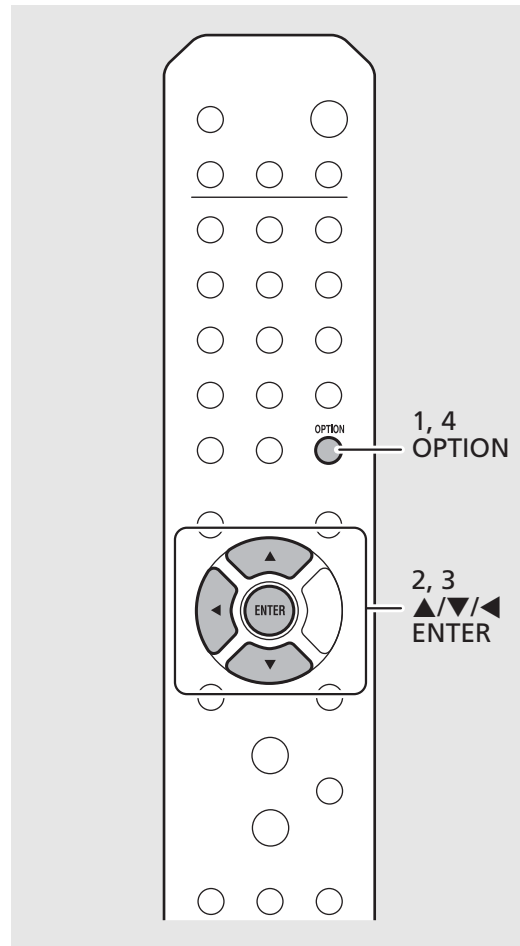

Option menu list

Menu	Sub menu	Default	Function
Preset Delete* ¹ (☞ P.32)			Deletes preset stations.
Auto Preset* ¹			Sets the Auto Preset.
Equalizer (☞ P.43)	Bass	0	Adjusts low frequency.
	Treble	0	Adjusts high frequency.
Balance (☞ P.43)		center	Adjusts the volume balance of the left and right speakers.
Music Enhancer (☞ P.43)		Off	Enables/disables Music Enhancer.
Initial Scan* ^{1,*2} (☞ P.28)			Scans all receivable frequencies and registers them in the unit.
Tune Aid* ^{1,*2} (☞ P.30)			Shows the level of received DAB signal.
Network Info	Status		Shows the connection status of the NETWORK jack.
	LAN MAC Address		Shows MAC address.
	WiFi MAC Address		Shows MAC address.
	Bluetooth Addr		Confirms the <i>Bluetooth</i> address.
	MusicCast Info		Shows the information on MusicCast.
	SSID		Confirms the SSID.
	Direct Info		Shows the information for Wireless Direct.
	Network Name		Shows the name of the unit that appears on the network.
	vTuner ID		Confirms the vTuner ID.
	IP Address	0.0.0.0	

Menu	Sub menu	Default	Function
Network Info	Subnet Mask	0.0.0.0	Confirms the subnet mask.
	Default Gateway	0.0.0.0	Confirms the default gateway.
	DNS Server(P)	0.0.0.0	Confirms the primary DNS server.
	DNS Server(S)	0.0.0.0	Confirms the secondary DNS server.
Network Config	Select Network	Wired	Selects a network connection method.
	DHCP	On	Enables/disables DHCP.
System Config	AutoPowerStby	On	Sets the unit to enter standby mode automatically (☞ P.16).
	Net Standby	On	Sets the network status for when the unit is in standby mode (☞ P.16).
	Bluetooth	On	Sets <i>Bluetooth</i> .
	Initialize Set		Resets to the factory default settings.
Firmware Update	Version		Shows the firmware version of the unit.
	Update	Network	Updates the firmware of the unit (☞ P.22).

*1 Only when the radio is played back









*2 CRX-N470D only

Troubleshooting

Refer to the table below when the unit does not function properly. If your problem is not listed below or if the instruction below does not help, turn off the unit, disconnect the power cable, and contact the nearest authorized Yamaha dealer or service center.

First, check that the connectors of each cable are securely inserted in to jacks on each device. Check also that the power cable is plugged into an outlet.

General

Problem	Cause	Solution
The unit enters the standby mode soon after the power is turned on. The unit does not operate properly.	The power cable is not properly connected.	Connect the power cable firmly.
	The unit got a strong electric shock from an outside source, such as lighting or excessive static electricity.	Hold down  on the front panel for more than 10 seconds to initialize and reboot the unit. (If the problem persists, unplug the power cable from the wall outlet and plug it again after 30 seconds or more.)
No sound.	No appropriate source has been selected.	Select an appropriate source with INPUT on the front panel or the source buttons on the remote control ( P.10, 13).
	Speaker connections are not secure.	Secure the connections ( P.14).
	The volume is minimum or mute.	Turn up the volume.
Sound is heard from the speaker on one side only.	Source device or speakers are not connected properly.	Connect the source device or speaker cables properly ( P.14, 27). If the problem persists, the cables may be defective.
Noise is heard.	This unit is too close to digital or radio-frequency equipment.	Move this unit away from such equipment.
	The audio cable between this unit and Source device is defective.	Connect the audio cable firmly. If the problem persists, use another audio cable.
The power suddenly turns off.	The sleep timer may be set ( P.43).	Turn on the unit and play the source again.
	Auto Power Standby function is activated. ( P.16).	
There is noise interference from digital or high-frequency equipment.	This unit is too close to the digital or high-frequency equipment.	Place this unit farther away from such equipment.
The remote control does not work or does not function properly.	The remote control may be outside its operation range.	Operate the remote control within its operation range ( P.16).
	The remote control sensor on this unit may be exposed to direct sunlight or strong lighting such as an inverter type fluorescent lamp.	Change the orientation of lighting or the unit, or location of the unit.
	The battery may be worn out.	Replace the batteries with new ones ( P.13).
	There are obstacles between the sensor of this unit and the remote control.	Remove the obstacles.

Network

Problem	Cause	Solution
The network feature does not function.	The network parameters (IP address) have not been obtained properly.	Enable the DHCP server function of the router. In addition, in the [Network Config] of the option settings of the unit, set [DHCP] to [On]. If you want to configure the network parameters manually, check that you are using an IP address which is not used by other network devices in your network (☞ P.45). For details on how to set the router, contact the manufacturer of the router.
Playback stops (songs cannot be played back continuously).	There are unsupported files in the server.	Remove the files (including image files or hidden files) which the unit does not support from the folder being played back.
The unit does not detect the PC.	The media sharing setting is not correct.	Configure the sharing setting and select the unit as a device to which music contents are shared (☞ P.35).
	Some security software installed on your PC is blocking the access of the unit to your PC.	Check the setting of the security software installed in your PC.
	The unit and PC are not in the same network.	Check the network connections and your router settings, and then connect the unit and the PC to the same network.
The files in the PC cannot be viewed or played back.	The files are not supported by the unit or the media server.	Use the file format supported by both the unit and the media server (☞ P.53).
Internet radio cannot be played.	The selected Internet radio station is currently not available.	There may be a network problem at the radio station, or the service may have been stopped. Try the station later or select another station.
	The selected Internet radio station is currently broadcasting silence.	Some Internet radio stations broadcast silence at certain of times of the day. In this case, no sound is output even if the signal is received. Try the station later or select another station.
	Access to the network is restricted by the firewall settings of your network devices (such as the router).	Check the firewall settings of your network devices. Internet radio can be played only when it passes through the port designated by each radio station. The port number varies depending on the radio station.
The dedicated application for mobile devices does not detect the unit.	The unit and mobile devices are not in the same network.	Check the network connections and your router settings, and then connect the unit and the PC to the same network.
Update of the firmware via network failed.	The network connection is unstable.	Try updating again after a while. Or update the firmware via USB memory device (☞ P.22).

Troubleshooting





Problem	Cause	Solution
The iPhone does not recognize the unit when using AirPlay.	A multi-SSID supported router is used.	The network separation function of the router may prevent the iPhone from accessing the unit. When connecting an iPhone, use SSID that can access the unit.
The unit cannot connect to the Internet via a wireless router (access point).	The wireless router is turned off.	Turn on the wireless router.
	The unit is placed too far from the wireless router.	Place the unit and the wireless router closer to each other.
	There is an obstacle between the unit and the wireless router.	Remove the obstacles.
Wireless network is not found.	Wireless communication is interrupted by the electromagnetic waves emitted from a microwave oven or other wireless devices.	When using the unit via wireless connection, place it away from devices emitting electromagnetic waves.
	Access to the network is restricted by the firewall settings of your wireless router.	Check the firewall setting of the wireless router.

Bluetooth

Problem	Cause	Solution
Cannot make the unit pair with a <i>Bluetooth</i> device.	The unit is turned off.	Turn the unit on and perform the pairing (☞ P.25).
	The [Bluetooth] of the option settings is set to [Off].	Set it to [On].
	Another <i>Bluetooth</i> device is connected.	Terminate current <i>Bluetooth</i> connection, and perform pairing with the new device.
	This unit and the device are too far apart.	Pair the unit and device within a distance of 10 m (33 ft).
	There is a device (microwave oven, wireless LAN, etc.) that outputs signals in the 2.4 GHz frequency band nearby.	Move this unit away from the device that is emitting radio-frequency signals.
	A <i>Bluetooth</i> adapter, etc., that you want to pair with this unit has a passkey other than "0000."	Use a device whose passkey is "0000."
	The <i>Bluetooth</i> device does not support A2DP.	Perform pairing with a device which supports A2DP.
Cannot make a <i>Bluetooth</i> connection.	The [Bluetooth] of the option settings is set to [Off].	Set it to [On].
	Another <i>Bluetooth</i> device is connected.	Terminate current <i>Bluetooth</i> connection, then establish a <i>Bluetooth</i> with that device again.
	The <i>Bluetooth</i> function of the device is turned off.	Turn on the <i>Bluetooth</i> function of the device.
	The pairing information has been deleted.	Delete the <i>Bluetooth</i> device's pairing information and perform pairing again.
	This unit is not registered on the device's <i>Bluetooth</i> connection list.	Perform pairing again (☞ P.25).

Problem	Cause	Solution
No sound is produced, or the sound is interrupted during playback.	The volume of the <i>Bluetooth</i> device is set too low.	Turn up the volume of the <i>Bluetooth</i> device.
	The <i>Bluetooth</i> device is not set to send <i>Bluetooth</i> audio signals to the unit.	Switch the output of <i>Bluetooth</i> audio signals of the <i>Bluetooth</i> device to the unit.
	The <i>Bluetooth</i> connection of the unit with the device has terminated.	Perform <i>Bluetooth</i> connection operations again (☞ P.25).
	There is a device (microwave oven, wireless LAN, etc.) that outputs signals in the 2.4 GHz frequency band nearby.	Move this unit away from the device that is emitting radio-frequency signals.
	This unit and the <i>Bluetooth</i> device are too far apart.	Move the <i>Bluetooth</i> device to within 10 m (33 ft) of the unit.
	The <i>Bluetooth</i> function of the device is turned off.	Turn on the <i>Bluetooth</i> function of the device.
	The <i>Bluetooth</i> device is not set to send <i>Bluetooth</i> audio signals to this unit.	Check that the <i>Bluetooth</i> function of the <i>Bluetooth</i> device is set properly.

Disc

Problem	Cause	Solution
Playback does not start after a disc is inserted. Some button operations do not work.	The disc inserted in the unit may not be supported.	Use a disc supported by the unit (☞ P.52).
Playback does not start (or stops immediately) after pressing  /  on the unit or  /  on the remote control.	The disc may be dirty.	Wipe the disc clean (☞ P.52).
	The disc inserted in the unit may not be supported.	Use a disc supported by the unit (☞ P.52).
	If the unit was moved from a cold to warm place, condensation may have formed on the disc reading lens.	Wait for an hour or two until the unit adjusts to the room temperature, and try again.

USB devices

Problem	Cause	Solution
The unit does not detect the USB device.	The USB device is not connected to the USB jack securely.	Turn off the unit, reconnect your USB device, and turn the unit on again (☞ P.24).
	A USB device in a format other than FAT16/32 format is used.	Use a USB device with FAT16 or FAT32 format.
Folders and files in the USB device cannot be viewed.	The data in the USB device is protected by encryption.	Use a USB device without an encryption function.

DAB reception (CRX-N470D only)

Problem	Cause	Solution
Cannot tune into any DAB stations.	The initial scan operations were not performed.	Perform the initial scan operations (☞ P.28).
The initial scan operations are not successful and [Not Found] is shown on the front panel display.	The DAB signals are too weak.	Use the DAB Tune Aid feature to conform the best position of the antenna (☞ P.30).
	The positioning of the antenna is not optimal for DAB reception.	
	There is no DAB coverage in your area.	Check with your dealer or WorldDMB online at http://www.worlddab.org for a listing of the DAB coverage in your area.
There is noise interference (e.g. hiss, crackle or jitter)	The antenna needs to be repositioned.	Readjust the position of the antenna (☞ P.15).
	The DAB signals are too weak.	Use the DAB Tune Aid feature to conform the best position of the antenna (☞ P.30).
The DAB station information is not shown or is inaccurate.	The DAB station may be temporarily out of service, or the DAB station information is not provided by the DAB broadcaster.	Contact the DAB broadcaster.

FM reception

Problem	Cause	Solution
FM stereo reception is noisy.	The antenna is not connected properly.	Make sure the antenna is connected properly and change the position of the antenna (☞ P.15).
	The radio station you selected may be far from your area, or the antenna input is poor.	Use a commercially available outdoor antenna. For details, consult a specialist store.
Automatic tuning does not work.	The radio station you selected may be far from your area, or the antenna input is poor.	Use a commercially available outdoor antenna. For details, consult a specialist store.
		Use the manual tuning method (☞ P.31).
Cannot select a preset radio station.	The preset (memory) may have been erased.	Preset radio stations again (☞ P.31, 32).
There is distortion, and clear reception cannot be obtained even with a good FM antenna or an outdoor antenna.	Multipath reflection or other radio interference may be occurring.	Change the height, direction, or placement of the antenna.

Messages on the front panel display

Message	Cause	Solution
Access Denied	Access to the PC is denied.	Configure the sharing settings and select the unit as a device to which music contents are shared (☞ P.35).
Access Error	The unit cannot access the USB device.	Turn off the unit and reconnect your USB device. If the problem persists, try another USB device.
	There is a problem with the signal path from the network to the unit.	Make sure your router and modem are turned on. Check the connection between the unit and your router (or hub) (☞ P.17).
Initializing	The unit is starting up.	Wait until the message disappears. If the message stays more than 3 minutes, turn off the unit and turn it on again.
Loading...	The unit is loading the specified file/content.	Wait until the unit finishes loading.
No Content	Selected folder does not contain playable files.	Select a folder with playable files (☞ P.53).
No Disc	The disc inserted in the unit may not be supported.	Use a disc supported by the unit (☞ P.52).
	The disc may be dirty, or foreign matter may be attached to it.	Wipe the disc clean. Alternatively, remove foreign matter adhered to the disc.
	Disc is set upside-down.	Set the disc with the labeled side facing up.
No Songs	The disc does not contain playable files.	Set a disc with playable files (☞ P.52).
Not Connected	The unit is not connected to the network.	Check the network connection.
Overcurrent	The connected USB device is not supported by the unit.	Disconnect the USB device, turn off the unit, and turn it on again. If this does not solve the problem for the USB device, it is not playable on the unit.
	USB device is not connected properly.	
Unable to play	The unit cannot play back the songs stored on the USB devices or the computer for some reason.	Check if the format of files you are trying to play is supported by the unit (☞ P.53).
Version Error	Firmware update has failed.	Update the firmware again.

Supported devices/media and file formats

Supported devices/ media

PCs

PC with Windows Media Player 11 or Windows Media Player 12 installed.

NAS

NAS compatible with DLNA version 1.5.

USB devices

- The unit is compatible with USB mass storage class devices (e.g., flash memories or portable audio players) using FAT16/FAT32 format.
- Do not connect devices other than the USB mass storage class devices (USB charger, USB hub, etc.), PCs, card readers, and external hard discs.
- USB devices with encryption cannot be used.
- Depending on the manufacturer or type of the USB device, the unit may not recognize the USB device or some functions may be unavailable.

Discs

- This unit is designed for use with audio CD, CD-R/RW (ISO 9660 format) with any of the following logos printed on the disc or the disc jacket.

Audio CD



CD-R/RW*



* Discs which bear one of the following.
FOR CONSUMER
FOR CONSUMER USE
FOR MUSIC USE ONLY

- 8-cm discs are playable with this unit.
Set a disc in the inner recessed area of the disc tray.

Notes on discs

- Do not set any other type of disc other than stated above in this unit. Doing so may damage the unit.
- CD-R/RW cannot be played back unless finalized. Finalization means the process for making a disc to be ready for playback on a compatible device.
- Some discs cannot be played back depending on the disc characteristics or recording conditions.
- Do not use any non-standard shaped discs such as a heart-shaped disc.
- Do not use discs with many scratches or a crack on their surface, or warped/glued discs.

Handling discs

- Do not touch the surface of the disc. Hold a disc by its edge or center hole.
- Use a soft-tipped pen when writing on the label side of a disc.
- Do not put tape, seal, glue, etc., on a disc.
- Do not use a protective cover to prevent scratches.
- Do not set foreign object on the disc tray.
- Do not set more than one disc in this unit at one time. This could cause damage to both this unit and the discs.
- If a disc becomes dirty, wipe it with a clean, dry soft cloth from the center out to the edge. Do not use record cleaner or paint thinner.
- Do not use any lens cleaners as they may cause malfunction.
- Do not expose discs to direct sunlight, high temperature, high humidity, or dust.
- When a disc is not being used, remove it from this unit and store in an appropriate case.

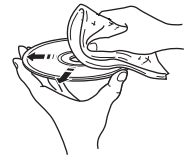
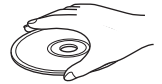

File format

File format the unit supporting is as follows.

DLNA/USB

Format	Sampling frequency (kHz)	Quantization bitrate (bit)	Bitrate (kbps)	Number of channels	Gapless playback supported
WAV*	32/44.1/48/ 88.2/96/176.4/ 192	16/24	-	2	✓
MP3	32/44.1/48	-	8-320	2	-
WMA	32/44.1/48	-	8-320	2	-
MPEG-4 AAC	32/44.1/48	-	8-320	2	-
FLAC	32/44.1/48/ 88.2/96/176.4/ 192	16/24	-	2	✓
ALAC	32/44.1/48/ 88.2/96	16/24	-	2	✓
AIFF	32/44.1/48/ 88.2/96/176.4/ 192	16/24	-	2	✓

* Linear PCM format only

- To play back FLAC files, you need to install server software that supports sharing of FLAC files via DLNA on your PC or use a NAS that supports FLAC files.
- Digital Rights Management (DRM) files cannot be played back.

Disc

Format	Sampling frequency (kHz)	Quantization bitrate
MP3	8-48	16
WMA	16-48	16

Specifications

Input

AUX IN	AUX 1	Stereo L/R: RCA
	AUX 2	3.5 mm stereo mini jack

CD

Laser	Type	Semiconductor laser GaAs/GaAlAs
	Wave length	790 nm
	Output power	7 mW
Media	CD, CD-R/RW	
Audio format	Audio CD, MP3, WMA	

USB

Supported file format	MP3, WMA, MPEG4 AAC, WAV, FLAC, ALAC, AIFF
-----------------------	--

Network

Interface	100Base-TX/10Base-T
Internet radio	vTuner service supported
PC client function	DLNA Ver. 1.5 (DMP/DMR function) supported
Supported file format	Same as USB supported file format
AirPlay	AirPlay supported

Wi-Fi

Wireless network standards	IEEE802.11 b/g/n
Radio frequency	2.4 GHz
Available security methods	WEP, WPA2-PSK (AES), Mixed Mode

Tuner

Preset memory	30	
Tuning range	FM	U.S.A. and Canada models: 87.5 MHz to 107.9 MHz Other models: 87.5 MHz to 108.0 MHz

DAB (CRX-N470D ONLY)

Preset Memory	30	
Tuning range	DAB	174 to 240 MHz (Band III)
Compatibility	DAB/DAB+	

Bluetooth

Bluetooth version	Ver. 2.1+EDR
Supported profile	A2DP (Advanced Audio Distribution Profile) AVRCP (Audio/Video Remote Control Profile)
Compatible codecs	SBC, AAC (AAC is Sink only)
Operating modes	Sink or Source
Wireless output	Bluetooth Class 2
Maximum communication range	10 m (33 ft) (without interference)

Amplifier section

Maximum output power	22 W + 22 W (6 Ω, 1 kHz, 10% THD)
Frequency response	20 Hz to 20 kHz (0±3 dB)
Total harmonic distortion	≤ 0.05 % (10 W/6 Ω 1 kHz)
Headphones	500 mV/32 Ω Input: 1 kHz 300 mV, 32 Ω terminated
Subwoofer output power	1.5 V/1 kΩ

General

Power supply/Frequency	AC 100 to 240 V, 50/60 Hz
Power consumption	25 W
Standby power consumption	Network standby off: 0.4 W Network standby on Wired (Ethernet): 1.8 W Wireless (Wi-Fi/Wireless Direct/Bluetooth): 1.9 W/1.9 W/1.7 W
Dimensions (W × H × D) (with wireless antenna upright)	270 × 110 × 330 mm (270 × 179 × 330 mm)
Weight	3.0 kg

The contents of this manual apply to the latest specifications as of the publishing date. To obtain the latest manual, access the Yamaha website then download the manual file.

Trademarks

AirPlay, iPad, iPhone, iPod, iPod touch and iTunes are trademarks of Apple Inc., registered in the U.S. and other countries.

AirPlay works with iPhone, iPad, and iPod touch with iOS 4.3.3 or later, Mac with OS X Mountain Lion or later, and Mac and PC with iTunes 10.2.2 or later.

(as of July 2015)



DLNA™ and DLNA CERTIFIED™ are trademarks or registered trademarks of Digital Living Network Alliance. All rights reserved. Unauthorized use is strictly prohibited.



The Wi-Fi CERTIFIED Logo is a certification mark of the Wi-Fi Alliance.

The Wi-Fi Protected Setup Identifier Mark is a mark of the Wi-Fi Alliance.

Wi-Fi, Wi-Fi Alliance, Wi-Fi CERTIFIED, Wi-Fi Protected Setup, WPA and WPA2 are trademark or registered trademark of Wi-Fi Alliance.



The *Bluetooth*® word mark and logos are registered trademarks owned by Bluetooth SIG, Inc. and any use of such marks by Yamaha Corporation is under license.

Bluetooth protocol stack (Blue SDK)

Copyright 1999-2014 OpenSynergy GmbH

All rights reserved. All unpublished rights reserved.



Digital Audio Broadcasting



Digital Audio Broadcasting

(For CRX-N470D)

The unit supports DAB/DAB+ tuning.

Explanations regarding GPL

This product utilizes GPL/LGPL open-source software in some sections. You have the right to obtain, duplicate, modify, and redistribute this open-source code only. For information on GPL/LGPL open source software, how to obtain it, and the GPL/LGPL license, refer to the Yamaha Corporation website (<http://download.yamaha.com/sourcecodes/musiccast/>).

Windows™

Windows is a registered trademark of Microsoft Corporation in the United States and other countries.

Internet Explorer, Windows Media Audio and Windows Media Player are either registered trademarks or trademarks of Microsoft Corporation in the United States and/or other countries.

Android™

Android and Google Play are trademarks of Google Inc.



MusicCast is a trademark or registered trademark of Yamaha Corporation.

VAROITUS

Muiden kuin tässä esitettyjen toimintojen säädön tai asetusten muutto saattaa altistaa vaaralliselle säteilylle tai muille vaarallisille toiminnoille.

DK

Advarsel: Usynlig laserstråling ved åbning når sikkerhedsafbrydere er ude af funktion. Undgå udsættelse for stråling.

Bemærk: Netafbryderen \ominus er sekundært indkoblet og afbryder ikke strømmen fra nettet. Den indbyggede netdel er derfor tilsluttet til lysnettet så længe netstikket sidder i stikkontakten.

N

Observer: Netbryteren \ominus er sekundært innkoblet. Den innebygdenetdelen er derfor ikke frakoplet nettet så lenge apparatet er tilsluttet nettkontakten.

S

Klass 1 laseraparat

Varning! Om apparaten används på annat sätt än i denna bruksanvisning specificerats, kan användaren utsättas för osynlig laserstråling, som överskrider gränsen för laserklass 1.

Observera! Strömbrytaren \ominus är sekundärt kopplad och inte bryter inte strömmen från nätet. Den inbyggda nät delen är därför ansluten till elnätet så länge stickproppen sitter i vägguttaget.

SF

Luokan 1 laserlaite

Varoitus! Laitteen käyttäminen muulla kuin tässä käyttöohjeessa mainitulla tavalla saattaa altistaa käyttäjän turvallisuusluokan 1 ylittävälle näkymättömälle lasersäteilylle.

Oikeus muutoksiin varataan. Laite ei saa olla alttiina tippu-ja roiskevedelle.

Huom. Toiminnanvalitsin \ominus on kytketty toisiopuolelle, eikä se kytke laitetta irti sähköverkosta. Sisäänrakennettu verkko-osa on kytkettynä sähköverkkoon aina silloin, kun pistoke on pistorasiassa.

OBSERVERA

Apparaten kopplas inte bort från växelströmskällan (nätet) så länge som den är ansluten till vägguttaget, även om själva apparaten har stängts av.

ADVARSEL

Netspændingen til dette apparat er IKKE afbrudt, så længe netledningen sidder i en stikkontakt, som er t endt - også selvom der er slukket på apparatets afbryder.

VAROITUS

Laitteen toisiopiiriin kytketty käyttökytkin ei irroita koko laitetta verkosta.

VARO!

AVATTAESSA JA SUOJALUKITUS OHITETTAESSA OLET ALTTIINA NÄKYMÄTTÖMÄLLE LASERSÄTEILYLLE. ÄLÄ KATSO SÄ TEESEEN.

WARNING!

OSYNLIG LASERSTRÅLNING NÄR DENNA DEL ÄR ÖPPNAD OCH SPÄRREN ÄR URKOPPLAD. BETRAKTA EJ STRÅLEN.

English

Important Notice: Guarantee Information for customers in EEA* and Switzerland

For detailed guarantee information about this Yamaha product, and Pan-EEA* and Switzerland warranty service, please either visit the website address below (Printable file is available at our website) or contact the Yamaha representative office for your country.
* EEA: European Economic Area

<http://europe.yamaha.com/warranty/>

Yamaha Global Site
<http://www.yamaha.com/>
Yamaha Downloads
<http://download.yamaha.com/>

Manual Development Group
© 2016 Yamaha Corporation

Published 06/2016 NV-A0

CRX-N4700M/EN