

RX-V667

Quick Reference Guide

Accessories

The following accessories are supplied with this product.



Remote control

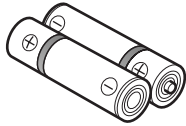

Batteries (2)
(AAA, R03, UM-4)

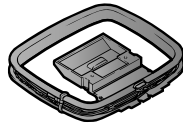

AM loop antenna



Indoor FM antenna



VIDEO AUX input cover



YPAO microphone

Preparing the remote control

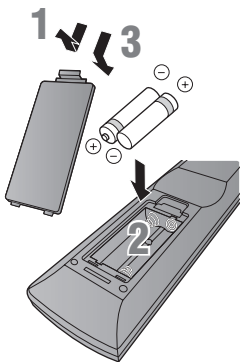

- 1 Take off the battery compartment cover.
- 2 Insert the two supplied AAA batteries into the battery case, following the polarity markings.
- 3 Snap the battery compartment cover back into place.

Be sure to aim the remote control directly at the remote control sensor on this unit during operation.

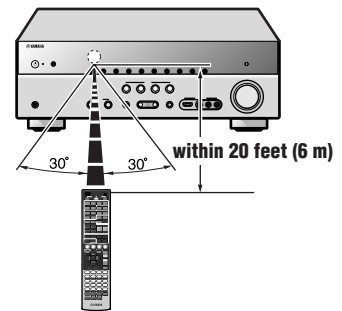

Items necessary for connection

Speakers



Front speaker

Ex.



Center speaker

Ex.



Surround speaker, surround back speaker, and presence speaker

Ex.

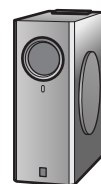

Active subwoofer

Ex.

- Use speakers with an impedance of at least 6Ω. 4Ω speakers can also be used as the front speakers. For more information on speaker impedance, refer to page 3.
- If you are using a CRT monitor, we recommend that you use magnetically shielded speakers.
- Prepare at least two front speakers. The priority of the other speakers is as follows:
 - 1 Two surround speakers
 - 2 One center speaker
 - 3 One (or two) surround back speaker (s)/presence speakers

External components



TV



Playback device such as
BD (Blu-ray Disc)/DVD players

Cable

- Cables for connecting external components (may differ depending on the components you are connecting)
- Speaker cables (a quantity to match the number of speakers you are connecting)
- Audio pin cable (for subwoofer)

Connect and install as follows the first time you use this unit.

See the following explanations for the connections for each number.

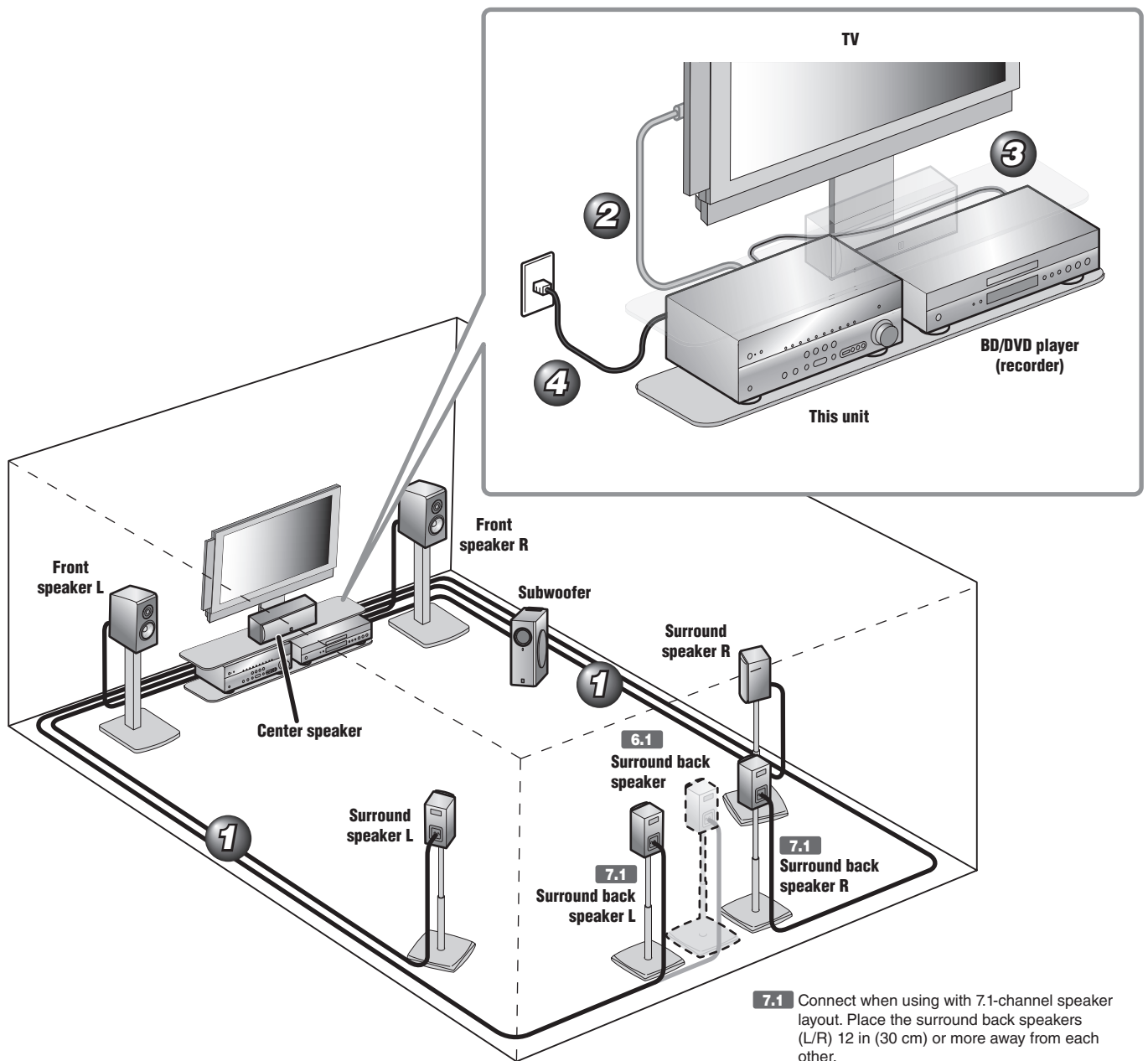

1 Connect the speakers

2 Connect a TV

3 Connect playback device such as BD/DVD players and recorders

4 Connect the AC power cable

5 Set up the speaker parameters automatically (YPAO)

7.1 Connect when using with 7.1-channel speaker layout. Place the surround back speakers (L/R) 12 in (30 cm) or more away from each other.

6.1 Connect when using with 6.1-channel speaker layout. Place the surround back speaker behind the listening position.

1

Connect the speakers

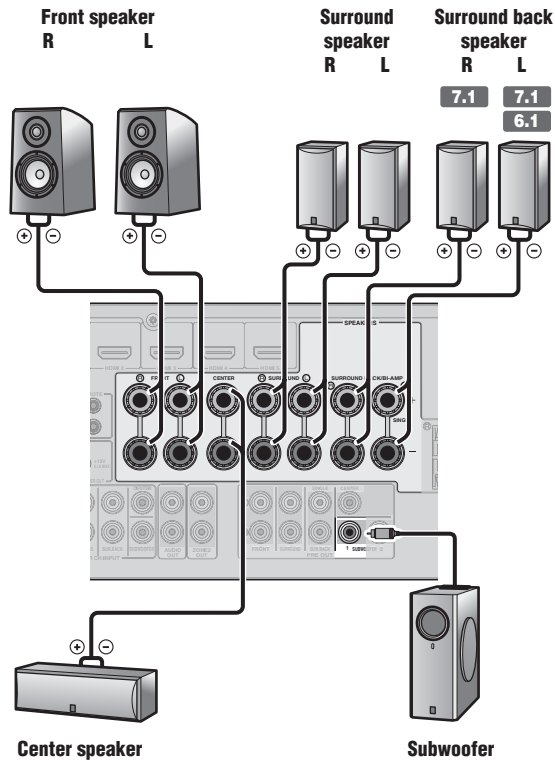

- 7.1** Connect when using with 7.1-channel speaker layout.
- 6.1** Connect when using with 6.1-channel speaker layout.

Caution:

- Remove the AC power cable of this unit from the power outlet before connecting the speakers.
- Generally speaker cables consist of two parallel insulated cables. One of these cables is a different color, or has a line running along it, to indicate different polarity. Insert the different colored (or lined) cable into the "+" (positive, red) terminal on this unit and the speakers, and the other cable into the "-" (minus, black) terminal.
- Be careful that the core of the speaker cable does not touch anything or come into contact with the metal areas of this unit. This may damage this unit or the speakers. If the speaker cables short circuit, "CHECK SP WIRES!" will appear on the front panel display when this unit is switched on.
- This unit is configured for 8Ω speakers at the factory setting. When connecting 6Ω speakers, configure the speaker impedance setting of this unit to 6Ω. When this unit is configured for 6Ω speakers, 4Ω speakers can also be used as the front speakers. For more information on setting the speaker impedance, refer to "Changing speaker impedance" in the Owner's Manual.
- When connecting the presence speakers, refer to "Presence speaker connection" in the Owner's Manual.
- This unit can connect speakers that support Bi-amp connection for front speakers. Refer to "Bi-amp connection" in the Owner's Manual for the details.

Connecting speakers

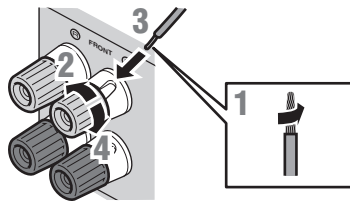

- Remove approximately 10 mm (0.4 in) of insulation from the ends of the speaker cables, and twist the bare wires of the cables together firmly so that they will not cause short circuits.
- Loosen the speaker terminals.
- Insert the bare wire of the speaker cable into the gap on the side of the terminal.
- Tighten the terminal.

Connecting the banana plug

Tighten the knob, and then insert the banana plug into the end of the terminal.

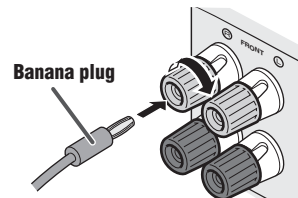

Connecting the subwoofer

- Connect the subwoofer input jack to the SUBWOOFER 1 or 2 jack on this unit with an audio pin cable.

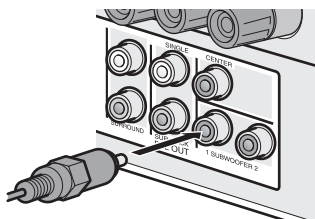

- Set the subwoofer volume as follows.

Volume: Set to approximately half volume (or slightly less than half).
Crossover frequency (if available): Set to maximum.

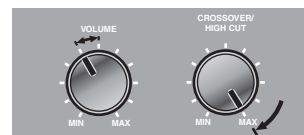

Subwoofer examples

2

Connect a TV

If your TV has multiple inputs, connect with the following priority (A to C).

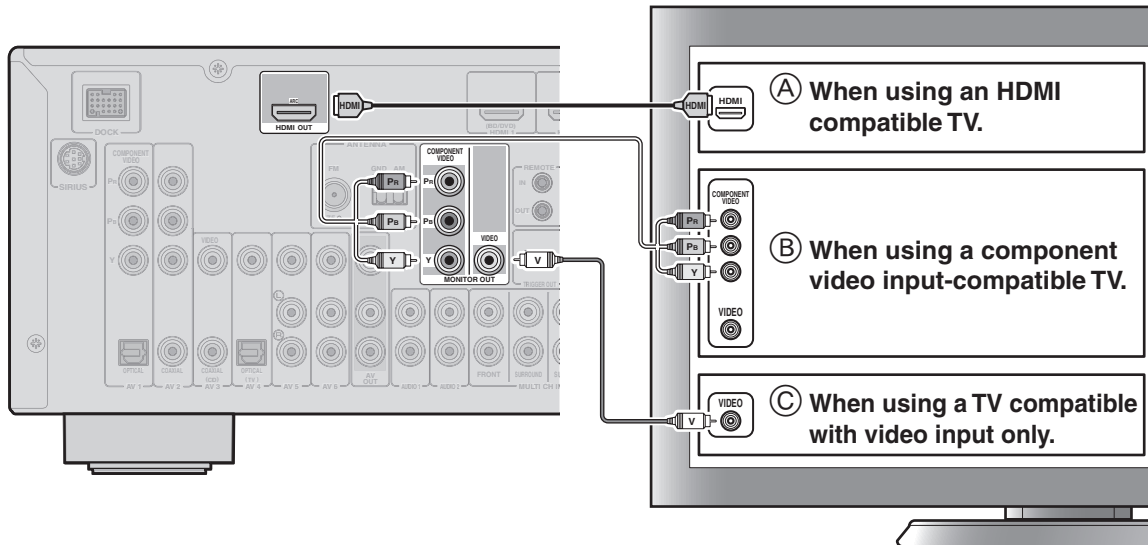

Video input to this unit is output to a TV using output jacks of the same kind.

When connecting to an HDMI compatible TV

Video signal such as component video and video received by this unit is converted to HDMI and output to the TV. Just select HDMI input on the TV to view video from any external source connected to this unit. You can change the resolution and aspect ratio used when converting to HDMI to suit your requirements.

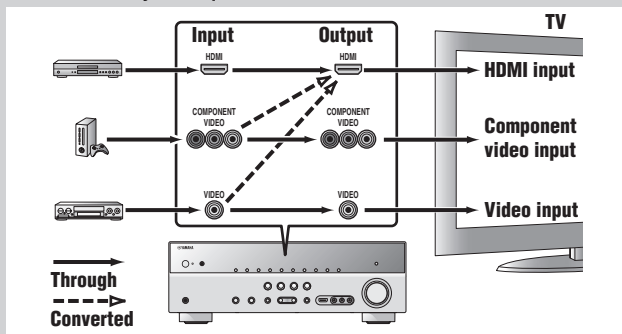

When connecting to a non-HDMI compatible TV

Connect to the TV using the same type of connection that you used to connect to the playback device, and change the inputs on your TV to match that of the playback device you are using for playback. If the playback device and TV are equipped with different types of analog video jacks, this unit will convert the video signal to component video signal, or vice-versa, according to the type of video input jacks used by the TV. For more information on video signal conversion, refer to "Connecting a TV monitor" in the Owner's Manual.

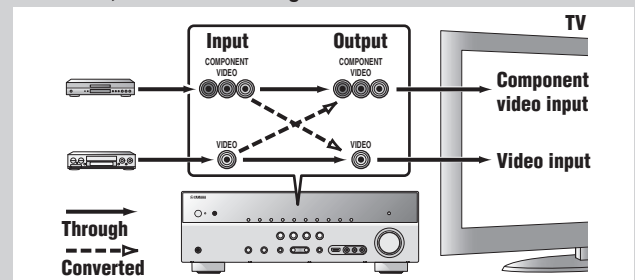

Listening to TV audio

To playback TV audio on this unit, connect the TV audio output to this unit.

Connect the following input jacks, matching the audio output jacks on your TV. When viewing your TV, select the appropriate input source on this unit.

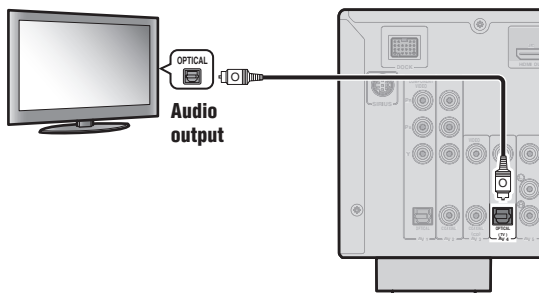

Audio output from TV	Input jack on this unit
Optical digital output	AV1 or AV4
Coaxial digital output	AV2 or AV3
Analog output	One of AV5, AV6, AUDIO1, AUDIO2, and VIDEO-AUX
HDMI Audio Return Channel (Described in the right column)	HDMI OUT

* Connecting to AV4 allows you to playback TV audio just by pressing the **TV** under **SCENE** key.

When using an HDMI compatible TV that supports Audio Return Channel functions and / or HDMI Control functions (e.g., Panasonic VIERA Link), you can enjoy the TV sound on this unit as follows:

When using a TV that supports the Audio Return Channel function and HDMI Control function

The audio / video output from the unit to the TV and audio output from the TV to the unit are possible using a single HDMI cable. The input source is switched automatically to match operations carried out on the TV, and that makes TV sound control easier to use.

For the connections and settings, refer to "Using the HDMI Control function" in the Owner's Manual.

When using a TV that supports HDMI Control functions

When HDMI Control functions are enabled on the unit, input source can be switched automatically to match operations carried out on the TV.

For the connections and settings, refer to "Using the HDMI Control function" in the Owner's Manual.

3

Connect playback device such as BD/DVD players and recorders

If your playback device has multiple audio/video outputs, connect with the following priority (A) to (D) to enjoy a higher quality sounds and images.

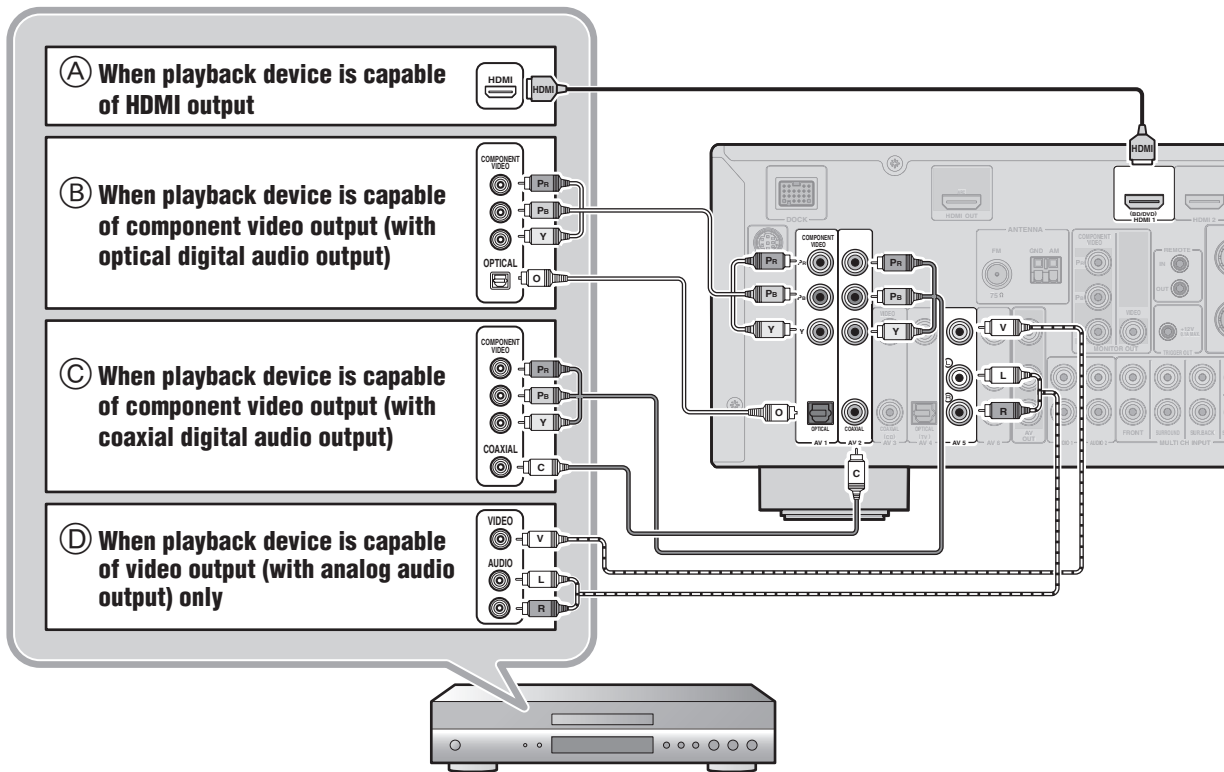

- When playback, select the corresponding input source to which the jack is connected.
- At the default settings, input sources and sound programs are preset on the **SCENE** keys. When a playback device is connected to HDMI 1 pressing **BD/DVD** under **SCENE** key selects the HDMI 1 input. When a playback device is connected to AV3, pressing **CD** under **SCENE** selects the AV3 input. The input source and sound program preset on the **SCENE** key can be changed. For more information on the **SCENE** function, refer to "Changing input settings with a single key (SCENE function)" in the Owner's Manual.
- If necessary, you can connect components that cannot be connected using the above methods, such as devices that output video from component video output jacks and audio from analog output jacks. Refer to "Connecting external components" in the Owner's Manual for details.

4

Connect the AC power cable

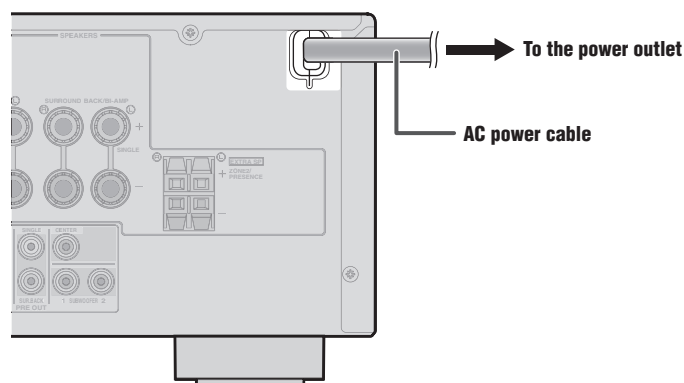

5

Set up the speaker parameters automatically (YPAO)

When all connections are complete, adjust the configuration, sizes, and volume balance of the speakers to provide an optimal sound field. This unit is equipped with a Yamaha Parametric Room Acoustic Optimizer (YPAO) function that adjusts the speaker balance automatically with a simple procedure.

When using YPAO, a test tone will be output from the speakers for approximately 3 minutes to measure acoustics. Be aware of the following when using YPAO.

- The test tone is output at high volume. Refrain from using this function at night when it may be a nuisance to others.
- Take care that the test tone does not frighten small children.

YPAO operations can be viewed on the front panel display or TV screen. TV display is used here to explain operation.

1 Check the following before using YPAO.

This unit

- The headphones are removed.

TV

- This unit is connected to the TV correctly.
- The power is turned on.
- The video input to which the video output from this unit has been selected.

Subwoofer

- The power is turned on.
- Volume is set to approximately half, and the cross-over frequency (if present) is set to maximum.

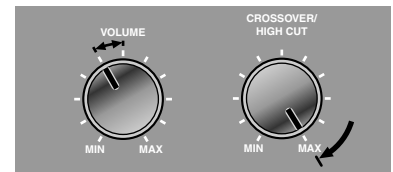

Subwoofer examples

2 Place the supplied YPAO microphone at ear height in your listening position.

When positioning the microphone, we recommend that you use equipment that allows you to adjust the height (such as a tripod) as a microphone stand. When using a tripod, use the tripod screws to fix the microphone in place.

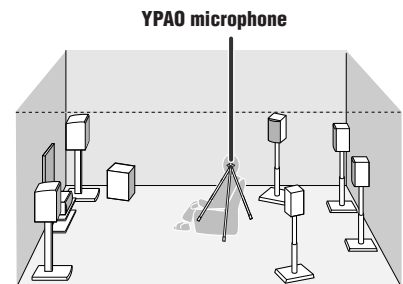

3 Press **RECEIVER** on the remote control to switch this unit on.

4 Connect the YPAO microphone to the YPAO MIC jack on the front panel.

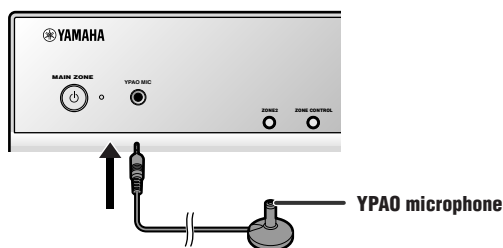

"Mic On. View ON SCREEN" appears on the front panel display, and then the display at right appears on the TV screen.

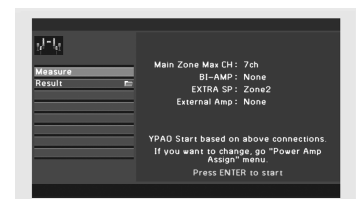

This completes preparation. To achieve more accurate results, take note of the following when measuring acoustics.

- It takes approximately 3 minutes to accurately measure acoustics. Keep the room as quiet as possible while acoustics are measured.
- Wait in a corner of the room, or leave it entirely, while acoustics are measured to avoid creating an obstruction between the speakers and the YPAO microphone.

Continues to the next page

- 5** Use the **cursor** Δ/∇ to select the “Measure” and press **ENTER** to start measurement.

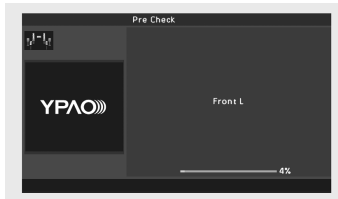

The following display appears if measurement finishes without any problems.



Result

Displays the results of automatic acoustics measurement and sets the equalizer (parametric equalizer) to provide a unified sound field. For details, refer to “Reviewing and reloading the automatic setup parameters” in the Owner’s Manual.

Save/Exit

Applies the result to the speaker setup and finishes the automatic measurement.

Note

If a problem occurs, an error message or report is displayed either during or after acoustic measurement. Refer to “When an error message is displayed during measurement,” or “When a warning message is displayed after measurement” in the Owner’s Manual to resolve the problem and measure acoustics with YPAO again.

- 6** Use the **cursor** Δ/∇ to select “Save/Exit” and press **ENTER**.

- 7** Use the **cursor** $\triangleleft/\triangleright$ to select “SAVE” and press **ENTER**.

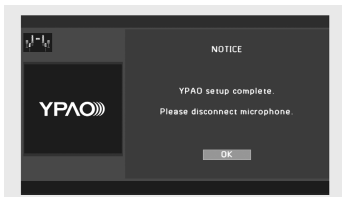

When the display at left appears, the YPAO setup is complete.

- 8** Press **ENTER**.

YPAO is automatically terminated. Disconnect the YPAO microphone.

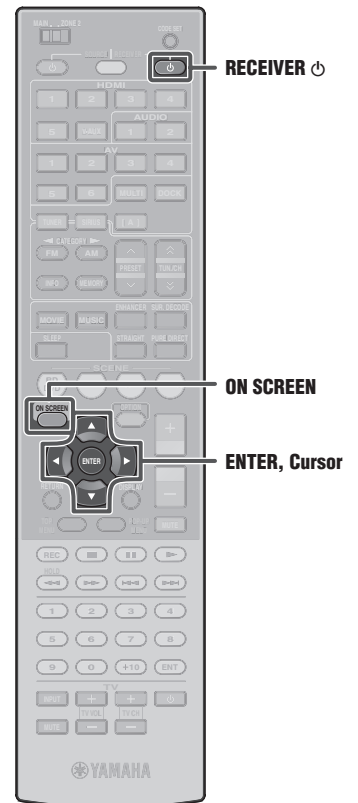
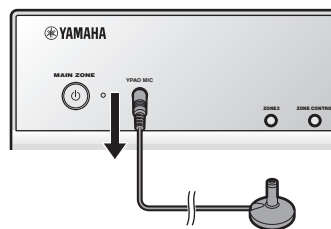

You can use the following functions with this unit. For details on the operations, refer to the Owner’s Manual on the supplied CD-ROM.

■ Adjustment for various parameters to match your listening environment

- Sound quality control with a parametric equalizer <PEQ Select>
- Easy listening at low volumes <Adaptive DRC>
- Adjusting volume between input sources <Volume Trim>

■ External device connection and playback

- Connections and playback from BD/DVD players (recorders), TV audio, and other devices
- Playback from an iPod/iPhone
- Playback from a Bluetooth device

■ FM/AM tuner

- Manual preset tuning

etc.

Operation guide

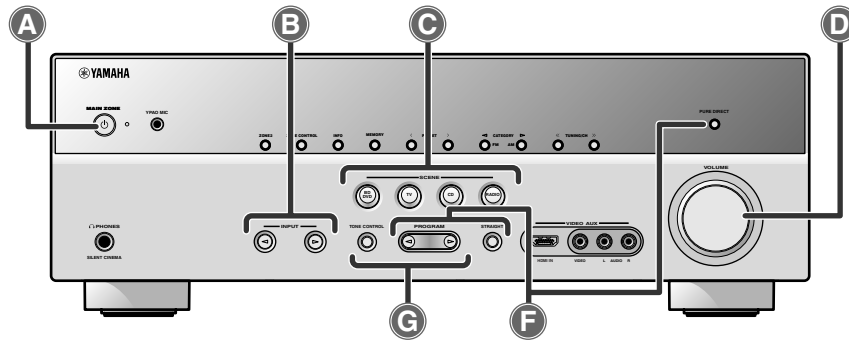

A Switches this unit between on and standby mode

This unit switches between on and standby mode every time you press this key.

B Choose an input source to listen to

The name of the selected input source appears on the front panel display.



C Switches between input settings

You can switch input sources and sound field programs with a single key.

SCENE	Input	Sound field program
BD/DVD	HDMI1	Drama
TV	AV4	STRAIGHT
CD	AV3	STRAIGHT
RADIO	TUNER	STRAIGHT

- Pressing and holding this key allows you to store input sources/sound field programs.
- Press this key when this unit is in standby mode to switch on the unit.

D Adjusts the volume level

The current volume level is displayed on the front panel display.



E Mutes the sound

The indicator blinks while the sound is muted.

F Select sound field programs and sound decoders

Front panel	Remote control	Description
PROGRAM	MOVIE	Selects sound field programs optimized for viewing movies, dramas, and sports.
	MUSIC	Selects sound field programs optimized for appreciating music.
	SUR. DECODE	Selects surround decoders such as Dolby Pro Logic II.
STRAIGHT	STRAIGHT	Switches to Straight decoding mode for stereo/multi-channel playback without using a sound field program.
PURE DIRECT	PURE DIRECT	Switches to Pure Direct mode for faithful reproduction of audio.

- When playing back compression artifacts, press **ENHANCER** to turn on the Compressed Music Enhancer mode.

G Adjusting high/low-frequency sound (Tone control)

1 Press **TONE CONTROL** to select "Treble" or "Bass."



2 Press **PROGRAM** < / > to adjust the output level in those frequency ranges.

- You can set the tone control for speakers and headphones separately. Connect the headphones when adjusting the headphone tone control.
- If you set an extreme tone balance, sounds may not match those from other channels.

