





YST-SW1500

Subwoofer System



OWNER'S MANUAL

IMPORTANT SAFETY INSTRUCTIONS

	CAUTION RISK OF ELECTRIC SHOCK DO NOT OPEN	
CAUTION: TO REDUCE THE RISK OF ELECTRIC SHOCK, DO NOT REMOVE COVER (OR BACK). NO USER-SERVICEABLE PARTS INSIDE. REFER SERVICING TO QUALIFIED SERVICE PERSONNEL.		

• Explanation of Graphical Symbols

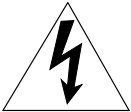

The lightning flash with arrowhead symbol, within an equilateral triangle, is intended to alert you to the presence of uninsulated "dangerous voltage" within the product's enclosure that may be of sufficient magnitude to constitute a risk of electric shock to persons.



The exclamation point within an equilateral triangle is intended to alert you to the presence of important operating and maintenance (servicing) instructions in the literature accompanying the appliance.

WARNING TO REDUCE THE RISK OF FIRE OR ELECTRIC SHOCK, DO NOT EXPOSE THIS APPLIANCE TO RAIN OR MOISTURE.

IMPORTANT Please record the serial number of this unit in the space below. MODEL: Serial No.: The serial number is located on the rear of this unit. Retain this Owner's Manual in a safe place for future reference.

- 1 Read these instructions.
- 2 Keep these instructions.
- 3 Heed all warnings.
- 4 Follow all instructions.
- 5 Do not use this apparatus near water.
- 6 Clean only with dry cloth.
- 7 Do not block any ventilation openings. Install in accordance with the manufacturer's instructions.
- 8 Do not install near any heat sources such as radiators, heat registers, stoves, or other apparatus (including amplifiers) that produce heat.
- 9 Do not defeat the safety purpose of the polarized or grounding-type plug. A polarized plug has two blades with one wider than the other. A grounding type plug has two blades and a third grounding prong. The wide blade or the third prong are provided for your safety. If the provided plug does not fit into your outlet, consult an electrician for replacement of the obsolete outlet.
- 10 Protect the power cord from being walked on or pinched particularly at plugs, convenience receptacles, and the point where they exit from the apparatus.
- 11 Only use attachments/accessories specified by the manufacturer.
- 12 Use only with the cart, stand, tripod, bracket, or table specified by the manufacturer, or sold with the apparatus. When a cart is used, use caution when moving the cart/ apparatus combination to avoid injury from tip-over. 
- 13 Unplug this apparatus during lightning storms or when unused for long periods of time.
- 14 Refer all servicing to qualified service personnel. Servicing is required when the apparatus has been damaged in any way, such as power-supply cord or plug is damaged, liquid has been spilled or objects have fallen into the apparatus, the apparatus has been exposed to rain or moisture, does not operate normally, or has been dropped.

FCC INFORMATION (for US customers)

1. IMPORTANT NOTICE : DO NOT MODIFY THIS UNIT!

This product, when installed as indicated in the instructions contained in this manual, meets FCC requirements. Modifications not expressly approved by Yamaha may void your authority, granted by the FCC, to use the product.

2. IMPORTANT : When connecting this product to accessories and/or another product use only high quality shielded cables. Cable/s supplied with this product **MUST** be used. Follow all installation instructions. Failure to follow instructions could void your FCC authorization to use this product in the USA.

3. NOTE : This product has been tested and found to comply with the requirements listed in FCC Regulations, Part 15 for Class "B" digital devices. Compliance with these requirements provides a reasonable level of assurance that your use of this product in a residential environment will not result in harmful interference with other electronic devices.

This equipment generates/uses radio frequencies and, if not installed and used according to the instructions found in the users manual, may cause interference harmful to the operation of other electronic devices.

Compliance with FCC regulations does not guarantee that interference will not occur in all installations. If this product is found to be the source of interference, which can be determined by turning the unit "OFF" and "ON", please try to eliminate the problem by using one of the following measures:

Relocate either this product or the device that is being affected by the interference.

Utilize power outlets that are on different branch (circuit breaker or fuse) circuits or install AC line filter/s.

In the case of radio or TV interference, relocate/reorient the antenna. If the antenna lead-in is 300 ohm ribbon lead, change the lead-in to coaxial type cable.

If these corrective measures do not produce satisfactory results, please contact the local retailer authorized to distribute this type of product. If you can not locate the appropriate retailer, please contact Yamaha Electronics Corp., U.S.A. 6660 Orangethorpe Ave, Buena Park, CA 90620.

The above statements apply **ONLY** to those products distributed by Yamaha Corporation of America or its subsidiaries.

We Want You Listening For A Lifetime

YAMAHA and the Electronic Industries Association's Consumer Electronics Group want you to get the most out of your equipment by playing it at a safe level. One that lets the sound come through loud and clear without annoying blaring or distortion – and, most importantly, without affecting your sensitive hearing.

Since hearing damage from loud sounds is often undetectable until it is too late, YAMAHA and the Electronic Industries Association's Consumer Electronics Group recommend you to avoid prolonged exposure from excessive volume levels.



CHECKING THE ACCESSORIES

Check your package to make sure it contains the following items.

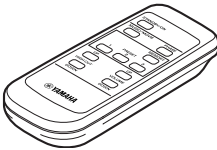
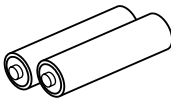
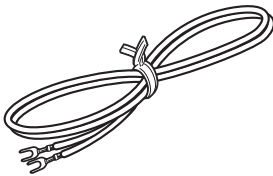
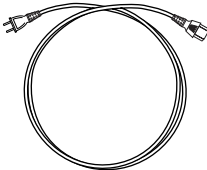
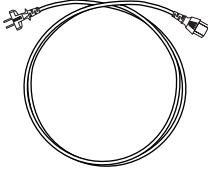
● Remote control	● Batteries (size AA, UM-3, R6)	● Grounding cable
		
● Power cable (U.S.A., Canada, Europe and Korean models only)		
		
(U.S.A. and Canada models)	(Europe and Korean models)	

For U.K. customers

If the socket outlets in the home are not suitable for the plug supplied with this appliance, it should be cut off and an appropriate 3 pin plug fitted. For details, refer to the instructions described below.

Note: The plug severed from the mains lead must be destroyed, as a plug with bared flexible cord is hazardous if engaged in a live socket outlet.

SPECIAL INSTRUCTIONS FOR U.K. MODEL

IMPORTANT:

THE WIRES IN MAINS LEAD ARE COLOURED IN ACCORDANCE WITH THE FOLLOWING CODE:

Blue: NEUTRAL

Brown: LIVE

As the colours of the wires in the mains lead of this apparatus may not correspond with the coloured markings identifying the terminals in your plug, proceed as follows: The wire which is coloured BLUE must be connected to the terminal which is marked with the letter N or coloured BLACK. The wire which is coloured BROWN must be connected to the terminal which is marked with the letter L or coloured RED. Making sure that neither core is connected to the earth terminal of the three pin plug.

CAUTION: Read this before operating your unit.

Please read the following operating precautions before use. YAMAHA will not be held responsible for any damage and/or injury caused by not following the cautions below.

- To assure the finest performance, please read this manual carefully. Keep it in a safe place for future reference.
- Install this unit in a cool, dry, clean place – away from windows, heat sources, sources of excessive vibration, dust, moisture and cold. Avoid sources of humming (transformers, motors). To prevent fire or electrical shock, do not expose this unit to rain or water.
- Never open the cabinet. If something drops into the set, contact your dealer.
- The voltage to be used must be the same as that specified on the rear panel. Using this unit with a higher voltage than specified is dangerous and may cause a fire and/or electric shock.
- To reduce the risk of fire or electric shock, do not expose this unit to rain or moisture.
- Do not use force on switches, controls or connection wires. When moving the unit, first disconnect the power plug and the wires connected to other equipment. Never pull the wires themselves.
- When not planning to use this unit for a long period (i.e. vacation, etc.), disconnect the AC power plug from the wall outlet.
- To prevent lightning damage, disconnect the AC power plug when there is an electric storm.
- Since this unit has a built-in power amplifier, heat will radiate from the rear panel. Place the unit apart from the walls, allowing enough spaces above, behind and on both sides of the unit to prevent fire or damage. Furthermore, do not position with the rear panel facing down on the floor or other surfaces. Be sure to allow spaces of at least 20 cm above, behind and on both sides of the unit.
- Do not cover the rear panel of this unit with a newspaper, a tablecloth, a curtain, etc. in order not to obstruct heat radiation. If the temperature inside the unit rises, it may cause fire, damage to the unit and/or personal injury.
- Do not place small metallic objects on this unit. Otherwise, the object may fall, possibly causing an injury.
- Do not place the following objects on this unit:
Glass, china, etc.
If glass etc. falls by vibrations and breaks, it may cause personal injury.
A burning candle etc.
If the candle falls by vibrations, it may cause fire and personal injury.
A vessel with water in it
If the vessel falls by vibrations and water spills, it may cause damage to the unit, and/or you may get an electric shock.
- Do not place this unit where foreign objects such as water drips might fall. It might cause a fire, damage to this unit, and/or personal injury.
- Never place a fragile object near the YST port of this unit. If the object falls or drops by the air pressure, it may cause damage to the unit and/or personal injury.
- Never put a hand or a foreign object into the YST port located on the front of this unit. When moving this unit, do not hold the port as it might cause personal injury and/or damage to this unit.
- Never open the cabinet. It might cause an electric shock since this unit uses a high voltage. It might also cause personal injury and/or damage to this unit.
- When using a humidifier, be sure to avoid condensation inside this unit by allowing enough spaces around this unit or avoiding excess humidification. Condensation might cause a fire, damage to this unit, and/or electric shock.
- Super-bass frequencies reproduced by this unit may cause a turntable to generate a howling sound. In such a case, move this unit away from the turntable.
- This unit may be damaged if certain sounds are continuously outputted at high volume level. For example, if 20 Hz–50 Hz sine waves from a test disc, bass sounds from electronic instruments, etc. are continuously outputted, or when the stylus of a turntable touches the surface of a disc, reduce the volume level to prevent this unit from being damaged.
- If you hear distorted noise (i.e., unnatural, intermittent “rapping” or “hammering” sounds) coming from this unit, reduce the volume level. Extremely loud playing of a movie soundtrack’s low frequency, bass-heavy sounds or similarly loud popular music passages can damage this speaker system.
- Vibration generated by super-bass frequencies may distort images on a TV. In such a case, move this unit away from the TV set.
- Do not attempt to clean this unit with chemical solvents as this might damage the finish. Use a clean, dry cloth.
- Be sure to read the “TROUBLESHOOTING” section regarding common operating errors before concluding that the unit is faulty.
- **Secure placement or installation is the owner’s responsibility.**
YAMAHA shall not be liable for any accident caused by improper placement or installation of speakers.

Standby mode

When this unit is turned off by pressing the STANDBY/ON button on the front panel, this unit consumes a small amount of power. This state is called the standby mode. This unit’s power supply is completely cut off from the AC line only when the POWER switch is set in the OFF position or the AC power cable is disconnected.

This unit features a magnetically shielded design, but there is still a chance that placing it too close to a TV set might impair picture color. Should this happen, move this unit away from the TV set.

IFOR CANADIAN CUSTOMERS

To prevent electric shock, match wide blade of plug to wide slot and fully insert.
This Class B digital apparatus complies with Canadian ICES-003.

CONTENTS

IMPORTANT SAFETY INSTRUCTIONS	II	NOTES ABOUT THE REMOTE CONTROL	11
CHECKING THE ACCESSORIES	IV	CONTROLS AND THEIR FUNCTIONS	12
CAUTION	1	AUTOMATIC POWER-SWITCHING FUNCTION	14
FEATURES	2	ADJUSTING THE SUBWOOFER BEFORE USE	15
PLACEMENT	3	Storing preset data of the VOLUME control etc.	16
CONNECTIONS	4	Frequency characteristics	17
Connecting to line output (pin jack) terminals of the amplifier	4	ADVANCED YAMAHA ACTIVE SERVO TECHNOLOGY	18
Connecting to speaker output terminals of the amplifier	6	TROUBLESHOOTING	19
Connecting to H.P.F. OUTPUT terminals	8	SPECIFICATIONS	Back cover
Ground connection	10		
Connecting the AC power cable	11		

FEATURES

- This subwoofer system employs Advanced YAMAHA Active Servo Technology which YAMAHA has developed for reproducing higher quality super-bass sound. (Refer to page 18 for details on Advanced YAMAHA Active Servo Technology.) This super-bass sound adds a more realistic, theater-in-the-home effect to your stereo system.
- This subwoofer can be easily added to your existing audio system by connecting to either the speaker terminals or the line output (pin jack) terminals of the amplifier.
- For the effective use of the subwoofer, the subwoofer's super-bass sound should be matched to the sounds of your main speakers. You can create the best sound quality for various listening conditions by using the HIGH CUT control and the PHASE button.
- You can make setting changes and adjustments for the subwoofer by using the remote control without moving from your listening position.
- The Automatic power-switching function saves you the trouble of pressing the STANDBY/ON button to turn the power on and off.
- You can select bass effect suitable for the source by using the B.A.S.S. button.
- The use of the H.P.F. OUTPUT terminals for connecting with the amplifier is effective for improving sound quality of your speaker system. This connection prevents sound output from the main speakers from muddying by filtering out low frequencies of input signals to be sent to the main speakers which are not suitable for reproducing low frequencies.



QD·Bass
TECHNOLOGY

QD-Bass Technology

QD-Bass (Quatre Dispersion Bass) technology uses square, pyramid-shaped reflective plates to radiate the sound in four horizontal directions.

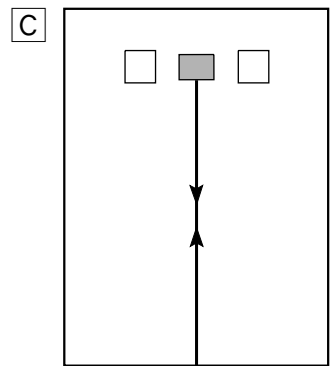
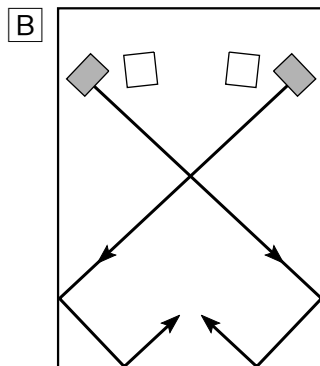
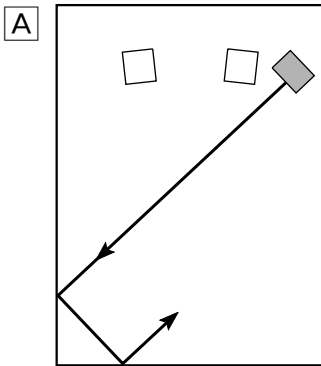
PLACEMENT



( : subwoofer,  : main speaker)

One subwoofer will have a good effect on your audio system, however, the use of two subwoofers is recommended to obtain more effect.

If using one subwoofer, it is recommended to place it on the outside of either the right or the left main speaker. (See fig. [A](#).) If using two subwoofers, it is recommended to place them on the outside of each main speaker. (See fig. [B](#).) The placement shown in fig. [C](#) is also possible, however, if the subwoofer system is placed directly facing the wall, the bass effect may die because the sound from it and the sound reflected by the wall may cancel out each other. To prevent this from happening, face the subwoofer system at an angle as in fig. [A](#) or [B](#).

Note

There may be a case that you cannot obtain enough super-bass sounds from the subwoofer when listening in the center of the room. This is because “standing waves” have been developed between two parallel walls and they cancel the bass sounds.

In such a case, face the subwoofer obliquely to the wall. It also may be necessary to break up the parallel surfaces by placing bookshelves etc. along the walls.

CONNECTIONS

Caution: Plug in the subwoofer and other audio/video components after all connections are completed.

- All connections must be correct, that is to say L (left) to L, R (right) to R, “+” to “+” and “-” to “-”. Also refer to the owner’s manual for each of your components.
- The subwoofer can be connected to either the line output (pin jack) terminals or the speaker output terminals of the amplifier. Choose one of the ways shown in this section that is more suitable for your audio system. Also, refer to the owner’s manual of your component to be connected to the subwoofer. Basically, connect the subwoofer to the line output (pin jack) terminal(s) of the amplifier. (Refer to pages 4 and 5 for details.) If your amplifier does not have any line output terminal, connect the subwoofer to the speaker output terminals of the amplifier. (Refer to pages 6 and 7 for details.)

Connecting to line output (pin jack) terminals of the amplifier

Connect the main speakers to the speaker output terminals of the amplifier.

- To connect with a YAMAHA DSP amplifier (or AV receiver), connect the SUBWOOFER (or LOW PASS etc.) terminal on the rear of the DSP amplifier (or AV receiver) to the L /MONO INPUT2 terminal of the subwoofer.
- When connecting the subwoofer to the SPLIT SUBWOOFER terminals on the rear of the DSP amplifier, be sure to connect the L /MONO INPUT2 terminal to the “L” side and the R INPUT2 terminal to the “R” side of the SPLIT SUBWOOFER terminals.

■ Using one subwoofer

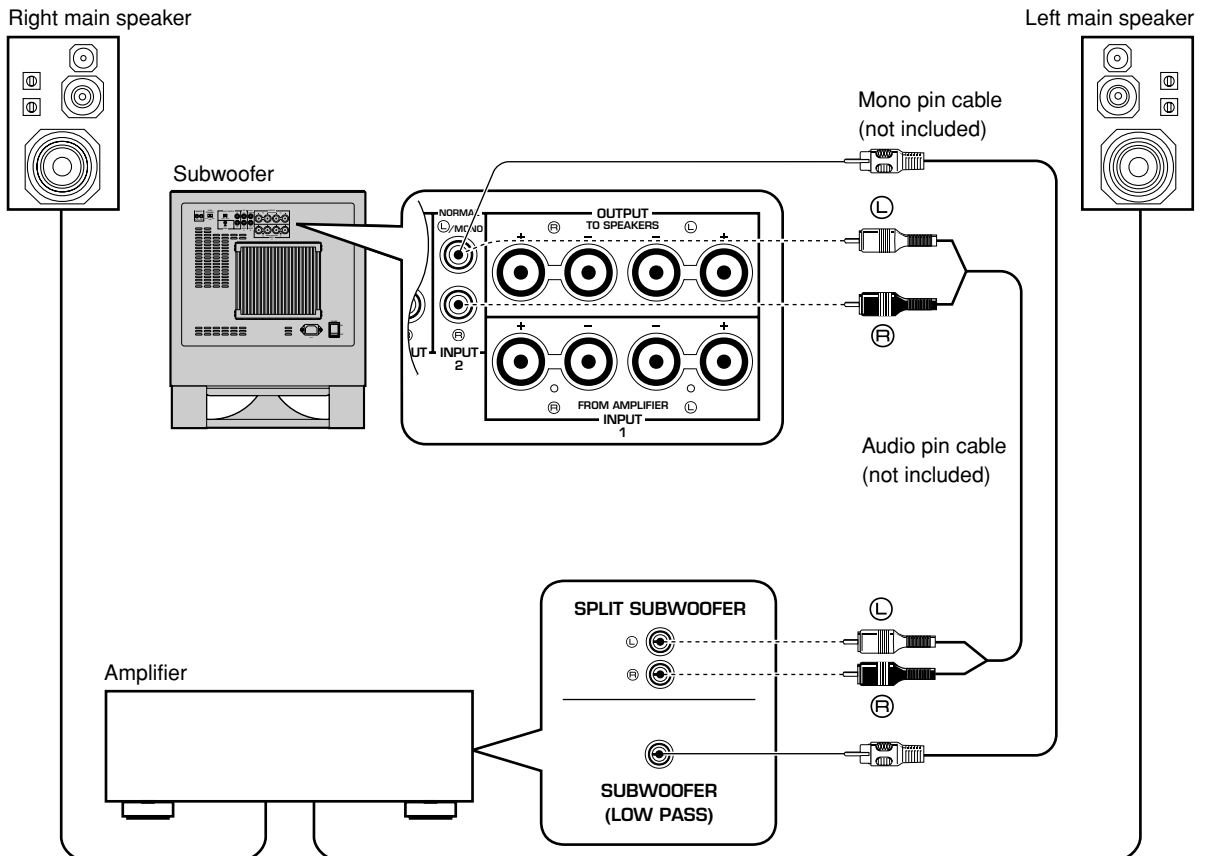

■ Using two subwoofers

Right main speaker

Left main speaker

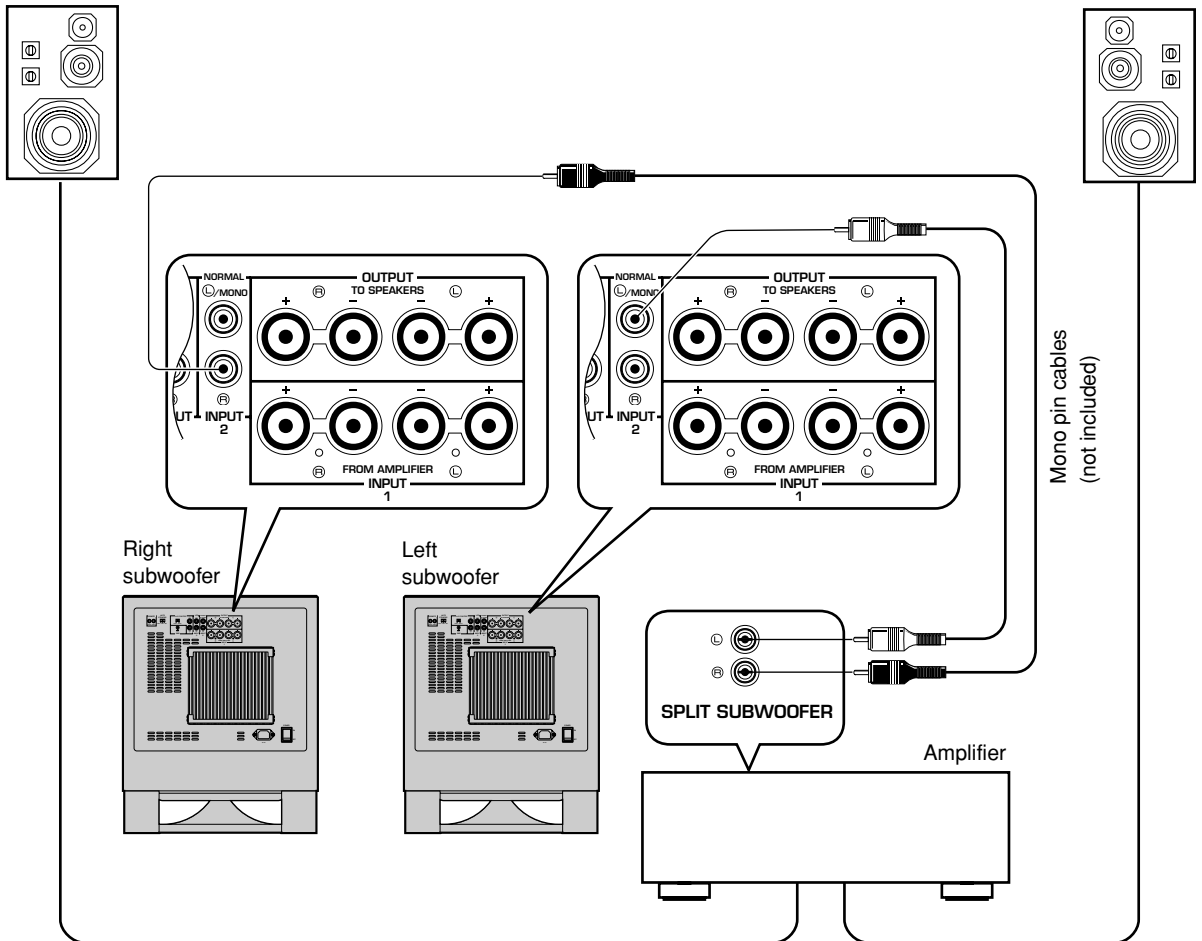

■ Connecting to the LFE (INPUT3) terminal(s)

If your amplifier can cut off high frequencies from the signals for sending to the subwoofer, connect the amplifier to the subwoofer's LFE (INPUT3) terminal(s). This will bring you higher sound quality because the signal routing in the subwoofer is shortened bypassing the built-in HIGH CUT circuit.

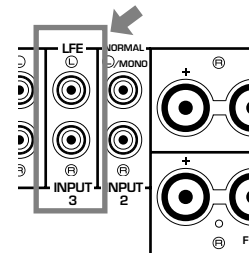

Notes

- Some amplifiers have line output terminals labelled PRE OUT. When you connect the subwoofer to the PRE OUT terminals of the amplifier, make sure that the amplifier has at least two sets of PRE OUT terminals. If the amplifier has only one set of PRE OUT terminals, do not connect the subwoofer to the PRE OUT terminals. Instead, connect the subwoofer to the speaker output terminals of the amplifier. (Refer to pages 6 and 7.)
- When connecting to a monaural line output terminal of the amplifier, connect the L/MONO INPUT2 terminal.
- When connecting to line output terminals of the amplifier, other speakers should not be connected to the OUTPUT terminals on the rear panel of the subwoofer. If connected, they will not produce sound.

Connecting to speaker output terminals of the amplifier

■ Using one subwoofer

If your amplifier has only one set of main speaker output terminals

Connect the speaker output terminals of the amplifier to the INPUT1 terminals of the subwoofer, and connect the OUTPUT terminals of the subwoofer to the main speakers.

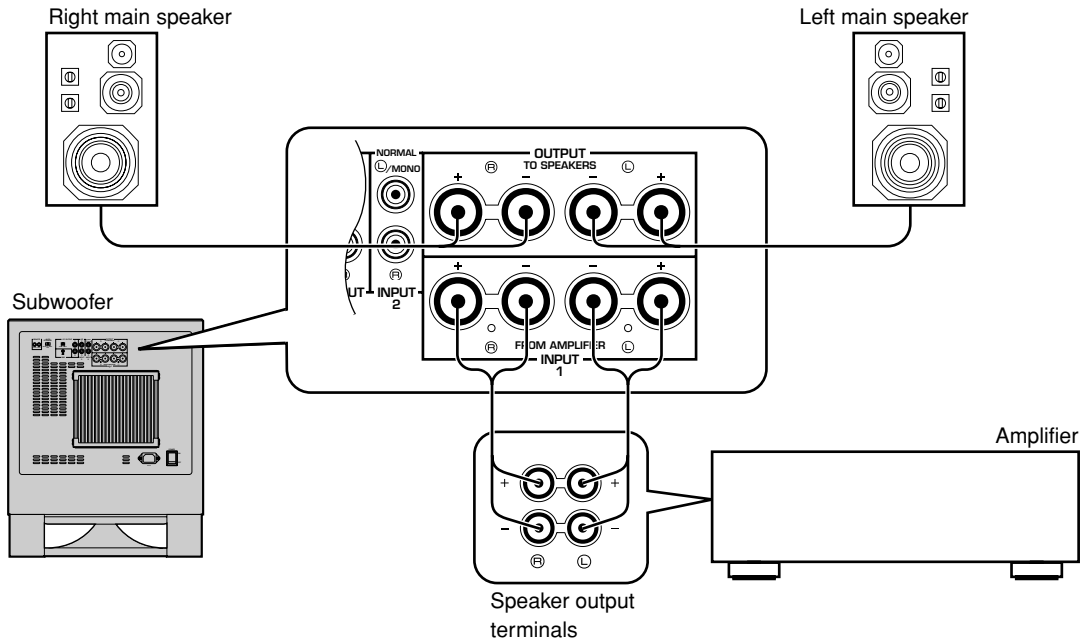

If your amplifier has two sets of speaker output terminals

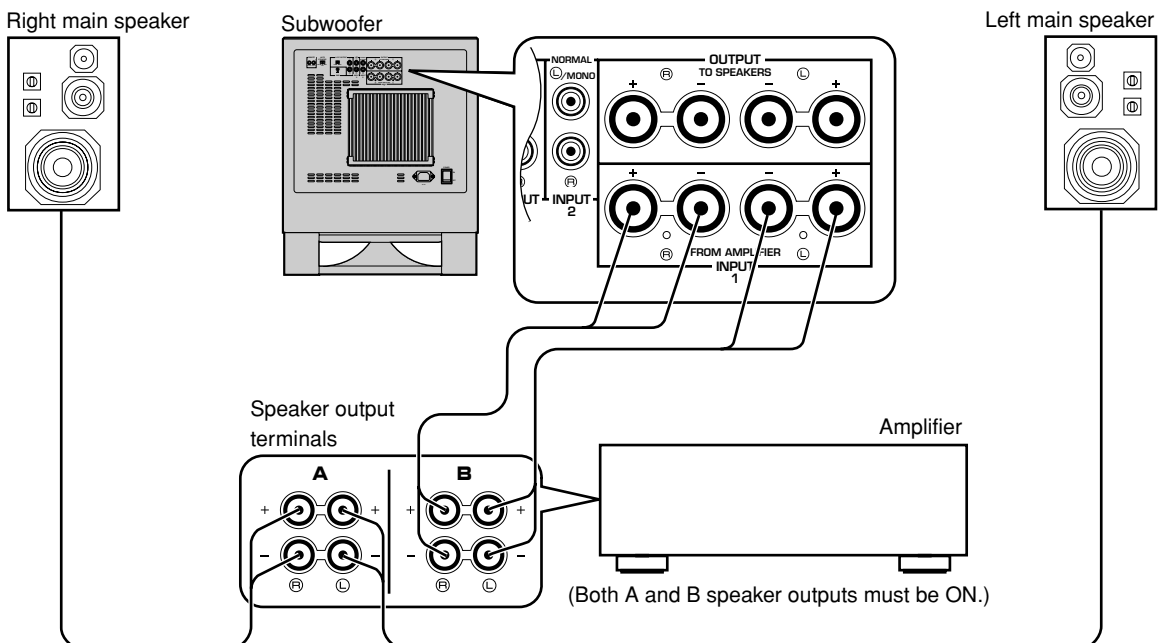

■ Using two subwoofers

Connect the speaker output terminals of the amplifier to the INPUT1 terminals of the subwoofer, and connect the OUTPUT terminals of the subwoofer to the main speakers.

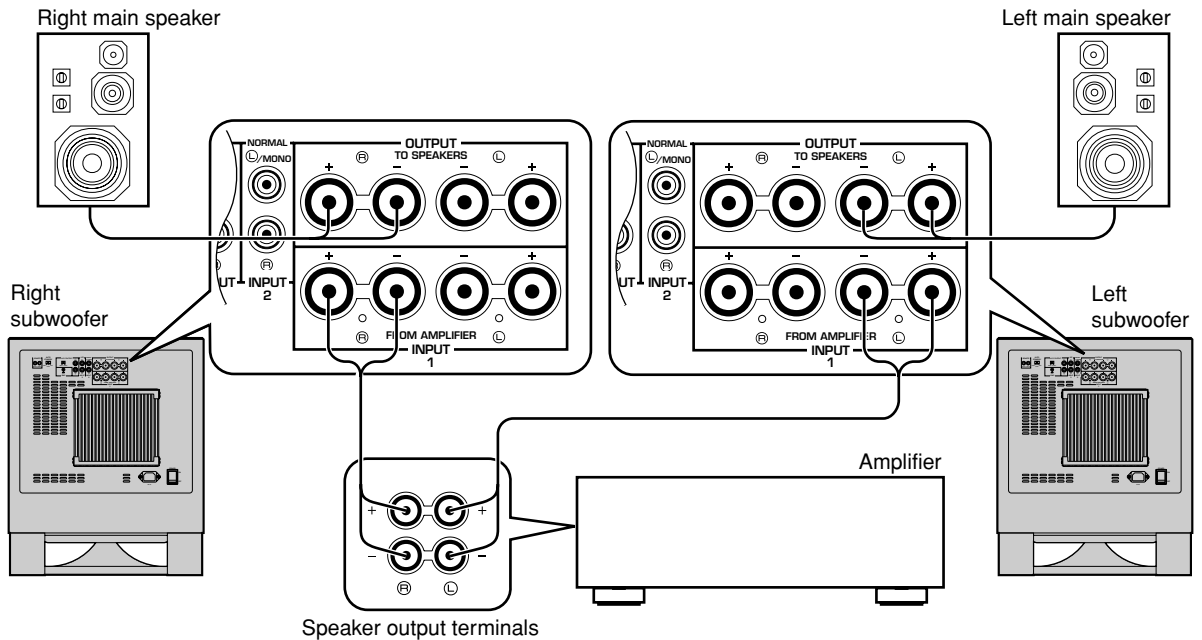

Connecting to the INPUT1/OUTPUT terminals of the subwoofer

For connections, keep the speaker cables as short as possible. Do not bundle or roll up the excess part of the cables. If the connections are faulty, no sound will be heard from the subwoofer or the speakers, or both of them. Make sure that the + and - polarity markings of the speaker cables are observed and set correctly. If these cables are reversed, the sound will be unnatural and lack bass.

How to Connect:

Red: positive (+)
Black: negative (-)

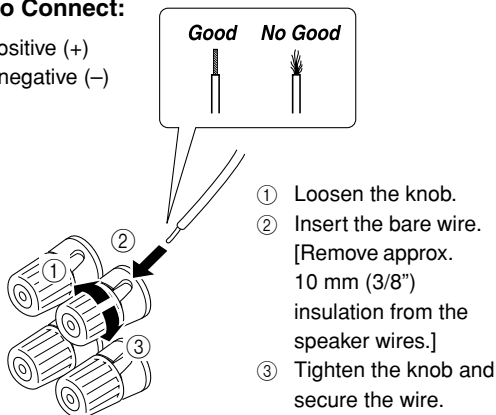

Caution

Do not let the bare speaker wires touch each other as this could damage the subwoofer or the amplifier, or both of them.

<U.S.A., Canada, Australia and Korean models only>

Banana Plug connections are also possible.

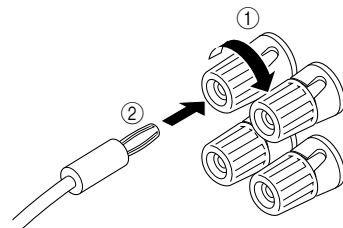

- ① Tighten the terminal knob.
- ② Simply insert the Banana Plug connector into the terminal.

Connecting to H.P.F. OUTPUT terminals

The use of the H.P.F. OUTPUT terminals for connections with the amplifier will improve sound quality of your speaker system. The H.P.F. (High-Pass Filter) OUTPUT terminals of the subwoofer cut off frequencies below the selected frequency point from the input signals, and output high frequencies only. By connecting this terminal with the MAIN IN terminals of the amplifier, the main speakers reproduce high frequencies only.

This will make the whole sound quality clear by preventing sound muddying between the main speakers and the subwoofer.

* This connection can be made if your amplifier has PRE OUT and MAIN IN terminals or you are using separate amplifiers (pre-amplifier and main amplifier).

■ To connect one unit only

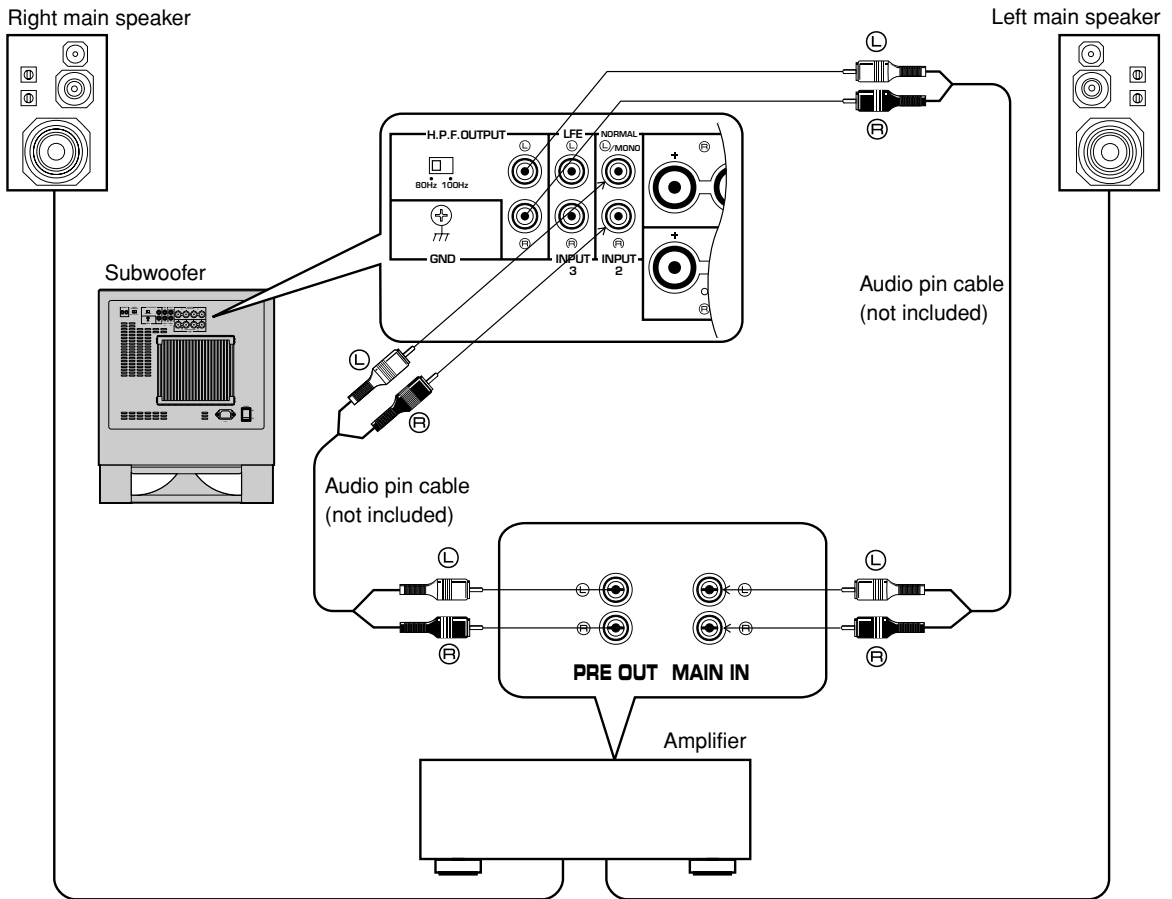

■ To connect two units

Right main speaker

Left main speaker

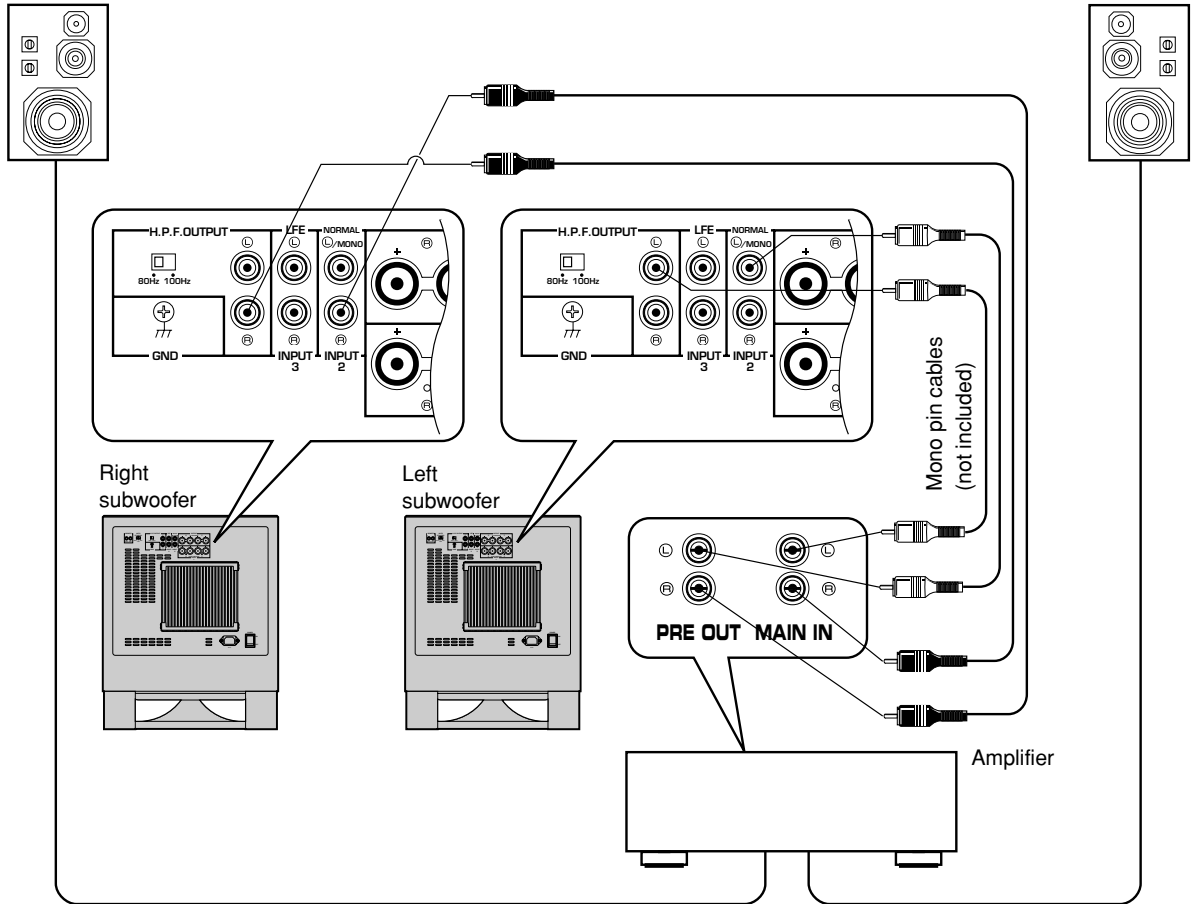

Switching the H.P.F. OUTPUT switch

After the connection is made, select the desired frequency point (80 Hz or 100 Hz) with the **H.P.F. OUTPUT** switch.

(Normally, it is recommended to select the frequency point nearer to the main speakers' minimum reproduceable frequency.)

Frequencies higher than the selected frequency are output from the **H.P.F. OUTPUT** terminals.

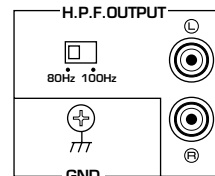

Ground connection

If there is a humming noise when using the subwoofer connected to the speaker terminals, connect the subwoofer and the receiver/amplifier with the grounding cable as shown in Illustration A.

* If there is no ground terminal (GND) on the receiver/amplifier side, connect the cable to a screw that fastens the top cover of the receiver/amplifier to the rear panel as shown in Illustration B.

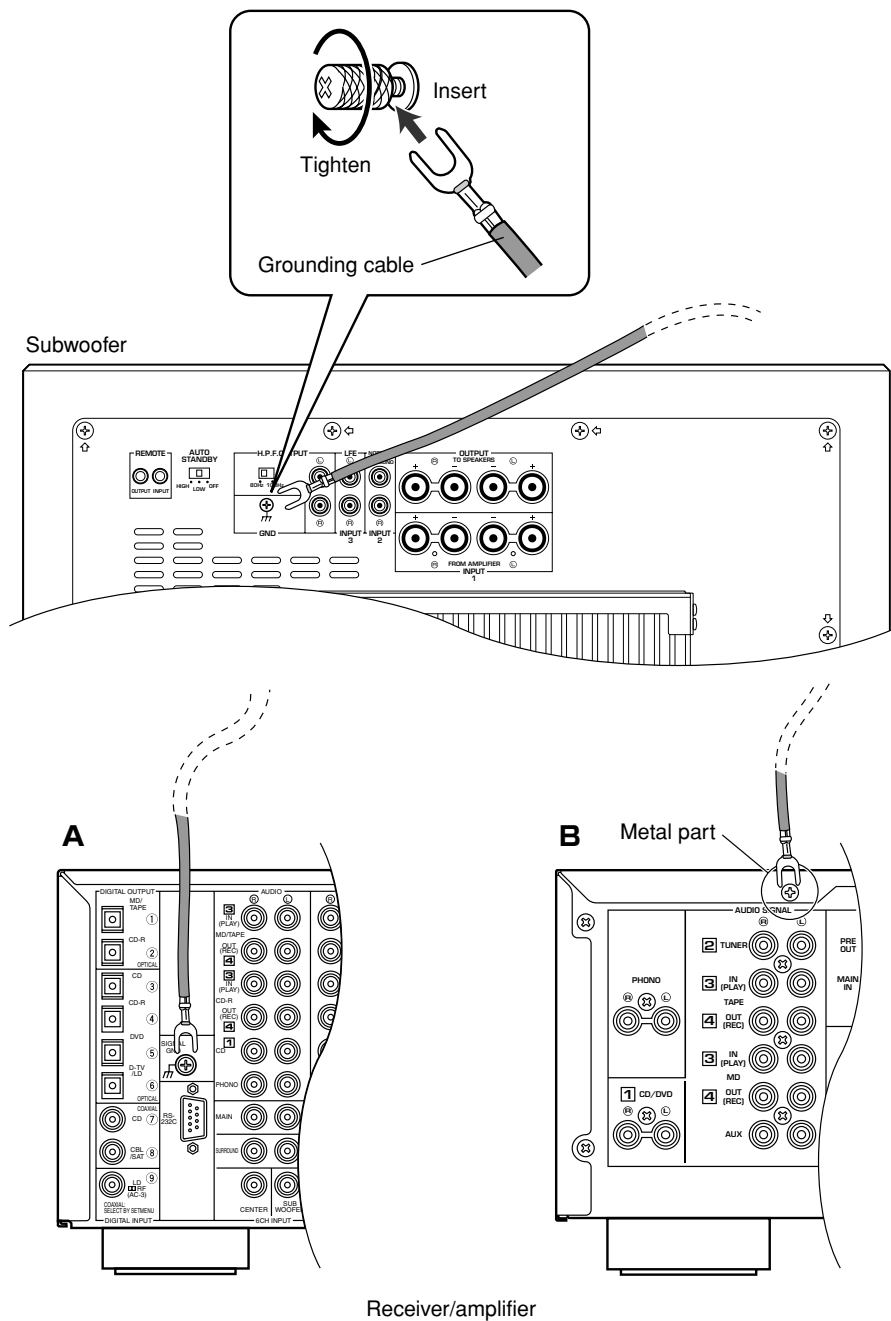

Connecting the AC power cable

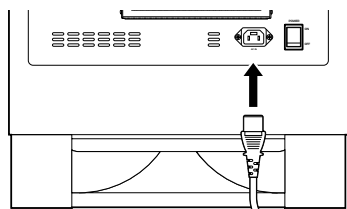

(U.S.A. model) → To AC outlet

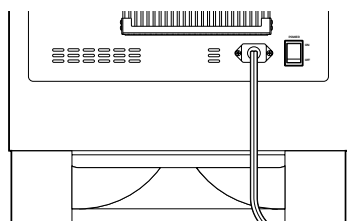

(U.K. model) → To AC outlet

<U.S.A., Canada, Europe and Korean models>

When all connections are completed, plug the included power cable into the AC IN socket of the subwoofer, and then plug in the power cable to the wall outlet.

Notes

- Never connect any power cable other than the included one to the subwoofer. Otherwise, it may result in causing fire or an electrical shock.
- Do not connect the included power cable to any other unit than this subwoofer.

<U.K. and Australia models>

Plug in the subwoofer to the wall outlet.

NOTES ABOUT THE REMOTE CONTROL

Battery installation

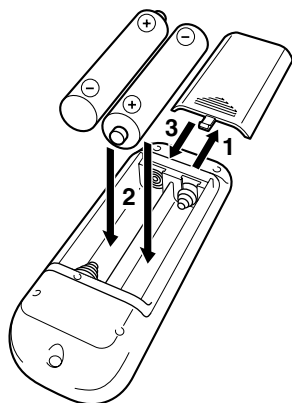

Battery replacement

If you find that the remote control must be used closer to the main unit, the batteries are weak. Replace both batteries with new ones.

Notes

- Use only AA, R6, UM-3 batteries for replacement.
- Be sure the polarities are correct. (See the illustration inside the battery compartment.)
- Remove the batteries if the remote control will not be used for an extended period of time.
- If batteries leak, dispose of them immediately. Avoid touching the leaked material or letting it come in contact with clothing, etc. Clean the battery compartment thoroughly before installing new batteries.

Remote control operation range

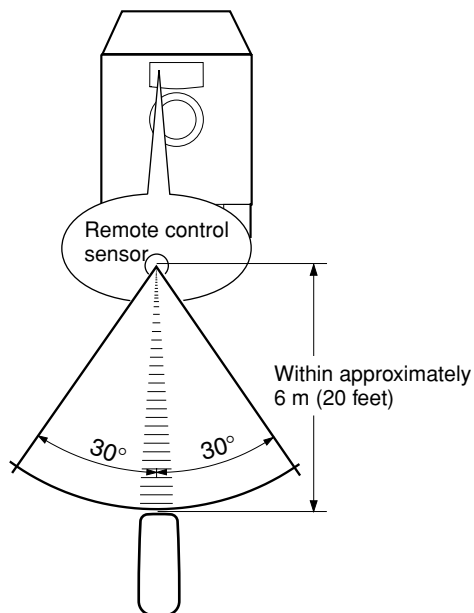

Notes

- There should be no large obstacles between the remote control and the main unit.
- If the remote control sensor is directly illuminated by strong lighting (especially an inverter type of fluorescent lamp etc.), it might cause the remote control not to work correctly. In this case, reposition the main unit to avoid direct lighting.

CONTROLS AND THEIR FUNCTIONS

Front panel

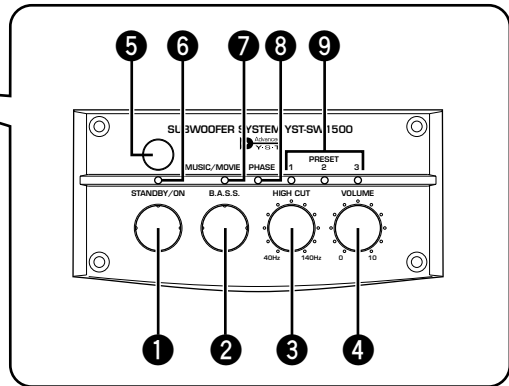
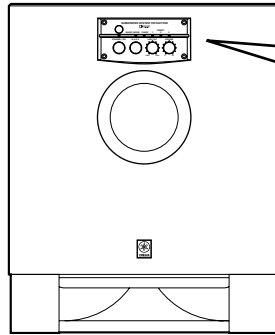

Rear panel

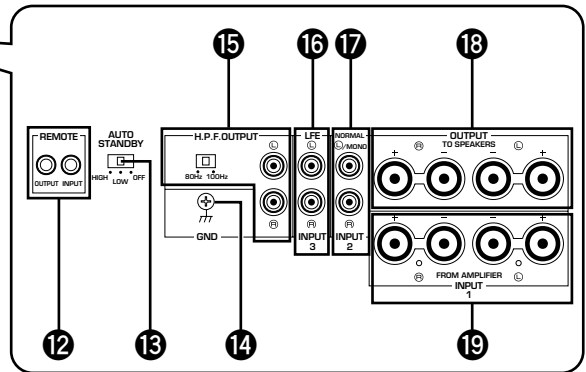
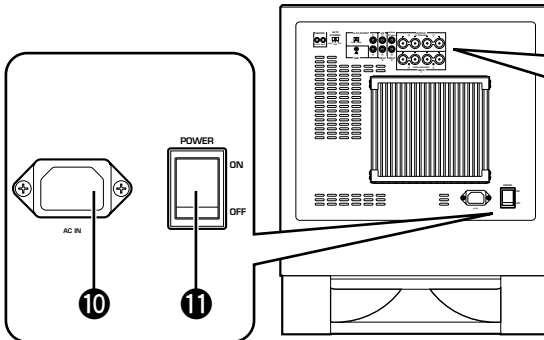

Remote control

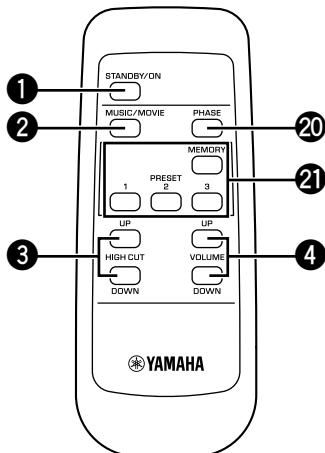

- STANDBY/ON button**
 Press this button to turn on the power. Press again to set the subwoofer in the standby mode.
 * This button can be used only when the **POWER** (11) switch is set in the ON position.

Standby mode

The subwoofer is still using a small amount of power in this mode.

- B.A.S.S. switch**
MUSIC/MOVIE button
 By pressing this switch to select the MOVIE mode, the bass sound in video software is faithfully reproduced. By pressing this switch to select the MUSIC mode, the bass sound in audio software is well reproduced.
- HIGH CUT control**
HIGH CUT UP/DOWN buttons
 Select the upper limit of the frequencies to be reproduced by the subwoofer.
 To adjust the control on the front panel, put a coin, etc. in the groove in the control and turn it.

- 4 VOLUME control**
VOLUME UP/DOWN buttons
 Adjust the volume level. Turn the control clockwise or press the **UP** button to increase the volume.
 Turn the control counterclockwise or press the **DOWN** button to decrease the volume.
 To adjust the control on the front panel, put a coin, etc. in the groove on the control and turn it.
- 5 Remote control sensor**
 Receives signals from the remote control.
- 6 Power indicator (LED)**
 Lights up in green while the subwoofer is turned on.
 Lights up in red when the subwoofer is turned into the standby mode by the automatic power-switching function.
- 7 MUSIC/MOVIE indicator (LED)**
 Lights up in red when the MUSIC mode is selected, and in green when the MOVIE mode is selected.
- 8 PHASE indicator (LED)**
 Lights up in red when the **PHASE** button (20) is set in the regular mode, and in green when it is set in the reverse mode.
- 9 PRESET 1/2/3 indicators (LED)**
 Show which PRESET number (1, 2 or 3) is selected.
 (If the subwoofer is turned into the standby mode when one of these indicators are illuminated, no indicator will light up next time the subwoofer is turned on.)
- 10 AC IN**
<U.S.A., Canada, Europe and Korean models only>
 Plug the included power cable into this socket. Never connect a power cable other than the included one to this socket. Also, never connect the included power cable to another unit.
- 11 POWER switch**
 Normally, set this switch to the ON position to use the subwoofer. In this state, you can turn on the subwoofer or turn the subwoofer into the standby mode by pressing the **STANDBY/ON** (1) button. Set this switch to the OFF position to completely cut off the subwoofer's power supply from the AC line.
- 12 REMOTE terminals**
 These terminals are used for custom installation system. When the subwoofer is connected to the components for custom installation system, you can operate the subwoofer with the system remote control.
- 13 AUTO STANDBY (HIGH/LOW/OFF) switch**
 This switch is originally set to the OFF position. By setting this switch to the HIGH or LOW position, the subwoofer's automatic power-switching function operates as described on page 14. If you do not need this function, leave this switch in the OFF position.
- 14 GND terminal**
 Connecting this terminal to ground (GND) terminal of the receiver/amplifier can reduce a humming noise. (See page 10.)
- 15 H.P.F. (High Pass Filter) OUTPUT switch**
 Selects the upper limit of the frequencies to be cut off from the signals outputted at the H.P.F. OUTPUT terminals. Use this switch only when the H.P.F. OUTPUT terminals are used for connecting with the amplifier. (See page 8 for details)
- H.P.F. OUTPUT terminals**
 These terminals cut off frequencies below the frequency point selected by the H.P.F. OUTPUT switch from the input signals and output higher frequencies.
- 16 INPUT3 (LFE) terminals**
 The **HIGH CUT** control (3) has no effect on the signals inputted to these terminals. (See page 5 for details)
- 17 INPUT2 terminals**
 Used to input line level signals from the amplifier. (Refer to "**CONNECTIONS**" for details.)
- 18 OUTPUT (TO SPEAKERS) terminals**
 Can be used for connecting to the main speakers. Signals are sent directly from the amplifier to the main speakers by way of these terminals. (Refer to "**CONNECTIONS**" for details.)
- 19 INPUT1 (FROM AMPLIFIER) terminals**
 Used to connect the subwoofer with the speaker terminals of the amplifier. (Refer to "**CONNECTIONS**" for details.)
- 20 PHASE button**
 Normally press this button to select the reverse mode. However, according to your speaker systems or the listening condition, there may be a case when better sound quality is obtained by selecting the regular mode. Select the better mode by monitoring the sound. In the reverse mode, the PHASE indicator on the front panel lights up in green, and in the regular mode, it lights up in red.
- 21 MEMORY button/PRESET buttons**
 Used to store and recall the data for the **B.A.S.S.** [**MUSIC/MOVIE**] (2), the **VOLUME [VOLUME UP/DOWN]** (4), the **HIGH CUT [HIGH CUT UP/DOWN]** (3) and the **PHASE** (20) adjustments. (See page 16.)

AUTOMATIC POWER-SWITCHING FUNCTION

If the source being played is stopped and the input signal is cut off for 7 to 8 minutes, the subwoofer automatically switches to the standby mode. (When the subwoofer switches to the standby mode by the automatic power-switching function, the power indicator lights up in red.) When you play a source again, the power of the subwoofer turns on automatically by sensing audio signals input to the subwoofer.

This function operates by sensing a certain level of low frequency input signal. Usually set the **AUTO STANDBY** switch to the LOW position. However, if the power is not switched to ON or STANDBY smoothly, set the switch to the HIGH position. In the HIGH position, the power will turn on even with a low level of input signal. But please be aware that the subwoofer may not switch to the standby mode when there is an extremely low input signal.

- * The power might turn on unexpectedly by sensing noise from other appliances. If that occurs, set the **AUTO STANDBY** switch to the OFF position.
- * This function detects the low-frequency components below 200 Hz of the input signals (i.e., the explosion in the action movie, the sound of the bass guitar or the bass drum, etc.).
- * The minutes required to switch the subwoofer to the standby mode might change by sensing noise from other appliances.

This function is available only when the power of the subwoofer is on (by setting the STANDBY/ON button to "ON").

This function will not work if the subwoofer is turned into the standby mode by using the STANDBY/ON button. (The power indicator on the front panel goes off.)

ADJUSTING THE SUBWOOFER BEFORE USE

Before using the subwoofer, adjust the subwoofer to obtain the optimum volume and tone balance between the subwoofer and the main speakers by following the procedures described below.

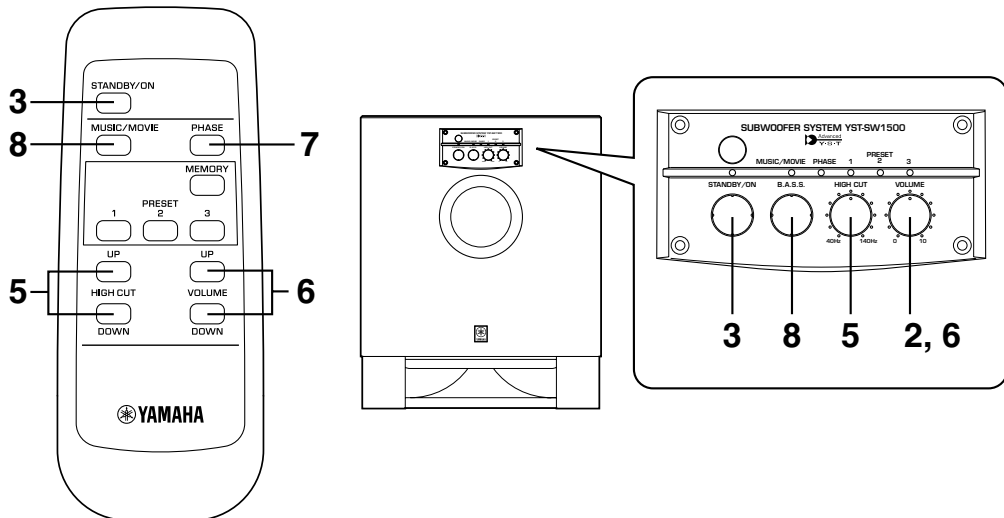

- 1** Set the volume level on the amplifier to minimum, and turn on the amplifier and other components.
 - 2** Turn the **VOLUME** control to set the control to minimum (0).
 - 3** Make sure that the **POWER** switch on the rear panel is set to the ON position, then press the **STANDBY/ON** button to turn on the subwoofer.
 - * The power indicator lights up in green.
 - 4** Play a source containing low-frequency components and adjust the amplifier's volume control to the desired listening level.
 - 5** Turn the **HIGH CUT** control (or press the **HIGH CUT UP/DOWN** buttons on the remote control) to set the control to the position where the desired response can be obtained.
- Normally, set the control to the main speaker's rated minimum reproducible frequency*.
- * The main speaker's rated minimum reproducible frequency can be looked up in the speakers' catalog or owner's manual.
- 6** Increase the volume gradually to adjust the volume balance between the subwoofer and the main speakers.

Normally, set the control to the level where you can obtain a little more bass effect than when the subwoofer is not used. If the desired response cannot be obtained, adjust the HIGH CUT control and the VOLUME control again.

- 7** Press the **PHASE** button to select the regular or reverse mode which gives you the better bass sound.
- Normally, select the reverse mode (so that the PHASE indicator on the front panel lights up in green). If the desired response cannot be obtained, select the regular mode (so that the PHASE indicator lights up in red).
- 8** Select "MOVIE" or "MUSIC" according to the played source.

MOVIE (when the MUSIC/MOVIE indicator on the front panel lights up in green):

When a movie type source is played, the low-frequency effects are enhanced to allow the listener enjoy more powerful sound. (The sound will be thicker and deeper.)

MUSIC (when the MUSIC/MOVIE indicator on the front panel lights up in red):

When an ordinary music source is played, the excessive low-frequency components are cut off to make the sound clearer. (The sound will be lighter and reproduces the melody line more clearly.)

- **Once the volume balance between the subwoofer and the main speakers is adjusted, you can adjust the volume of your whole sound system by using the amplifier's volume control.**

However, if you change the main speakers to others, you must make this adjustment again.

- **For adjusting the VOLUME control, the HIGH CUT control and the PHASE button, refer to "Frequency characteristics" on page 17.**

Storing preset data of the VOLUME control etc.

You can store preset data of the **VOLUME** control, the **HIGH CUT** control, the **PHASE** button and the **B.A.S.S.** switch as a set. Each of the three **PRESET** buttons on the remote control is used to store (and recall) one set of data. With this function, you can recall any preset data easily according to the source.

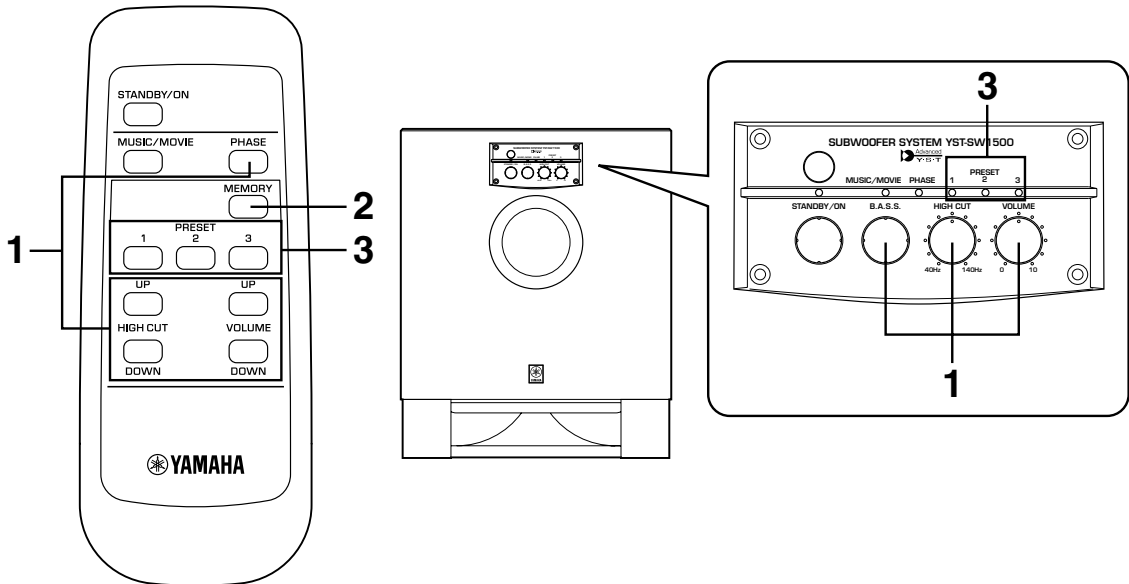

■ To store

- 1** Adjust the **VOLUME** control, the **HIGH CUT** control, the **PHASE** button and the **B.A.S.S.** switch.
- 2** Press the **MEMORY** button. The **PRESET** number indicators on the front panel flash.
- 3** Press the **PRESET 1** button. The corresponding PRESET number indicator illuminates. This shows that the data has been stored in **PRESET 1**.

* In the same way, store other sets of data in **PRESET 2** and **3**.

* The default setting of each **PRESET** button is suitable for using the following Yamaha speaker system with this subwoofer.

PRESET 1: NS-8HX, NS-6HX

PRESET 2: NS-4HX

PRESET 3: NS-2HX

Notes

- A new setting can be stored in place of the former one.
- While the **VOLUME** control or the **HIGH CUT** control is rotating from a **PRESET** button having been pressed, pressing another **PRESET** button is ineffective.

Memory back-up

The memory back-up circuit prevents the stored data from being lost even if the **POWER** switch is set off or the power plug is disconnected from the AC outlet or the power is cut due to temporary power failure. If, however, the power is lost for more than one week, the memory may be erased. If so, it can be re-stored by simply following the steps described above.

Frequency characteristics

This subwoofer's frequency characteristics

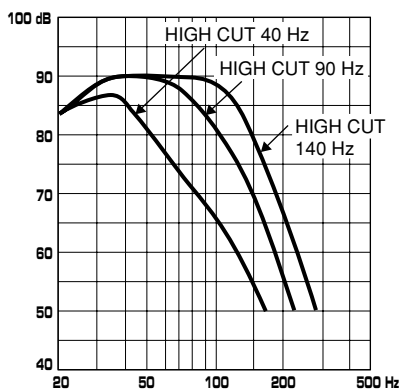

The figures below show the optimum adjustment of each control and the frequency characteristics when this subwoofer is combined with a typical main speaker system.

EX.1 When combined with a 4" or 5" (10 cm or 13 cm) acoustic suspension, 2 way system main speakers

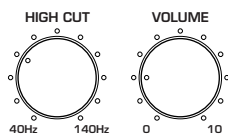

PHASE—Set to the reverse mode.
B.A.S.S.—MOVIE

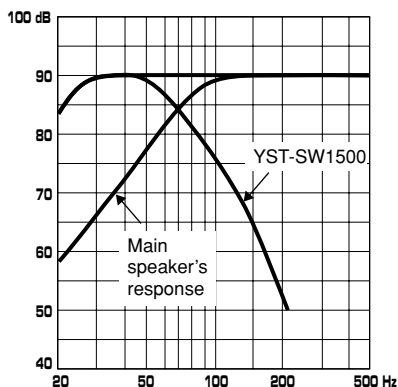

EX.2 When combined with an 8" or 10" (20 cm or 25 cm) acoustic suspension, 2 way system main speakers

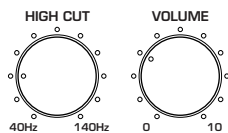

PHASE—Set to the reverse mode.
B.A.S.S.—MOVIE

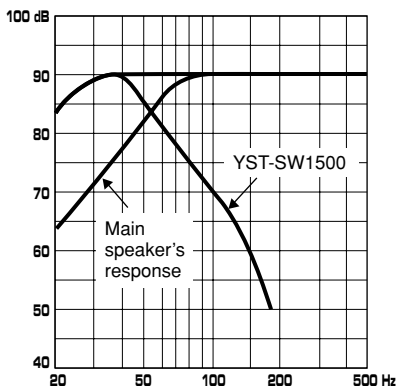

ADVANCED YAMAHA ACTIVE SERVO TECHNOLOGY

The theory of Yamaha Active Servo Technology has been based upon two major factors, the Helmholtz resonator and negative-impedance drive. Active Servo Processing speakers reproduce the bass frequencies through an “air woofer”, which is a port or opening in the speaker’s cabinet. This opening is used instead of, and performs the functions of, a woofer in a conventionally designed speaker system. Thus, signals of low amplitude within the cabinet can, according to the Helmholtz resonance theory, be outputted from this opening as waves of great amplitude if the size of the opening and the volume of the cabinet are in the correct proportion to satisfy a certain ratio.

In order to accomplish this, moreover, the amplitudes within the cabinet must be both precise and of sufficient power because these amplitudes must overcome the “load” presented by the air that exists within the cabinet.

Thus it is this problem that is resolved through the employment of a new design in which the amplifier supplies special signals. If the electrical resistance of the voice coil could be reduced to zero, the movement of the speaker unit would become linear with respect to signal voltage. To accomplish this, a special negative-impedance output-drive amplifier for subtracting output impedance of the amplifier is used.

By employing negative-impedance drive circuits, the amplifier is able to generate precise, low-amplitude, low-frequency waves with superior damping characteristics. These waves are then radiated from the cabinet opening as high-amplitude signals. The system can, therefore, by employing the negative-impedance output drive amplifier and a speaker cabinet with the Helmholtz resonator, reproduce an extremely wide range of frequencies with amazing sound quality and less distortion.

The features described above, then, are combined to be the fundamental structure of the conventional Yamaha Active Servo Technology.

Our new Active Servo Technology — Advanced Yamaha Active Servo Technology — adopted Advanced Negative Impedance Converter (ANIC) circuits, which allows the conventional negative impedance converter to dynamically vary in order to select an optimum value for speaker impedance variation. With this new ANIC circuits, Advanced Yamaha Active Servo Technology can provide more stable performance and improved sound pressure compared with the conventional Yamaha Active Servo Technology, resulting in more natural and dynamic bass reproduction.

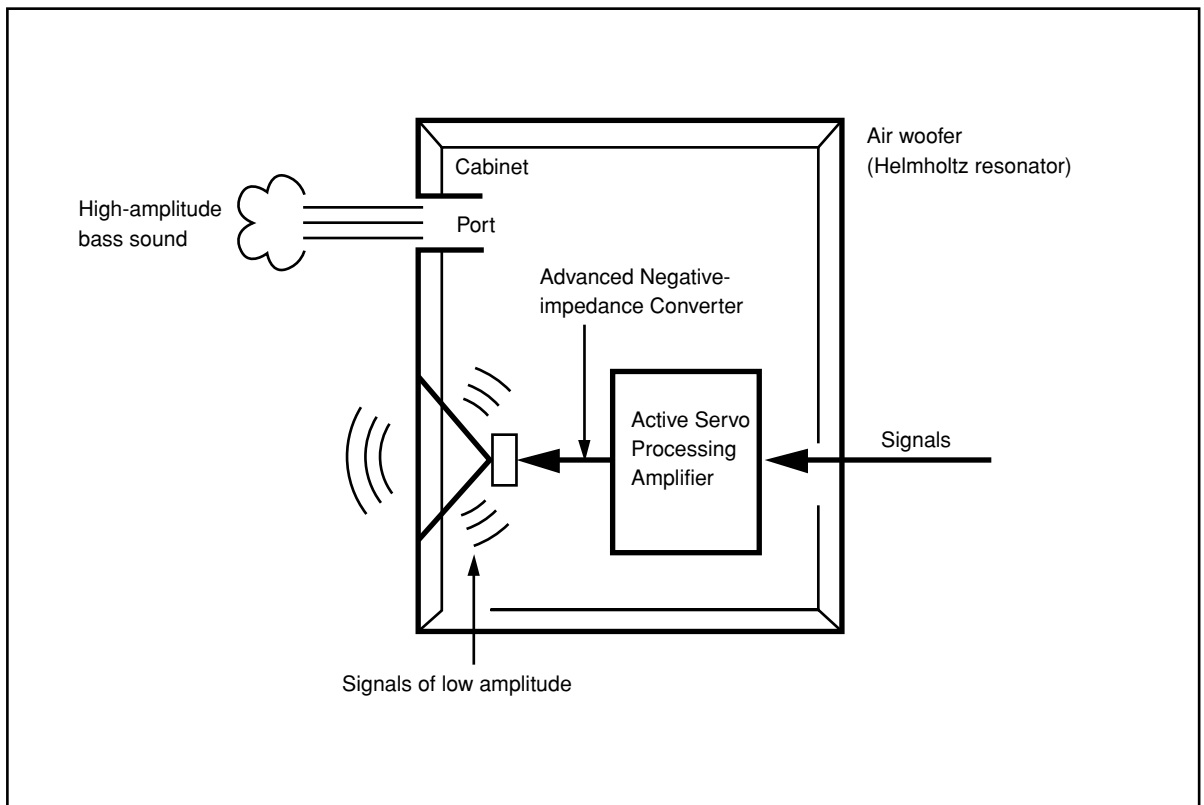

TROUBLESHOOTING

Refer to the chart below when this unit does not function properly. If the problem you are experiencing is not listed below or if the instructions given below do not help, disconnect the power cable and contact your authorized YAMAHA dealer or service center.

Problem	Cause	What to Do
Power is not supplied even though the STANDBY/ON button is set to the ON position.	The power cable is not plugged in, or the POWER switch is set to the OFF position.	Connect the power cable to both the AC IN socket of the subwoofer and an AC outlet securely, or set the POWER switch to the ON position.
No sound.	The volume is set to minimum.	Raise the volume up.
	Speaker cables are not connected securely.	Connect them securely.
Sound level is too low.	Speaker cables are not connected correctly.	Connect them correctly, that is L (left) to L, R (right) to R, "+" to "+" and "-" to "-".
	Setting of the PHASE is not proper.	Set the PHASE to the another mode.
	A source sound with few bass frequencies is played.	Play a source sound with bass frequencies. Set the HIGH CUT control to a higher position.
	It is influenced by standing waves.	Reposition the subwoofer or break up the parallel surface by placing bookshelves etc. along the walls.
The subwoofer does not turn on automatically.	The POWER switch is set to the OFF position.	Set the POWER switch to the ON position.
	The subwoofer is set to the standby mode by pressing the STANDBY/ON button. (The power indicator is not illuminated.)	Turn on the subwoofer again by pressing the STANDBY/ON button.
	The AUTO STANDBY switch is set to the OFF position.	Set the AUTO STANDBY switch to the "HIGH" or "LOW" position.
	The level of input signal is too low.	Set the AUTO STANDBY switch to the "HIGH" position.
The subwoofer turns into the standby mode unexpectedly.	The level of input signal is too low.	Set the AUTO STANDBY switch to the "HIGH" position.
The subwoofer turns on unexpectedly.	There is an influence of noise generated from external appliances etc.	Move the subwoofer farther away from such appliances and/or reposition the connected speaker cables. Otherwise, set the AUTO STANDBY switch to the "OFF" position.
The household breaker goes off.	The subwoofer consumes much electricity when a high level signal is inputted to the subwoofer.	Turn down the volume on the amplifier etc. connected to the subwoofer or cut off the power to other unused equipment.
The remote control does not work.	Direct sunlight or lighting (of an inverter type of fluorescent lamp etc.) is striking the remote control sensor of the main unit.	Change position of the main unit.
The distance or range within which the remote control can be used decreases.	The batteries of this remote control are too weak.	Replace the batteries with new ones.

Note

When an excessive level of signal is inputted to the subwoofer for 5 to 15 minutes, the power indicator begins flashing to alarm you of the danger of damaging the power amplifier and speaker in this subwoofer system. If the signal input lasts for 5 minutes more, the subwoofer turns into the standby mode automatically .

SPECIFICATIONS

Type Advanced Yamaha Active Servo Technology

Power Consumption 250W

Driver 30 cm (12") cone woofer
Magnetic shielding type

Standby Power Consumption 1.0W

Amplifier Output 1 kW/5Ω

Dimensions (W x H x D) 420 mm x 511 mm x 448 mm
(16-9/16" x 20-1/8" x 17-5/8")

Frequency Response 16 Hz–160 Hz (–10 dB)

Weight 29 kg (63 lbs. 15 oz.)

Power Supply

U.S.A. and Canada models AC 120V, 60 Hz

U.K. and Europe models AC 230V, 50 Hz

Australia model AC 240V, 50 Hz

Korean model AC 220V, 50 Hz

* Please note that all specifications are subject to change without notice.

