



*Portable Grand*  
**DGX-660**

**Owner's Manual**

Setting Up

Basic Guide

Reference

Appendix

**Thank you for purchasing this Yamaha Digital Piano!**

We recommend that you read this manual carefully so that you can fully take advantage of the advanced and convenient functions of the instrument. We also recommend that you keep this manual in a safe and handy place for future reference.

Before using the instrument, be sure to read "PRECAUTIONS" on pages 5–6.

**Keyboard Stand Assembly**

For information on assembling the keyboard stand, refer to the instructions on **page 12** of this manual.

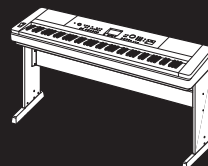

## SPECIAL MESSAGE SECTION

This product utilizes batteries or an external power supply (adapter). DO NOT connect this product to any power supply or adapter other than one described in the manual, on the name plate, or specifically recommended by Yamaha.

**WARNING:** Do not place this product in a position where anyone could walk on, trip over, or roll anything over power or connecting cords of any kind. The use of an extension cord is not recommended! If you must use an extension cord, the minimum wire size for a 25' cord (or less) is 18 AWG. NOTE: The smaller the AWG number, the larger the current handling capacity. For longer extension cords, consult a local electrician.

This product should be used only with the components supplied or; a cart, rack, or stand that is recommended by Yamaha. If a cart, etc., is used, please observe all safety markings and instructions that accompany the accessory product.

### SPECIFICATIONS SUBJECT TO CHANGE:

The information contained in this manual is believed to be correct at the time of printing. However, Yamaha reserves the right to change or modify any of the specifications without notice or obligation to update existing units.

This product, either alone or in combination with an amplifier and headphones or speaker/s, may be capable of producing sound levels that could cause permanent hearing loss. DO NOT operate for long periods of time at a high volume level or at a level that is uncomfortable. If you experience any hearing loss or ringing in the ears, you should consult an audiologist.

**IMPORTANT:** The louder the sound, the shorter the time period before damage occurs.

Some Yamaha products may have benches and / or accessory mounting fixtures that are either supplied with the product or as optional accessories. Some of these items are designed to be dealer assembled or installed. Please make sure that benches are stable and any optional fixtures (where applicable) are well secured BEFORE using.

Benches supplied by Yamaha are designed for seating only. No other uses are recommended.

### NOTICE:

Service charges incurred due to a lack of knowledge relating to how a function or effect works (when the unit is operating as designed) are not covered by the manufacturer's warranty, and are therefore the owners responsibility. Please study this manual carefully and consult your dealer before requesting service.

### ENVIRONMENTAL ISSUES:

Yamaha strives to produce products that are both user safe and environmentally friendly. We sincerely believe that our products and the production methods used to produce them, meet these goals. In keeping with both the letter and the spirit of the law, we want you to be aware of the following:

#### Battery Notice:

This product MAY contain a small non-rechargeable battery which (if applicable) is soldered in place. The average life span of this type of battery is approximately five years. When replacement becomes necessary, contact a qualified service representative to perform the replacement.

This product may also use "household" type batteries. Some of these may be rechargeable. Make sure that the battery being charged is a rechargeable type and that the charger is intended for the battery being charged.

When installing batteries, never mix old batteries with new ones, and never mix different types of batteries. Batteries MUST be installed correctly. Mismatches or incorrect installation may result in overheating and battery case rupture.

#### Warning:

Do not attempt to disassemble, or incinerate any battery. Keep all batteries away from children. Dispose of used batteries promptly and as regulated by the laws in your area. Note: Check with any retailer of household type batteries in your area for battery disposal information.

#### Disposal Notice:

Should this product become damaged beyond repair, or for some reason its useful life is considered to be at an end, please observe all local, state, and federal regulations that relate to the disposal of products that contain lead, batteries, plastics, etc. If your dealer is unable to assist you, please contact Yamaha directly.

#### NAME PLATE LOCATION:

The name plate is located on the bottom of the product. The model number, serial number, power requirements, etc., are located on this plate. You should record the model number, serial number, and the date of purchase in the spaces provided below and retain this manual as a permanent record of your purchase.

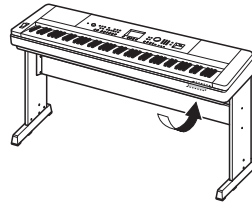

Model

---

Serial No.

---

Purchase Date

---

## PLEASE KEEP THIS MANUAL

## For DGX-660

### COMPLIANCE INFORMATION STATEMENT (DECLARATION OF CONFORMITY PROCEDURE)

Responsible Party : Yamaha Corporation of America  
Address : 6600 Orangethorpe Ave., Buena Park, Calif. 90620  
Telephone : 714-522-9011  
Type of Equipment : Digital Piano  
Model Name : DGX-660

This device complies with Part 15 of the FCC Rules.  
Operation is subject to the following two conditions:  
1) this device may not cause harmful interference, and  
2) this device must accept any interference received including interference that may cause undesired operation.  
See user manual instructions if interference to radio reception is suspected.

\* This applies only to products distributed by YAMAHA CORPORATION OF AMERICA.

(FCC DoC)

## For AC adaptor and DGX-660

### FCC INFORMATION (U.S.A.)

**1. IMPORTANT NOTICE: DO NOT MODIFY THIS UNIT!**

This product, when installed as indicated in the instructions contained in this manual, meets FCC requirements. Modifications not expressly approved by Yamaha may void your authority, granted by the FCC, to use the product.

**2. IMPORTANT:** When connecting this product to accessories and/or another product use only high quality shielded cables. Cable/s supplied with this product **MUST** be used. Follow all installation instructions. Failure to follow instructions could void your FCC authorization to use this product in the USA.

**3. NOTE:** This product has been tested and found to comply with the requirements listed in FCC Regulations, Part 15 for Class "B" digital devices. Compliance with these requirements provides a reasonable level of assurance that your use of this product in a residential environment will not result in harmful interference with other electronic devices. This equipment generates/uses radio frequencies and, if not installed and used according to the instructions found in the users manual, may cause interference harmful to the operation of other electronic devices. Compliance with FCC regulations does not guarantee

that interference will not occur in all installations. If this product is found to be the source of interference, which can be determined by turning the unit "OFF" and "ON", please try to eliminate the problem by using one of the following measures:

Relocate either this product or the device that is being affected by the interference.

Utilize power outlets that are on different branch (circuit breaker or fuse) circuits or install AC line filter/s.

In the case of radio or TV interference, relocate/reorient the antenna. If the antenna lead-in is 300 ohm ribbon lead, change the lead-in to co-axial type cable.

If these corrective measures do not produce satisfactory results, please contact the local retailer authorized to distribute this type of product. If you can not locate the appropriate retailer, please contact Yamaha Corporation of America, Electronic Service Division, 6600 Orangethorpe Ave, Buena Park, CA90620

The above statements apply **ONLY** to those products distributed by Yamaha Corporation of America or its subsidiaries.

\* This applies only to products distributed by YAMAHA CORPORATION OF AMERICA.

(class B)

## For AC adaptor

This device complies with Part 15 of the FCC Rules. Operation is subject to the following two conditions: (1) this device may not cause harmful interference, and (2) this device must accept any interference received, including interference that may cause undesired operation.

(fcc\_sengen)

### CAN ICES-3 (B)/NMB-3(B)

- This applies only to products distributed by Yamaha Canada Music Ltd.
- Ceci ne s'applique qu'aux produits distribués par Yamaha Canada Musique Ltée.  
(can\_b\_01)

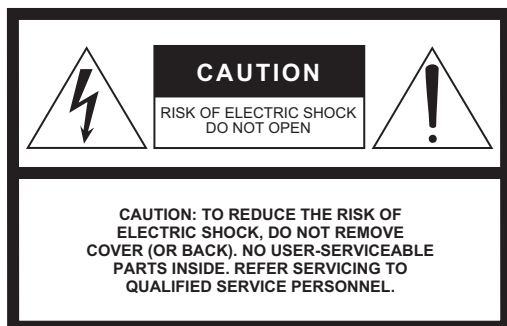

### Explanation of Graphical Symbols



The lightning flash with arrowhead symbol within an equilateral triangle is intended to alert the user to the presence of uninsulated “dangerous voltage” within the product’s enclosure that may be of sufficient magnitude to constitute a risk of electric shock to persons.



The exclamation point within an equilateral triangle is intended to alert the user to the presence of important operating and maintenance (servicing) instructions in the literature accompanying the product.

## IMPORTANT SAFETY INSTRUCTIONS

- 1 Read these instructions.
- 2 Keep these instructions.
- 3 Heed all warnings.
- 4 Follow all instructions.
- 5 Do not use this apparatus near water.
- 6 Clean only with dry cloth.
- 7 Do not block any ventilation openings. Install in accordance with the manufacturer’s instructions.
- 8 Do not install near any heat sources such as radiators, heat registers, stoves, or other apparatus (including amplifiers) that produce heat.
- 9 Do not defeat the safety purpose of the polarized or grounding-type plug. A polarized plug has two blades with one wider than the other. A grounding type plug has two blades and a third grounding prong. The wide blade or the third prong are provided for your safety. If the provided plug does not fit into your outlet, consult an electrician for replacement of the obsolete outlet.
- 10 Protect the power cord from being walked on or pinched particularly at plugs, convenience receptacles, and the point where they exit from the apparatus.
- 11 Only use attachments/accessories specified by the manufacturer.
- 12 Use only with the cart, stand, tripod, bracket, or table specified by the manufacturer, or sold with the apparatus. When a cart is used, use caution when moving the cart/apparatus combination to avoid injury from tip-over.
- 13 Unplug this apparatus during lightning storms or when unused for long periods of time.
- 14 Refer all servicing to qualified service personnel. Servicing is required when the apparatus has been damaged in any way, such as power-supply cord or plug is damaged, liquid has been spilled or objects have fallen into the apparatus, the apparatus has been exposed to rain or moisture, does not operate normally, or has been dropped.



### WARNING

TO REDUCE THE RISK OF FIRE OR ELECTRIC SHOCK, DO NOT EXPOSE THIS APPARATUS TO RAIN OR MOISTURE.

(UL60065\_03)

# PRECAUTIONS

## PLEASE READ CAREFULLY BEFORE PROCEEDING

Please keep this manual in a safe and handy place for future reference.

### For AC adaptor



#### WARNING

- This AC adaptor is designed for use with only Yamaha electronic instruments. Do not use for any other purpose.
- Indoor use only. Do not use in any wet environments.



#### CAUTION

- When setting up, make sure that the AC outlet is easily accessible. If some trouble or malfunction occurs, immediately turn off the power switch of the instrument and disconnect the AC adaptor from the outlet. When the AC adaptor is connected to the AC outlet, keep in mind that electricity is flowing at the minimum level, even if the power switch is turned off. When you are not using the instrument for a long time, make sure to unplug the power cord from the wall AC outlet.

### For DGX-660



#### WARNING

Always follow the basic precautions listed below to avoid the possibility of serious injury or even death from electrical shock, short-circuiting, damages, fire or other hazards. These precautions include, but are not limited to, the following:

#### Power supply/AC adaptor

- Do not place the power cord near heat sources such as heaters or radiators. Also, do not excessively bend or otherwise damage the cord, or place heavy objects on it.
- Only use the voltage specified as correct for the instrument. The required voltage is printed on the name plate of the instrument.
- Use the specified adaptor (page 91) only. Using the wrong adaptor can result in damage to the instrument or overheating.
- Check the electric plug periodically and remove any dirt or dust which may have accumulated on it.

#### Do not open

- This instrument contains no user-serviceable parts. Do not open the instrument or attempt to disassemble or modify the internal components in any way. If it should appear to be malfunctioning, discontinue use immediately and have it inspected by qualified Yamaha service personnel.

#### Water warning

- Do not expose the instrument to rain, use it near water or in damp or wet conditions, or place on it any containers (such as vases, bottles or glasses) containing liquids which might spill into any openings. If any liquid such as water seeps into the instrument, turn off the power immediately and unplug the power cord from the AC outlet. Then have the instrument inspected by qualified Yamaha service personnel.
- Never insert or remove an electric plug with wet hands.

#### Fire warning

- Do not put burning items, such as candles, on the unit. A burning item may fall over and cause a fire.

#### If you notice any abnormality

- When one of the following problems occur, immediately turn off the power switch and disconnect the electric plug from the outlet. Then have the device inspected by Yamaha service personnel.
  - The power cord or plug becomes frayed or damaged.
  - It emits unusual smells or smoke.
  - Some object has been dropped into the instrument.
  - There is a sudden loss of sound during use of the instrument.

## **CAUTION**

**Always follow the basic precautions listed below to avoid the possibility of physical injury to you or others, or damage to the instrument or other property. These precautions include, but are not limited to, the following:**

### **Power supply/AC adaptor**

- Do not connect the instrument to an electrical outlet using a multiple-connector. Doing so can result in lower sound quality, or possibly cause overheating in the outlet.
- When removing the electric plug from the instrument or an outlet, always hold the plug itself and not the cord. Pulling by the cord can damage it.
- Remove the electric plug from the outlet when the instrument is not to be used for extended periods of time, or during electrical storms.

### **Assembly**

- Read carefully the attached documentation explaining the assembly process. Failure to assemble the instrument in the proper sequence might result in damage to the instrument or even injury.

### **Location**

- Do not place the instrument in an unstable position where it might accidentally fall over.
- When transporting or moving the instrument, always use two or more people. Attempting to lift the instrument by yourself may damage your back, result in other injury, or cause damage to the instrument itself.
- Before moving the instrument, remove all connected cables, to prevent damage to the cables or injury to anyone who might trip over them.
- When setting up the product, make sure that the AC outlet you are using is easily accessible. If some trouble or malfunction occurs, immediately turn off the power switch and disconnect the plug from the outlet. Even when the power switch is turned off, electricity is still flowing to the product at the minimum level. When you are not using the product for a long time, make sure to unplug the power cord from the wall AC outlet.
- Use only the stand specified for the instrument. When attaching it, use the provided screws only. Failure to do so could cause damage to the internal components or result in the instrument falling over.

### **Connections**

- Before connecting the instrument to other electronic components, turn off the power for all components. Before turning the power on or off for all components, set all volume levels to minimum.
- Be sure to set the volumes of all components at their minimum levels and gradually raise the volume controls while playing the instrument to set the desired listening level.

### **Handling caution**

- Do not insert a finger or hand in any gaps on the instrument.
- Never insert or drop paper, metallic, or other objects into the gaps on the panel or keyboard. This could cause physical injury to you or others, damage to the instrument or other property, or operational failure.
- Do not rest your weight on, or place heavy objects on the instrument, and do not use excessive force on the buttons, switches or connectors.
- Do not use the instrument/device or headphones for a long period of time at a high or uncomfortable volume level, since this can cause permanent hearing loss. If you experience any hearing loss or ringing in the ears, consult a physician.

Yamaha cannot be held responsible for damage caused by improper use or modifications to the instrument, or data that is lost or destroyed.

Always turn the power off when the instrument is not in use.

Even when the [  ] (Standby/On) switch is in standby status (display is off), electricity is still flowing to the instrument at the minimum level.

When you are not using the instrument for a long time, make sure you unplug the power cord from the wall AC outlet.

## NOTICE

To avoid the possibility of malfunction/ damage to the product, damage to data, or damage to other property, follow the notices below.

### ■ Handling

- Do not use the instrument in the vicinity of a TV, radio, stereo equipment, mobile phone, or other electric devices. Otherwise, the instrument, TV, or radio may generate noise. When you use the instrument along with an application on your iPad, iPhone or iPod touch, we recommend that you set "Airplane Mode" to "ON" on that device in order to avoid noise caused by communication.
- Do not expose the instrument to excessive dust or vibrations, or extreme cold or heat (such as in direct sunlight, near a heater, or in a car during the day) to prevent the possibility of panel disfiguration, damage to the internal components or unstable operation. (Verified operating temperature range: 5° – 40°C, or 41° – 104°F.)
- Do not place vinyl, plastic or rubber objects on the instrument, since this might discolor the panel or keyboard.

### ■ Maintenance

- When cleaning the instrument, use a soft and dry/slightly damp cloth. Do not use paint thinners, solvents, alcohol, cleaning fluids, or chemical-impregnated wiping cloths.
- During extreme changes in temperature or humidity, condensation may occur and water may collect on the surface of the instrument. If water is left, the wooden parts may absorb the water and be damaged. Make sure to wipe any water off immediately with a soft cloth.

### ■ Saving data

- Some of the data of this instrument (page 52) are retained when the power is turned off. However, the saved data may be lost due to some failure, an operation mistake, etc. Save your important data onto USB flash drive/an external device such as a computer (page 76). For information about the handling of USB flash drive, refer to page 80.
- The recorded Songs are lost when you turn off the power to the instrument. This also occurs when the power is turned off by the Auto Power Off function (page 19). Save the data to the instrument, or to USB flash drive/an external device such as a computer (page 76). However, the data saved to the instrument may be lost due to some failure, an operation mistake, etc. Save your important data onto USB flash drive/an external device such as a computer (page 76). For information about the handling of USB flash drive, refer to page 80.
- To protect against data loss through USB flash drive damage, we recommend that you save your important data onto spare USB flash drive or an external device such as a computer as backup data.

## Information

### ■ About copyrights

- Copying of the commercially available musical data including but not limited to MIDI data and/or audio data is strictly prohibited except for your personal use.
- This product incorporates and bundles contents in which Yamaha owns copyrights or with respect to which Yamaha has license to use others' copyrights. Due to copyright laws and other relevant laws, you are NOT allowed to distribute media in which these contents are saved or recorded and remain virtually the same or very similar to those in the product.
  - \* The contents described above include a computer program, Accompaniment Style data, MIDI data, WAVE data, voice recording data, a score, score data, etc.
  - \* You are allowed to distribute medium in which your performance or music production using these contents is recorded, and the permission of Yamaha Corporation is not required in such cases.

### ■ About functions/data bundled with the instrument

- Some of the preset songs have been edited for length or arrangement, and may not be exactly the same as the original.

### ■ About this manual

- The illustrations and LCD screens as shown in this manual are for instructional purposes only, and may appear somewhat different from those on your instrument.
- Apple, iPhone, iPad and iPod touch are trademarks of Apple Inc., registered in the U.S. and other countries.
- The company names and product names in this manual are the trademarks or registered trademarks of their respective companies.

The model number, serial number, power requirements, etc., may be found on or near the name plate, which is at the bottom of the unit. You should note this serial number in the space provided below and retain this manual as a permanent record of your purchase to aid identification in the event of theft.

**Model No.**

---

**Serial No.**

---

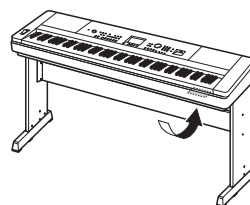

The name plate is located on the bottom of the unit.

(bottom\_en\_01)

# About Manuals

This instrument has the following documents and instructional materials.

## ■ Included Documents



### Owner's Manual (this book)

- Setting Up Please read this section first.
- Basic Guide This section explains how to use the basic functions. Refer to this section while playing the instrument.
- Reference This section explains how to make detailed settings for the various functions of the instrument.
- Appendix This section includes troubleshooting information and specifications.



### Data List

Contains various important preset content lists such as those of Voices, Styles, and Effects.

## ■ Online Materials (from Yamaha Downloads)



### MIDI Reference

Contains MIDI related information such as MIDI Data Format and the MIDI Implementation Chart.



### MIDI Basics (only in English, French, German and Spanish)

Contains basic explanations about MIDI.



### iPhone/iPad Connection Manual (only in English, French, German and Spanish)

Explains how to connect the instrument to smart devices, such as an iPhone, iPad, etc.



### Computer-related Operations

Includes instructions on connecting this instrument to a computer, and operations related to transferring files and MIDI data.

To obtain these manuals, access the Yamaha Downloads, enter the model name for searching the desired files.

**Yamaha Downloads** <http://download.yamaha.com/>

## ■ Online Material (for Yamaha Online members)



### Song Book (only in English, French, German and Spanish)

Contains music scores for the preset Songs (excluding the Over View Demo Song and Songs 1–11) of this instrument. After completing the user registration at the website below, you can download this Song Book free of charge.

**Yamaha Online Member** <https://member.yamaha.com/myproduct/regist/>

You will need the PRODUCT ID on the sheet “Online Member Product Registration” packaged with this manual in order to fill out the User Registration form.

## Included Accessories

- Owner's Manual (this book)
- Data List
- Keyboard Stand (page 12)
- Footswitch (page 21)
- Music Rest
- AC Adaptor \*1
- Warranty \*1
- Online Member Product Registration \*2

\*1: May not be included depending on your particular locale. Check with your Yamaha dealer.

\*2: The PRODUCT ID on the sheet will be needed when you fill out the User Registration form.

### Music Rest

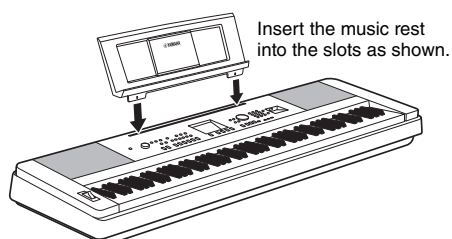



# Table of Contents

About Manuals .....	8
Included Accessories .....	8
Compatible Format .....	10
<b>Special Features</b> .....	<b>11</b>
<b>Setting Up</b>	
<b>Keyboard Stand Assembly</b> .....	<b>12</b>
<b>Panel Controls and Terminals</b> .....	<b>16</b>
Front Panel .....	16
Rear Panel .....	17
<b>Setting Up</b> .....	<b>18</b>
Power Requirements .....	18
Turning the Power On/Off .....	18
Setting the Volume .....	19
Auto Power Off Function .....	19
Connecting Headphones or External Audio Equipment (PHONES/OUTPUT Jack) .....	20
Connecting a Footswitch (SUSTAIN Jack) .....	21
Connecting a Pedal Unit (PEDAL UNIT jack) .....	22
<b>MAIN Display</b> .....	<b>23</b>
<b>Basic Controls</b> .....	<b>24</b>
<b>Basic Guide</b>	
<b>Enjoying Piano Performance (Piano Room)</b> .....	<b>25</b>
Playing a Piano Performance in the Piano Room .....	25
Recording your Performance as Audio in the Piano Room .....	26
<b>Try Playing a Variety of Instrument Voices</b> .....	<b>27</b>
Selecting a Main Voice .....	27
Playing the "Grand Piano" (Piano Reset) .....	27
Layering Two Voices—Dual Voice .....	28
Playing a Split Voice in the Left Hand area .....	28
Using the Metronome .....	29
Adding Harmony .....	31
<b>Playing Styles</b> .....	<b>32</b>
Using the Music Database .....	33
Chords .....	34
Using the Smart Chord feature .....	35
Calling up Optimum Styles for Your Performance (Style Recommender) .....	37
<b>Playing Songs and Audio Files</b> .....	<b>38</b>
Listening to the Overview Demo .....	38
Playing Back a Song or Audio File .....	39
Fast Forward, Rewind, and Pause .....	40
A-B Repeat .....	40
Turning Each Track On/Off .....	40
Displaying the Song Score .....	41
Displaying the Lyrics .....	41
<b>Using the Song Lesson Feature</b> .....	<b>42</b>
Three Types of Song Lesson .....	42
Practicing with Song Lesson .....	42
Making Practice Perfect—Repeat & Learn .....	43
<b>Recording Your Performance</b> .....	<b>44</b>
Song Recording .....	44
Recording to a Specified Track .....	46
Clearing a User Song .....	48
Clearing a Specified Track from a User Song .....	48
Audio Recording .....	49
<b>Memorizing Your Favorite Panel Settings</b> .....	<b>50</b>
Memorizing Panel Settings to the Registration Memory .....	50
Recalling Panel Settings from the Registration Memory .....	51
<b>Backup Parameters and Initialization</b> .....	<b>52</b>
Backup Parameters .....	52
Initialization .....	52

## Reference

<b>Handy Performance Features</b> .....	<b>53</b>
Selecting a Reverb Type .....	53
Selecting a Chorus Type .....	53
Selecting a DSP Type .....	54
Panel Sustain .....	55
Pitch Controls—Transpose .....	55
Pitch Controls—Tuning .....	56
Pitch Controls—the PITCH BEND wheel .....	56
Touch Response Sensitivity .....	57
Selecting an EQ Setting for the Best Sound .....	57
Setting the Output Gain Level .....	58
Speaker On/Off Setting .....	58
Intelligent Acoustic Control (IAC) .....	59
<b>Voice Settings</b> .....	<b>60</b>
Selecting a Dual Voice .....	60
Selecting a Split Voice .....	60
Voice Editing .....	60
<b>Style (Auto Accompaniment) Functions</b> .....	<b>61</b>
Style Variations—Sections .....	61
Changing the Tempo .....	63
Adjusting the Volume of the Style .....	63
Playing Chords Without Style Playback (Stop Accompaniment) .....	63
Setting the Split Point .....	64
Setting the Chord Fingering .....	64
Looking Up Chords Using the Chord Dictionary .....	65
<b>Song and Audio Settings</b> .....	<b>66</b>
Background Music (BGM) Playback .....	66
Random Playback .....	66
Tempo Setting of the Song .....	67
Song Volume .....	67
Audio Volume .....	67
Changing the Voice of the Song .....	68
Specifying the Channel for the Lesson Part .....	68
<b>Connecting a Microphone and Singing Along with Your Performance</b> .....	<b>69</b>
Connecting a Microphone .....	69
Selecting a Preset Setting .....	70
Making and Saving the Microphone Settings .....	70
Calling Up the Microphone Settings Saved to USER .....	71
<b>The Functions</b> .....	<b>72</b>
Function List .....	73
<b>Connections</b> .....	<b>76</b>
<b>– Using Your Instrument with Other Devices –</b> .....	<b>76</b>
Connecting an Audio Device (AUX IN jack) .....	76
Connecting to a Computer (USB TO HOST terminal) .....	76
Connecting to an iPhone/iPad (USB TO DEVICE, USB TO HOST terminals) .....	77
Wireless LAN Settings .....	77
<b>USB Flash Drive Operations</b> .....	<b>80</b>
Connecting a USB Flash Drive .....	81
Formatting a USB Flash Drive .....	82
Saving a Registration Memory to USB Flash Drive .....	83
Saving a User Song to USB Flash Drive .....	84
Converting a User Song to an Audio file .....	85
Loading Files from a USB Flash Drive .....	86
Deleting files from a USB Flash Drive .....	87
Deleting User Data from the Instrument .....	87
<b>Appendix</b>	
<b>Troubleshooting</b> .....	<b>88</b>
<b>Messages</b> .....	<b>89</b>
<b>Specifications</b> .....	<b>90</b>
<b>Index</b> .....	<b>92</b>

## Compatible Format

---



### **GM System Level 1**

“GM System Level 1” is an addition to the MIDI standard which ensures that any GM-compatible music data can be accurately played by any GM-compatible tone generator, regardless of manufacturer. The GM mark is affixed to all software and hardware products that support GM System Level.



### **XF**

The Yamaha XF format enhances the SMF (Standard MIDI File) standard with greater functionality and open-ended expandability for the future. The instrument is capable of displaying lyrics when an XF file containing lyric data is played.



### **Style File Format Guitar Edition**

“SFF (Style File Format)” is an original Style file format by Yamaha which uses a unique conversion system to provide high-quality automatic accompaniment based on a wide range of chord types. “SFF GE (Guitar Edition)” is an enhanced format of SFF, which features improved note transposition for guitar tracks.



### **XGlite**

As its name implies, “XGlite” is a simplified version of Yamaha’s high-quality XG tone generation format. Naturally, you can play back any XG song data using an XGlite tone generator. However, keep in mind that some songs may play back differently compared to the original data, due to the reduced set of control parameters and effects.

# Special Features

## Amazingly Authentic Piano Sound and “Piano Room” Performance Controls

► Page 27, 25

The DGX-660 features an authentically expressive piano Voice (“Natural! Grand Piano”; Voice 001) meticulously sampled from a concert grand piano—perfect for playing not only classical compositions but also piano pieces in any style. No matter what instrument settings have been made, you can instantly call up the Piano Voice by simply pressing and holding the [PIANO ROOM] button.

In addition, the instrument has a special Piano Room feature that provides even greater piano performance enjoyment with highly intuitive control. Piano Room lets you select the desired piano type as well as different room ambiences, giving you a complete, realistic piano experience—as if you were playing a real piano.

## Graded Hammer Standard Keyboard

Thanks to our experience as the world’s leading manufacturer of acoustic pianos, we’ve developed a keyboard with action that’s virtually indistinguishable from the real thing. Just as on a traditional acoustic piano, the keys of the lower notes have a heavier touch, while the higher ones are more responsive to lighter playing. The keyboard’s sensitivity can even be adjusted to match your playing style. This Graded Hammer technology gives the DGX-660 remarkably authentic touch in a lightweight instrument.

## Amazingly Realistic and Dynamic Sounds ► Page 27

Yamaha’s authentic Voices (especially the highly acclaimed Live!, Sweet! and Cool! Voices) deliver incredibly natural and dynamic sound—with all the nuances of the original instrument, from delicate to powerful.

## Play Along with Styles ► Page 32

The DGX-660 also has complete and fully automatic accompaniment features with the Styles. These Styles provide the equivalent of a full backing band covering wide variety of genres—from waltz and swing to 8-beat and euro-trance, plus much more. Select a Style that matches the music you want to play, or experiment with new Styles to expand your musical horizons. And if it’s difficult to select the right Style from the huge variety available, use the Style Recommender function, which calls up a list of suggested Styles, based on a sample rhythm you play. Also, this instrument features a Smart Chord function, allowing you to simply press single keys, and yet play various chord progressions that authentically match the music genre and key you specify—giving you even greater enjoyment from the Styles!

## Easy Performance with Music Notation Display ► Page 41

When you play back a Song, the corresponding score is shown on the display. This is a great way to learn how to read music. If the Song contains lyric and chord data, the lyrics and chords also appear in the score.

## Connect a Microphone and Sing Along with Your Own Performance ► Page 69

Simply connect a microphone to the DGX-660, sing along with your keyboard performance or with Song playback—and hear everything mixed perfectly together from the instrument’s speakers. Three convenient preset settings are provided for different vocal performance preferences and situations, and you can even make and save your own original microphone settings.

# Keyboard Stand Assembly

## CAUTION

Read these cautions carefully before you assemble or use the keyboard stand. These cautions are to promote safe use of the stand and to prevent injury and damage from occurring to you and others. By following these cautions carefully, your keyboard stand will provide you with safe and prolonged use.

- Be careful not to confuse parts, and be sure to install all parts in the correct direction. Please assemble in accordance with the sequence given below.
- Assembly should be carried out by at least two persons.
- Be sure to use the correct screw size, as indicated below. Use of incorrect screws can cause damage.
- Use the stand after assembly is complete. An uncompleted stand may overturn or the keyboard may drop.
- Always place the stand on a flat, stable surface. Placing the stand on uneven surfaces may cause it to become unstable or overturn, the keyboard to drop, or injury.
- Do not use the stand for anything other than its designed purpose. Placing other objects on the stand may result in the object dropping or the stand overturning.
- Do not apply excessive force to the keyboard as it may cause the stand to overturn or the keyboard to drop.
- Make sure the stand is sturdy and safe, and all screws have been tight and firm before use. If not, the stand may overturn, the keyboard may drop, or may result in injury to the user.
- To disassemble, reverse the assembly sequence given below.

Have a phillips-head (+) screwdriver of the appropriate size ready.

1 The parts shown in the “Assembly Parts” illustration will be used. Follow the assembly instructions and select the parts as needed.

1

## Assembly Parts

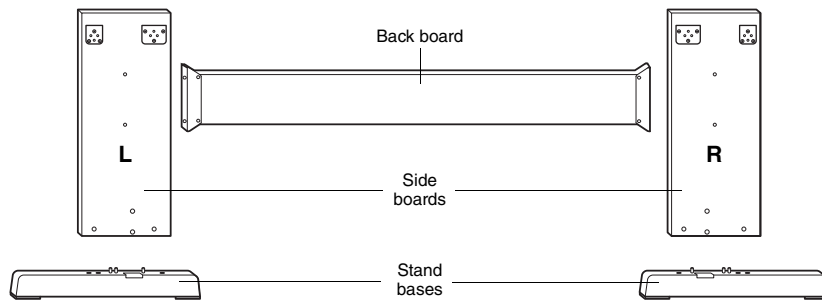

A (1 pc.)    B (1 pc.)    C (2 pcs.)



1 Joint connectors  
(4 pcs.)



2 Metal brackets



3 3 x 8 mm roundhead  
screws (12 pcs.)



4 6 x 70 mm roundhead  
screws (4 pcs.)



5 6 x 30 mm roundhead  
screws (4 pcs.)



6 5 x 16 mm roundhead  
screws (4 pcs.)

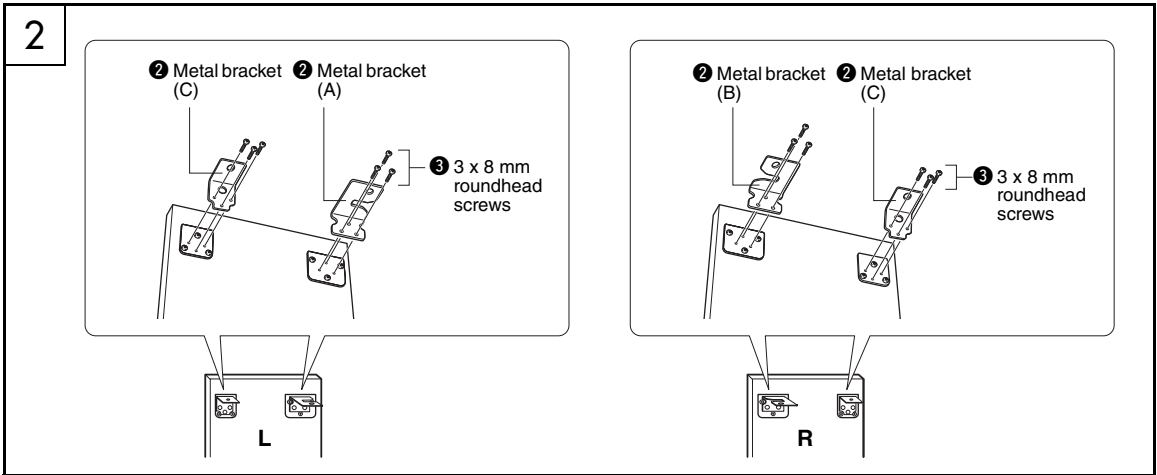

**2 Attach the metal brackets.**

Attach the metal brackets ② to the top of the side boards, using the screws ③ as shown.

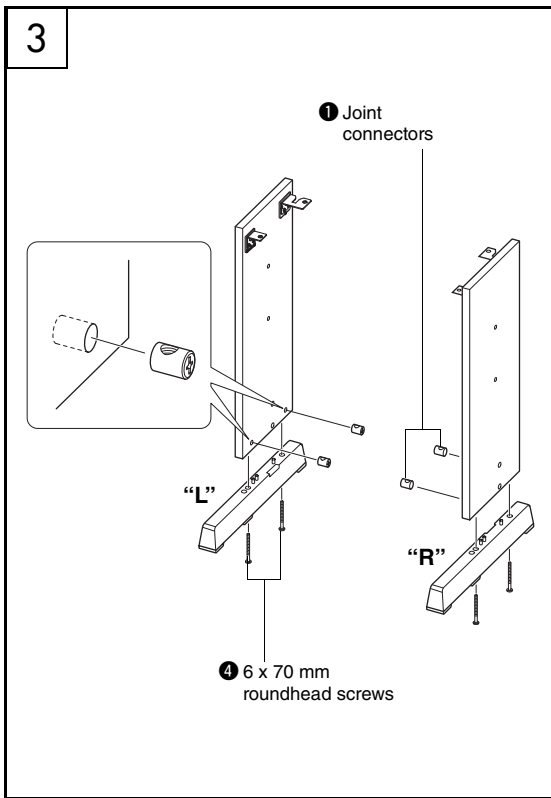

**3 Attach the stand bases.**

Insert the joint connectors ① into the side boards as shown. The joint connectors have been installed properly if you can see the screw head on the connector.

**NOTE**

- If you put the connectors in wrong direction and want to take them out, tap around the holes on the boards.

Attach the “L” (Left) and “R” (Right) stand bases to the bottom of the side boards, using the screws ④. “L” (Left) and “R” (Right) are marked on the upper surfaces of the stand bases. If you have trouble fastening the screws, use a screwdriver to rotate the joint connectors so that the connector holes are aligned with the screw holes on the stand bases.

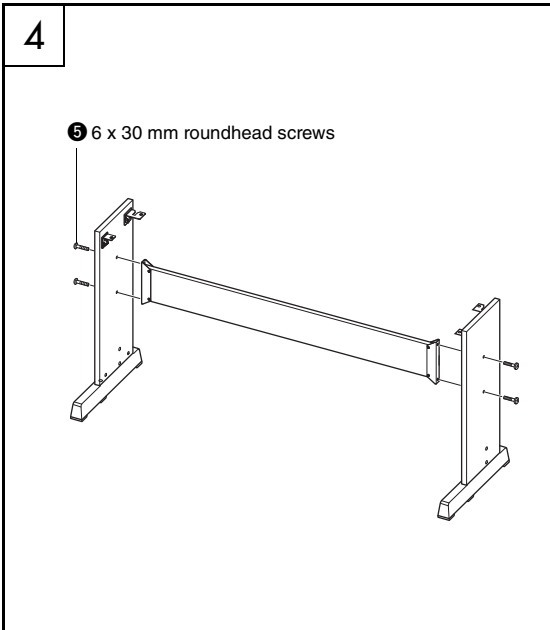

## 4 Attach the back board.

Attach the back board, using the screws ⑤. Check the back-to-front orientation for the side boards. Make sure the non-colored surface is facing down.

### ⚠ CAUTION

- Be careful not to drop the back board or touch the sharp metal fittings.

### NOTE

- If you have purchased a pedal unit (sold separately), attach the pedal unit before proceeding to the next step. Refer to the instructions provided with your pedal unit.
- For information on the pedal functions, refer to page 22.

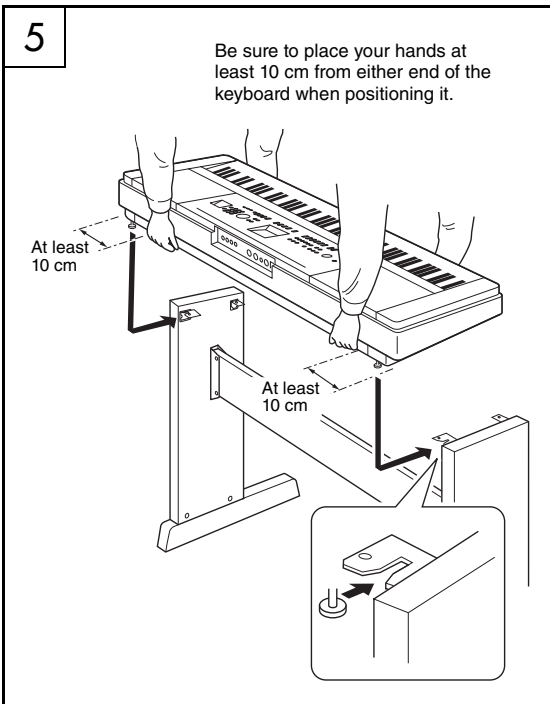

## 5 Put the keyboard on the stand.

Check the back-to-front orientation for stand, and carefully place the keyboard on the side boards. Slowly move the keyboard so that the holes on the bottom of the keyboard are properly aligned with the holes on the angle brackets.

### ⚠ CAUTION

- Be careful not to drop the keyboard or to get your fingers caught between the keyboard and the stand parts.
- Do not hold the keyboard in any position other than the position shown in the illustration.

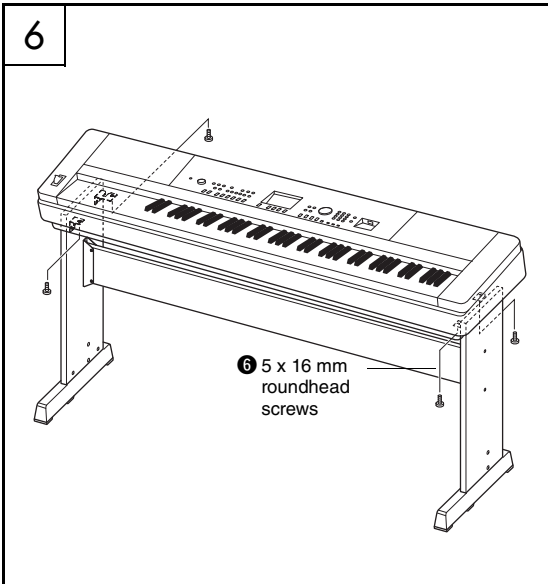

## 6 Install the keyboard to the stand.

Fix the keyboard to the angle brackets, using the screws 6.

### Post-assembly checklist

Once you've assembled the stand, check the following points:

- Are there any parts left over?  
→ If so, read the assembly instructions again and correct any errors you might have made.
- Is the instrument clear of doors and other movable fixtures?  
→ If not, move the instrument to an appropriate location.
- Does the instrument make a rattling noise when you play it or move it?  
→ If so, properly tighten all screws.
- Also, if the keyboard makes a creaking noise or seems unsteady when you play it, refer carefully to the assembly instructions and diagrams and retighten all screws.

# Panel Controls and Terminals

## Front Panel

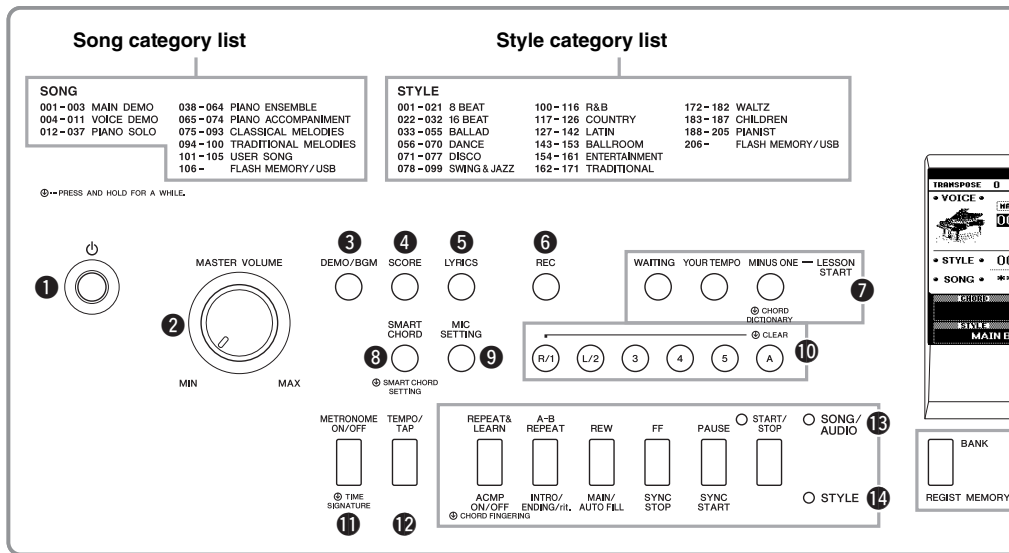

## Front Panel

- ① [⏻] (Standby/On) switch..... page 18
- ② [MASTER VOLUME] control ..... page 19
- ③ [DEMO/BGM] button ..... pages 38, 66
- ④ [SCORE] button.....page 41
- ⑤ [LYRICS] button.....page 41
- ⑥ [REC] button..... pages 44, 46, 49
- ⑦ LESSON START
  - [WAITING] button.....page 43
  - [YOUR TEMPO] button .....page 43
  - [MINUS ONE] button.....page 43
- ⑧ [SMART CHORD] button.....page 35
- ⑨ [MIC SETTING] button .....page 69
- ⑩ Song Track
  - [1]–[5], [A] buttons.....page 40
- Lesson
  - [R] and [L] buttons .....page 42
- ⑪ [METRONOME ON/OFF] button ..... page 29
- ⑫ [TEMPO/TAP] button..... pages 63, 67
- ⑬ SONG/AUDIO
  - [REPEAT&LEARN] button..... page 43
  - [A-B REPEAT] button..... page 40
  - [REW] button.....page 40
  - [FF] button.....page 40
  - [PAUSE] button .....page 40
  - [START/STOP] button .....page 39
- ⑭ STYLE
  - [ACMP ON/OFF] button ..... page 32
  - [INTRO/ENDING/rit.] button .....page 61
  - [MAIN/AUTO FILL] button .....page 61
  - [SYNC STOP] button .....page 62
  - [SYNC START] button.....page 33
  - [START/STOP] button.....page 33
- ⑮ REGIST MEMORY
  - [BANK], [1]–[4] buttons..... page 50
- ⑯ CATEGORY [◀] and [▶] buttons ..... page 24
- ⑰ [EXIT] button ..... page 23
- ⑱ [EXECUTE] button ..... page 82
- ⑲ DATA ENTRY
  - Dial, Number buttons [0]–[9], [+] and [-] buttons ..... page 24
- ⑳ [FILE CONTROL] button..... page 82
- ㉑ [FUNCTION] button..... page 72
- ㉒ [PIANO ROOM] button .....page 25
- ㉓ [SONG/AUDIO] button .....page 39
- ㉔ [STYLE] button .....page 32
- ㉕ [VOICE] button .....page 27
- ㉖ [MUSIC DATABASE] button.....page 33
- ㉗ [SPLIT ON/OFF] button .....page 28
- ㉘ [DUAL ON/OFF] button .....page 28
- ㉙ [HARMONY ON/OFF] button .....page 31
- ㉚ [PITCH BEND] wheel .....page 56
- ㉛ USB TO DEVICE terminal ..... pages 77, 80, 81



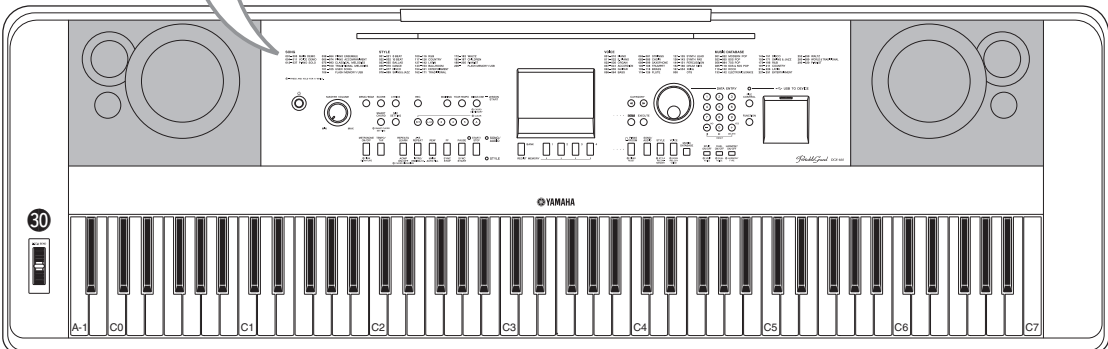
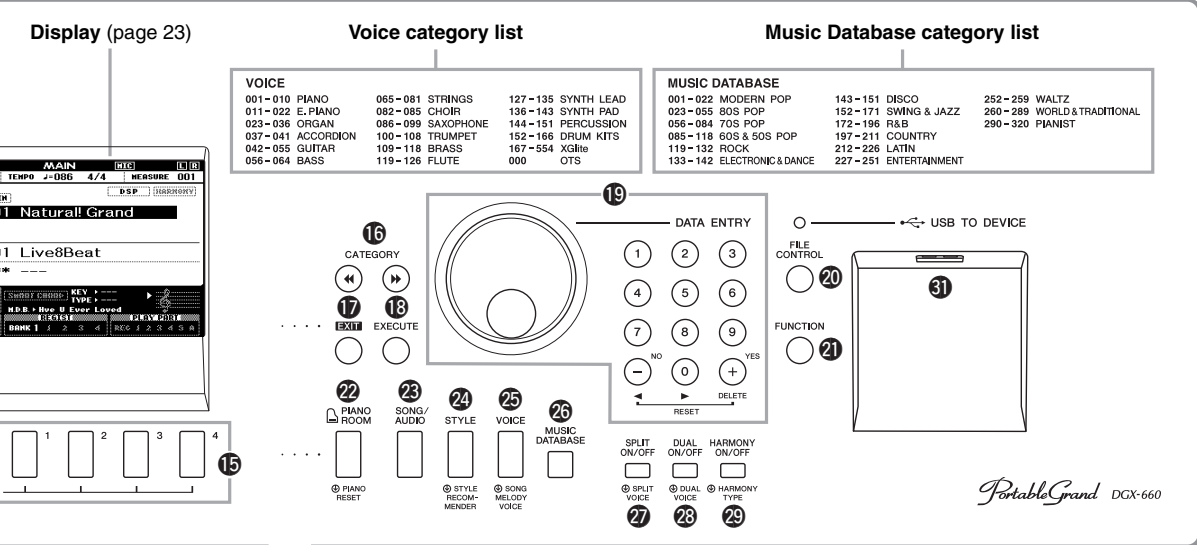

Rear Panel

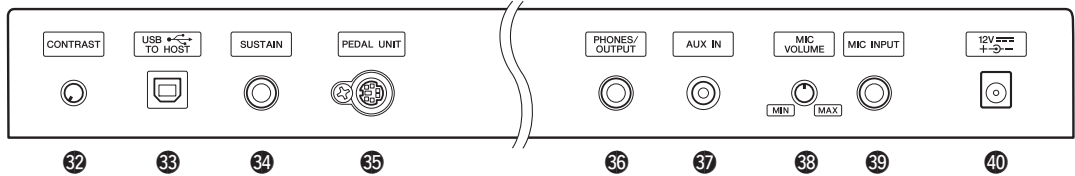

Rear Panel

- 32** CONTRAST knob .....page 23
- 33** USB TO HOST terminal..... pages 74, 76, 77
- 34** SUSTAIN jack .....page 21
- 35** PEDAL UNIT jack .....page 22
- 36** PHONES/OUTPUT jack .....page 20
- 37** AUX IN jack .....page 76
- 38** MIC VOLUME knob .....page 69
- 39** MIC INPUT jack .....page 69
- 40** DC IN jack .....page 18

**“Press & Hold” symbol**  
 By holding down one of the buttons having this symbol, you can call up an alternate function, other than the one called up when simply pressing.

# Setting Up

## Power Requirements

### ⚠ WARNING

- Use the specified adaptor (page 91) only. Using the wrong adaptor can result in damage to the instrument or overheating.

1 Connect the AC power adaptor to the DC IN jack.

2 Plug the AC power adaptor into an AC outlet.

### ⚠ CAUTION

- Unplug the AC Power Adaptor when not using the instrument, or during electrical storms, to avoid the possibility of physical injury to you or others, or damage to the instrument or other property.

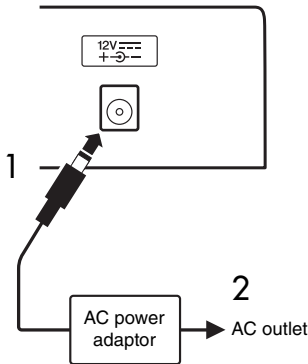

### For the Power Adaptor with a Removable Plug

Do not remove the plug from the power adaptor. If the plug is removed accidentally, slide the plug into place without touching the metallic parts, and then push the plug in completely until it clicks.

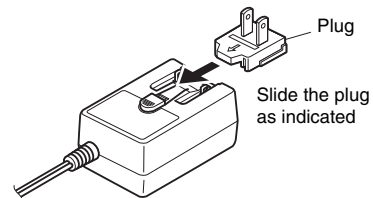

\* The shape of the plug differs depending on locale.

### ⚠ WARNING

- Make sure to keep the plug attached to the AC adaptor. Using the plug alone can cause electric shock or fire.
- Never touch the metallic section when attaching the plug. To avoid electric shock, short circuit or damage, also be careful that there is no dust between the AC adaptor and plug.

## Turning the Power On/Off

Turn down the MASTER VOLUME control to “MIN” then press the [⏻] (Standby/On) switch to turn on the power. While playing the keyboard, adjust the MASTER VOLUME control. To turn off the power, press the [⏻] (Standby/On) switch again for a second.

### ⚠ CAUTION

- When using a power adaptor, even when the power is off, a small amount of electricity is still being consumed by the instrument. When you are not using the instrument for a long time, make sure to unplug the AC power adaptor from the wall AC outlet.

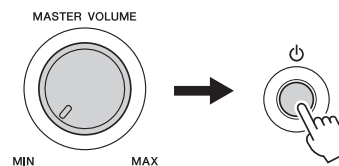

## Setting the Volume

To adjust the volume level of the entire keyboard sound, use the MASTER VOLUME control located at the left of the panel. Play the keyboard to actually produce sound while you adjusting the volume to the desired level.

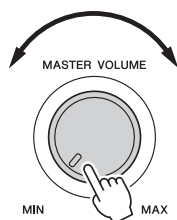

### CAUTION

- Do not use the instrument for a long period of time at a high or uncomfortable volume level, since this can cause permanent hearing loss. If you experience any hearing loss or ringing in the ears, consult a physician.

### Intelligent Acoustic Control (IAC)

IAC is a function which automatically adjusts and controls the sound quality according to the overall volume of the instrument. Even when the volume is low, it permits both low sounds and high sounds to be clearly heard. For details, refer to page 59.

## Auto Power Off Function

To prevent unnecessary power consumption, this instrument features an Auto Power Off function that automatically turns the power off if the instrument is not operated for a specified period of time. The amount of time that will elapse before the power is automatically turned off is set by default to 30 minutes.

### To disable the Auto Power Off function:

Turn off the power, then press the [⏻] (Standby/On) switch to turn on the power while holding down the lowest key. Make sure to hold down lowest key until a message appears at the top left of the display after pressing the power switch.

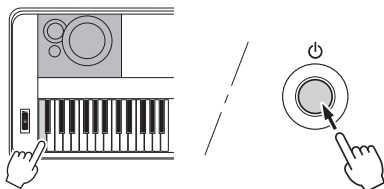

### To set the time that elapses before Auto Power Off is executed:

Press the [FUNCTION] button, press the CATEGORY [◀◀] or [▶▶] button several times until “Auto Power Off” appears, then select the desired value by using the dial.

**Settings:** OFF, 5, 10, 15, 30, 60, 120 (min.)

**Default value:** 30 min.

### NOTICE

- The recorded Song will be lost if the power is automatically turned off without executing the save operation. Make sure to save your recorded Song before the power turns off.
- Depending on the instrument status, the power may not turn off automatically, even after the elapse of the specified period of time. Always turn off the power manually when the instrument is not in use.
- When the instrument is not operated for a specified period of time while connected to an external device such as an amplifier, speaker or computer, make sure to follow the instructions in the Owner's Manual to turn off the power to the instrument and the connected devices, in order to protect the devices from damage. If you do not want the power to turn off automatically when a device is connected, disable Auto Power Off.

## Connecting Headphones or External Audio Equipment (PHONES/OUTPUT Jack)

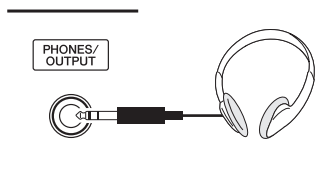

### Headphones

Any pair of stereo headphones with a standard stereo phone plug can be plugged in here for convenient monitoring. The speakers are automatically shut off when a plug is inserted into this jack. This setting can be changed so that speaker sound is always on regardless whether a plug is inserted or not (page 58).

### External Audio Equipment

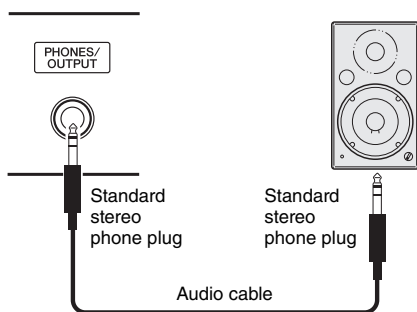

The PHONES/OUTPUT jack also functions as an external output. You can connect the PHONES/OUTPUT jack to a keyboard amplifier, stereo system, mixer, tape recorder, or other line-level audio device to send the instrument's output signal to that device.

### Optimum setting

Output gain level for this jack is set to a value suitable for connecting headphones, as the default setting. You can switch this to the value suitable for connecting an external audio device. For details on how to switch the value, see page 58.

### CAUTION

- Before connecting the instrument to other electronic components, turn off the power of all the components. Also, before turning any components on or off, make sure to set all volume levels to minimum (0). Otherwise, damage to the components, electrical shock, or even permanent hearing loss may occur.

### CAUTION

- Do not use the instrument/device or headphones for a long period of time at a high or uncomfortable volume level, since this can cause permanent hearing loss. If you experience any hearing loss or ringing in the ears, consult a physician.

### NOTICE

- When the instrument's sound is output to an external device, first turn on the power to the instrument, then to the external device. Reverse this order when you turn the power off. If the instrument's power is automatically turned off via the Auto Power Off function (page 19), first turn off the external device, then turn on the power to the instrument then the external device again.

### NOTICE

- Do not route the output from the PHONES/OUTPUT jack to the AUX IN jack. If you make this connection, the signal input at the AUX IN jack is output from the PHONES/OUTPUT jack. These connections could result in a feedback loop that will make normal performance impossible, and may even damage both pieces of equipment.

### NOTE

- Use audio cables and adaptor cables having no (zero) resistance.

## Connecting a Footswitch (SUSTAIN Jack)

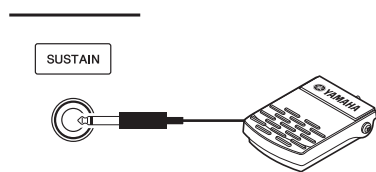

The sustain function lets you produce a natural sustain as you play by pressing a footswitch. Plug the supplied footswitch into this jack and use it to switch sustain on and off.

An FC3A foot pedal or FC4A or FC5 footswitch (sold separately) can also be connected to this jack. The FC3A lets you use the Half Pedal function (page 22).

### NOTE

- Make sure that power is off when connecting or disconnecting a footswitch or a foot pedal.
- Do not press the footswitch while turning the power on. Doing this changes the recognized polarity of the footswitch, resulting in reversed footswitch operation.
- The sustain function does not affect the Split Voice (page 28).

### Damper Resonance

This function simulates the sustain sound produced with the damper pedal on a grand piano. If you want to use this function, select a voice in the “Target Voice List” below, then press the footswitch. This function can be turned off via the FUNCTION display (page 74). For information on how to select a Voice, see page 27.

#### Target Voice List

Voice No.	Voice Name
001	Natural! Grand Piano
003	Live! Pop Grand Piano
004	Live! Warm Grand Piano
008	Honky Tonk Piano
167	Natural Grand Piano (XG)
169	Live Pop Grand Piano (XG)
170	Live Warm Grand Piano (XG)
173	Honky Tonk Piano (XG)

### NOTE

- This effect is applied only to a Voice in the “Target Voice List” selected as the Main Voice or used in Track 1 (page 68) of the Song.

### Assigning specific functions to the pedal

The function of the footswitch or the foot pedal connected to SUSTAIN jack can be changed from its default setting (Sustain).

Press the [FUNCTION] button, press the CATEGORY [◀◀] or [▶▶] button repeatedly until “Assignable Pedal” appears, then select the desired setting by using the dial.

SUSTAIN	Allows you to use a pedal to control sustain. When you press and hold the pedal, all notes played on the keyboard have a longer sustain.
PORTAMENTO	<p>The portamento effect (a smooth slide between notes) can be produced while the pedal is pressed. Portamento is produced when notes are played legato style (i.e., a note is played while the preceding note is still held). The portamento time can also be adjusted in the Function “Portamento Time” (page 74).</p> <p><b>NOTE</b></p> <ul style="list-style-type: none"> <li>• This function does not affect the Voice 001 “Natural! Grand Piano” and 167 “Natural Grand Piano (XG)”, which would not sound appropriately with this function.</li> <li>• This affects only Main/Dual Voices and the Harmony sound (pages 27, 28 and 31), and has no effect on the Split Voices (page 28).</li> </ul>
MIC ON/OFF	Turns the microphone sound on or off (page 71).
START/STOP	Same as the [START/STOP] button (pages 33, 39).
TAP TEMPO	When Style and Song are stopped, tapping the pedal at the desired tempo—four times for time signatures in 4 (4/4, etc.), and three times for time signatures in 3 (3/4, etc.) starts playback of the rhythm part of the Style or the Song at the tempo you tapped the pedal. During playback of a Style or Song, you can change the tempo by tapping the pedal twice at the desired tempo.

## Connecting a Pedal Unit (PEDAL UNIT jack)

This jack is for connecting an LP-7A/LP-7AWH pedal unit (sold separately). When connecting the pedal unit, make sure to also assemble the unit on the supplied keyboard stand.

**NOTE**

- Make sure that power is off when connecting or disconnecting the pedal unit.
- This affects only Main/Dual Voices and Harmony sound (pages 27, 28 and 31).
- The functions of the pedals of the pedal unit cannot be changed.

### Half Pedal function (for FC3A and LP-7A/LP-7AWH)

This function allows you to vary the sustain length depending on how far the pedal is pressed. The farther you press the pedal, the more the sound sustains. For example, if you press the damper pedal and the notes you play sound a bit murky and loud with too much sustain, you can partially release the pedal to lessen the sustain (murkiness).

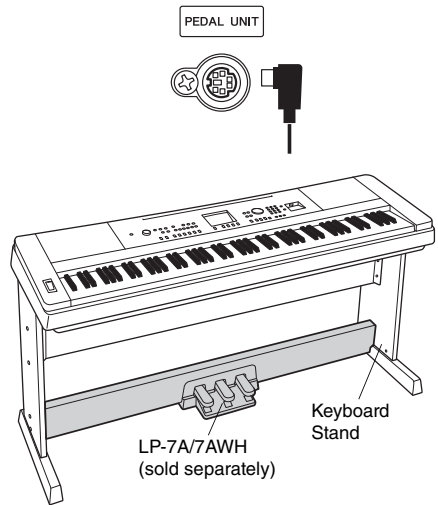

### Pedal Unit functions

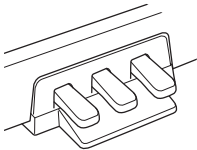

#### Damper Pedal (Right)

Pressing this pedal will sustain notes longer. Releasing this pedal immediately stops (damps) any sustained notes. This pedal lets you use the Damper Resonance (page 21) and Half Pedal (see above) functions. When using both a footswitch and pedal unit, the last effect applied takes priority.

#### Sostenuto Pedal (Center)

If you play a note or notes on the keyboard and press the sostenuto pedal while the note(s) are held, those notes will sustain as long as you hold the pedal (as if the damper pedal had been pressed) but all subsequently played notes will not be sustained. This makes it possible to sustain a note or notes, for example, while other notes are played “staccato.”

#### Soft Pedal (Left)

The soft pedal reduces the volume and slightly changes the timbre of notes played while the pedal is pressed. The soft pedal will not affect notes that are already playing when it is pressed.

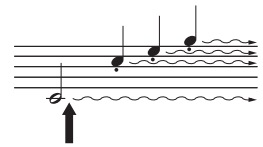

If you press and hold the damper pedal here, all the notes shown will be sustained.

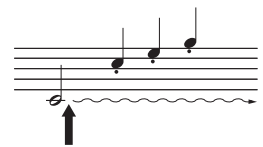

If you press and hold the sostenuto pedal here, only the notes held at this timing will be sustained.



# MAIN Display

When the power is turned on, the MAIN display automatically appears. This display shows the basic settings of the instrument, including the current Voice, Style, Song, Audio and other settings.

**To Return to the MAIN Display**  
 You can return to the MAIN display from any other display by pressing the [EXIT] button.



**CONTRAST knob**  
 Adjust the CONTRAST knob on the rear panel of the instrument for optimum display legibility.



**MIC**  
 Appears when MIC is set to ON (page 69).

**A-B Repeat**  
 Appears when A-B Repeat (page 40) playback is engaged.

**Lesson part**  
 Shows the current Lesson part (page 42).

Time Signature  
 Display Title  
 Tempo  
 Transpose

Measure Number

Appears when the corresponding function is turned on.  
 Page 54  
 Page 31

**Style**  
 Indicates the current Style (page 32).

**Voice**  
 Indicates the current Voices (Main, Dual and Split) (pages 27, 28).

**Song or Audio**  
 Indicates the current Song or Audio file.

- SONG • 001 JetSet
- AUDIO • 000 New Audio

Chord indication

**Smart Chord setting** (page 35)  
**M.D.B.**  
 Indicates the current M.D.B. (page 33).

**Style Status**



**ACMP** Appears when Auto Accompaniment (ACMP) is on.

 Appears when the Synchro Stop function is engaged.

**MAIN B**  
 Shows section name

**Registration Memory Status**



**BANK 1** Shows the selected bank number.

 Shows the memory numbers that contain data. A border appears around the selected number.

**Song Track Status**  
 Indicates the track status of the current Song (pages 40 and 46).



Highlighted when ready for recording.

Specified as Song recording target.

Contains data and is muted.

Contains no data.

Contains data and can be played back.

# Basic Controls

Before operating the instrument, it may be helpful to familiarize yourself with the basic controls below that are used to select items and change values.

## ■ Dial

Rotate the dial clockwise to increase the value, or counterclockwise to decrease the value.

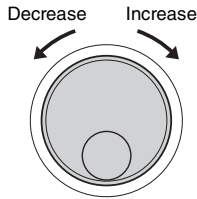

## ■ Number buttons

Use the Number buttons to directly enter a number or parameter value.

For numbers that start with one or two zeroes (such as “003”), the first zeroes can be omitted. However, completely entering [0]→[0]→[3] will display “003” quicker than pressing only [3].

**Example: Selecting Voice 003**

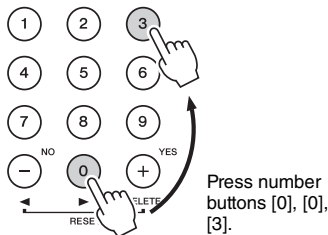

## ■ [-] and [+] buttons

Press the [+] button briefly to increase the value by 1, or press the [-] button briefly to decrease the value by 1. Press and hold either button to continuously increase or decrease the value in the corresponding direction. To restore the value to the default setting, press both buttons simultaneously.

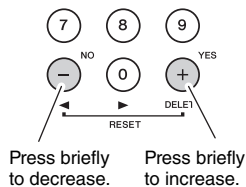

## ■ CATEGORY buttons

Use these buttons to jump to the first Voice, Style, or Song in the next or previous Category, and call up the next or previous Function sequentially.



**Example: VOICE SELECT (MAIN) display**

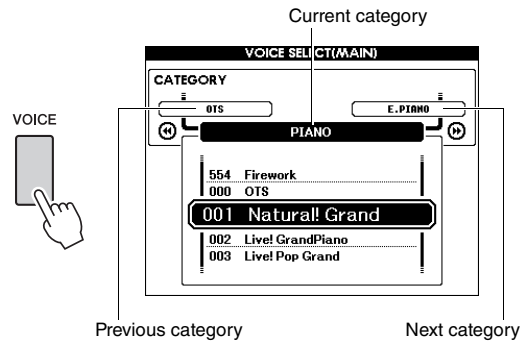

In most procedures described throughout this owner's manual the dial is recommended for selection simply because it is the easiest and most intuitive selection method. Please note however, that most items or values that can be selected using the dial can also be selected using the [+] and [-] buttons.



# Enjoying Piano Performance (Piano Room)

The Piano Room function is for those who want to simply, conveniently, and fully enjoy playing the instrument as a piano. No matter what settings you've made from the panel, you can instantly call up the optimum settings for piano performance with a single button press. You can also change the piano settings as you desire, or record your performance in the Piano Room as an audio file.

## Playing a Piano Performance in the Piano Room

- 1 Press the [PIANO ROOM] button to call up the Piano Room display.



This operation calls up the panel settings for piano performance. All other functions except for the relevant buttons ([BANK], REGIST MEMORY [1]–[4], CATEGORY [◀]/[▶]), [EXIT], [EXECUTE], [+], [–] (YES), [–] (NO), [METRONOME ON/OFF], [TEMPO/TAP] buttons), the dial, the pedal, the PITCH BEND wheel and master volume setting are disabled.

- 2 Use the [BANK] and REGIST MEMORY [1]–[4] buttons to set the desired piano settings.

To call up the DETAIL display, press the REGIST MEMORY [4] button.

You can change the display by pressing the REGIST MEMORY [4] button repeatedly. (MAIN → DETAIL → RECORD → MAIN)

### NOTE

- You can change the settings also by using the dial, CATEGORY [◀]/[▶], [+], [–] (YES)/[–] (NO) buttons.

### MAIN display

Button	Function	Description
[1]	ENVIRONMENT*	For selecting the environment (Reverb Type). <ul style="list-style-type: none"> <li>CONCERT (Concert Hall)</li> <li>RECITAL (Recital Hall)</li> <li>STAGE</li> <li>ROOM</li> <li>OFF</li> </ul>
[2]	PIANO*	For selecting the desired Piano type. <ul style="list-style-type: none"> <li>GRAND (Grand Piano)</li> <li>POP (Pop Grand)</li> <li>WARM (Warm Grand)</li> <li>H. TONK (Honky Tonk)</li> </ul>
[3]	LID POS.* (Lid Position)	Determines how much the Lid is opened. This cannot be set when "Honky Tonk" is selected.
[4]	DETAIL	For calling up the detailed setting display.

### Detail setting display

Button	Function	Description
[BANK]	TOUCH*	For selecting the Touch Response sensitivity (page 57). <ul style="list-style-type: none"> <li>SOFT</li> <li>MEDIUM</li> <li>HARD</li> </ul>
[1]	TUNE*	Determines the pitch of this instrument in 1Hz steps. Setting range: 416Hz–466Hz
[2]	D. RESO.* (Damper Resonance)	Determines whether Damper Resonance is applied (ON) or not (OFF).
[3]	RESET	Restores all settings of Piano Room to the default. After a message appears, press the [+], [–] (YES) button to restore all settings.
[4]	RECORD	For calling up the recording display (page 26).

- \* The settings marked with \* (asterisk) will be maintained even if you exit from this display or turn off the power. Pressing the [PIANO ROOM] button next time will call up the previously entered Piano settings.

- 3 Play the keyboard.

### NOTE

- You can turn the Metronome on or off by pressing the [METRONOME ON/OFF] button. For information on setting the Metronome tempo and time signature, refer to page 29.

- 4 Press the [EXIT] button to exit the Piano Room display.

## Recording your Performance as Audio in the Piano Room

You can record your performance in the Piano Room to a USB flash drive as an audio file.

### 1 Connect the USB flash drive to the USB TO DEVICE terminal.

Before using a USB flash drive, be sure to read “Precautions when using the USB TO DEVICE terminal” on page 80.

#### NOTICE

- Never attempt to disconnect the USB flash drive or turn the power off during recording. Doing so may corrupt the USB flash drive data or the recording data.

### 2 Press the [PIANO ROOM] button to call up the Piano Room display.

Make settings as desired, such as Piano type, environment, lid position and so on.

### 3 Press the REGIST MEMORY [4] button once or twice to call up the “RECORD” display.

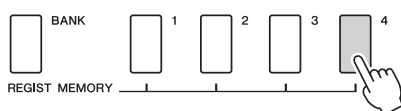

#### NOTE

- You can change the display by pressing the REGIST MEMORY [4] button repeatedly. (MAIN → DETAIL → RECORD → MAIN)

### 4 Press the REGIST MEMORY [1] button to start recording, then play the keyboard.

“RECORD” display

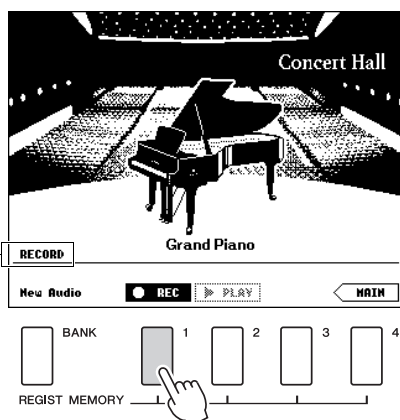

#### NOTE

- A moving series of dots (...) appear in the display when recording setup takes a long time. If this happens, wait to play the keyboard until the dots are gone and the ■STOP button in the display flashes.

### 5 After you finish the performance, press the REGIST MEMORY [1] button to stop recording.

The Audio file will automatically be saved as “UserAudioxxx” (xxx is 001–100) to the USB flash drive. The file name is shown on the display.

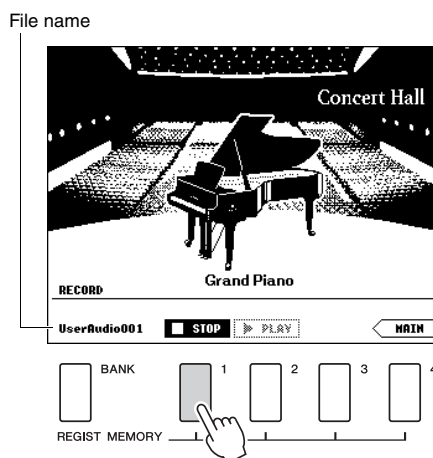

#### NOTE

- After recording is stopped, a moving series of dots (...) appear, indicating that saving is in progress.

### 6 To hear the recorded performance, press the REGIST MEMORY [2] button.

Press the REGIST MEMORY [2] button again to stop the playback.

### 7 Press the [EXIT] button to exit the Piano Room display.

## Playing back audio files recorded in the Piano Room

In the Piano Room, you can play back only the latest recorded audio file; other audio files recorded in the Piano Room can only be played back after exiting from the Piano Room. For information on playing back the Audio files, refer to “Playing Back a Song or Audio File” on page 39.

# Try Playing a Variety of Instrument Voices

In addition to the wonderfully realistic piano sounds, you can select and play other musical instrument Voices, such as organ, guitar, bass, strings, sax, trumpet, drums and percussion, and even sound effects.

## Selecting a Main Voice

This procedure selects the Main Voice for playing on the keyboard.

### 1 Press the [VOICE] button to call up the Main Voice selection display.

The current Voice number and name will be highlighted.

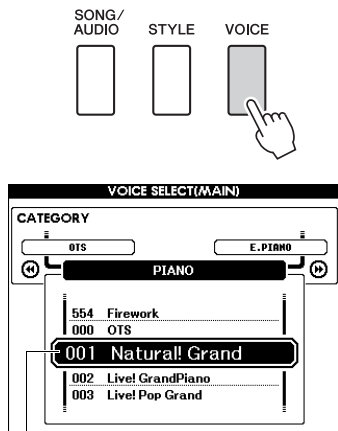

Current Voice number and name

### 2 Use the dial to select the desired Voice.

The Voice List is provided on the front panel, or in the separate Data List.

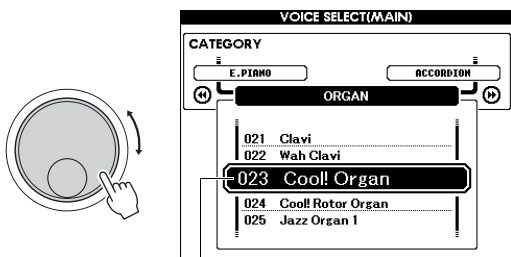

Select 023 Cool! Organ

### 3 Play the keyboard.

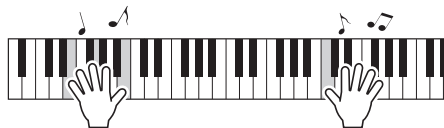

#### Preset Voice Types

001–151 167–554	Instrument Voices
152–166 (Drum Kit)	Various drum and percussion sounds are assigned to individual keys. Details on assigning instruments to keys are provided in the Drum Kit List of the separate Data List.
000	<b>One Touch Setting (OTS)</b> The One Touch Setting feature automatically selects the most suitable Voice for you when you select a Style or Song. Simply select Voice number “000” to activate this feature.

## Playing the “Grand Piano” (Piano Reset)

When you want to reset various settings to default and simply play a Piano sound, hold down the [PIANO ROOM] button for longer than a second.

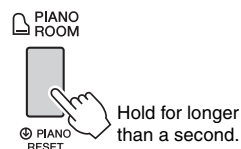

After a confirmation message appears on the display, press the [+] (YES) button to call up the default piano settings.

The Voice number is set to 001 “Natural! Grand Piano” and all other settings are turned off automatically, so only the Grand Piano Voice will play over the entire keyboard.

#### NOTE

- Keep in mind that this Piano Reset function is different from the Piano Room feature (page 25), even though the button is the same.
- This function cannot be used while the Piano Room display (pages 25, 26) is shown.

## Layering Two Voices—Dual Voice

In addition to the Main Voice, you can layer a different Voice over the entire keyboard as a “Dual Voice.”

- 1 Press the [DUAL ON/OFF] button to turn Dual on.

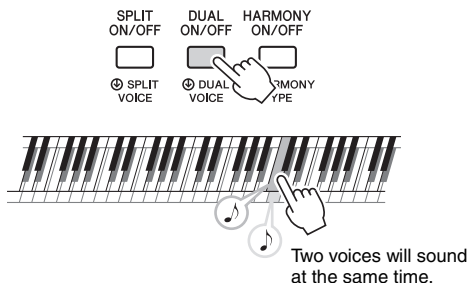

You can confirm whether the Dual function is on in the MAIN display.



Dual Voice number and name appear when Dual is on.

- 2 Press the [DUAL ON/OFF] button again to exit from Dual.

Although turning on Dual will select a Dual Voice suitable for the current Main Voice, you can easily select a different Dual Voice (page 60).

## Playing a Split Voice in the Left Hand area

By dividing the keyboard into two separate areas, you can play one Voice with your right hand and a different Voice with your left.

- 1 Press the [SPLIT ON/OFF] button to turn on Split.

The keyboard is divided into the left hand and right hand areas.

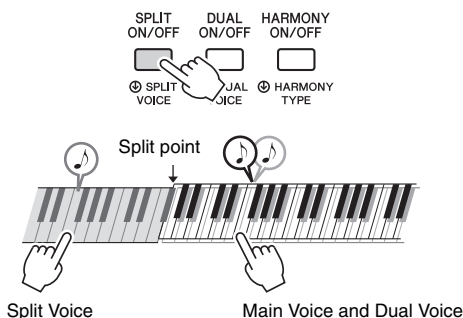

You can play a “Split Voice” on the left hand area of the keyboard while playing a Main Voice and Dual Voice on the right hand area of the keyboard. The highest key for the left hand area is referred to as the “Split Point” which can be changed from the default F#2 key. For details, refer to page 64.

You can confirm whether the Split function is on in the MAIN display.



Split Voice number and name appear when Split is on.

- 2 Press the [SPLIT ON/OFF] button again to exit from Split.

You can easily select a different Split Voice (page 60).

## Using the Metronome

The instrument features a built-in metronome (a device that keeps an accurate tempo), convenient for practicing.

- 1 Press the [METRONOME ON/OFF] button to start the metronome.

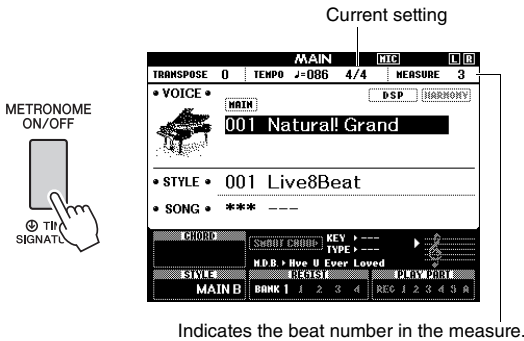

Indicates the beat number in the measure.

- 2 Press the [METRONOME ON/OFF] button again to stop the metronome.

## Adjusting the Metronome Tempo

Press the [TEMPO/TAP] button to call up the Tempo value, then use the dial to adjust the Tempo value.

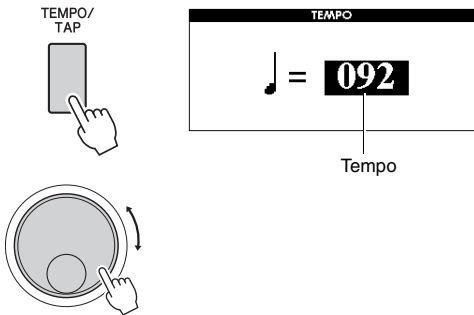

Press the [EXIT] button to exit the TEMPO display.

## Setting the Time Signature

Here, we'll set a time signature of 3/4 as an example.

**NOTE**

- The setting of the time signature cannot be changed in the Piano Room. Set it before calling up the Piano Room display.

- 1 Hold down the [METRONOME ON/OFF] button for longer than a second to call up "Time Signature - Numerator."

The time signature is shown on the display.

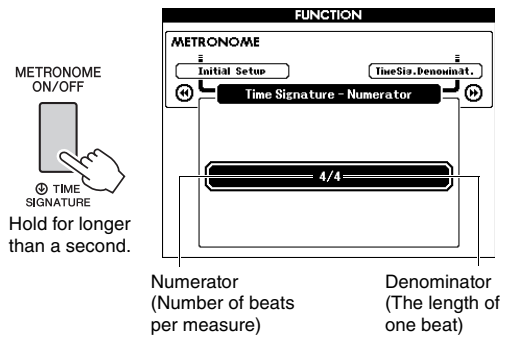

**NOTE**

- The metronome time signature will synchronize to a Style or Song that is selected, so these parameters cannot be changed while a Style or Song is playing.

- 2 Rotate the dial to select "3."
- A bell will sound on the first beat of each measure while the other beats will click.

- 3 Press the CATEGORY [▶▶] button to call up "Time Signature - Denominator."

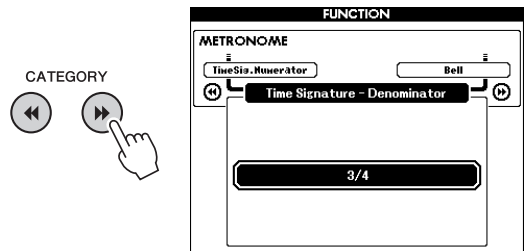

**4 Rotate the dial to select “4.”**

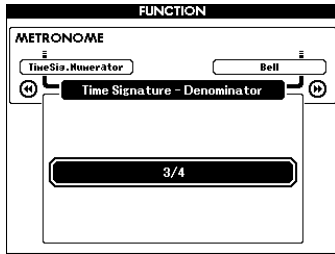

**5 Confirm the setting by playing the Metronome.**

**Setting the Metronome Volume**

**1 Press the [FUNCTION] button to call up the FUNCTION display.**

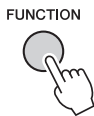

**2 Press the CATEGORY [◀◀] or [▶▶] buttons repeatedly to select “Metronome Volume.”**

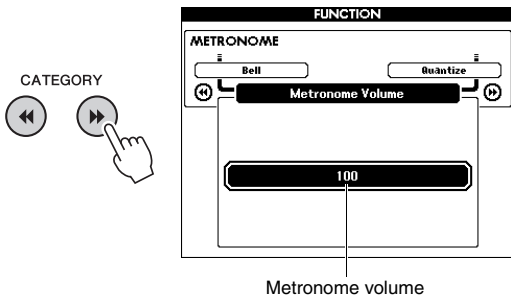

**3 Rotate the dial to set the Metronome Volume.**

**Setting the Bell sound**

This allows you to select whether the click sound has a bell accent, or plays only a click sound.

**1 Press the [FUNCTION] button.**

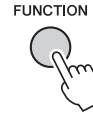

**2 Use the CATEGORY [◀◀] or [▶▶] button repeatedly to select “Bell.”**

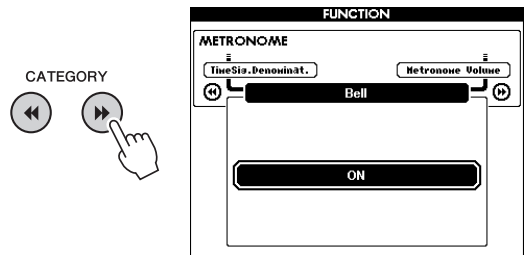

**3 Rotate the dial to turn the bell sound on or off.**

## Adding Harmony

You can add harmony notes to the Main Voice.

- 1 Press the [HARMONY ON/OFF] button to turn Harmony on.

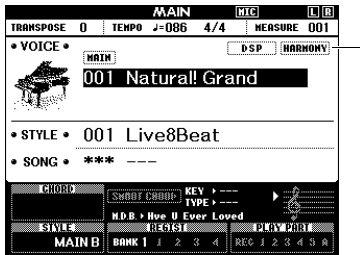
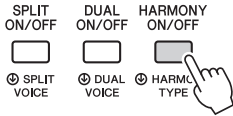

Appears when Harmony is turned on.

Although turning on the Harmony will select a Harmony Type suitable for the current Main Voice, you can select a different Harmony Type.

- 2 Hold down the [HARMONY ON/OFF] button for longer than a second until “Harmony Type” appears on the display.

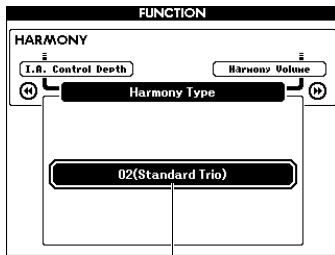
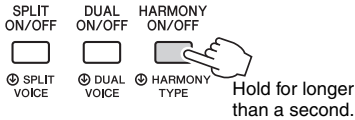

Current Harmony Type

- 3 Rotate the dial to select the desired Harmony Type.

For details, refer to the separate Data List. The effect and operation differs depending on the Harmony Type. Refer to the section below.

### How to sound each Harmony Type

#### Harmony type 01 to 10, 13



Press the right-hand keys while playing chords in the auto accompaniment range of the keyboard when the Auto Accompaniment is on (page 32).

#### Harmony type 11 (1+5) and 12 (Octave)



Play the keys.

#### Harmony type 14 (Multi Assign)



Both of the Main and Dual Voices should be turned on when using the Multi Assign effect. The Main and Dual Voices are alternately assigned to the notes in the order you play them.

#### Harmony type 15 to 18 (Echo)

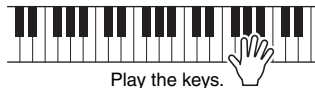

Play the keys.

#### Harmony type 19 to 22 (Tremolo)



Keep holding down the keys.

#### Harmony type 23 to 26 (Trill)



Hold down two keys.

You can adjust the Harmony Volume in the Function Settings (page 74).

# Playing Styles

The instrument features a variety of accompaniment and rhythmic backing patterns (called “Styles”) in a variety of different musical genres including pop, jazz, and many others. Each Style features Auto Accompaniment, letting you produce automatic accompaniment playback simply by playing “chords” with your left hand. This lets you automatically recreate the sound of a full band or orchestra — even if you’re playing by yourself.

## 1 Press the [STYLE] button to call up the STYLE selection display.

The current Style number and name is highlighted.

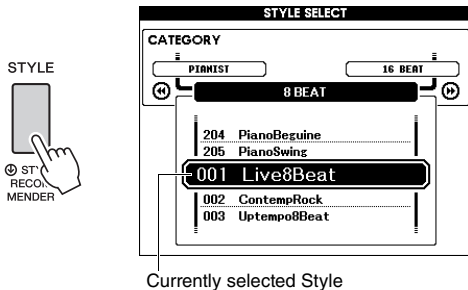

## 2 Use the dial to select the desired Style.

The Style List is provided on the front panel, or in the separate Data List.

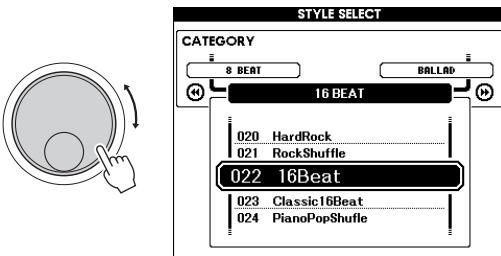

### NOTE

- You can also play the Styles in the instrument's flash memory area transferred from a computer (refer to “Computer-related Operations”—page 8) or loaded from a USB flash drive (page 86), and Styles on a USB flash drive connected to the instrument. These styles are numbered from 206 upward.

### Playing only the Rhythm Part

Pressing the [START/STOP] button starts playback of only the rhythm part. To stop playback, press the [START/STOP] button again.

Keep in mind that some Styles, such as “PIANIST” category Styles, have no rhythm part. These Styles produce no sound even if you press the [START/STOP] button. When you want to use any of these Styles, always execute step 3 and later so that all accompaniment parts will sound.

## 3 Press the [ACMP ON/OFF] button to turn on the Auto Accompaniment.

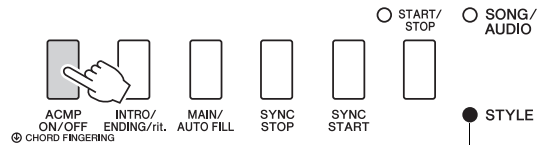

When this is on, the functions printed below the buttons are available.

## 4 Press the [EXIT] button to return to the MAIN display, then confirm whether the Auto Accompaniment is on.

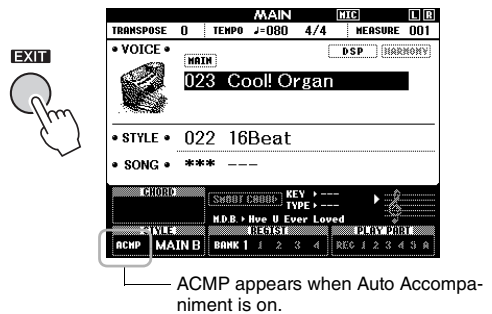

When the Auto Accompaniment is on, the keyboard area left to the Split Point (54: F#2) becomes the “Auto Accompaniment range” and is used only for specifying the chords.

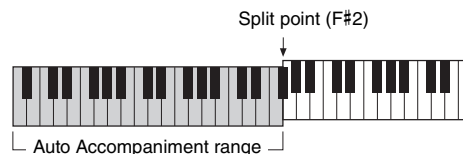

### NOTE

- The Split Point can be specified from the FUNCTION display. For details, refer to page 64.



**5 Press the [SYNC START] button to turn Synchro Start on.**

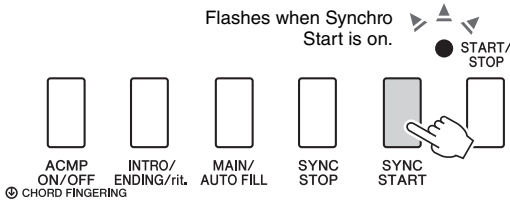

**6 Play a chord in the Auto Accompaniment range to start Style playback.**

Play a melody with your right hand and chords with your left.

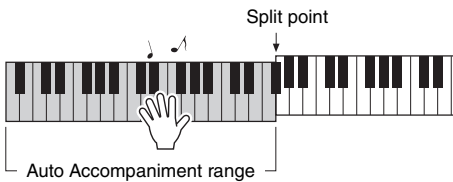

**Chord indication**

Chords being played in the Auto Accompaniment range will appear.



For information about chords, refer to “Chords” (page 34) or use the Chord Dictionary function (page 65).

You can adjust the volume of the Style playback. For details, see page 63.

**7 Press the [START/STOP] button to stop playback.**

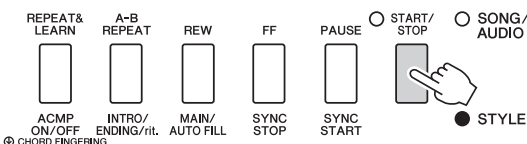

You can add intro, ending and rhythm variations to Style playback by using “Sections.” For details, refer to page 61.

**Using the Music Database**

If you have difficulty finding and selecting the desired Style and Voice, use this feature. From the Music Database, simply selecting your favorite music genre calls up the ideal settings.

**1 Press the [MUSIC DATABASE] button to call up the Music Database selection display.**

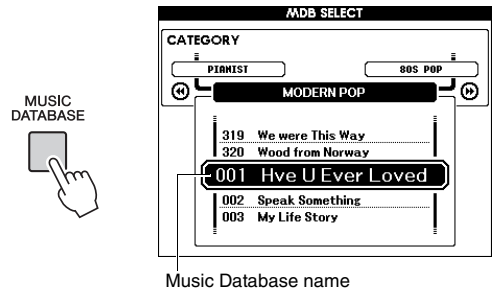

Both the Auto Accompaniment and Synchro Start are automatically turned on.

**2 Use the dial to select the desired Music Database.**

This operation calls up the panel settings such as Voice and Style that are registered to the selected Music Database. The Music Database List is provided in the separate Data List.

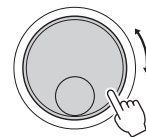

**3 Play the keyboard as described in Steps 6 to 7 in this page.**

## Chords

For users who are unfamiliar with chords, this chart shows the notes of common chords. Since there are many useful chords and many different ways to use them musically, refer to commercially available chord books for further details.

★ indicates the root note.

Major	Minor	Seventh	Minor Seventh	Major Seventh
<b>C</b> 	<b>Cm</b> 	<b>C7</b> 	<b>Cm7</b> 	<b>CM7</b> 
<b>D</b> 	<b>Dm</b> 	<b>D7</b> 	<b>Dm7</b> 	<b>DM7</b> 
<b>E</b> 	<b>Em</b> 	<b>E7</b> 	<b>Em7</b> 	<b>EM7</b> 
<b>F</b> 	<b>Fm</b> 	<b>F7</b> 	<b>Fm7</b> 	<b>FM7</b> 
<b>G</b> 	<b>Gm</b> 	<b>G7</b> 	<b>Gm7</b> 	<b>GM7</b> 
<b>A</b> 	<b>Am</b> 	<b>A7</b> 	<b>Am7</b> 	<b>AM7</b> 
<b>B</b> 	<b>Bm</b> 	<b>B7</b> 	<b>Bm7</b> 	<b>BM7</b> 

- A wide variety of chord types can be recognized as well as the above chord types.
- Depending on the chord type, inversions can be used as well as in "root" position.
- Some chord types may not be recognized if some notes are omitted.

### Easy Chords

This method lets you easily play chords in the accompaniment range of the keyboard using only one, two, or three fingers.

#### For a root of "C"



**To play a major chord**  
Press the root note (★) of the chord.



**To play a minor chord**  
Press the root note together with the nearest black key to the left of it.



**To play a seventh chord**  
Press the root note together with the nearest white key to the left of it.



**To play a minor seventh chord**  
Press the root note together with the nearest white and black keys to the left of it (three keys altogether).

### Changing the Chord Fingering type

There are three different Chord Fingering Types. For details, refer to page 64.

## Using the Smart Chord feature

If you want to fully enjoy playing in various Styles but don't know how to play the appropriate chords, Smart Chord is very useful. This function lets you control Styles with just a single finger as long as you know the key of your playing music, even if you don't know any chord fingering such as major, minor, diminished and so on. Appropriate chords suited for the music genre will sound whenever you press a single note, as if you were playing the "right" chords.

Key Signature (Key in F major)                      Chord Types

- 1 Select the Style which you want to play with, as described in steps 1–2 on page 32.
- 2 Press the [EXIT] button to return to the MAIN display.
- 3 Press the [SMART CHORD] button to turn on the Smart Chord function.

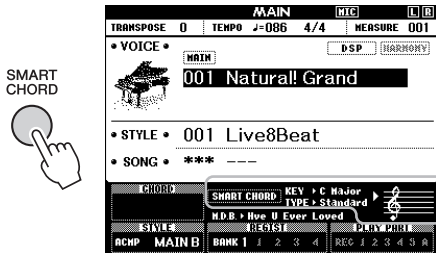

Indicates the current Smart Chord settings, KEY and TYPE when the Smart Chord is on.

**NOTE**  
 • Smart Chord can be turned on after pressing the [STYLE] button.

- 4 Hold down the [SMART CHORD] button until the SMART CHORD setting display appears.

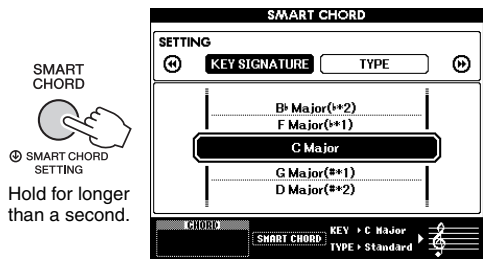

Hold for longer than a second.

- 5 On the KEY SIGNATURE page, use the dial to select the Key Signature. Make sure to select the Key Signature which is same as that on your music score, or your desired key for playing. Check the Key Signature indication at the right bottom corner of the display.

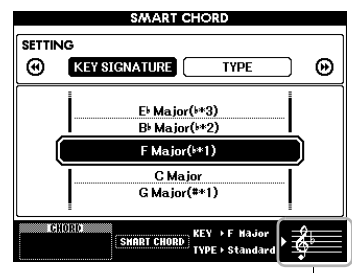

Indicates the selected Key Signature. Set this to the same as your music score.

Since the number of flats or sharps is shown to the right of Key Signature in the display, you can also find the desired Key Signature by counting the number of flats or sharps.

**TYPE Page:**

This page provides five Types of music genres which determine the specific chord assignment for each scale note in the Auto Accompaniment range. Although selecting a Style in step 1 will automatically set the optimum Type, you can select a different Type here for more appropriate results, if necessary. To do so, from the SMART CHORD display press the CATEGORY [▶▶] button to select the TYPE page then use the dial to select a Type.

The actual chord assignments are provided in the Smart Chord Chart in the separate Data List.

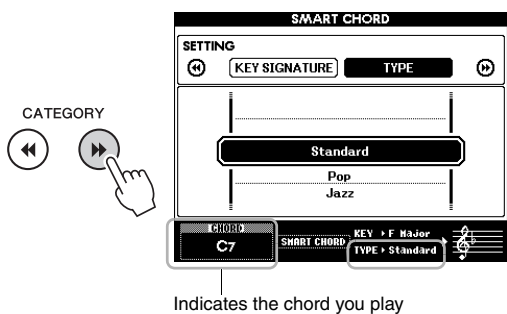

**NOTE**

- Each music type assumes only typical or conventional chord progression for the Style.
- The root of a chord shown at the bottom left of the display during Song recording may be different when the recorded Song is played back.

**6 Press the [SYNC START] button to turn Synchro Start on.**

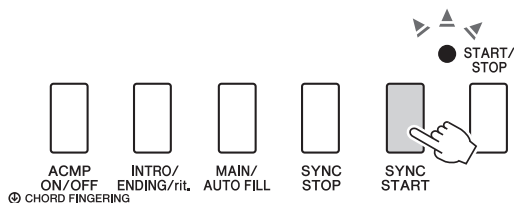

**7 According to the music score or the chord progression of your performance, play only the root key with the left hand.**

Pressing a key will start playback of the Style. You can try the chord progression F - F# - G - C - F - C in order referring to the score on page 35.

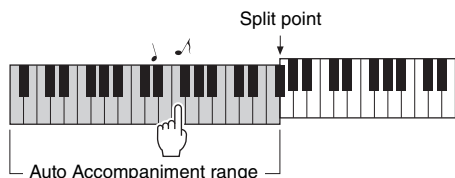

A sample score for the Smart Chord function is provided in the separate Data List.

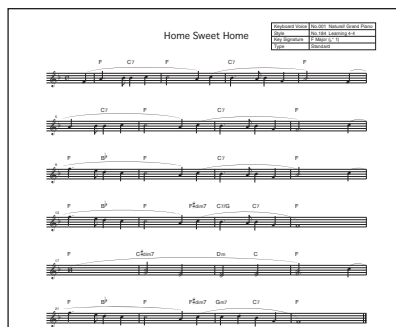

**8 Press the [SMART CHORD] button to turn off the Smart Chord function.**

## Calling up Optimum Styles for Your Performance (Style Recommender)

This convenient function “recommends” optimum Styles for your performance, based on the rhythm you play for one or two measures.

### 1 Hold down the [STYLE] button for longer than a second to call up the STYLE RECOMMENDER display.

The keyboard is divided by the B0 key into two sections (Drum and Piano) as shown below.

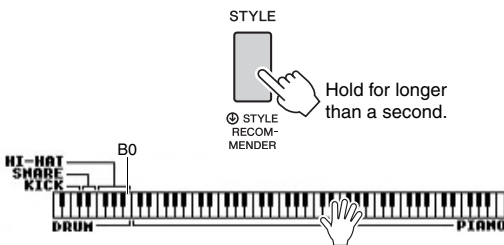

The Drum instruments (Kick, Snare and Hi-Hat) are assigned to the left-side section while the Piano sound is assigned to the right.

### 2 Search for the desired Style.

#### 2-1 Press the [START/STOP] button to start the metronome.

A “WAITING” indication appears in the display. As necessary, use the [+]/[-] buttons to select the beat, and use the [TEMPO/TAP] button to adjust the tempo (page 63).

#### 2-2 While “WAITING” is shown, play the rhythm you have in mind on the Drum or Piano section for one or two measures along with the metronome.

Below are two possible examples.

**Example 1: Play the following rhythm in the Piano section of the keyboard.**



Bossa Nova Styles or those of a similar feel may be listed on the display.

**Example 2: Play the following rhythm in the special Drum section of the keyboard.**



8-beat Styles or those of a similar feel may be listed on the display.

The timing at which you play the keys is analyzed over several seconds, then playback of the most recommended Style starts. In addition, the candidates of the other recommended Styles are listed in the display.



#### NOTE

- Only the note-on timing is analyzed. Tempo, pitches and note length are ignored.
- The recommended Style plays back according to the last chord played in the PIANO section. The PIANO section detects chords using the Fingering Chord type “FullKeyboard” (page 64).

### 3 Listen to the highest recommended Style, while playing chords in the PIANO section (as shown in step 1).

You can try out other Styles listed on the display by using the dial. If you cannot find the desired Style in the list, press the [STYLE] button, then return to step 2-2.

### 4 When you’ve found a Style you’re satisfied with, press the [EXIT] button to exit from the Style Recommender display.

### 5 Play the keyboard along with the Style you just found.

# Playing Songs and Audio Files

**There are two kinds of data that can be recorded and played back on this instrument: Songs and Audio files. Not only can you play back a Song or Audio file and listen to it, but you can also play the keyboard along with Song or Audio file playback.**

## • Songs

The Songs are organized by category as listed below, allowing you to easily select from the desired category. The numbers 001–100 are Preset Songs, and a complete list is provided in the separate Data List. The numbers 101–105 are Songs you’ve recorded on this instrument, and numbers from 106 upward are MIDI files in SMF (Standard MIDI File) format in this instrument’s flash memory and a USB flash drive connected to this instrument.

### SONG

- |         |                      |   |
|---------|----------------------|---|
| 001-003 | MAIN DEMO            | • Gives you an idea of the advanced capabilities of this instrument.  |
| 004-011 | VOICE DEMO           | • Demonstrates many useful Voices of this instrument.   |
| 012-037 | PIANO SOLO           | • These are piano solo pieces.  |
| 038-064 | PIANO ENSEMBLE       | • These are piano ensemble pieces.  |
| 065-074 | PIANO ACCOMPANIMENT  | • When you need to practice backing (accompaniment) patterns, these songs are ideal for that purpose.   |
| 075-093 | CLASSICAL MELODIES   | • Includes famous classical music pieces.   |
| 094-100 | TRADITIONAL MELODIES | • Includes traditional songs from around the world.   |
| 101-105 | USER SONG            | • Songs you’ve recorded on this instrument (page 44).   |
| 106-    | FLASH MEMORY / USB   | • Songs (MIDI files) in the instrument’s flash memory area transferred from a computer (refer to “Computer-related Operations”—page 8) or loaded from a USB flash drive (page 86), and Songs (MIDI files) on a USB flash drive connected to the instrument. |

#### NOTE

- Score data for the Preset Songs (exceptions are the Over View Demo Song and Songs 1–11) are provided in the Songbook, which is available as a free download from the website (page 8).

## • Audio files

Commercially available Audio files in WAV format (file extension: .wav with 44.1 kHz sample rate, 16 bit resolution, stereo) and your own recorded Audio files on a USB flash drive can be played back (page 49).

Availability of functions differs between Songs and Audio files. In this manual, the following icons indicate whether or not the explanation applies to Songs or Audio files individually.

Example: **SONG** **AUDIO** ... Indicates explanation applies only to Songs.

## Listening to the Overview Demo

This is a special demo for sound demonstrations and features. Press the [DEMO/BGM] button to start playback of the Overview Demo continuously, calling up the various displays in sequence.

DEMO/BGM



To stop playback, press the [DEMO/BGM] button or [START/STOP] button.

Please note that any Song-related functions with “**SONG**” cannot be applied to Overview Demo.

#### NOTE

- With the default setting, only one Demo is played back and repeated when the [DEMO/BGM] button is pressed. This setting can be changed so that all Preset Songs are played, or all Songs and Audio files on a USB flash drive are played. Five playback group settings are provided. Simply select the one that suits your needs (page 66).

## Playing Back a Song or Audio File

SONG

AUDIO

Before using a USB flash drive, be sure to read “Precautions when using the USB TO DEVICE terminal” on page 80.

- If you want to play back a Song or Audio file on a USB flash drive, connect a USB flash drive to the USB TO DEVICE terminal.

Audio files must be on a USB flash drive.

### Important

- In order to play a file on a USB flash drive, the file must be stored either in the USB flash drive’s root directory or a first-level/ second-level folder in the root directory. Files stored in third-level-folders created inside a second-level folder cannot be selected and played by this instrument.

USB flash drive (Root)

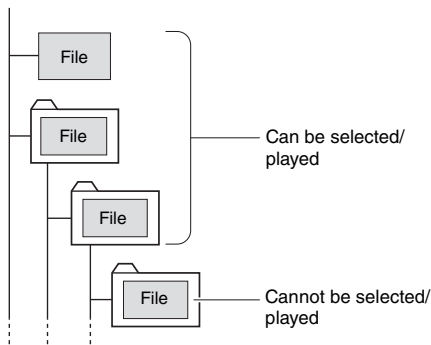

- Press the [SONG/AUDIO] button once or twice to call up the SONG SELECT display for Song selecting, or AUDIO SELECT display for Audio selecting.

The available Songs or Audio files are listed on the display.

If a USB flash drive is connected, pressing the [SONG/AUDIO] button repeatedly toggles between two displays: SONG SELECT and AUDIO SELECT. If a USB flash drive is not connected, this operation calls up only SONG SELECT display.

### SONG SELECT display

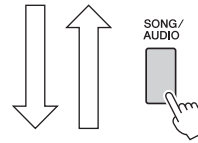
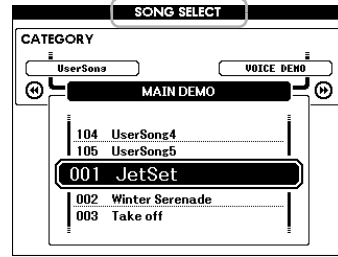

### AUDIO SELECT display

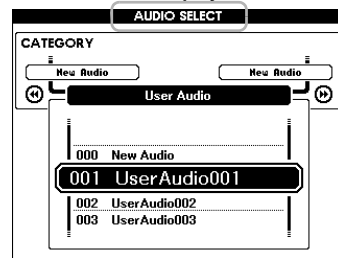

- Use the dial to select the desired Song or Audio file.

When selecting Songs, refer to the list on page 38.

- Press the [START/STOP] button to start playback.

To stop playback, press the [START/STOP] button again.

When this is on, the functions printed above the buttons are available.

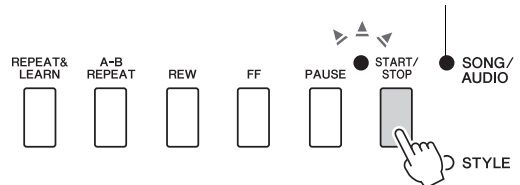

You can adjust the Song volume (page 67) and Audio volume (page 67).

## Adjusting the Tempo of a Song

Same procedure as with Style tempo. See page 63.

### NOTE

- The tempo of audio playback cannot be changed.

## Fast Forward, Rewind, and Pause

SONG

AUDIO

This instrument lets you fast forward [FF], rewind [REW] and pause [PAUSE] playback of the Song or Audio file.

When this is on, the functions printed above the buttons are available.

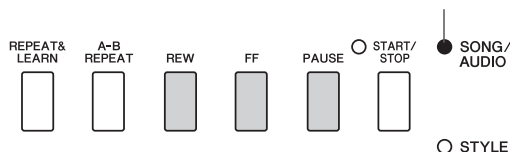

Pressing the [REW] or [FF] button once moves one measure backward/forward for Songs, or one second for Audio files. Holding one of them scrolls backward/forward continuously. Press the [PAUSE] button to pause playback, and press again to start from that point.

## A-B Repeat

SONG

AUDIO

You can specify a desired section of a Song and repeatedly play back that section by setting the A point (start point) and B point (end point).

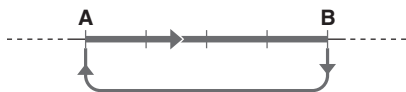

- 1 Start playback of the Song (page 39).
- 2 When playback reaches to the point you want to specify as the start point, press the [A-B REPEAT] button to set the A point.

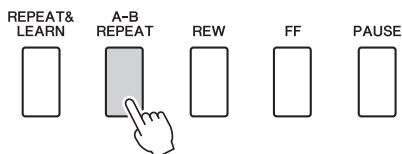

- 3 When playback reaches to the point you want to specify as the end point, press the [A-B REPEAT] button again to set the B point.

The specified A-B section of the Song will now play repeatedly.

- 4 To cancel repeat playback, press the [A-B REPEAT] button.

To stop playback, press the [START/STOP] button.

**NOTE**

- If you want to set the start point "A" at the top of the Song, press the [A-B REPEAT] button before starting playback.

## Turning Each Track On/Off

SONG

AUDIO

Each "track" of a Song plays a different part—melody, percussion, accompaniment, etc. Each of the tracks can be muted so that you can play the muted part yourself. Pressing the desired Track button repeatedly will toggle the on/off status.

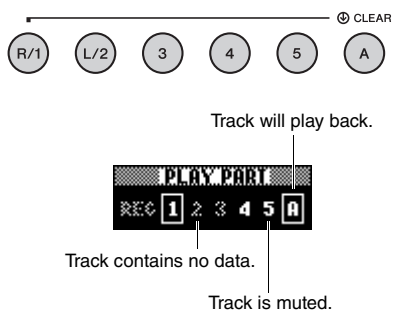

**NOTE**

- Up to two Track buttons can be pressed simultaneously for turning on or off.



## Displaying the Song Score

SONG

AUDIO

You can view the music notation (score) of the selected Song.

- 1 Select a Song (steps 1–3 on page 39).
- 2 Press the [SCORE] button to call up the Score display.

Pressing this button each time alternates the displayed notation style between single-staff and double-staff.

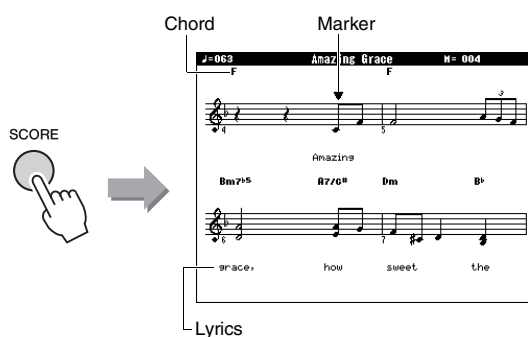

Both chords and lyrics will be shown in single-staff score display of a Song that includes chords and lyric data.

- 3 Press the [START/STOP] button to start Song playback.

The marker moves to indicate the current position.

If the Song parts are muted at this point you will be able to hear only the sound of your own performance so that you can play the Song yourself while reading the score. Refer to page 40 for more information on Song muting.

**NOTE**

- When there are many lyrics, they may be displayed in two rows a measure, and/or some lyrics or chords may be abbreviated.
- Small notes that are hard to read may be easier to read after you use the Quantize function (page 75).
- No chords or lyrics are shown on the double-staff display.

- 4 Press the [EXIT] button to return to the MAIN display.

## Displaying the Lyrics

SONG

AUDIO

When the selected Song contains lyric data, you can view it on the instrument's display during playback.

- 1 Select Song 38 (steps 1–3 on page 39), which is the only internal Song that provides lyric display.
- 2 Press the [LYRICS] button to call up the Lyrics display.

The title, lyricist, and composer of the Song will appear on the display.

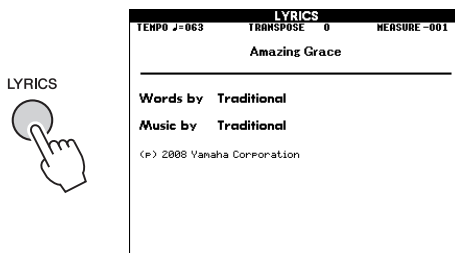

- 3 Press the [START/STOP] button.

The Song will play back while the lyrics and chords are shown on the display. The lyrics will be highlighted to show the current location in the Song.

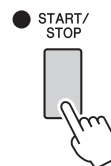

**NOTE**

- Commercially available Song files, including XF format files (page 10), are compatible with the Lyrics display features as long as they are standard MIDI file format files containing lyric data. Lyrics display may not be possible with some files.

- 4 Press the [EXIT] button to return to the MAIN display.

# Using the Song Lesson Feature

You can use the selected Song for a left-hand, right-hand, or both-hands lesson. Try practicing with these three Song Lesson types.

## Three Types of Song Lesson

### Lesson 1—Waiting

In this Lesson, try playing the correct notes shown on the display. The Song pauses until you play the right note.

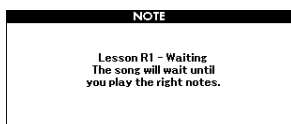

### Lesson 2—Your Tempo

In this Lesson, try playing the correct notes shown on the display with the correct timing. The Song playback tempo will change to match the speed at which you are playing at.

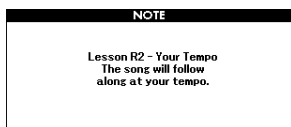

### Lesson 3—Minus One

Here's where you can perfect your technique. The Song will play at the normal tempo, minus the part you have chosen to play. Play along while listening to the Song.

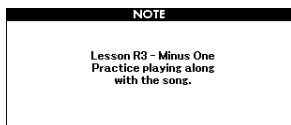

## Practicing with Song Lesson

### 1 Select the desired Song for your lesson (page 39).

#### NOTE

- Audio files cannot be used with the Lesson features.

#### NOTE

- The Song Lesson features can be applied also to User Songs and Songs (SMF format 0 and 1) on a USB flash drive or transferred/loaded to the instrument (pages 84 and 86).

### 2 Press the [EXIT] button to return to the MAIN display.

### 3 Select the part you want to practice.

Press the [R/1] button for a right-hand lesson, [L/2] button for a left-hand lesson, or press both the [R/1] and [L/2] buttons simultaneously for a both-hands lesson. The currently selected part is shown in the upper right corner of the display.

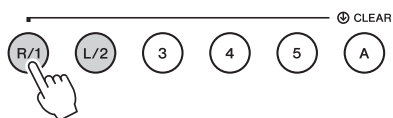

- R** : Right-hand lesson
- L** : Left-hand lesson
- L R** : Both-hands lesson



#### 4 Press the desired LESSON START button, [WAITING], [YOUR TEMPO] or [MINUS ONE] to start playback of the Song Lesson.

Play the notes shown in the on-screen score. The score marker and keyboard marker in the display will indicate the notes to play.

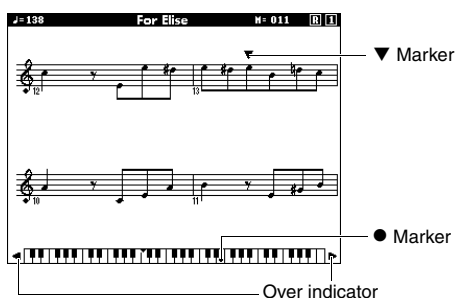
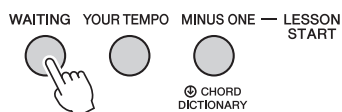

#### NOTE

- The notes in the on-screen score may be shown an octave higher or lower (or more) depending on the Voice used in the Song.
- Since the display has restrictions, the on-screen score may appear somewhat different from commercially available scores. When using the Lesson function, also make sure to refer to the notes shown in the on-screen keyboard at the bottom of the display. You can adjust the score appearance on the Lesson display by changing the Quantize parameter in the Score category in the Function List (page 75).

#### Shifting the on-screen keyboard left or right.

If the Over indicator appears, the hidden ( ) areas of the keyboard can be brought into view by pressing the [+] or [-] button. Notes that actually fall outside the keyboard's range cannot be used in the lesson.

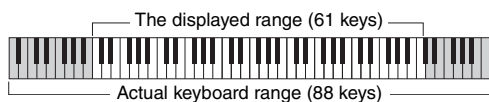

To stop Lesson playback, press the [START/STOP] button. Even during playback, you can change the Lesson number by pressing the [WAITING], [YOUR TEMPO] or [MINUS ONE] button.

#### 5 When Lesson playback reaches the end, check your evaluation Grade on the display.

Your performance will be evaluated in four levels: OK, Good, Very Good, or Excellent. After the evaluation display has appeared, the lesson will start again from the beginning.



#### NOTE

- The evaluation feature can be turned off via the FUNCTION "Grade" item (page 75).

## Making Practice Perfect—Repeat & Learn

If you want to practice a specific section in which you made a mistake or you have difficulty with use the Repeat & Learn function.

#### Press the [REPEAT & LEARN] button during Lesson playback.

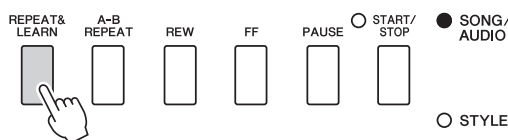

The Song location will move back four measures, a one-measure count will play, then Song playback will start again. Playback of the four measures will repeat with a one-measure count-in.

To exit from this status, press this button again.

#### NOTE

- You can change the amount of measures the Repeat & Learn function jumps back by pressing a number button [1] to [9] during repeat playback.

# Recording Your Performance

This instrument allows you to record your performance in the following two methods.

## • Song recording (MIDI recording)

With this method, recorded performances are saved to the instrument as a User Song, in SMF (format 0) MIDI file. If you want to re-record a specific section or edit parameters such as Voice, use this method. Also if you want to record your performance to each track one by one, execute “Recording to a Specified Track” of the Song recording method. Since a User Song can be converted to an Audio file after recording (page 85), you may want to use Song recording (with individual track recording) to first create a complex arrangement you would not otherwise be able to play live, then convert it to an Audio file. Up to approximately 30,000 notes can be recorded for one User Song.

## • Audio recording (page 49)

With this method, recorded performances are saved to a USB flash drive as an Audio file. Recording is done without designating the recorded part. Since it is saved in stereo WAV format of normal CD quality resolution (44.1kHz/16bit) by default, it can be transmitted to and played on portable music players by using a computer. This instrument allows you to record up to 80 minutes per single recording.

## Song Recording

SONG

AUDIO

You can record up to five of your performances and save them as User Song 101 through 105. This operation is for recording a new Song from scratch. If you want to re-record a specific track, execute “Recording to a Specified Track” on page 46.

### NOTE

- Split Voice, Metronome, the AUX IN sound and MIC INPUT sound cannot be recorded.

1 Press the [SONG/AUDIO] button once or twice to call up the SONG SELECT display for Song recording.

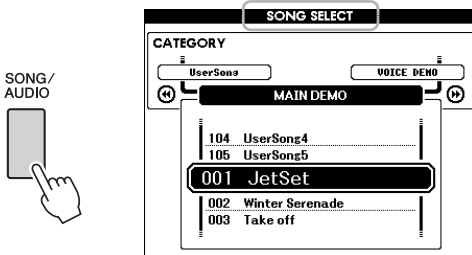

If a USB flash drive is connected, pressing the [SONG/AUDIO] button repeatedly toggles between two displays: SONG SELECT and AUDIO SELECT. If a USB flash drive is not connected, this operation calls up only SONG SELECT display.

You can select the desired User Song with the dial.

2 If you want to record with a Style, press the [STYLE] button then the [ACMP ON/OFF] button to turn ACMP on.

Once you have set the ACMP to ON, don't call up the SONG SELECT or AUDIO SELECT display because doing so will set the ACMP to OFF.

3 Press the [REC] button to enable recording.

If a User Song was not selected beforehand, this operation selects the lowest-numbered unrecorded User Song (from 101–105) as the Recording target.

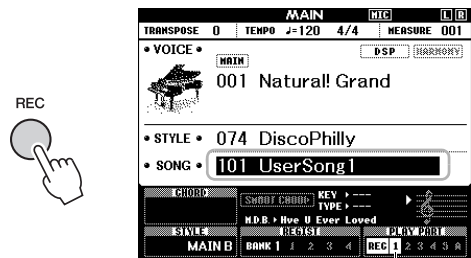

Track 1 (and A) is automatically selected for recording.

To cancel recording, press the [REC] button or [EXIT] button.

### NOTICE

- If all User Songs (Song numbers 101–105) contain recorded data, Song 101 will automatically be selected. In this case, you will record over and erase any previous data of this Song.

**NOTE**

- You can use the Metronome while recording although the metronome sound will not be recorded. After pressing the [REC] button, set the Time Signature and start Metronome before going on to step 4.

**4 Play the keyboard to start recording.**

You can also start recording by pressing the [START/STOP] button.



The current measure will be shown on the display during recording.



Current measure

**5 After you finish performance, press the [START/STOP] button or [REC] button to stop recording.**

When recording is stopped, a message asking if you want to save the Song will appear.

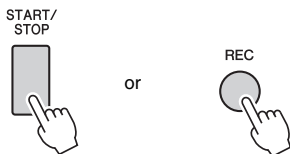
**NOTICE**

- The recorded Song will be lost if you turn the power off without executing the save operation.

**6 Press the [+] (YES) button to save the Song.**

The Song will be stored as a MIDI file to Song number 101–105. To cancel saving, press the [-] (NO) button at the prompt.

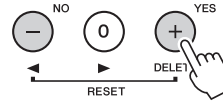
**NOTICE**

- Never attempt to turn the power off when a “Now Writing...” message is shown in the display. Doing so can damage the flash memory and result in a loss of data.

**7 To hear the newly recorded performance, press the [START/STOP] button.****NOTE**

- If you press the [-] (NO) button once in response to the confirmation message, you have the option of saving the Song later until the power is turned off or another Song is selected. To do this hold down the [REC] button until the save confirmation message appears, then press the [+] (YES) button.

**Data that cannot be recorded to Songs**

AUX IN sound, Microphone sound, Metronome sound, Damper Resonance effect, Split Voice, Damper Resonance ON/OFF, Master EQ Type, Output Gain, I.A.Control, I.A.Control Depth, MDB, Song Volume, Transpose, Tuning, Split Point

**Data that cannot be changed during the Song recording**

Style Number, ACMP ON/OFF, Smart Chord setting, Style Volume, Chord Fingering, Touch Response, Time Signature

## Recording to a Specified Track

SONG

AUDIO

With Song Recording, you can create a Song consisting of six tracks (1–5 and A) by recording your performance to each track one by one. In recording a piano piece, for example, you can record the right-hand part to Track 1 then record the left-hand part to Track 2, allowing you create a complete piece which may be difficult to play live with both hands together. To record a performance with Style playback, for example, record the Style playback to Track A, then record melodies to Track 1 while listening to the already recorded Style playback. In this way, you can create an entire Song which would otherwise be difficult, or even impossible, to play live.

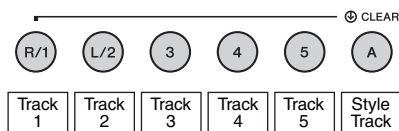

**Tracks [1]–[5]** For recording your keyboard performances, such as a piano piece.

**Track [A]** For recording Style playback.

### NOTE

- Split Voice, Metronome, AUX IN sound and MIC INPUT sound cannot be recorded.

Before recording, make the necessary settings such as Voice/Style selection.

- 1 If you want to re-record an existing User Song, select the desired User Song. (Execute step 1 on page 44 then select the User Song from 101–105 using the dial.)

If you want to record from scratch, select the unrecorded User Song.

- 2 To specify the target track, while holding down the [REC] button, press one track button from [1]–[5] or [A].

To cancel recording to a specified track, press that track button again.

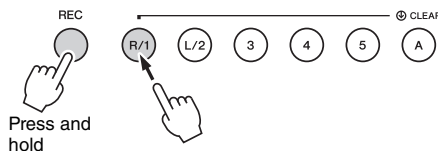

To record your keyboard performance, specify from [1] to [5]. (To record the Dual Voice specify from [1] to [3].)

To record the Style playback, specify [A]. (ACMP is automatically turned on.)

The selected track will be highlighted in the display.

**(When Track 1 is specified)**



Track 1 will be highlighted

**(When Track A is specified)**



Track A will be highlighted

When Track A is specified, you can specify one more track from [1]–[5] by repeating this step, and vice versa.

To cancel recording, press the [REC] button or [EXIT] button.

### NOTICE

- If you record to a track that contains previously recorded data, the previous data will be overwritten and lost.

### NOTE

- If Auto Accompaniment is on and Track [A] has not yet been recorded, Track [A] will automatically be selected for recording when one of Tracks ([1]–[5]) is selected. If you only want to record to Track [1]–[5], be sure to turn Track [A] off.
- If the User Song selected in step 1 already contains recorded Style data, the same Style number is automatically set. If you want to select another Style, press the [STYLE] button then use the dial to select the desired Style after specifying the [A] track.

### NOTE

- You can use the Metronome while recording although the metronome sound will not be recorded. After pressing the [REC] button, set the Time Signature and start Metronome before going on to step 3.

### 3 Play the keyboard to start Recording.



### 4 After you finish the performance, press the [START/STOP] button or [REC] button to stop recording.

When recording is stopped, a message asking if you want to save the Song appears.

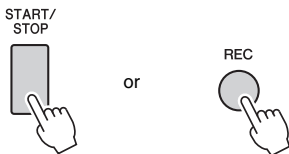

#### NOTICE

- The recorded performance will be lost if you turn the power off without executing the Save operation.

### 5 Press the [+] (YES) button to save the Song.

The Song will be stored as a MIDI file to Song number 101–105. To cancel saving, press the [-] (NO) button at the prompt.

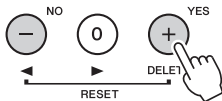

The recorded track numbers in the display will be shown in a box border.



#### NOTICE

- Never attempt to turn the power off when a “Now Writing...” message is shown in the display. Doing so can damage the flash memory and result in a loss of data.

### 6 To hear the newly recorded performance, press the [START/STOP] button.

### 7 Record your performance to another track by repeating steps 2–6.

In step 2, select a track which has no recorded data. Play the keyboard while listening to the already recorded data.

You can record to each track [1]–[5] using different Voices. Before specifying the target track, press the [VOICE] button and select the desired Voice, then press the [EXIT] button.

#### NOTE

- When recording another track, you can turn already recorded tracks on or off using the track buttons.

See page 45 for information on data that cannot be recorded to the Songs or cannot be changed during Song recording.

## Clearing a User Song

SONG

AUDIO

You can clear all tracks of a User Song.

- 1 Press the [SONG/AUDIO] button, and then select the User Song (101 to 105) to be cleared.
- 2 While holding down the track [A] button, press the track [1] button for longer than a second.

A confirmation message will appear on the display.

To cancel this operation, press the [-] (NO) button.

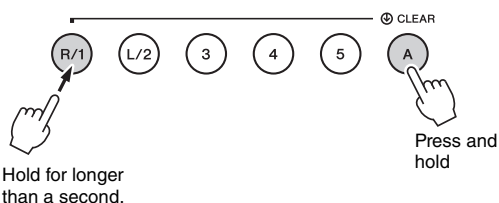

- 3 Press the [+] (YES) button to clear the Song.

A clear-in-progress message will appear briefly on the display.

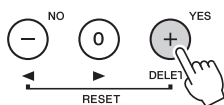

## Clearing a Specified Track from a User Song

SONG

AUDIO

This lets you clear individual tracks from a User Song.

- 1 Press the [SONG/AUDIO] button, and then select the desired User Song (101 to 105).
- 2 From [1] to [5] and [A], press the Track button to be cleared for longer than a second.

A confirmation message will appear on the display.

To cancel this operation, press the [-] (NO) button.

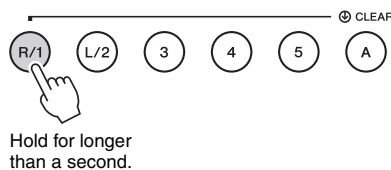

- 3 Press the [+] (YES) button to clear the track.

A clear-in-progress message will appear briefly on the display.

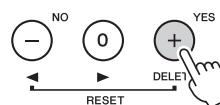



## Audio Recording

SONG

AUDIO

Before recording, make the necessary settings such as Voice/Style selection and the AUX IN and MIC INPUT connections (if you want to record with the input sound via AUX IN and MIC INPUT jacks). All the sound produced via this instrument other than Metronome can be recorded.

### NOTICE

- Don't use the file name “\_DGX-660\_TMP.wav” in the USB flash drive because the file with the name will be overwritten and erased by newly recording Audio data.

### 1 Connect the USB flash drive to the USB TO DEVICE terminal.

Before using a USB flash drive, be sure to read “Precautions when using the USB TO DEVICE terminal” on page 80.

### 2 Press the [SONG/AUDIO] button once or twice to call up the AUDIO SELECT display for Audio recording.

If a User Audio file was not selected beforehand, this operation selects a new Audio file as recording target.

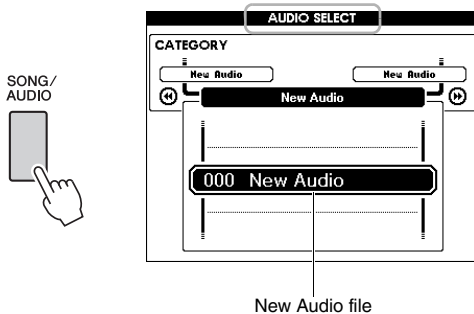

### 3 As necessary, select the Audio file for recording target.

If multiple Audio files are in the USB flash drive and the wrong file is selected by mistake, you can select a different file by using the dial. If you want to create a new Audio file, select “000 New Audio.”

### NOTICE

- If you record to Audio file that contains previously recorded data, the previous data will be overwritten and lost.

### 4 Press the [REC] button to be ready for recording.

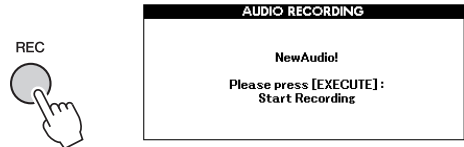

If you want to cancel recording, press the [REC] button again or [EXIT] button.

### 5 Press the [EXECUTE] button to start recording, then play the keyboard.

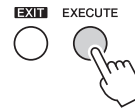

The elapsed recording time is shown in the MAIN display while recording.

### NOTICE

- Never attempt to disconnect the USB flash drive or turn the power off during recording. Doing so may corrupt the USB flash drive data or the recording data.

### 6 After you finish the performance, press the [EXECUTE] button or [REC] button to stop recording.

The Audio file will automatically be saved as “UserAudioxxx” (xxx is 001–100) in a folder labeled “USER FILES” which will automatically be created on the USB flash drive.

To delete the User Audio files 001–100, perform “USB Delete” described on page 87.

### 7 To hear the recorded performance, press the [START/STOP] button.

# Memorizing Your Favorite Panel Settings

This instrument has a Registration Memory feature that lets you memorize your favorite settings for easy recall whenever they're needed. Up to 32 complete setups can be saved (eight banks of four setups each).

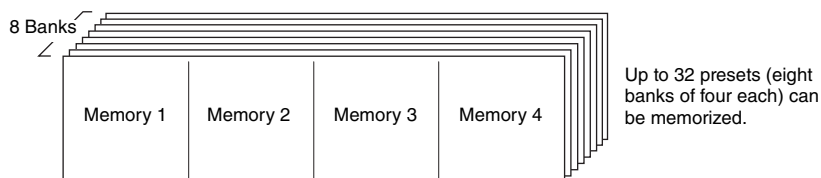

## Memorizing Panel Settings to the Registration Memory

- 1 Make the desired settings such as those for Voice and Style.
- 2 Press and release the [BANK] button to call up a Bank number on the display.

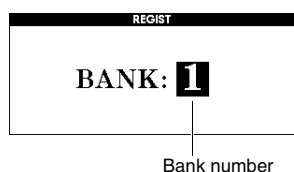
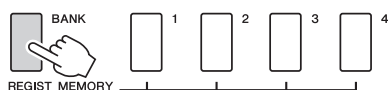

- 3 Use the dial to select a Bank number.

### NOTE

- Data cannot be saved to the Registration Memory during Song playback.

- 4 While holding down the [BANK] button, press one of the REGIST MEMORY [1] to [4] buttons to memorize the current panel settings.

You can check the Registration Memory status in the MAIN display; Memory numbers that contain data light up, and a border appears around the selected one.

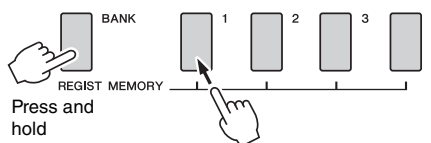

### NOTICE

- If you select a Registration Memory number that already contains data, the previous data is deleted and overwritten by the new data.
- Do not turn off the power while memorizing settings to the Registration Memory, otherwise the data may be damaged or lost.

## Recalling Panel Settings from the Registration Memory

- 1 Press and release the [BANK] button to call up a Bank number on the display.

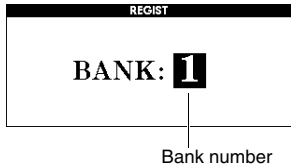
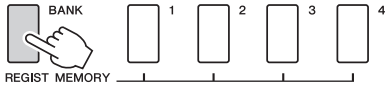

- 2 Use the dial to select a Bank number.
- 3 Press one of the REGIST MEMORY [1] to [4] buttons to call up the panel settings you memorized.

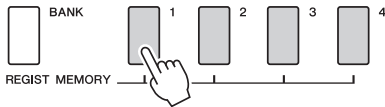

You can check the Registration Memory status in the MAIN display (page 23).

### Settings that are Saved to the Registration Memory

#### Style settings\*

Style number, Auto Accompaniment on/off, Split Point, Style settings (Main A/B), Style Volume, Tempo, Chord Fingering, Smart Chord on/off, Smart Chord Setting

#### Voice settings

Main Voice setting (Voice number and all settings of the related Functions)

Dual Voice settings (Dual on/off, Voice number and all settings of the related Functions)

Split Voice settings (Split on/off, Voice number and all settings of the related Functions)

#### Effect settings

Reverb Type, Chorus Type, Panel Sustain on/off, DSP on/off, DSP Type

#### Harmony settings

Harmony on/off and all settings of the related Functions

#### Other settings

Transpose, Pitch Bend Range, Assignable Pedal, Portamento Time

\* Style settings are not available for Registration Memory when using the Song/Audio features.

# Backup Parameters and Initialization

## Backup Parameters

The following data will be maintained even if the power is turned off and can be transferred then saved to a computer via Musicsoft Downloader as a single Backup file. For instructions, refer to “Computer-related Operations” (page 8).

### Backup Data

- Piano Room settings (Refer to page 25 for details.)
- Registration Memory data (page 50)
- Microphone settings (Refer to page 71 for details.)
- Function Settings (page 72):
  - Tuning, Split Point, Touch Sensitivity, Style Volume, Song Volume, Wireless LAN Volume, Metronome Volume, Grade, Demo Group, Demo Play mode, Demo Cancel, Panel Sustain, Master EQ type, Chord Fingering, Auto Power Off setting, Damper Resonance ON/OFF, Output Gain, I.A. Control ON/OFF, I.A. Control Depth, Audio Volume, AUX IN Level, Portamento Time, Assignable Pedal
- Wireless LAN settings (page 77)

In addition to the Backup data above, all the User Songs and all the Song and Style files transferred from a computer or loaded from a USB flash drive will be maintained even if you turn off the power.

To initialize Backup data, execute “Clearing Backup data.”

To initialize data (excluding Backup data) transferred from a computer or loaded from a USB flash drive, execute “Clearing files in flash memory area.”

## Initialization

This function erases the Backup data described above and Song/Style data, then restores all the default factory settings. As required, execute one of the following two procedures.

### Clearing Backup data

This operation initializes the backup data.

While holding down the highest white key on the keyboard, press the [⏻] (Standby/On) switch to turn the power on. Make sure to hold down the key until the message appears at the top left of the display.

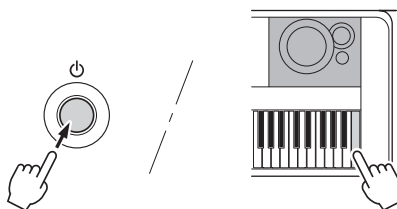

### Clearing files in flash memory area

This operation deletes all User Songs and all the Songs and Styles that have been transferred from a computer or loaded from a USB flash drive. While simultaneously holding the highest white key and the three highest black keys, press the [⏻] (Standby/On) switch to turn the power on. Make sure to hold down the keys until the message appears at the top left of the display.

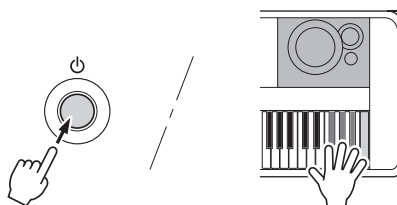

### NOTICE

- *Keep in mind that this operation also deletes the data you have purchased. Be sure to save the important data to a computer via Musicsoft Downloader (MSD) software. For details, refer to “Computer-related Operations” (page 8).*

# Handy Performance Features

## Selecting a Reverb Type

The Reverb effect lets you play with a rich concert hall type ambience. Although selecting a Style or Song will call up the optimum Reverb type for the entire sound, you can select a different Reverb type manually.

- 1 Press the [FUNCTION] button.

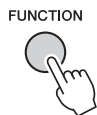

- 2 Use the CATEGORY [◀◀] and [▶▶] buttons to call up “Reverb Type.”

The current Reverb type is shown below.

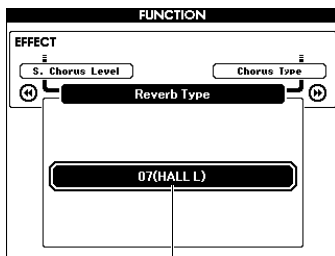

Current Reverb type

### NOTE

• Some Songs and Styles use Reverb Types which cannot be selected via panel operations. If such a Song or Style is played back, “- -” is shown on the display. In such a case, you can select Reverb type 01 using the [+] or [-] button.

- 3 Rotate the dial to select a Reverb type.

Play the keyboard to check the sound. For information about the available Reverb types, refer to the Effect Type List in the separate Data List.

### Adjusting the Reverb Level

You can adjust the Reverb level applied to the Main, Dual, and Split Voices individually via the same operations above. Regarding the item in Step 2, refer to the Function List on page 73.

## Selecting a Chorus Type

The Chorus effect creates a thick sound that is similar to many of the same Voices being played in unison. Although selecting a Style or Song will call up the optimum Chorus type for the entire sound, you can select a different Chorus type manually.

- 1 Press the [FUNCTION] button.

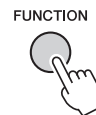

- 2 Use the CATEGORY [◀◀] and [▶▶] buttons to call up “Chorus Type.”

The current Chorus type is shown.

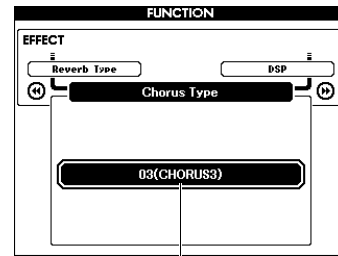

Current Chorus type

### NOTE

• Some Songs and Styles use Chorus Types which cannot be selected via panel operations. If such a Song or Style is played back, “- -” is shown on the display. In such a case, you can select Chorus type 01 using the [+] or [-] button.

- 3 Rotate the dial to select a Chorus type.

Play the keyboard to check the sound. For information about the available Chorus types, refer to the Effect Type List in the separate Data List.

### Adjusting the Chorus Level

You can adjust the Chorus level applied to the Main, Dual, and Split Voices individually via the same operations above. Regarding the item in Step 2, refer to the Function List on page 73.

## Selecting a DSP Type

DSP is an abbreviation of Digital Signal Processing. These range from reverb-like ambience effects to distortion and other dynamic processing tools that let you enhance the sound, or completely transform it. The DSP effect can be added to the Main and Dual Voices. Although ON/OFF status and type selection for DSP depends on a selected Main Voice, you can set these parameters manually.

### 1 Press the [FUNCTION] button.

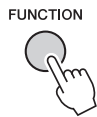

**NOTE**

- The volume of the currently playing Voice changes when turning DSP on or off. This is not a malfunction. The amount of change differs depending on the selected Voice.
- The DSP type is an overall setting—only one type can be selected. For this reason, when you play a newly loaded Song or Style, for example, the currently playing Voices may not sound as expected. This is normal, since the Song or Style has its own DSP type which replaces any selection you’ve made before loading. A similar phenomenon occurs when you use the [FF], [REW] buttons or A-B Repeat function during Song playback.

### 2 Use the CATEGORY [◀◀] and [▶▶] buttons to call up “DSP.”

The current setting is displayed.

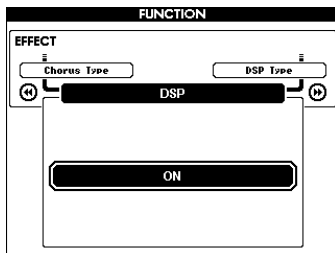

### 3 Use the dial to turn DSP on.

Press the [EXIT] button to return to the MAIN display in order to check the DSP on/off status.

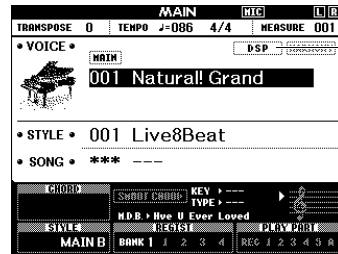

Appears when DSP is on

### 4 Press the [FUNCTION] button.

### 5 Use the CATEGORY [◀◀] and [▶▶] buttons to call up “DSP Type.”

The currently selected DSP type will be displayed.

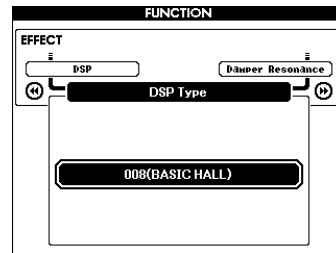

### 6 Use the dial to select a DSP type.

For information about the available DSP types, refer to the Effect Type List in the separate Data List.

#### Adjusting the DSP Level

You can adjust the DSP level applied to the Main and Dual Voices individually via the FUNCTION display. Refer to “\*\* DSP Level” in the Function List (page 73).

## Panel Sustain

This function adds sustain to the keyboard voices. Use it when you want to add sustain to the voices at all times, regardless of footswitch operation. The sustain function does not affect the Split Voice.

- 1 Press the [FUNCTION] button.

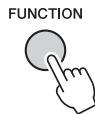

- 2 Use the CATEGORY [◀◀] and [▶▶] buttons to call up “Sustain.”

The current setting is displayed.

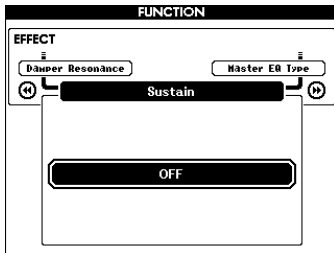

- 3 Use the dial to turn panel sustain on or off.

**NOTE**

- The sustain of some Voices may not be obviously or audibly affected when the panel sustain function is turned on.

## Pitch Controls—Transpose

The overall pitch of the instrument (except for the Voices with name “\*\*\* Kit”) can be shifted up or down by a maximum of 1 octave in semitone increments.

- 1 Press the [FUNCTION] button.

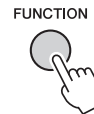

- 2 Use the CATEGORY [◀◀] and [▶▶] buttons to call up “Transpose.”

The current setting is displayed.

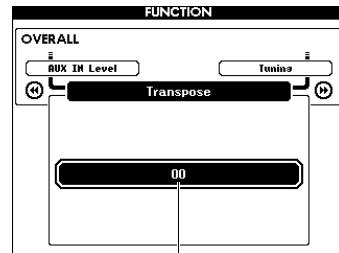

Current Transpose value

- 3 Use the dial to set the Transpose value between -12 and +12.

## Pitch Controls—Tuning

The overall tuning of the instrument (except for the Voices with name “\*\*\* Kit”) can be shifted up or down between 415.3 Hz and 466.2 Hz in approximately 0.2Hz or 0.3Hz increments. The default value is 440.0 Hz.

1 Press the [FUNCTION] button.

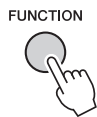

2 Use the CATEGORY [◀◀] or [▶▶] buttons to call up “Tuning.”

The current setting is displayed.

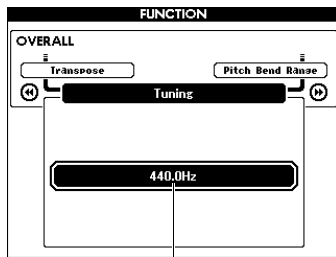

Current value

3 Use the dial to set the Tuning value.

## Pitch Controls—the PITCH BEND wheel

The PITCH BEND wheel can be used to add smooth pitch variations to notes you play on the keyboard. Roll the wheel upward to raise the pitch, or downward to lower the pitch. You can change the amount of pitch bend produced by the wheel. Refer to “Pitch Bend Range” in the Function List (page 73).

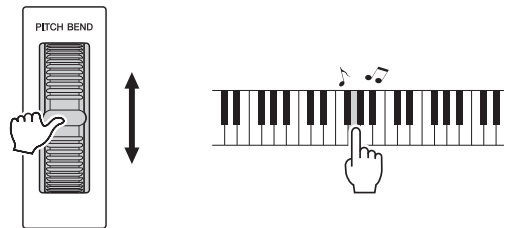

**NOTE**

- The pitch may not be raised to the designated value depending on the selected Voice.
- The effects produced by using the PITCH BEND wheel may not be applied to the Split Voice when the [ACMP ON/OFF] is ON.



## Touch Response Sensitivity

The keyboard of this instrument is equipped with a Touch Response feature that lets you dynamically and expressively control the level of the Voices according to your playing strength.

1 Press the [FUNCTION] button.

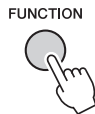

2 Use the CATEGORY [◀◀] or [▶▶] button to select “Touch Response.”

The current Touch Response sensitivity is displayed.

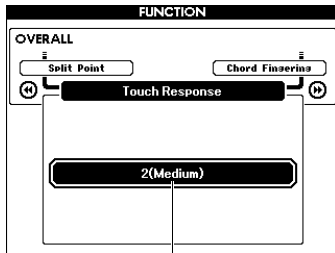

Current Touch Response sensitivity

3 Use the dial to select one of the Touch Response sensitivity settings (1–4).

When “1 (Soft),” “2 (Medium)” or “3 (Hard)” is selected, Touch Response is active. When “4” (Fixed) is selected, all notes will be played at the same volume no matter how strongly or softly you play the keys.

1 (Soft)	With a soft touch, the instrument produces a loud sound. The volume level of tones tends to be consistent.
2 (Medium)	Standard touch response.
3 (Hard)	You must hit the key very hard to generate a loud volume. This allows for versatile expression, from pianissimo to fortissimo tones.
4 (Fixed)	No touch response. The volume level will be the same regardless of how hard you play the keys.

**NOTE**

- The initial default Touch Response Sensitivity value is “2.”

## Selecting an EQ Setting for the Best Sound

Five different master equalizer (EQ) settings are provided to give you the best possible sound. Master Equalizer is EQ processing that is applied to the overall sound (except Audio) which is finally output from the Effect block to the speakers or headphones.

1 Press the [FUNCTION] button.

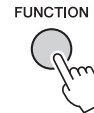

2 Press the CATEGORY [◀◀] or [▶▶] button several times until “Master EQ Type” appears.

The current Master EQ type is displayed.

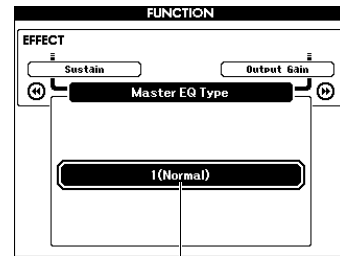

Current Master EQ type

3 Use the dial to select the desired Master EQ type.

1 (Normal)	Flat EQ settings.
2 (Piano)	Optimum for piano solo performance.
3 (Soft)	Lowers the high range for a softer sound.
4 (Bright)	Lowers the mid range for a brighter sound.
5 (Powerful)	Features more powerful sound.

**NOTE**

- “5 (Powerful)” produces a more punchy sound but may produce distortion depending on the Voice and Style, compared to the other Master EQ types.

## Setting the Output Gain Level

Output gain level for the PHONES/OUTPUT jack can be switched among three values: one suitable for a headphone and the other two for a connected external audio device.

- 1 Press the [FUNCTION] button.

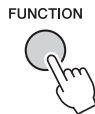

- 2 Press the CATEGORY [◀◀] or [▶▶] button several times until “Output Gain” appears.

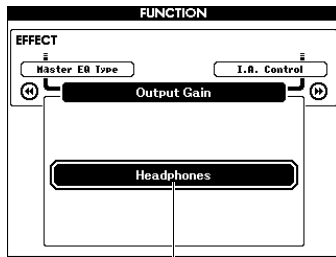

Current setting

- 3 Use the dial to select the desired setting (below).

Headphones	Select this when using headphones. The output gain level is set to an optimum value headphones connection. When “Headphones” is selected and external audio equipment is connected to the PHONES/OUTPUT jack, distortion may be produced.
Line Out	Select this when using external audio equipment. The output gain level can be adjusted by the [MASTER VOLUME] control of the instrument.
Fixed	Select this when using external audio equipment. The output gain level is fixed at the same level, regardless of the position of instrument’s [MASTER VOLUME] control.

## Speaker On/Off Setting

You can set whether the sound of this instrument is always output from its built-in speaker or not when a plug is inserted to the PHONES/OUTPUT jack.

- 1 Press the [FUNCTION] button.

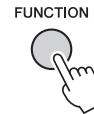

- 2 Press the CATEGORY [◀◀] or [▶▶] button several times until “Speaker Control” appears.

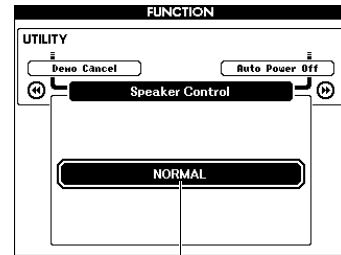

Current setting

- 3 Use the dial to select the desired setting.

When “NORMAL” is selected the speakers are automatically shut off when a plug is inserted into the PHONES/OUTPUT jack. When “ALWAYS ON” is selected the speaker sound is always on regardless of whether a plug is inserted or not.

## Intelligent Acoustic Control (IAC)

IAC is a function which automatically adjusts and controls the sound quality according to the overall volume of the instrument. Even when the volume is low, it permits both low sounds and high sounds to be clearly heard. IAC is effective only from the sound output of the instrument speakers. Although the default settings of IAC is set to ON, you can turn the function on or off. In addition, you can set the depth of IAC.

- 1 Press the [FUNCTION] button.

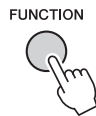

- 2 Press the CATEGORY [◀◀] or [▶▶] button several times until "I.A. Control" appears.

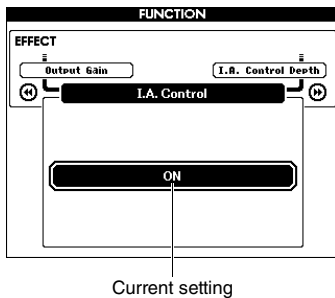

- 3 Use the dial to turn IAC on or off.

## Setting IAC Depth

You can adjust the depth of the IAC effect.

- 1 Press the [FUNCTION] button.

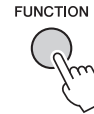

- 2 Press the CATEGORY [◀◀] or [▶▶] button several times until "I.A. Control Depth" appears.

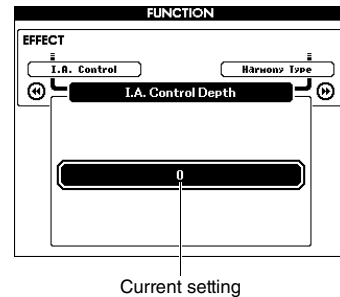

- 3 Use the dial to set the desired value.

The setting range is from -3 to 3. The higher the value, the deeper the effect.

# Voice Settings

## Selecting a Dual Voice

- 1 Hold down the [DUAL ON/OFF] button for longer than a second to call up the “VOICE SELECT (DUAL)” display.

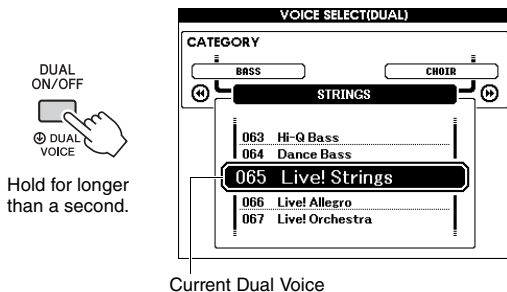

- 2 Rotate the dial to select the desired Dual Voice.

## Selecting a Split Voice

- 1 Hold down the [SPLIT ON/OFF] button for longer than a second to call up the “VOICE SELECT (SPLIT)” display.

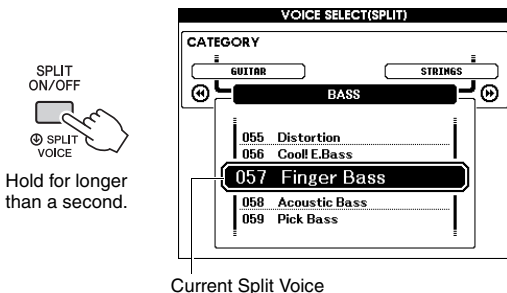

- 2 Rotate the dial to select the desired Split Voice.

## Voice Editing

For each of the Main, Dual and Split Voices, you can edit the parameters such as volume, octave and depth of the Reverb and Chorus, allowing you to create new, custom sounds that best suit your musical needs.

- 1 Press the [FUNCTION] button.

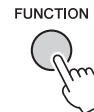

- 2 Use the CATEGORY [◀◀] or [▶▶] buttons to call up the desired item.

Main Voice parameters are indicated as “Main \*\*\*,” Dual Voice parameters as “Dual \*\*\*,” and Split Voice parameters as “Split \*\*\*.” For information about each parameter, refer to the Function List on page 73.

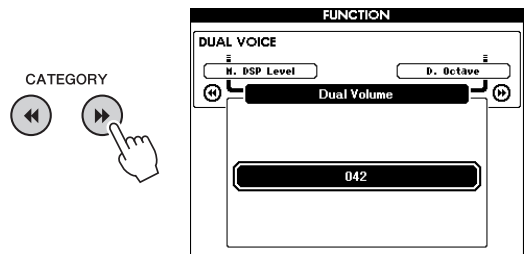

- 3 Rotate the dial to set the value.  
Check the sound by playing the keyboard.
- 4 Repeat Steps 2–3 above to edit various parameters.
- 5 If necessary, memorize the settings to the Registration Memory (page 50).

The Voice-related settings are reset when a different Voice is selected. If you want to store the created sound for future recall, memorize the settings to the Registration Memory.

# Style (Auto Accompaniment) Functions

## Style Variations—Sections

Each Style consists of “Sections” that allow you to vary the arrangement of the accompaniment to match the performance you are playing.

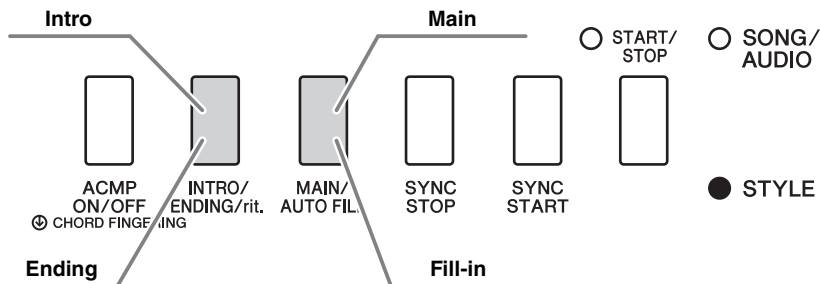

### Intro

This is used for the beginning of the performance. When the Intro finishes, Style playback shifts to the Main section. The length of the Intro (in measures) differs depending on the selected Style.

### Main

This is used for playing the main part of the performance. Playback of the Main section repeats indefinitely until another Section’s button is pressed. There are two variations (A and B), and the Style playback sound changes harmonically in response on the chords you play with your left hand.

### Fill-in

This is automatically added before changing to Main A or B.

### Ending

This is used for the ending of the performance. When the Ending finishes, Style playback stops automatically. The length of the Ending (in measures) differs depending on the selected Style.

- 1 Press the [STYLE] button, then rotate the dial to select a Style.
- 2 Press the [EXIT] button to return to the MAIN display.
- 3 Press the [ACMP ON/OFF] button to turn ACMP on.



Appears when ACMP is turned on.

- 4 Press the [SYNC START] button to turn Synchro Start on.

The indicator flashes when Synchro Start is on.

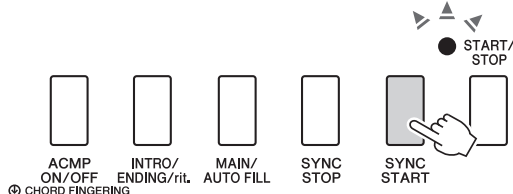

### Synchro Start

When Synchro Start is on, Style playback will begin as soon as you play a chord in the Auto Accompaniment range of the keyboard. Pressing the [SYNC START] button alternately turns Synchro Start on or off.

5 Press the [MAIN/AUTO FILL] button to select Main A or Main B.

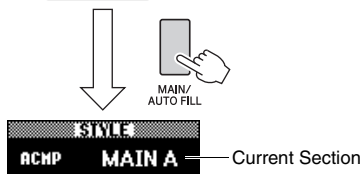

6 Press the [INTRO/ENDING/rit.] button.



Now, you're ready to start Style playback from the Intro section.

7 Play a chord with your left hand to start playback of the Intro.

For this example, play a C major chord (as shown below). For information on how to enter chords, see "Chords" on page 34.

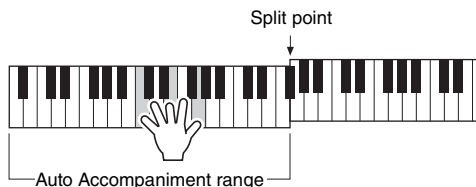

8 After the Intro finishes, play the keyboard according to the progression of the performance you are playing.

Play chords with your left hand while playing melodies with your right hand, and press the [MAIN/AUTO FILL] button as necessary. The Section will change to Fill-in then Main A or B.



9 Press the [INTRO/ENDING/rit.] button.



The Section switches to the Ending. When the Ending is finished, Style playback stops automatically. You can have the Ending gradually slow down (ritardando) by pressing the [INTRO/ENDING/rit.] button again while the Ending is playing back.

### Syncho Stop

When you press the [SYNC STOP] button to turn on this function, the Style will only play while pressing chords in the Auto Accompaniment range of the keyboard. Releasing all the notes will stop Style playback. This makes it easy to add rhythmic breaks as you perform, simply by releasing your hand from the Auto Accompaniment range of the keyboard.

Pressing the [SYNC STOP] button alternately turns Syncho Stop on or off.

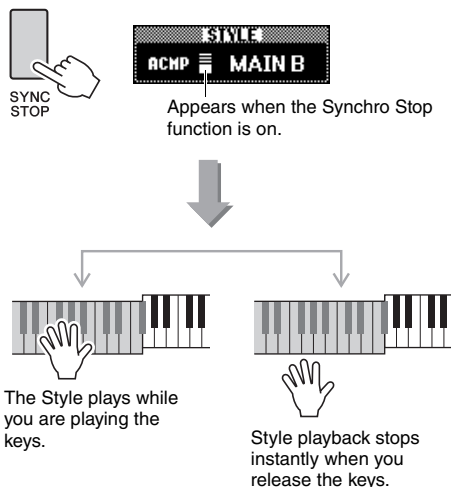

## Changing the Tempo

A Style can be played at any tempo you desire—fast or slow.

- 1 Press the [TEMPO/TAP] button to call up the Tempo display.

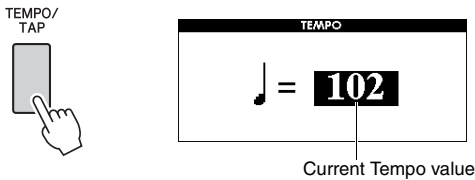

- 2 Rotate the dial to set a tempo.

Press the [+] and [-] buttons simultaneously to instantly reset the value to the default tempo of the current Style. You can change the tempo during playback by pressing the [TEMPO/TAP] button just twice at the required tempo.

**NOTE**

- The above operation applies also to Song playback tempo.

## Tap Start

You can start play back of the Style or Song by simply tapping the [TEMPO/TAP] button at the required tempo—four times for time signatures in 4 (4/4, etc.), and three times for time signatures in 3 (3/4, etc.).

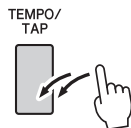

## Adjusting the Volume of the Style

You can adjust the volume balance between Style playback and keyboard performance.

- 1 Press the [FUNCTION] button.

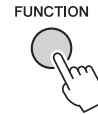

- 2 Use the CATEGORY [◀◀] and [▶▶] buttons to call up “Style Volume.”

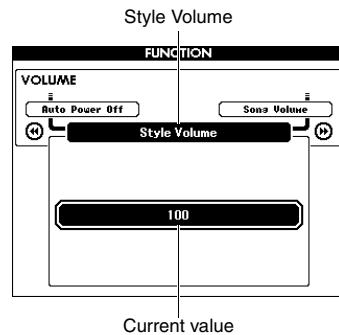

- 3 Rotate the dial to set the volume.

## Playing Chords Without Style Playback (Stop Accompaniment)

If you press the [STYLE] button, press the [ACMP ON/OFF] button to turn ACMP on (the ACMP ON icon appears), and play the chord in the left hand range of the keyboard (with SYNC START off), the chord sound will be heard without Style playback. This is referred to as “Stop Accompaniment.” The specified chord will be shown in the display, and affects the Harmony function (page 31).

## Setting the Split Point

The point on the keyboard that separates the left-hand range and the right-hand range of the keyboard is called the “Split Point.”

When a Style is selected and ACMP is on, the notes played to the left of the Split Point are used to specify the chord for Style playback. When the Split function is on, the notes played to the left of the Split Point are used to play the Split Voice.

The initial default Split Point is key number 54 (the F#2 key), but you can change it to another key.

### 1 Press the [FUNCTION] button.

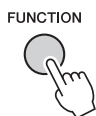

### 2 Use the CATEGORY [◀◀] and [▶▶] buttons to call up “Split Point.”

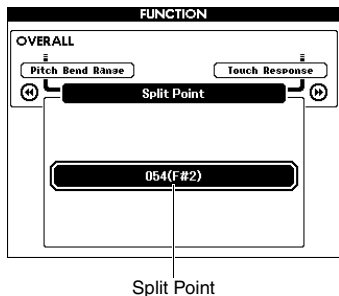

### 3 Rotate the dial to set the Split Point between 021 (A-1) and 108 (C7).

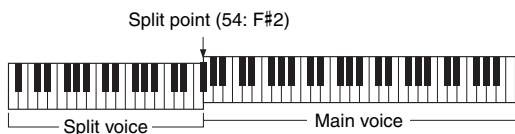

To restore the value to the default setting, press [+]/[-] buttons simultaneously.

**NOTE**

- The Split Point set here is applied to both the Style and Voice.
- During the Lesson playback, the Split Point cannot be changed.

## Setting the Chord Fingering

There are three different Fingering Types which let you specify the chord type for Style playback or use the entire keyboard range for chord specifying.

- 1 Press the [STYLE] button.
- 2 Holding down the [ACMP ON/OFF] button for longer than a second to call up the “Chord Fingering” display.

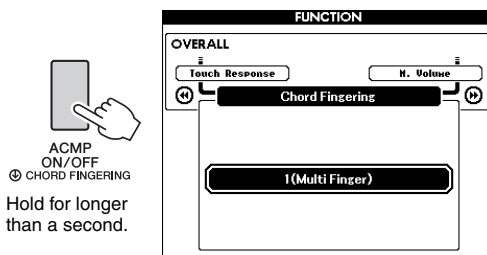

### 3 Use the dial to select the desired setting.

1 (Multi Finger)	Recognizes the various chord types which are listed on the separate Data List, including “Easy Chords” (this book, page 34).
2 (FullKeyboard)	Detects chords in the entire key range. Chords are detected in a way similar to 1 (Multi Finger), even if you split the notes between your left and right hands — for example, playing a bass note with your left hand and a chord with your right, or by playing a chord with your left hand and a melody note with your right. In this mode, Easy Chords cannot be detected.
3 (All Fingered)	Less than three notes can be played to indicate the chords (based on the previously played chord, etc.).



## Looking Up Chords Using the Chord Dictionary

The Dictionary function is useful when you know the name of a certain chord and want to quickly learn how to play it.

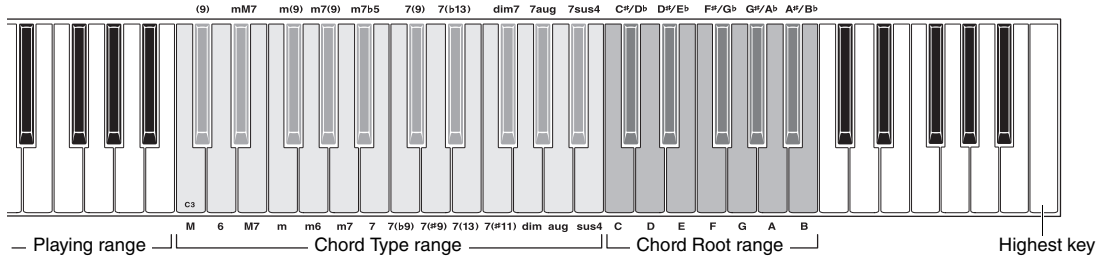

1 Press and hold the [MINUS ONE] button for longer than a second to call up the **DICTIONARY** display.

2 As an example, learn how to play a **GM7** (G major seventh) chord.

2-1 Referring to the illustration, press the G key in the “Chord Root” range so that “G” is shown as the root note (no sound will be produced).

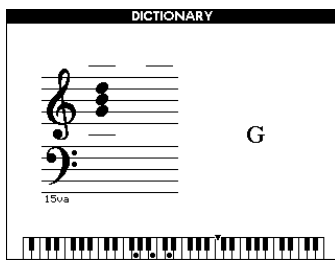

2-2 Referring to the illustration, press the M7 (major seventh) key in the “Chord Type” range (no sound will be produced). The notes you should play for the specified chord (root note and chord type) are shown in the display, both as notation and in the keyboard diagram.

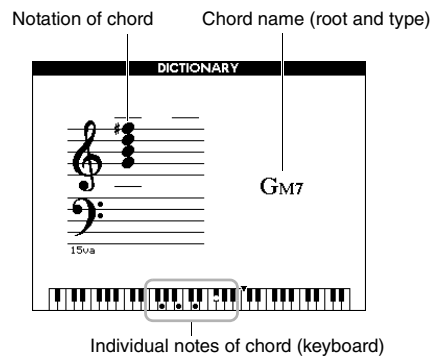
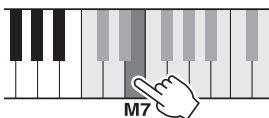

To call up possible inversions of the chord, press the [+]/[-] buttons.

**NOTE**

- About major chords: Simple major chords are usually indicated only by the root note. For example, “C” refers to C major. However, when specifying major chords here, make sure to select “M” (major) after pressing the root note.

3 Following the notation and keyboard diagram in the display, try playing a chord in the “Playing” range.

When you’ve played the chord properly, a bell sound signals your success and the chord name in the display will be highlighted.

To exit from this function, press the [EXIT] button.

# Song and Audio Settings

## Background Music (BGM) Playback

With the default setting, pressing the [DEMO/BGM] button will play back only Overview Demo Song repeatedly. This setting can be changed so that, for example, all internal Songs are played, or all Songs and Audio files on a USB flash drive are played back, letting you use the instrument as a background music source. Five playback group settings are provided. Simply select the one that suits your needs.

- 1 Hold down the [DEMO/BGM] button for longer than a second to call up the “Demo Group” display.

The current repeat playback target is shown.

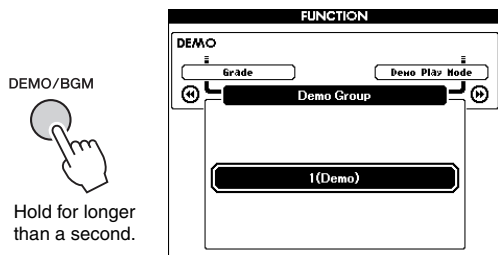

- 2 Rotate the dial to select a repeat playback group from the table below.

1 (Demo)	Overview Demo Song
2 (Preset)	All preset Songs
3 (User)	All User Songs
4 (Download)	All Songs transferred from a computer
5 (USB)	All Song files (MIDI files) and Audio files in the connected USB flash drive.  <b>Playback Order</b> Since the files in the root folder on a USB flash drive will be sorted in alphabetical order regardless of the file type, you can alternately playback several Songs and Audio files in order as in this example:
	Song1.mid Song1.wav Song2.mid Song2.wav  To do so, please make sure only the files to be played back are in the root folder on a USB flash drive and there are no other files in the USB flash drive.

- 3 Press the [DEMO/BGM] button to start playback.

To stop playback, press the [DEMO/BGM] button again.

## Random Playback

The order of repeat playback via the [DEMO/BGM] button can be changed between numerical and random order.

- 1 Press the [FUNCTION] button.

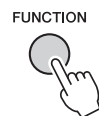

- 2 Press the CATEGORY [◀] or [▶] buttons several times to select “Demo Play Mode.”

The current playback mode, “1 (Normal)” or “2 (Random),” is shown.

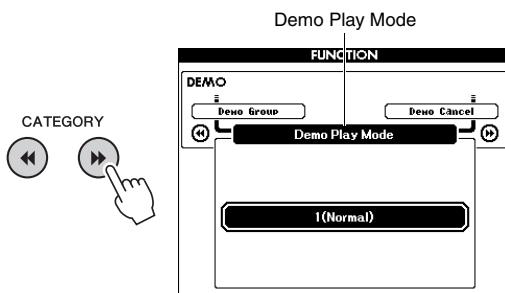

When the “Demo Group” is set to “1 (Demo),” this parameter cannot be set.

- 3 Rotate the dial to select “2 (Random).”  
To return to numerical order, select “1 (Normal).”
- 4 Press the [DEMO/BGM] button to start playback.  
To stop playback, press the [DEMO/BGM] button again.

## Tempo Setting of the Song

This operation is same as that of the Style. Refer to page 63.

### Tap Start

This operation is same as that of the Style. Refer to page 63.

## Song Volume

**NOTE**

- Song volume can be adjusted while a Song is selected.

### 1 Press the [FUNCTION] button.

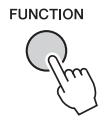

### 2 Press the CATEGORY [◀◀] or [▶▶] buttons several times to call up “Song Volume.”

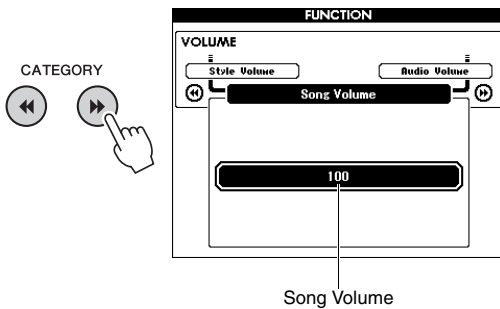

### 3 Rotate the dial to set the Song volume.

## Audio Volume

**NOTE**

- Audio volume can be adjusted while an Audio file is selected.

### 1 Press the [FUNCTION] button.

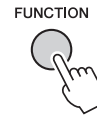

### 2 Press the CATEGORY [◀◀] or [▶▶] buttons several times to call up “Audio Volume.”

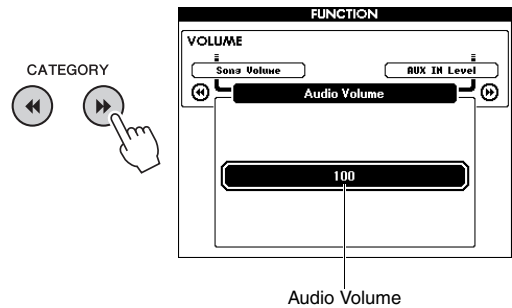

### 3 Rotate the dial to set the Audio volume.

## Changing the Voice of the Song

You can change the Voice of Track 1 or 2 in the current Preset Song temporarily to any other desired Voice.

- 1 Press the [SONG/AUDIO] button, select the desired Preset Song, then start playback.
- 2 Hold down the [VOICE] button for longer than a second to call up the “VOICE SELECT (MELODY R)” display for selecting a Voice.

Pressing the [VOICE] button alternates the display between VOICE SELECT (MELODY R) and VOICE SELECT (MELODY L), then select the desired display. Melody R is the Track 1 Voice, and Melody L is the Track 2 Voice.



Hold for longer than a second.

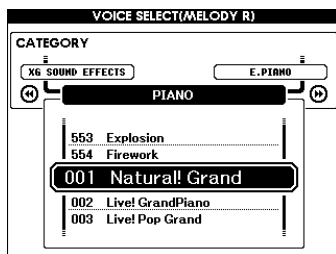

- 3 Rotate the dial to select the desired Voice.

As you select different Voices, the Melody Voice of the Song changes while the Song remains the same.

## Specifying the Channel for the Lesson Part

When using external Songs (only SMF format 0 and 1) in a USB flash drive (or transferred from a computer) for lessons you can specify which channels are to be played back as the right-hand and left-hand parts. The default settings are channel 1 for the right-hand part and channel 2 for the left-hand part.

- 1 Press the [SONG/AUDIO] button and select the Song (106–) for which you want to set the guide track.
- 2 Press the [FUNCTION] button.

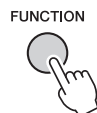

- 3 Use the CATEGORY [◀] and [▶] buttons to select the “Right-Part” or “Left-Part.”
- 4 Use the dial to select the channel you want to play back as the specified right- or left-hand part.

# Connecting a Microphone and Singing Along with Your Performance

By connecting a microphone to the MIC INPUT jack (standard 1/4" phone jack), you can enjoy singing along with your keyboard performance or with Song playback. The instrument outputs your vocals through the built-in speakers. You can enjoy the three preset settings by just selecting one of them according to the particular circumstances and your personal preferences, or you can create your own desired settings and save them.

## Connecting a Microphone

- 1 Before turning on the power of the instrument, set the MIC VOLUME knob to the minimum position.

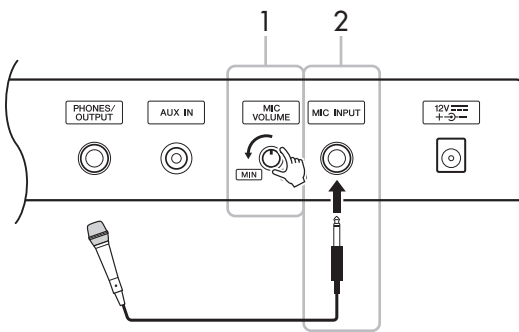

- 2 Connect a microphone to the MIC INPUT jack.

### NOTE

- Make sure to use a conventional dynamic microphone.

- 3 Turn on the power of the instrument.
- 4 Press the [MIC SETTING] button once or twice to call up the MIC SETTING 1 display.



- 5 Select "MIC" by using the CATEGORY [◀] or [▶] button, then set it to "ON" by rotating the dial.

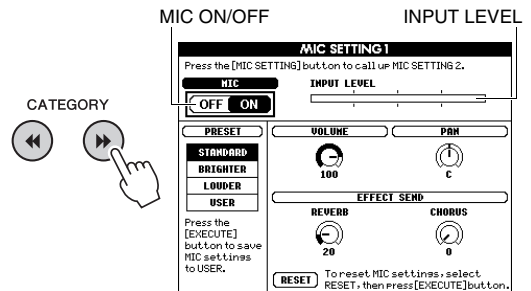

- 6 (If necessary, turn on the microphone.) Adjust the MIC VOLUME knob while singing into the microphone.

Adjust the MIC VOLUME knob so that the INPUT LEVEL meter is not off the scale (or "pinned" continuously to the right). If the INPUT LEVEL meter is off the scale, distortion may be produced.

### Disconnecting the microphone

Set the MIC VOLUME knob to the minimum position then disconnect the microphone from the MIC INPUT jack.

### NOTE

- You can assign the function of switching the MIC ON/OFF to pedals. Refer to "Assigning specific functions to the pedal" (page 21).

## Selecting a Preset Setting

- 1 Press the [MIC SETTING] button once or twice to call up the MIC SETTING 1 display.
- 2 Select "PRESET" by using the CATEGORY [◀] or [▶] button, then select the desired one of "STANDARD", "BRIGHTER" and "LOUDER" by rotating the dial.

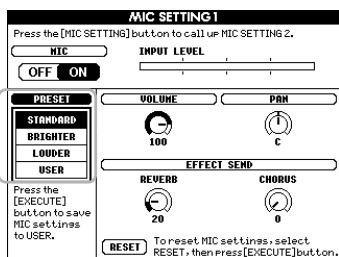

STANDARD	The STANDARD setting provides optimum response over the entire frequency spectrum ensuring all vocals sound good.
BRIGHTER	The BRIGHTER setting emphasizes higher frequencies making vocals stand out more in the mix.
LOUDER	The LOUDER setting compresses the overall signal which increases both the level of your voice and softer sounds.

If you want to make your original settings, set various parameters (including those on MIC SETTING 2) then save the setting as the USER data. For details, see next section.

## Making and Saving the Microphone Settings

This section explains how to make and save the detailed settings for the microphone. Only one group of settings can be saved to USER data.

- 1 Connect a microphone to the instrument, then press the [MIC SETTING] button once or twice to call up the MIC SETTING 1 or 2 display.

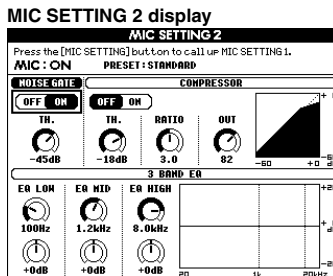
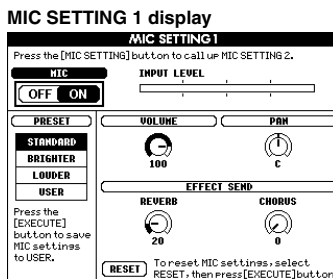

- 2 Use the CATEGORY [◀] or [▶] button to select the specific parameter to be adjusted.  
For information on each parameter, see below.
- 3 Set the value of the specific parameter by rotating the dial.

## MIC SETTING 1 display

MIC ON/OFF*	Turns the microphone sound on or off.	
INPUT LEVEL	Indicates the input level.	
PRESET*	Calls up one of the preset settings (STANDARD, BRIGHTER and LOUDER) or the settings saved as USER.	
VOLUME	Determines the output volume of the microphone sound.	
PAN	Determines the stereo pan position of the microphone sound.	
EFFECT SEND	REVERB	Determines the depth of the reverb effect applied to the microphone sound.
	CHORUS	Determines the depth of the chorus effect applied to the microphone sound.
RESET	Resets the values of parameters on MIC SETTING 1 and 2 displays to the default when one of the preset type is selected. When "USER" is selected, this resets them to the latest saved value.	

\* The settings marked with \* (asterisk) will be maintained even if you turn off the power.

## MIC SETTING 2 display

NOISE GATE	ON/OFF	Turns the Noise Gate on or off. This effect mutes the input signal when the input signal falls below a specified level.
	TH. (Threshold)	Adjusts the input level at which the gate begins to open.
COMPRESSOR	ON/OFF	Turns the Compressor on or off. This effect holds down the output when the input signal from the microphone exceeds a specified level.
	TH. (Threshold)	Adjusts the input level above which the Compressor is applied.
	RATIO	Adjusts the compression ratio. Higher ratios result in a more compressed sound, making soft sounds louder, but reducing the dynamic range.
	OUT	Adjusts the final output level.
3 BAND EQ	EQ (Equalizer) is a processor that divides the frequency spectrum into multiple bands which can be boosted or cut as required to tailor the overall frequency response.	
	Hz	Adjusts the center frequency of the corresponding band.
	dB	Boosts or cuts the level of the corresponding band by up to 12 dB.

### NOTICE

- The settings here are lost if you turn off the power without executing the Save operation (See below).

## 4 Press the [EXECUTE] button to save the settings.

The save confirmation message will appear on the display.



### NOTICE

- The Save operation will delete the previously saved USER data.

### NOTE

- To cancel this operation, press the [-] (NO) button.

## 5 Press the [+] (YES) button to actually save the settings.

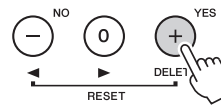

## 6 Press the [EXIT] button to exit from the MIC SETTING display.

## Calling Up the Microphone Settings Saved to USER

1 Press the [MIC SETTING] button once or twice to call up the MIC SETTING 1 display.

2 Select "PRESET" by using the CATEGORY [◀◀] or [▶▶] button, then select "USER" by rotating the dial.

# The Functions

The “Functions” provide access to a range of detailed instrument parameters such as Tuning, Split Point, Voices and Effects. Take a look at the Function List (pages 73–75). When you find the desired Function you want to change, follow the instructions below.

- 1 Find the desired item in the Function List on pages 73–75.
- 2 Press the [FUNCTION] button to call up the FUNCTION display.

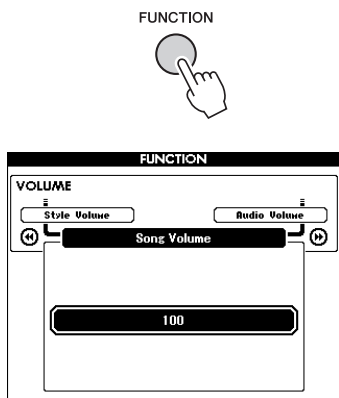

- 3 Press the CATEGORY [◀◀] or [▶▶] buttons several times until the desired item appears.

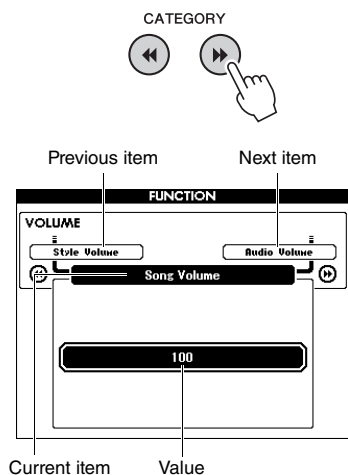

- 4 Use the dial, the [+] and [-] buttons, or the [0]–[9] number buttons to set the value of the selected function.

To restore the default value, press the [+] and [-] buttons simultaneously. In the sole case of the MIDI Initial Send function, pressing the [+] button executes the function while pressing [-] cancels it.

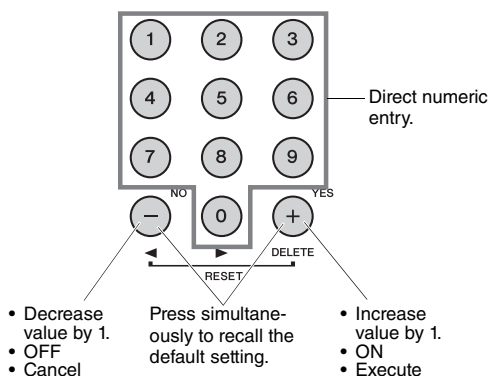

Some Function settings are maintained even if you turn off the power, and can be transferred to the computer as Backup Data (page 52).



Function List

Category	Function	Range/Settings	Default Value	Description
Volume	Style Volume	000–127	100	Refer to page 63.
	Song Volume	000–127	100	Refer to page 67.
	Audio Volume	000–127	100	Determines the volume of the Audio file.
	Wireless LAN Volume	000–127	100	Determines the volume of the Wireless LAN Audio.
	AUX IN Level	000–127	100	Determines the volume of the sound input via the AUX IN jack.
Overall	Transpose	-12–+12	00	Refer to page 55.
	Tuning	415.3Hz–466.2Hz	440.0Hz	Refer to page 56.
	Pitch Bend Range	01–12	02	Sets the range over which you can control pitch by using the PITCH BEND wheel (page 56), in semitone increments.
	Split Point	021 (A-1)–108 (C7)	054 (F#2)	Refer to page 64.
	Touch Response	1 (Soft)/ 2 (Medium)/ 3 (Hard)/ 4 (Fixed)	2 (Medium)	Refer to page 57.
Chord Fingering	1 (Multi Finger)/ 2 (FullKeyboard)/ 3 (All Fingered)	1 (Multi Finger)	Refer to page 64.	
Main Voice (page 27)	Main Volume	000–127	*	Determines the volume of the Main Voice.
	Main Octave	-2–+2	*	Determines the octave range for the Main voice.
	Main Pan	000 (left)– 64 (center)– 127 (right)	*	Determines the stereo pan position of the Main Voice. A value of "0" results in the sound being panned full left; a value of "127" results in the sound being panned full right.
	Main Reverb Level	000–127	*	Determines how much of the Main Voice's signal is sent to the Reverb effect.
	Main Chorus Level	000–127	*	Determines how much of the Main Voice's signal is sent to the Chorus effect.
	Main DSP Level	000–127	*	Determines how much of the Main voice's signal is sent to the DSP effect.
Dual Voice (pages 28, 60)	Dual Volume	000–127	*	Determines the volume of the Dual Voice.
	Dual Octave	-2–+2	*	Determines the octave range for the Dual voice.
	Dual Pan	000 (left)– 64 (center)– 127 (right)	*	Determines the stereo pan position of the Dual Voice. A value of "0" results in the sound being panned full left; a value of "127" results in the sound being panned full right.
	Dual Reverb Level	000–127	*	Determines how much of the Dual Voice's signal is sent to the Reverb effect.
	Dual Chorus Level	000–127	*	Determines how much of the Dual Voice's signal is sent to the Chorus effect.
	Dual DSP Level	000–127	*	Determines how much of the Dual Voice's signal is sent to the DSP effect.
Split Voice (pages 28, 60)	Split Volume	000–127	080	Determines the volume of the Split Voice.
	Split Octave	-2–+2	0	Determines the octave range for the Split voice.
	Split Pan	000 (left)– 64 (center)– 127 (right)	064	Determines the stereo pan position of the Split Voice. A value of "0" results in the sound being panned full left; a value of "127" results in the sound being panned full right.
	Split Reverb Level	000–127	008	Determines how much of the Split Voice's signal is sent to the Reverb effect.
	Split Chorus Level	000–127	000	Determines how much of the Split Voice's signal is sent to the Chorus effect.

Category	Function	Range/Settings	Default Value	Description
Effect	Reverb Type	01–42	**	Refer to page 53.
	Chorus Type	01–45	**	Refer to page 53.
	DSP	ON/OFF	*	Refer to page 54.
	DSP Type	001–239	*	Refer to page 54.
	Damper Resonance	ON/OFF	ON	Refer to page 21.
	Sustain	ON/OFF	OFF	Refer to page 55.
	MASTER EQ Type	1 (Normal)/ 2 (Piano)/ 3 (Soft)/ 4 (Bright)/ 5 (Powerful)	1 (Normal)	Refer to page 57.
	Output Gain	Headphones/ Line Out/ Fixed	Headphones	Refer to page 58.
	I. A. Control	ON/OFF	ON	Refer to page 59.
	I. A. Control Depth	-3–+3	0	Refer to page 59.
Harmony (page 31)	Harmony Type	01–26	*	Determines the Harmony type.
	Harmony Volume	000–127	*	Determines the volume of the Harmony effect.
Pedal	Assignable Pedal	SUSTAIN, PORTAMENTO, MIC ON/OFF, START/STOP, TAP TEMPO	SUSTAIN	Refer to page 21.
	Portamento Time	000–127	064	Determines the pitch transition time (page 21). Higher values result in a longer pitch change time. Setting this to “0” results in no effect.
PC (USB TO HOST terminal)	PC Mode	PC1/PC2/OFF	OFF	Optimizes the MIDI settings when transmitting or receiving the performance data between the computer and the instrument (page 75).
MIDI***	Local	ON/OFF	ON	Determines whether the instrument’s keyboard controls the internal tone generator (ON) or not (OFF). When you record your keyboard performance to the application software on the computer via MIDI, set this parameter to OFF.
	External Clock	ON/OFF	OFF	Determines whether the instrument synchronizes to the internal clock (OFF) or an external clock (ON). When you record your keyboard performance to the application software on the computer via MIDI, set this parameter to ON.
	Keyboard Out	ON/OFF	ON	Determines whether MIDI messages generated via keyboard performance are transmitted (ON) or not (OFF) from the USB TO HOST terminal.
	Style Out	ON/OFF	OFF	Determines whether MIDI messages generated via Style playback are transmitted (ON) or not (OFF) from the USB TO HOST terminal.
	Song Out	ON/OFF	OFF	Determines whether MIDI messages generated via Song playback are transmitted (ON) or not (OFF) from the USB TO HOST terminal.
	Initial Setup	ON	–	Lets you send the data of the panel settings to a computer. Press [+] to send, or press [-] to cancel during sending. This operation should be done immediately after starting the Recording operation on the computer.

Category	Function	Range/Settings	Default Value	Description
Metronome (page 29)	Time Signature - Numerator	1–60	**	Determines the time signature of the Metronome.
	Time Signature - Denominator	2/4/8/16	**	Determines the length of each metronome beat.
	Bell	ON/OFF	ON	Determines whether a bell accent will be sounded (ON) or not (OFF).
	Metronome Volume	000–127	100	Determines the volume of the Metronome.
Score	Quantize	1 (1/4 note)/ 2 (1/4 note triplet)/ 3 (1/8 note)/ 4 (1/8 note triplet)/ 5 (1/16 note)/ 6 (1/16 note triplet)/ 7 (1/32 note)/ 8 (1/32 note triplet)	–	Depending on the Song data, you can make the score more readable by adjusting the timing of the notes. This determines the minimum timing resolution used in the Song. For example, if there are both quarter notes and eighth notes in the Song, you should set this value to “eighth note.” Any notes or rests shorter than this value will not be shown in the score.
Song/Lesson	Right-Part	CH 01, 02...15, 16, OFF	CH 01	Determines the guide track number for your right hand lesson. The setting is effective for Songs in SMF format 0 and 1 that are transferred from an external device.
	Left-Part	CH 01, 02...15, 16, OFF	CH 02	Determines the guide track number for your left hand lesson. The setting is effective for Songs in SMF format 0 and 1 that are transferred from an external device.
Lesson	Grade	ON/OFF	ON	Determines whether the Grade function is on or off.
Demo	Demo Group	1 (Demo)/ 2 (Preset)/ 3 (User)/ 4 (Download)/ 5 (USB)	1 (Demo)	Refer to page 66.
	Demo Play Mode	1 (Normal)/ 2 (Random)	1 (Normal)	Refer to page 66.
	Demo Cancel	ON/OFF	OFF	Determines whether Demo cancel is enabled or not. When this is set to ON, the Demo Song will not play, even if the [DEMO/BGM] button is pressed.
Utility	Speaker Control	NORMAL/ ALWAYS ON	NORMAL	Refer to page 58.
	Auto Power Off	OFF/5/10/15/30/60/ 120 (min.)	30	Refer to page 19.

\* The appropriate value is automatically set for each Voice combination.

\*\* The appropriate value is automatically set for each Song or Style.

\*\*\* For details, refer to “Computer-related Operations” (page 8).

### PC Mode

The PC settings instantly reconfigure all important MIDI settings (as shown below). This setting is not necessary when transferring files between the computer and the instrument via Musicsoft Downloader.

	PC1	PC2	OFF
Local	OFF	OFF	ON
External Clock	ON	OFF	OFF
Song Out	OFF	OFF	OFF
Style Out	OFF	OFF	OFF
Keyboard Out	OFF	ON	ON

**[NOTE]**

- Preset Song data cannot be transmitted from the instrument by the Song Out function, but User Songs can.

# Connections – Using Your Instrument with Other Devices –

To see where the connectors are located on the instrument, refer to pages 16, 17.

## CAUTION

- Before connecting the instrument to other electronic components, turn off the power of all the components. Also, before turning any components on or off, make sure to set all volume levels to minimum (0). Otherwise, damage to the components, electrical shock, or even permanent hearing loss may occur.

## Connecting an Audio Device (AUX IN jack)

You can connect the output jack of an external device such as portable audio player to the instrument's AUX IN jack, letting you hear the sound of that device through the built-in speakers of the instrument.

## NOTICE

- To avoid damaging the device, first turn on the power to the external device, then to the instrument. When turning off the power, first turn off the power to the instrument, then to the external device.

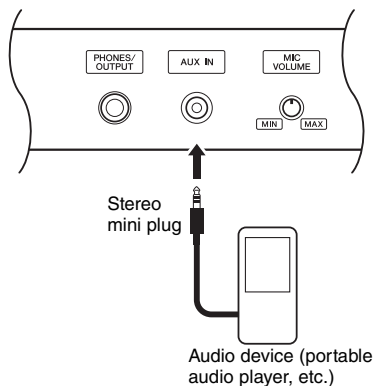

## NOTE

- Use audio cables and adaptor plugs having no (zero) resistance.
- You can adjust the volume of the sound input via the AUX IN jack from the external audio device. To do this, press the [FUNCTION] button then use the CATEGORY buttons to select "AUX IN Level," then adjust the value by using the dial.

## Connecting to a Computer (USB TO HOST terminal)

By connecting a computer to the USB TO HOST terminal, you can transfer data between the instrument and the computer via MIDI. For details on using a computer with this instrument, refer to "Computer-related Operations" on the website (page 8).

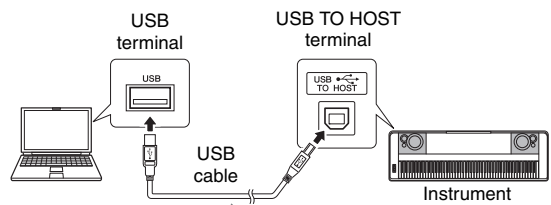

## NOTICE

- Use an AB type USB cable of less than 3 meters. USB 3.0 cables cannot be used.

## NOTE

- The instrument will begin transmission a short time after the USB connection is made.
- When using a USB cable to connect the instrument to your computer, make the connection directly without passing through a USB hub.
- For information on setting up your sequence software, refer to the owner's manual of the relevant software.

## Connecting to an iPhone/iPad (USB TO DEVICE, USB TO HOST terminals)

By connecting this instrument to a smart device, such as an iPhone or iPad, you can use apps on that device together with the instrument for a variety of musical purposes, take advantage of various convenient functions, and get more enjoyment out of this instrument. Make connections by using one of the following methods.

### NOTE

- Before using the USB TO DEVICE terminal, be sure to read “Precautions when using the USB TO DEVICE terminal” on page 80.

- Connect to the USB TO DEVICE terminal via the USB wireless LAN adaptor UD-WL01 (sold separately; may not be available in some areas).
- Connect to the USB TO HOST terminal via the USB cable for iPhone/iPad.

For details on connections, refer to the “iPhone/iPad Connection Manual” on the website (page 8) and the “Wireless LAN Settings” (See next section).

For information about the compatible smart devices and application tools, access the following page:

<http://www.yamaha.com/kbdapps/>

### NOTICE

- Do not place your iPhone/iPad in an unstable position. Doing so may cause the device to fall and result in damage.

### NOTE

- When you use the instrument along with an application on your iPhone/iPad, we recommend that you first set “Airplane Mode” to “ON” then set “Wi-Fi” to “ON” on your iPhone/iPad in order to avoid noise caused by communication.
- Certain applications may not be supported in your area. Please check with your Yamaha dealer.

## Wireless LAN Settings

By using the USB wireless LAN adaptor UD-WL01 (sold separately), you can connect the instrument to an iPhone/iPad via a wireless network. For general operating instructions, refer to the “iPhone/iPad Connection Manual” on the website (page 8). This section covers operations that are specific to this instrument.

### Choosing the Connection Type

You can use one of connection modes: Infrastructure or Access Point. Select one which is most suitable for your network environment.

**Infrastructure mode:** The “Infrastructure” mode uses an access point for data communication, between the USB wireless LAN adaptor UD-WL01 and a network.

**Access Point mode:** The “Access Point” mode allows you to directly connect the USB wireless LAN adaptor UD-WL01 and your iPhone/iPad, without using an access point. Please note that when your instrument is set to Access Point mode, no Internet access is available on your iPhone/iPad, limiting part of their functions, such as mailing and searching.

- 1 Turn off the power to the instrument.
- 2 Connect the USB wireless LAN adaptor UD-WL01 to the USB TO DEVICE terminal of the instrument.
- 3 Turn on the power to the instrument.
- 4 Press the [FILE CONTROL] button to call up the FILE CONTROL display.

FILE CONTROL



5 Use the CATEGORY [◀◀] or [▶▶] button to select “Wireless LAN.”

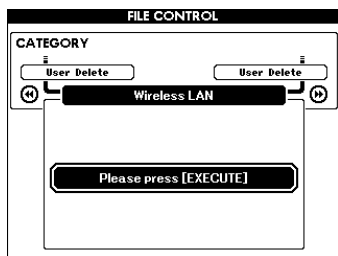

**NOTE**

- When “Wireless LAN” cannot be found even though the USB wireless LAN adaptor has been connected, turn the instrument off then on again.

6 Press the [EXECUTE] button to call up the WIRELESS LAN display. “WIRELESS LAN - Infrastructure Mode” is the default setting.

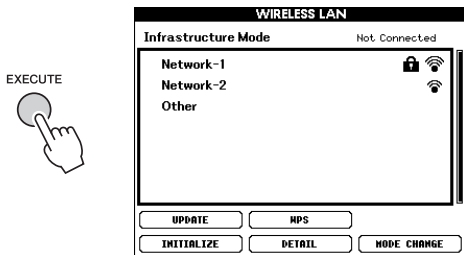

7 Use the CATEGORY [◀◀] or [▶▶] button to select the desired operation, then press the [EXECUTE] button.

This operation lets you change the connection mode. For information on the WIRELESS LAN displays, see the next section.

**NOTE**

- For information on entering characters for the password or settings, refer to page 83.

**Infrastructure Mode**

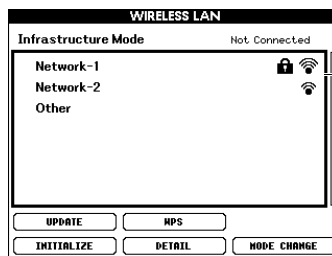

Network list

Network list	<p>Select your personal network from this list to connect automatically, or input the desired one manually. Use the CATEGORY [◀◀] or [▶▶] button to select this area, and then follow the instructions below.</p> <p><b>Connecting to a network by selecting from the list</b></p> <ol style="list-style-type: none"> <li>1. Select the desired network by rotating the dial.</li> <li>2. Press the [EXECUTE] button. For a network without a lock icon, this finishes connecting to the network. For a network having a lock icon (🔒), the PASSWORD display appears.</li> <li>3. Enter the password on the PASSWORD display by rotating the dial.</li> <li>4. Select “Connect” by using the CATEGORY [◀◀] or [▶▶] button, then press the [EXECUTE] button.</li> </ol> <p><b>Connecting to a network manually</b></p> <ol style="list-style-type: none"> <li>1. Select “Other” displayed at the very end of the list by rotating the dial.</li> <li>2. Press the [EXECUTE] button to call up the OTHER NETWORK display.</li> <li>3. Make SSID, security, and password settings by rotating the dial.</li> <li>4. Select “Connect” by using the CATEGORY [◀◀] or [▶▶] button, then press the [EXECUTE] button.</li> </ol>
UPDATE	Updates the network list on the display.
WPS	<p>Connects this instrument to the network via WPS.</p> <p><b>NOTE</b></p> <ul style="list-style-type: none"> <li>• Make sure that your access point supports WPS. About the confirmation and changes in the access point settings, refer to the manual of the access point.</li> </ul> <ol style="list-style-type: none"> <li>1. Select “WPS” by using the CATEGORY [◀◀] or [▶▶] button, then press the [EXECUTE] button.</li> <li>2. Press the WPS button on your access point within two minutes.</li> </ol>
INITIALIZE	Initializes the connection setup to the default factory status.

DETAIL	<p>Set detailed parameters from the pages below.</p> <p>Page 1/2: For setting the IP address and other related parameters.</p> <p>Page 2/2: For entering the Host name or showing MAC address, etc.</p> <p>Use the CATEGORY [◀◀] or [▶▶] button to select the parameters, and then use the dial to set the value. After making the settings, select "SAVE" on page 2/2 by using the CATEGORY [◀◀] or [▶▶] button, and press the [EXECUTE] button to actually save them.</p>
MODE CHANGE	Switches to the Access Point mode.

### Access Point Mode

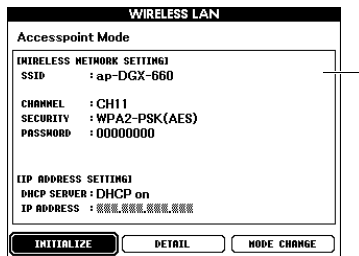

Displaying the wireless network settings.

INITIALIZE	Initializes the connection setup to the default factory status.
DETAIL	<p>Set detailed parameters from the pages below.</p> <p>Page 1/2: For setting the SSID, channel, security, password, IP address and other related parameters.</p> <p>Page 2/2: For entering the Host name or showing MAC address, etc.</p> <p>Use the CATEGORY [◀◀] or [▶▶] button to select the parameters, and then use the dial to set the value. After making the settings, select "SAVE" on page 2/2 by using the CATEGORY [◀◀] or [▶▶] button and press the [EXECUTE] button to actually save them.</p>
MODE CHANGE	Switches to the Infrastructure mode.

For information on making settings for/on your iPhone/iPad, refer to the "iPhone/iPad Connection Manual" on the website (page 8).

# USB Flash Drive Operations

By connecting the USB flash drive to the USB TO DEVICE terminal, you can save the data created on this instrument, such as User Song and parameter settings. The saved data can be recalled to this instrument again for future use.

## Precautions when using the USB TO DEVICE terminal

This instrument features a built-in USB TO DEVICE terminal. When connecting a USB device to the terminal, be sure to handle the USB device with care. Follow the important precautions below.

### NOTE

- For more information about the handling of USB devices, refer to the owner's manual of the USB device.

## Compatible USB devices

- USB flash drive
- USB wireless LAN adaptor (UD-WL01) (may not be available depending on your area)

Other USB devices such as a USB hub, computer keyboard or mouse cannot be used.

The instrument does not necessarily support all commercially available USB devices. Yamaha cannot guarantee operation of USB devices that you purchase. Before purchasing a USB device for use with this instrument, please visit the following web page:

<http://download.yamaha.com/>

Although USB devices 1.1 to 3.0 can be used on this instrument, the amount of time for saving to or loading from the USB device may differ depending on the type of data or the status of the instrument.

### NOTE

- The rating of the USB TO DEVICE terminal is a maximum of 5V/500mA. Do not connect USB devices having a rating above this, since this can cause damage to the instrument itself.

## Connecting USB device

When connecting a USB device to the USB TO DEVICE terminal, make sure that the connector on the device is appropriate and that it is connected in the proper direction.

## NOTICE

- Avoid connecting or disconnecting the USB device during playback/recording and file management operations (such as Save, Delete and Format), or when accessing the USB device. Failure to observe this may result in "freezing" of the operation of the instrument or corruption of the USB device and the data.
- When connecting then disconnecting the USB device (and vice versa), make sure to wait a few seconds between the two operations.

### NOTE

- When connecting a USB cable, make sure that the length is less than 3 meters.

## Using a USB flash drive

By connecting the instrument to a USB flash drive, you can save data you've created to the connected device, as well as read data from the connected USB flash drive.

## Maximum number of USB flash drive allowed

Only one USB flash drive can be connected to the USB TO DEVICE terminal.

## Formatting USB flash drive

You should format the USB flash drive only with this instrument (page 82). A USB flash drive formatted on another device may not operate properly.

## NOTICE

- The format operation overwrites any previously existing data. Make sure that the USB flash drive you are formatting does not contain important data.

## To protect your data (write-protect)

To prevent important data from being inadvertently erased, apply the write-protect provided with each USB flash drive. If you are saving data to the USB flash drive, make sure to disable write-protect.

## Turning off the instrument

When turning off the instrument, make sure that the instrument is NOT accessing the USB flash drive by playback/recording or file management (such as during Save, Delete and Format operations). Failure to do so may corrupt the USB flash drive and the data.



## Connecting a USB Flash Drive

- 1 **Connect a USB flash drive to the USB TO DEVICE terminal, being careful to insert it with the proper orientation.**

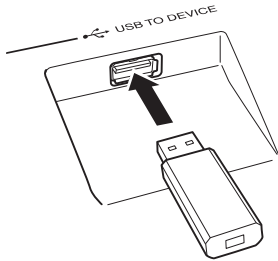

A message (information or confirmation dialog) sometimes appears on the display to facilitate operation. Refer to the “Messages” on page 89 for an explanation of each message.

- 2 **Wait for confirmation that the USB flash drive has been properly mounted.**

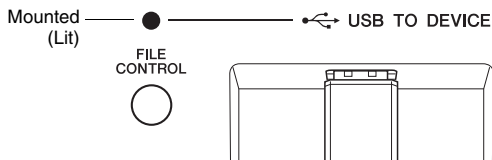
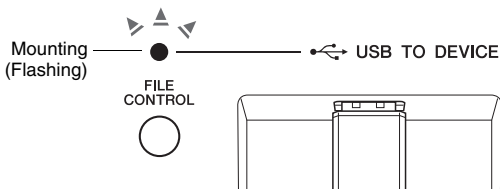

### Calling up the FILE CONTROL display

Pressing the [FILE CONTROL] button while the USB flash drive is connected to the USB TO DEVICE terminal calls up the FILE CONTROL display.

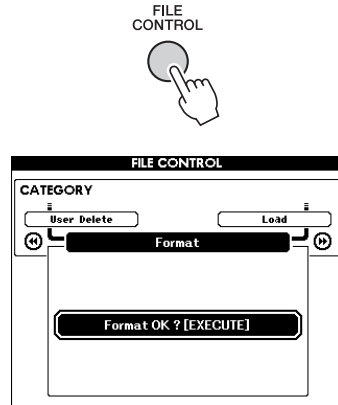

You can access file operations listed below by pressing the CATEGORY [◀◀] or [▶▶] buttons from the FILE CONTROL display.

Menu	Reference page
Format	82
Regist Save	83
User Song Save	84
Audio Save	85
Load	86
USB Delete	87
User Delete	87

If you press the [FILE CONTROL] button while an unformatted USB flash drive is connected to the instrument, the “Format” function will automatically be selected.

To exit from the FILE CONTROL display press the [EXIT] button.

**NOTE**

- No sound will be produced if you play the keyboard while the FILE CONTROL display is showing. Also, in this state only buttons related to file functions will be active.

**NOTE**

- The FILE CONTROL display will not appear in any of the following cases:
  - During Style, Song or Audio playback.
  - During Lesson and Style Recommender.
  - While data is being loaded from a USB flash drive.

## Formatting a USB Flash Drive

The Format operation lets you prepare commercially available USB flash drive for use with this instrument.

**NOTICE**

- If a USB flash drive that contains data is formatted as described below, the data will be erased. Make sure that a USB flash drive to be formatted contains no important data before carrying out the formatting procedure.

1 Press the [FILE CONTROL] button to call up the FILE CONTROL display.



2 Use the CATEGORY [◀] or [▶] buttons to call up “Format.”

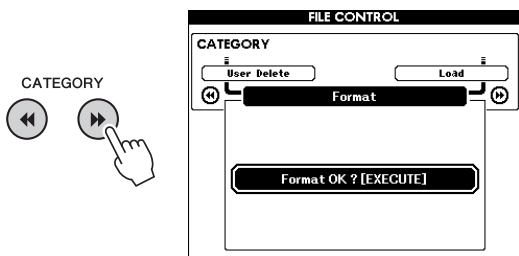

3 Press the [EXECUTE] button.  
A confirmation message will appear. To cancel the operation, press the [-] (NO) button.



4 Press the [EXECUTE] button again or the [+] (YES) button to execute the Format operation.

After a while, a message indicating completion of the operation appears, and the “USER FILES” folder will be created on the root directory in the USB flash drive.

**NOTICE**

- The Format operation cannot be cancelled during execution. Never turn off the power or disconnect the USB flash drive during the operation. Doing so may result in data loss.

5 Press the [EXIT] button to exit from the FILE CONTROL display.

## Saving a Registration Memory to USB Flash Drive

This operation saves a Registration Memory to a USB flash drive device. The file name will have a “.usr” extension which does not appear in the instrument’s display.

- 1 Press the [FILE CONTROL] button to call up the FILE CONTROL display.



- 2 Use the CATEGORY [◀] or [▶] buttons to call up “Regist Save.”

A default file name will automatically be created.

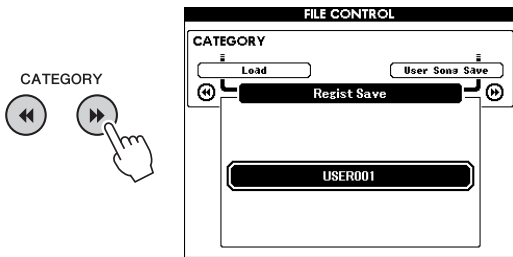

### To Overwrite an Existing File

If you want to overwrite a file that already exists on the USB flash drive, use the dial or the [+] and [-] buttons to select the file, then skip ahead to step 5.

**NOTE**

- Up to 100 User files can be saved to a single USB flash drive.

- 3 Press the [EXECUTE] button.

A cursor will appear below the first character in the file name.

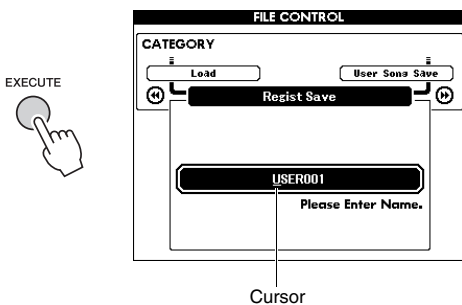

- 4 Change the file name as necessary.

### Entering Characters

The [-] button moves the cursor to the left, and the [0] button moves it to the right. Use the dial to select a character for the current cursor location. The [+] button deletes the character at the cursor location.

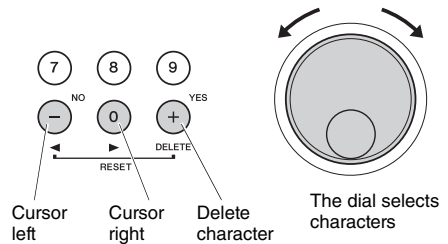

- 5 Press the [EXECUTE] button.

A confirmation message will appear. To cancel the operation, press the [-] (NO) button.

- 6 Press the [EXECUTE] button again, or the [+] (YES) button to execute the Save operation.

After a while, a message indicating completion of the operation appears. Registration Memory will be saved in a folder labeled “USER FILES” which will automatically be created on the USB flash drive.

**NOTICE**

- If an existing file name is specified, the display prompts you for confirmation. Press [EXECUTE] or [+] if it is OK to overwrite the file, or [-] to cancel.

**NOTICE**

- The Save operation cannot be cancelled during execution. Never turn off the power or disconnect the USB flash drive during the operation. Doing so may result in data loss.

- 7 Press the [EXIT] button to exit from the FILE CONTROL display.

**NOTE**

- If you want to recall the Registration Memory (.usr) to this instrument again, execute the Load operation (page 86).

**NOTE**

- The amount of time it will take to perform the Save operation will depend on the condition of the USB flash drive.

## Saving a User Song to USB Flash Drive

This operation saves a User Song (Song numbers 101–105) to USB flash drive.

- 1 Press the [FILE CONTROL] button to call up the FILE CONTROL display.



- 2 Use the CATEGORY [◀] or [▶] buttons to call up “User Song Save.”

The SOURCE FILE—a User Song name—will be highlighted.

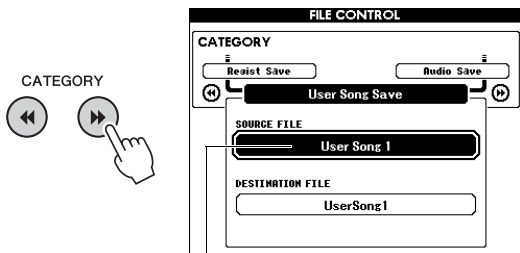

The source User Song name.

- 3 Use the dial to select the User Song you want to save.

- 4 Press the [EXECUTE] button.

The DESTINATION FILE parameter will be highlighted, and a default name will automatically be created.



### To Overwrite an Existing File

If you want to overwrite a file that already exists on the USB flash drive, use the dial to select the file, then skip ahead to step 7.

- 5 Press the [EXECUTE] button.

A cursor will appear below the first character in the file name.

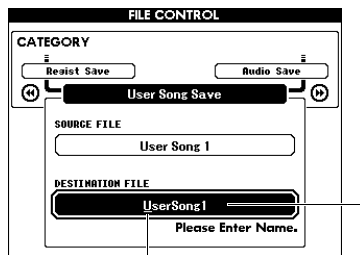

Cursor

The name of the file to be saved

- 6 Change the file name as necessary.

Refer to “Saving a Registration Memory to USB Flash Drive” on page 83 for filename entry.

- 7 Press the [EXECUTE] button.

A confirmation message will appear. To cancel the operation, press the [-] (NO) button.

- 8 Press the [EXECUTE] button again, or the [+] (YES) button to execute the Save operation.

After a while, a message indicating completion of the operation appears.

The User Song will be saved in a folder labeled “USER FILES” which will automatically be created on the USB flash drive.

### NOTICE

- If an existing file name is specified, the display prompts you for confirmation. Press [EXECUTE] or [+] if it is OK to overwrite the file, or [-] to cancel.

### NOTICE

- The Save operation cannot be cancelled during execution. Never turn off the power or disconnect the USB flash drive during the operation. Doing so may result in data loss.

- 9 Press the [EXIT] button to exit from the FILE CONTROL display.

### NOTE

- The amount of time it will take to perform the Save operation will depend on the condition of the USB flash drive.

## Converting a User Song to an Audio file

This operation converts a User Song (Song numbers 101–105) to an Audio file and saves the file to the USB flash drive.

**NOTE**

- Only User Songs can be converted to Audio files.

**1 Press the [FILE CONTROL] button to call up the FILE CONTROL display.**



**2 Use the CATEGORY [◀] or [▶] buttons to call up “Audio Save.”**

The SOURCE FILE—a User Song name—will be highlighted.

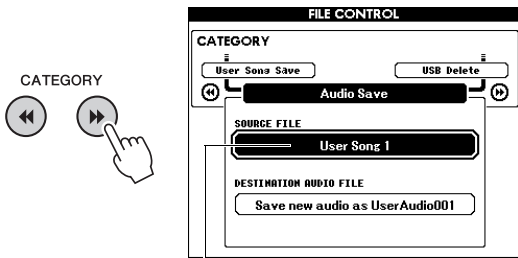

The source User Song name.

**3 Use the dial to select the User Song you want to convert.**

**4 Press the [EXECUTE] button.**

The DESTINATION AUDIO FILE parameter will be highlighted, and a default name will automatically be created.



**To Overwrite an Existing File**

If you want to overwrite a file that already exists on the USB flash drive, use the dial to select the file, then go on to the next step.

**5 Press the [EXECUTE] button.**

A confirmation message will appear. To cancel the operation, press the [-] (NO) button.

**6 Press the [EXECUTE] button again, or the [+] (YES) button to execute the Save (Convert) operation.**

This operation starts playback and conversion from a User Song to an audio file. If you input audio signals via the AUX IN jack during conversion, that sound also will be recorded.

After a while, a message indicating completion of the operation appears.

The Audio file will be saved in a folder labeled “USER FILES” which will automatically be created on the USB flash drive.

**NOTICE**

- If an existing file name is specified, the display prompts you for confirmation. Press [EXECUTE] or [+] if it is OK to overwrite the file, or [-] to cancel.

**NOTICE**

- Never turn off the power or disconnect the USB flash drive during the operation. Doing so may result in data loss.

**7 Press the [EXIT] button to exit from the FILE CONTROL display.**

**NOTE**

- The amount of time it takes to perform the Save operation depends on the condition of the USB flash drive.

## Loading Files from a USB Flash Drive

Registration Memory, Style file and Song file (SMF) residing on a USB flash drive can be loaded into the instrument.

**NOTICE**

- If you load a Registration Memory, data will be overwritten by the newly loaded data. Save important data to a USB flash drive before loading data that will overwrite it.

1 Press the [FILE CONTROL] button to call up the FILE CONTROL display.



2 Use the CATEGORY [◀◀] or [▶▶] buttons to call up “Load.”

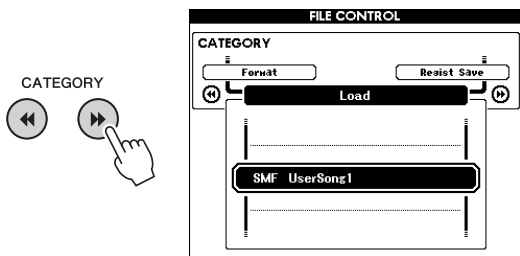

3 Use the dial to select the file you want to load.

All Registration Memory files in the USB flash drive will be displayed first, followed by the Style files and Song files.

Files must be located in the “USER FILES” folder in the USB flash drive. Files located outside of that folder will not be recognized.

4 Press the [EXECUTE] button.

A confirmation message will appear. To cancel the operation, press the [-] (NO) button.



5 Press the [EXECUTE] button again, or the [+] (YES) button to execute the Load operation.

After a while, a message indicating completion of the operation appears.

**NOTICE**

- The Load operation cannot be cancelled during execution. Never turn off the power or disconnect the USB flash drive during the operation. Doing so may result in data loss.

6 Press the [EXIT] button to exit from the FILE CONTROL display.

## Deleting files from a USB Flash Drive

This procedure deletes Registration Memory, Style file, Song file and Audio file from a USB flash drive.

- 1 Press the [FILE CONTROL] button to call up the FILE CONTROL display.
- 2 Use the CATEGORY [◀] or [▶] buttons to call up “USB Delete.”

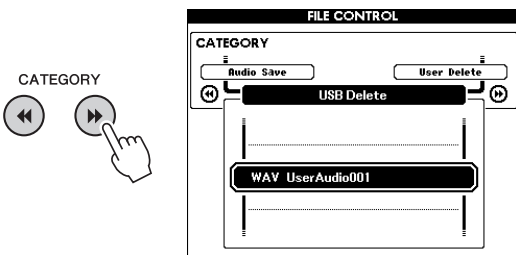

- 3 Use the dial to select the file you want to delete.

All Registration Memory files in the USB flash drive will be displayed first, followed by the Song files, Audio files and Style files.

Files must be located in the “User Files” folder in the USB flash drive. Files located outside of that folder will not be recognized.

- 4 Press the [EXECUTE] button. A confirmation message will appear. To cancel the operation, press the [-] (NO) button.

- 5 Press the [EXECUTE] button again, or the [+] (YES) button to execute the Delete operation.

After a while, a message indicating completion of the operation appears.

**NOTICE**

- The Delete operation cannot be cancelled during execution. Never turn off the power or disconnect the USB flash drive during the operation. Doing so may result in data loss.

- 6 Press the [EXIT] button to exit from the FILE CONTROL display.

## Deleting User Data from the Instrument

This procedure deletes User Song files as well as Style and Song files loaded or transferred from an external device such as a computer. This operation does not erase the Preset data.

- 1 Press the [FILE CONTROL] button to call up the FILE CONTROL display.
- 2 Use the CATEGORY [◀] or [▶] buttons to call up “User Delete.”

Only “User Delete” can be selected if no USB flash drive is connected to the instrument.

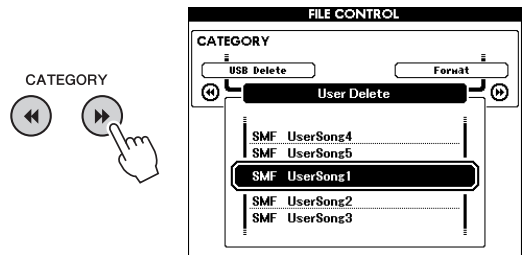

- 3 Use the dial to select the file you want to delete.

All User Songs will be displayed first, followed by the Song and Style files.

- 4 Press the [EXECUTE] button. A confirmation message will appear. To cancel the operation, press the [-] (NO) button.

- 5 Press the [EXECUTE] button again, or the [+] (YES) button to execute the Delete operation.

After a while, a message indicating completion of the operation appears.

**NOTICE**

- The Delete operation cannot be cancelled during execution. Never turn off the power or disconnect the USB flash drive during the operation. Doing so may result in data loss.

- 6 Press the [EXIT] button to exit from the FILE CONTROL display.

# Troubleshooting

## For the Instrument

Problem	Possible Cause and Solution
When the instrument is turned on or off, a popping sound is temporarily produced.	This is normal and indicates that the instrument is receiving electrical power.
The power is automatically turned off.	This is normal and due to the Auto Power Off function. If necessary, set the parameter of the Auto Power Off function (page 19).
When using a mobile phone, noise is produced.	Using a mobile phone in close proximity to the instrument may produce interference. To prevent this, turn off the mobile phone or use it further away from the instrument.
Noise is heard from the instrument's speakers or headphones when using the instrument with an iPhone/iPad application.	When you use the instrument along with an iPhone/iPad application, we recommend that you set "Airplane Mode" to "ON" on your iPhone/iPad in order to avoid noise caused by communication.
There is no sound even when the keyboard is played or when a Style or Song is being played back.	Check that nothing is connected to the PHONES/OUTPUT jack on the rear panel. When a plug is connected to this jack, no sound is output.
	Check the Local Control on/off setting ("Local"). (See page 74.)
	Is the FILE CONTROL display showing? The instrument's keyboard, etc., will not produce any sound while the FILE CONTROL display is showing. Press the [EXIT] button to return to the MAIN display.
Playing keys in the right hand area of the keyboard does not produce any sound.	When using the Dictionary function (page 65), the keys in the right hand area are used only for entering the chord root and type.
The Style or Song does not play back when the [START/STOP] button is pressed.	Is External Clock set to ON? Make sure External Clock is set to OFF; refer to "External Clock" on page 74.
The Style does not sound properly.	Make sure that the Style Volume (page 63) is set to an appropriate level.
	Is the Split Point set at an appropriate key for the chords you are playing? Set the Split Point at an appropriate key (page 64).
	Is the "ACMP" indicator showing in the display? If it is not showing press the [ACMP ON/OFF] button so that it does show.
No rhythm accompaniment plays when the [START/STOP] button is pressed after selecting style number 174 or a style between 188–205 (Pianist).	This is not a malfunction. Style number 174 and style numbers 188–205 (Pianist) have no rhythm parts, so no rhythm will play. The other parts will begin playing when you play a chord in the accompaniment range of the keyboard if the ACMP is turned on.
Not all simultaneously played notes sound.	You are probably exceeding the maximum polyphony (page 90) of the instrument. When the maximum polyphony is exceeded, the earliest played notes will stop sounding, letting the latest played notes sound.
The footswitch (for sustain) seems to produce the opposite effect. For example, pressing the footswitch cuts off the sound and releasing it sustains the sounds.	The polarity of the footswitch is reversed. Make sure that the footswitch plug is properly connected to the SUSTAIN jack before turning on the power.
The sound of the Voice changes from note to note.	This is normal. The AWM tone generation method uses multiple recordings (samples) of an instrument across the range of the keyboard; thus, the actual sound of the Voice may be slightly different from note to note.
The appropriate display does not appear when the [SONG/AUDIO], [STYLE], or [VOICE] button is pressed.	Is another display showing? Try pressing the [EXIT] button to return to the MAIN display, and then pressing one of the mentioned buttons.
The ACMP indicator does not appear when the [ACMP ON/OFF] button is pressed.	Always press the [STYLE] button first when you are going to use any Style-related function.
The "Over Current" message is shown in the upper left area of the MAIN display and the USB device does not respond.	Communication with the USB device has been shut down because of the overcurrent to the USB device. Disconnect the device from the USB TO DEVICE terminal, then turn on the power of the instrument.
The Headphone sound is too low.	Make sure the parameter of "Output Gain" is set to "Headphones" (page 58).



# Messages

LCD Message	Comment
Access error!	Indicates the failure in reading or writing from/to the media or the flash memory.
Clearing all memory...	Displayed while erasing all data in the flash memory. Never turn the power off during data transmission.
Data Error!	Displayed when the Song or Style contains illegal data.
File information area is not large enough.	Indicates that saving data in the media cannot be executed since the total number of files have become too many.
File is not found.	Indicates there is no file.
File too large. Loading is impossible.	Indicates that loading data cannot be executed since the file data is too large.
Media capacity is full.	Displayed when saving data cannot be executed since the media memory has become full.
Memory Full	Displayed when the internal memory becomes full during Song recording.
MIDI receive buffer overflow.	Displayed when too much MIDI data was received at one time and failed to proceed.
Over Current	Communication with the USB device has been shut down because of the overcurrent to the USB device. Disconnect the device from the USB TO DEVICE terminal, then turn on the power of the instrument.
Save OK ? [YES]/[NO]	Confirms whether saving is executed or not. Press the [+] (YES) button to save the recorded Song. To cancel saving, press the [-] (NO) button at the prompt.
Save data is not found.	Displayed when the data to be saved doesn't exist.
Since the media is in use now, this function is not available.	Indicates that the file control function is currently unavailable since the media is being accessed.
Since the recorded song has not been saved, the operation cannot be performed.	This message appears if you attempt to convert the User Song to audio file when there is any recorded Song which is not saved. When this message appears, press the [EXIT] button to exit from the FILE CONTROL display, then save the recorded Song which is not saved. To save the Song, hold down the [REC] button until the save confirmation message appears, then press the [+] (YES) button.
The limit of the media has been reached.	Indicates that saving data cannot be executed since the folder/directory structure has become too complicated.
The media is not formatted.	Indicates the inserted media has not been formatted.
The media is write-protected.	Indicates that the inserted media cannot be written since it is write-protected. Set to the write-protect switch to the "overwrite" position before use.
The notation cannot be displayed, since this song is not allowed to display the notation.	This message will appear if you attempt to display the score of a Song for which score display is prohibited.
The song data is too large to be converted to notation.	Indicates that the score cannot be displayed since the Song data is too large.
The number of files exceeds the system limit. Delete existing files to add new ones.	Indicates that saving data cannot be executed since the total number of files exceeds the capacity.
This drive is busy now.	This message appears when processing lags behind Audio playback or recording.
This function is not available now.	Indicates the designated function is not available since the instrument is executing another job.

## NOTE

- Not all the messages are listed in the table; only messages needing explanation are included.

# Specifications

<b>Product Name</b>		Digital Piano		
<b>Size/Weight</b>	Dimensions (W x D x H)		1,397 x 445 x 146 mm (55" x 17-1/2" x 5-3/4") with keyboard stand: 1,399 x 445 x 761 mm (55-1/16" x 17-1/2" x 29-15/16")	
	Weight		21kg (46 lbs. 5 oz.) with keyboard stand: 28kg (61 lbs. 12 oz.)	
<b>Control Interface</b>	Keyboard	Number of Keys	88	
		Type	GHS (Graded Hammer Standard) keyboard	
		Touch Response	Soft, Medium, Hard, Fixed	
	Other Controllers	Pitch Bend Wheel		Yes
		Display	Type	Full Dot LCD
	Size		320 x 240 dots	
	Color		Monochrome	
	Contrast		Yes	
	Score Display Function		Yes	
	Lyrics Display Function		Yes	
Panel	Language		English	
	Language		English	
<b>Voices</b>	Tone Generation	Piano Sound	Pure CF Sound Engine	
		Damper Resonance	Yes	
	Polyphony	Number of Polyphony (max.)	192	
	Preset	Number of Voices	151 + 15 Drum/SFX Kits + 388 XGlite	
		Featured Voices	1 Natural! Voice, 10 Live! Voices, 11 Sweet! Voices, 7 Cool! Voices	
Compatibility		GM, XGlite		
<b>Effects</b>	Types	Reverb	41 types	
		Chorus	44 types	
		DSP	237 types	
		Master EQ	5 types	
		Harmony	26 types	
		Intelligent Acoustic Control (IAC)	Yes	
	Mic Effects		Noise Gate, Compressor, 3 Band EQ	
	Functions	Dual		Yes
		Split		Yes
		Panel Sustain		Yes (Function Menu)
<b>Styles</b>	Preset	Number of Styles	205	
		Fingering	Multi Finger, Full Keyboard, AI Fingered	
		Style Control	INTRO, MAIN x 2, FILL-IN x 2, ENDING	
	Other Features	Music Database	320	
		One Touch Setting (OTS)	Yes	
		Style Recommender	Yes	
Smart Chord		Yes		
Compatibility		Style File Format (SFF), Style File Format GE (SFF GE)		
<b>Songs (MIDI)</b>	Preset	Number of Preset Songs	100	
	Recording	Number of Songs	5	
		Number of Tracks	6 (5 Melody + 1 Chord)	
		Data Capacity	Approx. 30,000 notes for 1 user song	
	Compatible Data Format	Playback	SMF (Format 0, Format 1), XF	
Recording		SMF (Format 0)		
USB Audio Recorder/Player		Recording Time (max.)	80 minutes/Song	
	Data Format	Playback	WAV (44.1 kHz, 16 bit, stereo)	
		Recording	WAV (44.1 kHz, 16 bit, stereo)	
<b>Functions</b>	Registration Memory	Number of Buttons	4 (x 8 banks)	
	Lesson	Yamaha Education Suite (Y.E.S.)	Waiting, Your tempo, Minus one, Repeat & Learn, Chord Dictionary	
	Demo		Yes	
	Overall Controls	Metronome		Yes
		Tempo		5 - 280
		Transpose		-12 to 0, 0 to +12
		Tuning		415.3 - 440.0 - 466.2 Hz
	Miscellaneous	Piano Room		Yes

<b>Storage and Connectivity</b>	Storage	Internal Memory	Approx. 1.7 MB
		External Drives	USB flash drive
	Connectivity	DC IN	12V
		Headphones/Output	x 1 (Standard stereo phone jack)
		Microphone	Yes (Standard phone jack)
		Sustain Pedal	Yes
		AUX IN	Yes (Stereo mini jack)
		PEDAL UNIT	Yes
USB TO DEVICE	Yes		
USB TO HOST	Yes		
<b>Amplifiers/ Speakers</b>	Amplifiers	6W x 2	
	Speakers	12cm x 2 + 5cm x 2	
<b>Power Supply</b>	Adaptor	PA-150 or the equivalent	
	Power Consumption	13W	
	Auto Power Off	Yes	
<b>Included Accessories</b>		<ul style="list-style-type: none"> <li>• Owner's Manual</li> <li>• Data List</li> <li>• Keyboard Stand</li> <li>• Footswitch</li> <li>• Music Rest</li> <li>• AC Power Adaptor (PA-150 or an equivalent recommended by Yamaha) <sup>*1</sup></li> <li>• Warranty <sup>*1</sup></li> <li>• Online Member Product Registration <sup>*2</sup></li> </ul> <p><sup>*1</sup>: May not be included depending on your area. Check with your Yamaha dealer.  <sup>*2</sup>: The PRODUCT ID on the sheet will be needed when you fill out the User Registration form.</p>	
<b>Separately Sold Accessories (May not be available depending on your area.)</b>		<ul style="list-style-type: none"> <li>• AC Power Adaptor: PA-150 or an equivalent recommended by Yamaha</li> <li>• Headphones: HPH-50/HPH-100/HPH-150</li> <li>• Pedal Unit: LP-7A/LP-7AWH</li> <li>• Foot Pedal: FC3A</li> <li>• Footswitch: FC4A/FC5</li> <li>• USB wireless LAN adaptor: UD-WL01</li> <li>• Wireless MIDI Adaptor: UD-BT01</li> </ul>	

\* The contents of this manual apply to the latest specifications as of the printing date. To obtain the latest manual, access the Yamaha website then download the manual file. Since specifications, equipment or separately sold accessories may not be the same in every locale, please check with your Yamaha dealer.

## Symbols

[-] and [+] buttons ..... 24

## A

A-B Repeat ..... 40  
 Access Point mode ..... 77, 79  
 Accessories ..... 8  
 ACMP ..... 32  
 Assembly ..... 12  
 Assignable Pedal ..... 21  
 Audio ..... 38, 66  
 Audio player ..... 76  
 AUDIO SELECT display ..... 39  
 Auto Accompaniment ..... 32  
 Auto Accompaniment range ..... 32  
 Auto Power Off ..... 19

## B

Background music (BGM) ..... 66  
 Backup ..... 52  
 Bank number ..... 50  
 Bell ..... 30

## C

CATEGORY buttons ..... 24  
 Channel ..... 68  
 Character entry ..... 83  
 Chord Dictionary ..... 65  
 Chord Fingering ..... 34, 64  
 Chorus ..... 53  
 Compatible format ..... 10  
 Computer ..... 76  
 Computer-related Operations ..... 8  
 Connection ..... 20, 21, 22, 76, 80  
 CONTRAST ..... 23  
 Convert ..... 85

## D

Damper Resonance ..... 21, 25  
 Data List ..... 8  
 Delete (from flash memory) ..... 87  
 Delete (from USB flash drive) ... 87  
 Delete (User Song) ..... 48  
 Demo ..... 38  
 Dial ..... 24  
 DSP ..... 54  
 Dual Voice ..... 28, 60

## E

Effect ..... 74  
 Ending ..... 61  
 EQ ..... 57

## F

Fast Forward ..... 40  
 File Control ..... 81  
 Fill-in ..... 61  
 Footswitch ..... 21  
 Formatting (USB flash drive) .... 82  
 Function List ..... 73

Functions ..... 72

## H

Half Pedal ..... 22  
 Harmony ..... 31  
 Headphones ..... 20

## I

Infrastructure mode ..... 77, 78  
 Initialization ..... 52  
 Intelligent Acoustic Control (IAC) ..... 19, 59  
 Intro ..... 61  
 iPhone/iPad ..... 77  
 iPhone/iPad Connection Manual .. 8

## L

Lesson ..... 42  
 Lid position ..... 25  
 Load ..... 86  
 Lyrics ..... 41

## M

Main ..... 61  
 MAIN display ..... 23  
 Main Voice ..... 27  
 Master EQ ..... 57  
 Messages ..... 89  
 Metronome ..... 29  
 MIC ..... 21, 71  
 Microphone ..... 69  
 MIDI ..... 44, 74  
 MIDI Reference ..... 8  
 Music Database ..... 33  
 Music Rest ..... 8  
 Mute ..... 40

## N

Number buttons ..... 24

## O

Output Gain Level ..... 58  
 Overview Demo ..... 38

## P

Panel settings ..... 50  
 Pause ..... 40  
 Pedal unit ..... 22  
 Piano Reset ..... 27  
 Piano Room ..... 25  
 Pitch ..... 25, 55, 56  
 PITCH BEND wheel ..... 56  
 Playback ..... 39  
 Portamento ..... 21  
 Power On/Off ..... 18  
 Power requirements ..... 18  
 Practice ..... 42

## Q

Quantize ..... 75

## R

Random Playback ..... 66  
 Recording (Audio) ..... 49  
 Recording (Piano Room) ..... 26  
 Recording (Song Track) ..... 46  
 Recording (Song) ..... 44  
 Registration Memory ..... 50  
 Repeat & Learn ..... 43  
 Repeat playback ..... 40  
 Reverb ..... 53  
 Rewind ..... 40  
 Rhythm ..... 32

## S

Save (USB flash drive) ..... 83, 84  
 Score ..... 41  
 Sections ..... 61  
 Smart Chord ..... 35  
 Song ..... 38, 66  
 Song Book ..... 8  
 SONG SELECT display ..... 39  
 Speaker On/Off ..... 58  
 Split Point ..... 32, 64  
 Split Voice ..... 28, 60  
 Stop Accompaniment ..... 63  
 Style ..... 32, 61  
 Style Recommender ..... 37  
 Sustain ..... 21, 55  
 Synchro Start ..... 33, 61  
 Synchro Stop ..... 62

## T

Tap Start ..... 63  
 Tap Tempo ..... 21  
 Tempo ..... 63  
 Time signature ..... 29  
 Touch Response ..... 25, 57  
 Track On/Off ..... 40  
 Transpose ..... 55  
 Troubleshooting ..... 88  
 Tuning ..... 25, 56

## U

USB Flash Drive ..... 80  
 USER FILES folder ..... 82, 83, 86  
 User Song ..... 44

## V

Voice ..... 27, 60  
 Volume (Audio) ..... 67  
 Volume (Main Voice, Dual Voice, Split Voice) ..... 73  
 Volume (Master) ..... 19  
 Volume (Song) ..... 67  
 Volume (Style) ..... 63

## W

Wireless LAN ..... 77  
 WPS ..... 78

## IMPORTANT NOTICE FOR THE UNITED KINGDOM

### Connecting the Plug and Cord

IMPORTANT. The wires in this mains lead are coloured in accordance with the following code:

BLUE : NEUTRAL  
BROWN : LIVE

As the colours of the wires in the mains lead of this apparatus may not correspond with the coloured markings identifying the terminals in your plug proceed as follows:

The wire which is coloured BLUE must be connected to the terminal which is marked with the letter N or coloured BLACK.

The wire which is coloured BROWN must be connected to the terminal which is marked with the letter L or coloured RED.

Making sure that neither core is connected to the earth terminal of the three pin plug.

(2 wires)

### OBSERVERA!

Apparaten kopplas inte ur växelströmskällan (nätet) så länge som den är ansluten till vägguttaget, även om själva apparaten har stängts av.

**ADVARSEL:** Netspændingen til dette apparat er IKKE afbrudt, så længe netledningen sidder i en stikkontakt, som er tændt — også selvom der er slukket på apparatets afbryder.

**VAROITUS:** Laitteen toisiopiiriin kytketty käyttökytin ei irroita koko laitetta verkosta.

(standby)

### Information for Users on Collection and Disposal of Old Equipment



This symbol on the products, packaging, and/or accompanying documents means that used electrical and electronic products should not be mixed with general household waste.

For proper treatment, recovery and recycling of old products, please take them to applicable collection points, in accordance with your national legislation and the Directives 2002/96/EC.

By disposing of these products correctly, you will help to save valuable resources and prevent any potential negative effects on human health and the environment which could otherwise arise from inappropriate waste handling.

For more information about collection and recycling of old products, please contact your local municipality, your waste disposal service or the point of sale where you purchased the items.

#### [For business users in the European Union]

If you wish to discard electrical and electronic equipment, please contact your dealer or supplier for further information.

#### [Information on Disposal in other Countries outside the European Union]

This symbol is only valid in the European Union. If you wish to discard these items, please contact your local authorities or dealer and ask for the correct method of disposal.

(weee\_eu\_en\_01)

# Important Notice: Guarantee Information for customers in European Economic Area (EEA) and Switzerland

<b>Important Notice: Guarantee Information for customers in EEA* and Switzerland</b> For detailed guarantee information about this Yamaha product, and Pan-EEA* and Switzerland warranty service, please either visit the website address below. (Printable file is available at our website) or contact the Yamaha representative office for your country. * EEA: European Economic Area	<b>English</b>
<b>Wichtiger Hinweis: Garantie-Information für Kunden in der EWR* und der Schweiz</b> Für nähere Garantie-Information über dieses Produkt von Yamaha, sowie über den Pan-EWR*- und Schweizer Garantieservice, besuchen Sie bitte entweder die folgend angegebene Internetadresse (eine druckfähige Version befindet sich auch auf unserer Webseite), oder wenden Sie sich an den für Ihr Land zuständigen Yamaha-Vertrieb. *EWR: Europäischer Wirtschaftsraum	<b>Deutsch</b>
<b>Remarque importante: informations de garantie pour les clients de l'EEE et la Suisse</b> Pour des informations plus détaillées sur la garantie de ce produit Yamaha et sur le service de garantie applicable dans l'ensemble de l'EEE ainsi qu'en Suisse, consultez notre site Web à l'adresse ci-dessous (le fichier imprimable est disponible sur notre site Web) ou contactez directement Yamaha dans votre pays de résidence. * EEE: Espace Economique Européen	<b>Français</b>
<b>Belangrijke mededeling: Garantie-informatie voor klanten in de EER* en Zwitserland</b> Voor gedetailleerde garantie-informatie over dit Yamaha-product en de garantieservice in heel de EER* en Zwitserland, gaat u naar de onderstaande website (u vindt een afdrukbaar bestand op onze website) of neemt u contact op met de vertegenwoordiging van Yamaha in uw land. * EER: Europese Economische Ruimte	<b>Nederlands</b>
<b>Aviso importante: información sobre la garantía para los clientes del EEE* y Suiza</b> Para una información detallada sobre este producto Yamaha y sobre el soporte de garantía en la zona EEE*, y Suiza, visite la dirección web que se incluye más abajo (la versión del archivo para imprimir está disponible en nuestro sitio web) o póngase en contacto con el representante de Yamaha en su país. * EEE: Espacio Económico Europeo	<b>Español</b>
<b>Aviso importante: informazioni sulla garanzia per i clienti residenti nell'EEA* e in Svizzera</b> Per informazioni dettagliate sulla garanzia relativa a questo prodotto Yamaha e l'assistenza in garanzia nei paesi EEA* e in Svizzera, potete consultare il sito Web all'indirizzo riportato di seguito (è disponibile il file in formato stampabile) oppure contattate l'ufficio di rappresentanza locale della Yamaha. * EEA: Area Economica Europea	<b>Italiano</b>
<b>Aviso importante: informações sobre as garantias para clientes da AEE* e da Suíça</b> Para obter uma informação pormenorizada sobre este produto da Yamaha e sobre o serviço de garantia na AEE* e na Suíça, visite o site a seguir (o arquivo para impressão está disponível no nosso site) ou entre em contato com o escritório de representação da Yamaha no seu país. * AEE: Área Económica Europeia	<b>Português</b>
<b>Σημαντική σημείωση: Πληροφορίες εγγύησης για τους πελάτες στον ΕΟΧ* και Ελβετία</b> Για λεπτομερείς πληροφορίες εγγύησης σχετικά με το παρόν προϊόν της Yamaha και την κάλυψη εγγύησης σε όλες τις χώρες του ΕΟΧ και την Ελβετία, επισκεφτείτε την παρακάτω ιστοσελίδα (Εκτυπώσιμη μορφή είναι διαθέσιμη στην ιστοσελίδα μας) ή απευθυνθείτε στην αντιπροσωπεία της Yamaha στη χώρα σας. * ΕΟΧ: Ευρωπαϊκός Οικονομικός Χώρος	<b>Ελληνικά</b>
<b>Viktigt: Garantierinformation för kunder i EES-området* och Schweiz</b> För detaljerad information om denna Yamaha-produkt samt garantier i hela EES-området* och Schweiz kan du antingen besöka nedanstående webbadress (en utskriftsvärdig fil finns på webbplatsen) eller kontakta Yamahas officiella representant i ditt land. * EES: Europeiska Ekonomiska Samarbetsområdet	<b>Svenska</b>
<b>Viktig merknad: Garantierinformasjon for kunder i EØS* og Sveits</b> Detaljert garantiinformasjon om dette Yamaha-produktet og garantier i hele EØS-området* og Sveits kan fås enten ved å besøke nettsidene nedenfor (utskriftsversjon finnes på våre nettsider) eller kontakte kontaktpunktet i landet der du bor. *EØS: Det europeiske økonomiske samarbeidsområdet	<b>Norsk</b>
<b>Vigtig oplysning: Garantierplysninger til kunder i EØO* og Schweiz</b> De kan finde detaljerede garantierplysninger om dette Yamaha-produkt og dets garantier i hele EØO* (og Schweiz) ved at besøge det websted, der er angivet nedenfor (der findes en fil, som kan udskrives, på vores websted), eller ved at kontakte Yamahas nationale repræsentationskontor i det land, hvor De bor. * EØO: Det Europæiske Økonomiske Område	<b>Dansk</b>

<b>Tärkeä ilmoitus: Takuuehdot Euroopan talousalueen (ETA)* ja Sveitsin asiakkaille</b> Tämän Yamaha-tuotteen sekä ETA-alueen ja Sveitsin takuuta koskevat yksityiskohtaiset tiedot saatte alla olevasta nettiosoitteesta. (Tulostettava liidosto saatavissa sivustollamme.) Voitte myös ottaa yhteyttä paikalliseen Yamaha-edustajaajaan. *ETA: Euroopan talousalue	<b>Suomi</b>
<b>Ważne: Warunki gwarancyjne obowiązujące w EOG* i Szwajcarii</b> Aby dowiedzieć się więcej na temat warunków gwarancyjnych tego produktu firmy Yamaha i serwisu gwarancyjnego w całym EOG* i Szwajcarii, należy odwiedzić wskazaną poniżej stronę internetową (plik gotowy do wydruku znajduje się na naszej stronie internetowej) lub skontaktować się z przedstawicielstwem firmy Yamaha w swoim kraju. * EOG — Europejski Obszar Gospodarczy	<b>Polski</b>
<b>Důležitě oznámení: Záruční informace pro zákazníky v EHS* a ve Švýcarsku</b> Podrobnější informace o tomto produktu Yamaha a záručním servisu v celém EHS* a ve Švýcarsku naleznete na níže uvedené webové adrese (soubor k tisku je dostupný na našich webových stránkách) nebo se můžete obrátit na zastoupení firmy Yamaha ve své zemi. * EHS: Evropský hospodářský prostor	<b>Česky</b>
<b>Fontos figyelemzés: Garancia-információk az EGT* területén és Svájcban élő vásárlók számára</b> A jelen Yamaha termékre vonatkozó részletes garancia-információk, valamint az EGT*-re és Svájcra kiterjedő garanciális szolgáltatás tekintetében keressék fel webhelyünket az alábbi címen (a webhelyen nyomtatható fájl is talál), vagy pedig lépjen kapcsolatba az országában működő Yamaha képviselőirodával. * EGT: Európai Gazdasági Térség	<b>Magyar</b>
<b>Oluline märkus: Garantiteave Euroopa Majanduspiirkonna (EMP)* ja Šveitsi klientidele</b> Täpsema teabe saamiseks selle Yamaha toote garantii ning kogu Euroopa Majanduspiirkonna ja Šveitsi garantiteeninduse kohta, külastage palun veebisaiti alljärgneval aadressil (meie saidil on saadaval printitav fail) või pöörduge Teie riigioni Yamaha esinduse poole. * EMP: Euroopa Majanduspiirkond	<b>Eesti keel</b>
<b>Svarigs paziņojums: garantijas informācija klientiem EEZ* un Šveicā</b> Lai saņemtu detalizētākas garantijas informāciju par šo Yamaha produktu, kā arī garantijas apkalpošanu EEZ* un Šveicā, lūdzam apmeklēt zemāk norādīto tīmekļa vietnes adresi (tīmekļa vietnē ir pieejams arī lejupielāmes fails) vai sazināties ar Jūsu valstī apliecināto Yamaha pārstāvniecību. * EEZ: Eiropas Ekonomikas zona	<b>Latviešu</b>
<b>Dėmesio: informacija dėl garantijos pirkėjams EEE* ir Šveicarijoje</b> Jei reikia išsamesnės informacijos apie šį „Yamaha“ produktą (jo techninę priežiūrą visoje EEE* ir Šveicarijoje, apsilankykite mūsų svetainėje toliau nurodytu adresu (svetainėje yra spausdinamas failas) arba kreipkitės į „Yamaha“ atstovybę savo šalyje. *EEE – Europos ekonominė erdvė	<b>Lietuvių kalba</b>
<b>Dôležité upozornenie: Informácie o záruke pre zákazníkov v EHP* a Švajčiarsku</b> Podrobnejšie informácie o záruke týkajúcej sa tohto produktu od spoločnosti Yamaha a garancijnom servise v EHP* a Švajčiarsku nájdete na webovej stránke uvedenej nižšie (na našej webovej stránke je k dispozícii súbor na tlač) alebo sa obráťte na zástupcu spoločnosti Yamaha vo svojej krajine. * EHP: Európsky hospodársky priestor	<b>Slovenčina</b>
<b>Pomembno obvestilo: Informacije o garanciji za kupce v EGP* in Švici</b> Za podrobnejše informacije o tem Yamaha izdelku ter garancijskem servisu v celotnem EGP in Švici, obiščite spletno mesto, ki je navedeno spodaj (natisljiva datoteka je na voljo na našem spletnem mestu), ali se obrnite na Yamahinega predstavnik v svoji državi. * EGP: Evropski gospodarski prostor	<b>Slovenščina</b>
<b>Важно съобщение: Информация за гаранцията за клиенти в ЕИПТ* и Швейцария</b> За подробна информация за гаранцията за този продукт на Yamaha и гаранционното обслужване в паневропейската зона на ЕИПТ* и Швейцария или посетете посочения по-долу уеб сайт (на нашия уеб сайт има файл за печат), или се свържете с представителния офис на Yamaha във вашата страна. *ЕИПТ: Европейско икономическо пространство	<b>Български език</b>
<b>Notificare importantă: Informații despre garanție pentru clienții din SEE* și Elveția</b> Pentru informații detaliate privind acest produs Yamaha și serviciul de garanție Pan-SEE* și Elveția, vizitați site-ul la adresa de mai jos (fișierul imprimabil este disponibil pe site-ul nostru) sau contactați biroul reprezentanței Yamaha din țara dumneavoastră. * SEE: Spațiul Economic European	<b>Limba română</b>

<http://europe.yamaha.com/warranty/>

For details of products, please contact your nearest Yamaha representative or the authorized distributor listed below.

## NORTH AMERICA

### CANADA

**Yamaha Canada Music Ltd.**  
135 Milner Avenue, Toronto, Ontario M1S 3R1,  
Canada  
Tel: +1-416-298-1311

### U.S.A.

**Yamaha Corporation of America**  
6600 Orangethorpe Avenue, Buena Park, CA 90620,  
U.S.A.  
Tel: +1-714-522-9011

## CENTRAL & SOUTH AMERICA

### MEXICO

**Yamaha de México, S.A. de C.V.**  
Av. Insurgentes Sur 1647 Piso 9, Col. San José  
Insurgentes, Delegación Benito Juárez, México,  
D.F., C.P. 03900  
Tel: +52-55-5804-0600

### BRAZIL

**Yamaha Musical do Brasil Ltda.**  
Rua Fidêncio Ramos, 302 – Cj 52 e 54 – Torre B –  
Vila Olímpia – CEP 04551-010 – São Paulo/SP,  
Brazil  
Tel: +55-11-3704-1377

### ARGENTINA

**Yamaha Music Latin America, S.A.,  
Sucursal Argentina**  
Olga Cossetini 1553, Piso 4 Norte,  
Madero Este-C1107CEK,  
Buenos Aires, Argentina  
Tel: +54-11-4119-7000

### VENEZUELA

**Yamaha Musical de Venezuela, C.A.**  
AV. Manzanares, C.C. Manzanares Plaza,  
Piso 4, Oficina 0401, Baruta, Caracas, Venezuela  
Tel: +58-212-943-1877

### PANAMA AND OTHER LATIN

### AMERICAN COUNTRIES/ CARIBBEAN COUNTRIES

**Yamaha Music Latin America, S.A.**  
Edif. Torre Banco General, F7, Urb. Marbella,  
Calle 47 y Aquilino de la Guardia, Panama,  
P.O.Box 0823-05863, Panama, Rep.de Panama  
Tel: +507-269-5311

## EUROPE

### THE UNITED KINGDOM/IRELAND

**Yamaha Music Europe GmbH (UK)**  
Sherbourne Drive, Tilbrook, Milton Keynes,  
MK7 8BL, U.K.  
Tel: +44-1908-366700

### GERMANY

**Yamaha Music Europe GmbH**  
Siemensstrasse 22-34, 25462 Rellingen, Germany  
Tel: +49-4101-303-0

### SWITZERLAND/LIECHTENSTEIN

**Yamaha Music Europe GmbH, Rellingen,  
Branch Switzerland in Zürich**  
Seefeldstrasse 94, 8008 Zürich, Switzerland  
Tel: +41-44-3878080

### AUSTRIA

**Yamaha Music Europe GmbH, Branch Austria**  
Schleiergasse 20, 1100 Wien, Austria  
Tel: +43-1-60203900

### CZECH REPUBLIC/HUNGARY/ ROMANIA/SLOVAKIA/SLOVENIA

**Yamaha Music Europe GmbH, Branch Austria**  
Schleiergasse 20, 1100 Wien, Austria  
Tel: +43-1-60203900

### POLAND/LITHUANIA/LATVIA/ ESTONIA

**Yamaha Music Europe GmbH**  
Sp.z o.o. Oddzial w Polsce  
ul. Wrotkowa 14, 02-553 Warsaw, Poland  
Tel: +48-22-880-08-88

### BULGARIA

**Dinacord Bulgaria LTD.**  
Bul. Iskarsko Schose 7 Targowski Zentar Ewropa  
1528 Sofia, Bulgaria  
Tel: +359-2-978-20-25

### MALTA

**Olimpus Music Ltd.**  
Valletta Road, Mosta MST9010, Malta  
Tel: +356-2133-2093

### NETHERLANDS/BELGIUM/ LUXEMBOURG

**Yamaha Music Europe, Branch Benelux**  
Clarissenhof 5b, 4133 AB Vianen, The Netherlands  
Tel: +31-347-358040

### FRANCE

**Yamaha Music Europe**  
7 rue Ambroise Croizat, Zone d'activités de Pariest,  
77183 Croissy-Beaubourg, France  
Tel: +33-1-6461-4000

### ITALY

**Yamaha Music Europe GmbH, Branch Italy**  
Viale Italia 88, 20020, Lainate (Milano), Italy  
Tel: +39-02-93577-1

### SPAIN/PORTUGAL

**Yamaha Music Europe GmbH Ibérica, Sucursal  
en España**  
Ctra. de la Coruna km. 17,200, 28231  
Las Rozas de Madrid, Spain  
Tel: +34-91-639-88-88

### GREECE

**Philippos Nakas S.A. The Music House**  
19th km. Leof. Lavriou 190 02 Peania – Attiki,  
Greece  
Tel: +30-210-6686260

### SWEDEN

**Yamaha Music Europe GmbH Germany filial  
Scandinavia**  
JA Wettergrensgata 1, 400 43 Göteborg, Sweden  
Tel: +46-31-89-34-00

### DENMARK

**Yamaha Music Denmark,  
Filial of Yamaha Music Europe GmbH, Tyskland**  
Generatorvej 8C, ST. TH., 2860 Søborg, Denmark  
Tel: +45-44-92-49-00

### FINLAND

**F-Musiikki Oy**  
Antaksentie 4  
FI-01510 Vantaa, Finland  
Tel: +358 (0)96185111

### NORWAY

**Yamaha Music Europe GmbH Germany -  
Norwegian Branch**  
Grini Næringspark 1, 1361 Østerås, Norway  
Tel: +47-6716-7800

### ICELAND

**Hljodfaerahusid Ehf.**  
Sidumula 20  
IS-108 Reykjavik, Iceland  
Tel: +354-525-5050

### CROATIA

**Euro Unit D.O.O.**  
Slakovec 73  
40305 Nedelisce  
Tel: +38540829400

### RUSSIA

**Yamaha Music (Russia) LLC.**  
Room 37, entrance 7, bld. 7, Kievskaya street,  
Moscow, 121059, Russia  
Tel: +7-495-626-5005

### OTHER EUROPEAN COUNTRIES

**Yamaha Music Europe GmbH**  
Siemensstrasse 22-34, 25462 Rellingen, Germany  
Tel: +49-4101-303-0

## AFRICA

**Yamaha Music Gulf FZE**  
JAFZA-16, Office 512, P.O.Box 17328,  
Jebel Ali FZE, Dubai, UAE  
Tel: +971-4-801-1500

## MIDDLE EAST

### TURKEY

**Yamaha Music Europe GmbH  
Merkezi Almanya Türkiye Istanbul Şubesi**  
Maslak Meydanı Sokak, Spring Giz Plaza Bagimsiz  
Böl. No:3, Şanier İstanbul, Turkey  
Tel: +90-212-999-8010

### CYPRUS

**Nakas Music Cyprus Ltd.**  
Nikis Ave 2k  
1086 Nicosia  
Tel: + 357-22-511080  
**Major Music Center**  
21 Ali Riza Ave. Ortakoy  
P.O.Box 475 Nicosia, Cyprus  
Tel: (392) 227 9213

### OTHER COUNTRIES

**Yamaha Music Gulf FZE**  
JAFZA-16, Office 512, P.O.Box 17328,  
Jebel Ali FZE, Dubai, UAE  
Tel: +971-4-801-1500

## ASIA

### THE PEOPLE'S REPUBLIC OF CHINA

**Yamaha Music & Electronics (China) Co., Ltd.**  
2F, Yunhedasha, 1818 Xinzha-lu, Jingan-qu,  
Shanghai, China  
Tel: +86-400-051-7700

### HONG KONG

**Tom Lee Music Co., Ltd.**  
11/F., Silvercord Tower 1, 30 Canton Road,  
Tsimshatsui, Kowloon, Hong Kong  
Tel: +852-2737-7688

### INDIA

**Yamaha Music India Private Limited**  
Spazedge Building, Ground Floor, Tower A,  
Sector-47, Gurgaon- Sohna Road, Gurgaon-122002,  
Haryana, India  
Tel: +91-124-485-3300

### INDONESIA

**PT. Yamaha Musik Indonesia (Distributor)**  
Yamaha Music Center Bldg. Jalan Jend. Gatot  
Subroto Kav. 4, Jakarta 12930, Indonesia  
Tel: +62-21-520-2577

### KOREA

**Yamaha Music Korea Ltd.**  
8F, Dongsung Bldg. 21, Teheran-ro 87-gil,  
Gangnam-gu, Seoul, 135-880, Korea  
Tel: +82-2-3467-3300

### MALAYSIA

**Yamaha Music (Malaysia) Sdn. Bhd.**  
No.8, Jalan Perbandaran, Kelana Jaya, 47301  
Petaling Jaya, Selangor, Malaysia  
Tel: +60-3-78030900

### SINGAPORE

**Yamaha Music (Asia) Private Limited**  
Block 202 Hougang Street 21, #02-00,  
Singapore 530202, Singapore  
Tel: +65-6740-9200

### TAIWAN

**Yamaha Music & Electronics Taiwan Co., Ltd.**  
2F., No.1, Yuandong Rd. Banqiao Dist.  
New Taipei City 22063, Taiwan  
Tel: +886-2-7741-8888

### THAILAND

**Siam Music Yamaha Co., Ltd.**  
3, 4, 15, 16th Fl., Siam Motors Building,  
891/1 Rama 1 Road, Wangmai,  
Pathumwan, Bangkok 10330, Thailand  
Tel: +66-2215-2622

### VIETNAM

**Yamaha Music Vietnam Company Limited**  
15th Floor, Nam A Bank Tower, 201-203 Cach  
Mang Thang Tam St., Ward 4, Dist.3,  
Ho Chi Minh City, Vietnam  
Tel: +84-8-3818-1122

### OTHER ASIAN COUNTRIES

<http://asia.yamaha.com>

## OCEANIA

### AUSTRALIA

**Yamaha Music Australia Pty. Ltd.**  
Level 1, 99 Queensbridge Street, Southbank,  
Vic, 3006, Australia  
Tel: +61-3-9693-5111

### NEW ZEALAND

**Music Works LTD**  
P.O.BOX 6246 Wellesley, Auckland 4680,  
New Zealand  
Tel: +64-9-634-0099

### COUNTRIES AND TRUST TERRITORIES IN PACIFIC OCEAN

<http://asia.yamaha.com>



Yamaha Global Site  
<http://www.yamaha.com/>

Yamaha Downloads  
<http://download.yamaha.com/>

Manual Development Department  
© 2015 Yamaha Corporation

Published 10/2015 POGR\*. \*-\*A0  
Printed in Indonesia

ZS39130



ZS39130