

A-S2000

Stereo Amplifier *Amplificateur Stéréo*



HiFi Began with Yamaha

Yamaha's involvement with and passion for music goes back more than a century, to when we built our first reed organ in 1887. Now we are the world's leading producer of pianos and other musical instruments, and are involved with music in many other ways as well. We manufacture professional recording equipment, we design concert halls and we assist artists at concerts with set up and sound tuning.

This knowledge and experience benefits our production of audio components in many ways. We introduced our first HiFi (High Fidelity) turntable in 1954. Thereafter we were one of the first to offer mass-produced, high quality audio equipment, and introduced many legendary stereo components.

We hope you enjoy the genuine HiFi experience of Yamaha Natural Sound.



Excellence in Audio Achievement

1920-
1960s

First HiFi System introduced in 1920

We introduced numerous HiFi components (turntables, FM/AM tuners, integrated amplifiers, preamplifiers, power amplifiers and speakers) in 1955 - 1965.

Natural Sound Speaker Series introduced in 1967

NS-20 Monitor Speaker



NS-20



CA-1000

1970s

CA-1000 Integrated Amplifier

Featuring A-Class operation, the CA-1000 set the standard for integrated amplifiers.

NS-690 Monitor Speaker



NS-690



NS-1000M

NS-1000M Monitor Speaker

A truly legendary speaker still revered by HiFi enthusiasts.

B-1 Power Amplifier

An innovative power amp that used FETs in all stages.

C-2 Control Amplifier

Received top prize at the Milan International Music and HiFi Show.

NS-10M Studio Monitor Speaker

Became of the most popular studio monitors in the world.

A-1 Integrated Amplifier

PX-2 Turntable

Yamaha's first straight arm turntable.



B-1



C-2



PX-2



NS-10M



A-1

1980s

B-6 Power Amplifier

Pyramid-shaped power amplifier.

GT-2000/L Turntable

First CD Player (CD-1) introduced in 1983

B-2x Power Amplifier

MX-10000 Power Amplifier and

CX-10000 Control Amplifier

Redefined the capabilities of separate components.

AX-1 Integrated Amplifier



B-6



B-2x



MX-10000



CX-10000

1990s

GT-CD1 CD Player

MX-1 Power Amplifier and

CX-1 Preamplifier

2000s

Soavo-1 and Soavo-2 Natural Sound Speaker Systems

A-S2000 Stereo Amplifier and

CD-S2000 Super Audio CD Player



Soavo-1



Soavo-2

A-S2000

◆ *Full floating and balanced circuit design achieves for the first time the full potential of analogue amplification*

An entirely new floating and balanced power amp achieves complete symmetry and permits full balanced transmission (amplification) from the input jack to just before the speaker jack

◆ *Full-stage balanced signal transmission*

The world's first integrated amp to offer full stage balanced transmission, combining high power output with good sound texture and outstanding S/N performance

◆ *Floating and balanced power amp*

◆ *Fully balanced control amp*

◆ *Fully balanced digital volume and tone controls*

◆ *Four large capacity power supplies*

◆ *Symmetrical construction*

◆ *Headphone amp for low impedance drive*

■ **Supplied accessories**

Please check that you have received all of the following parts.

- Remote control
- Batteries (AA, R6, UM-3) (×2)
- Power cable
- Safety brochure

Contents

Controls and functions.....	6
Connections.....	14
Specifications	20
Troubleshooting.....	24

■ **About this manual**

- ✨ indicates a tip for your operation.
- This manual is printed prior to production. Design and specifications are subject to change in part as a result of improvements, etc. In case of differences between the manual and the product, the product has priority.
- The color of images in this manual may vary from the original.
- Read the safety brochure before using this unit.

A-S2000

Controls and functions

In this chapter, you will learn the controls and functions of A-S2000.

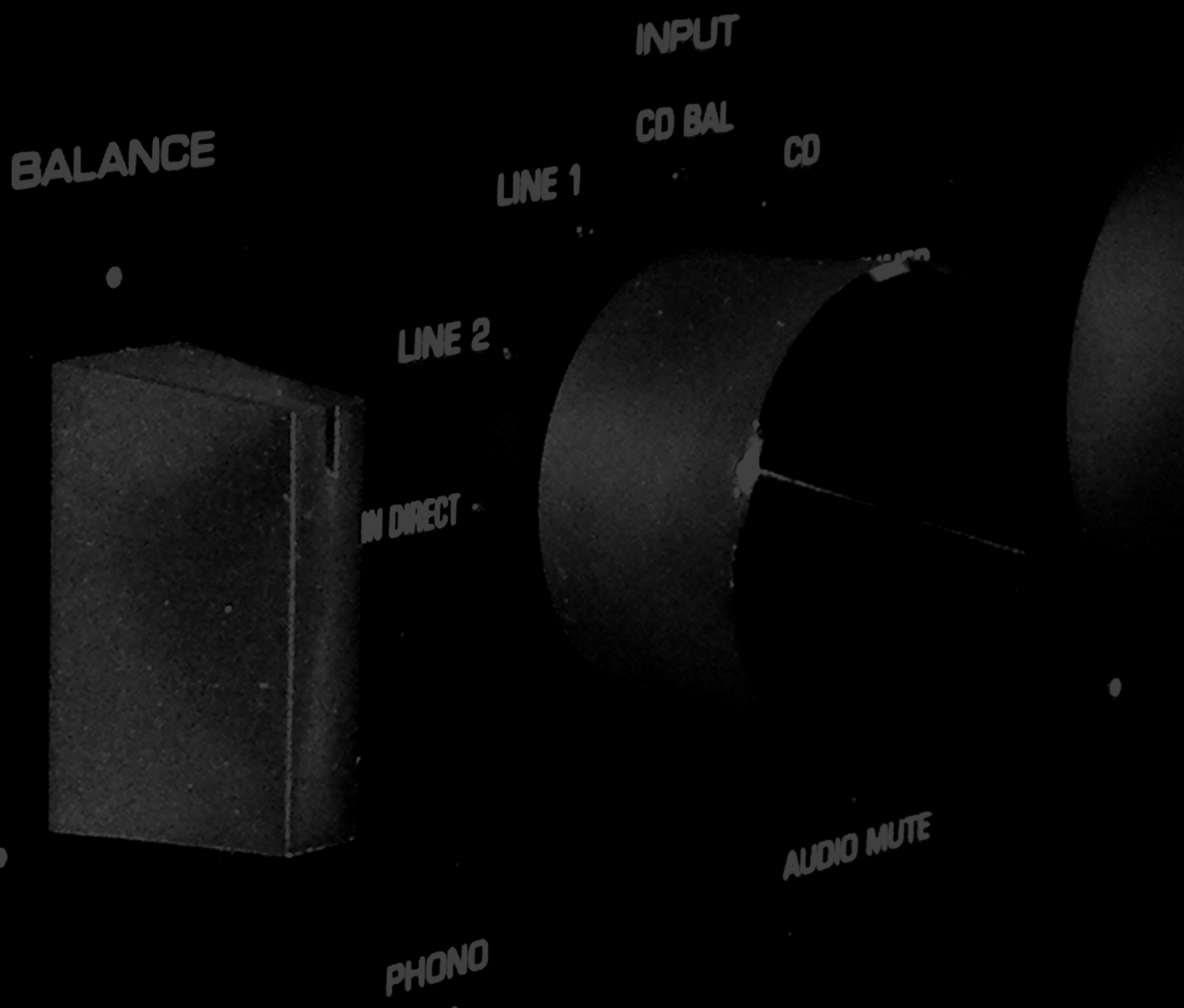

Controls and functions

■ Front panel (left side)

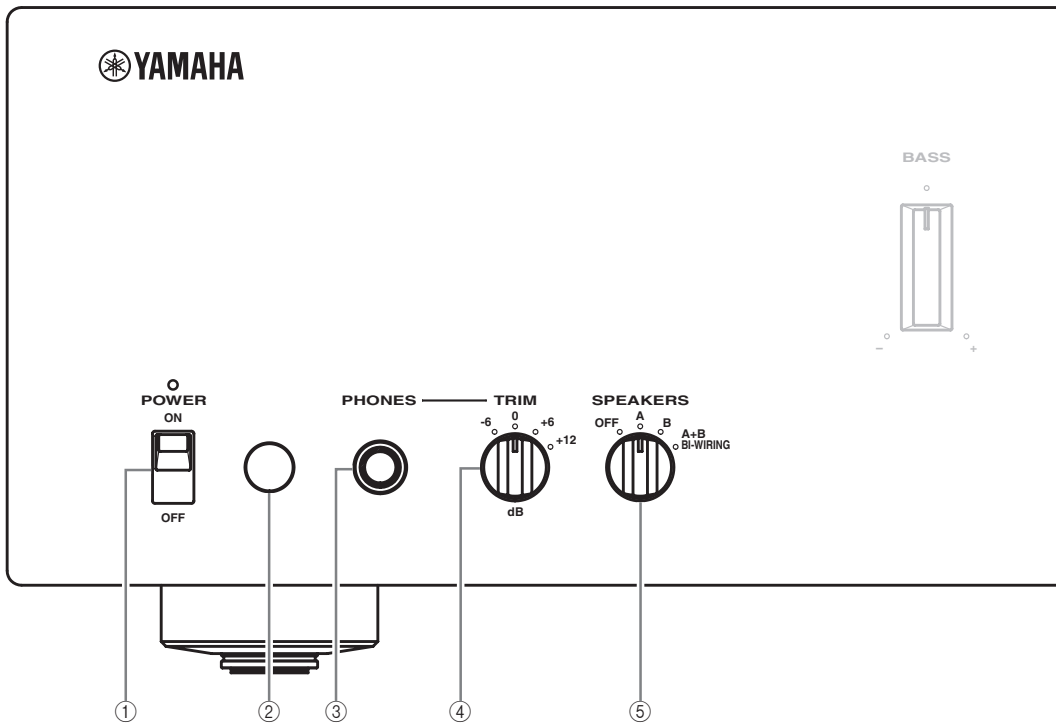

① POWER

Press upward or downward to turn on or off this unit.



The POWER indicator above lights up when this unit is turned on.

Notes

- If the POWER indicator flashes when you turn on this unit, disconnect the AC power cable and contact the nearest authorized Yamaha dealer or service center (see page 24).
- When you turn on this unit, there will be a few second delay before this unit can reproduce sound.

② Remote control sensor

Receives signals from the remote control.

The remote control transmits a directional infrared beam. Be sure to aim the remote control directly at the remote control sensor on the front panel of this unit during operation.

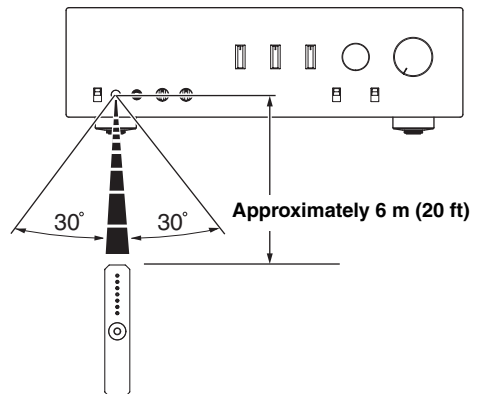

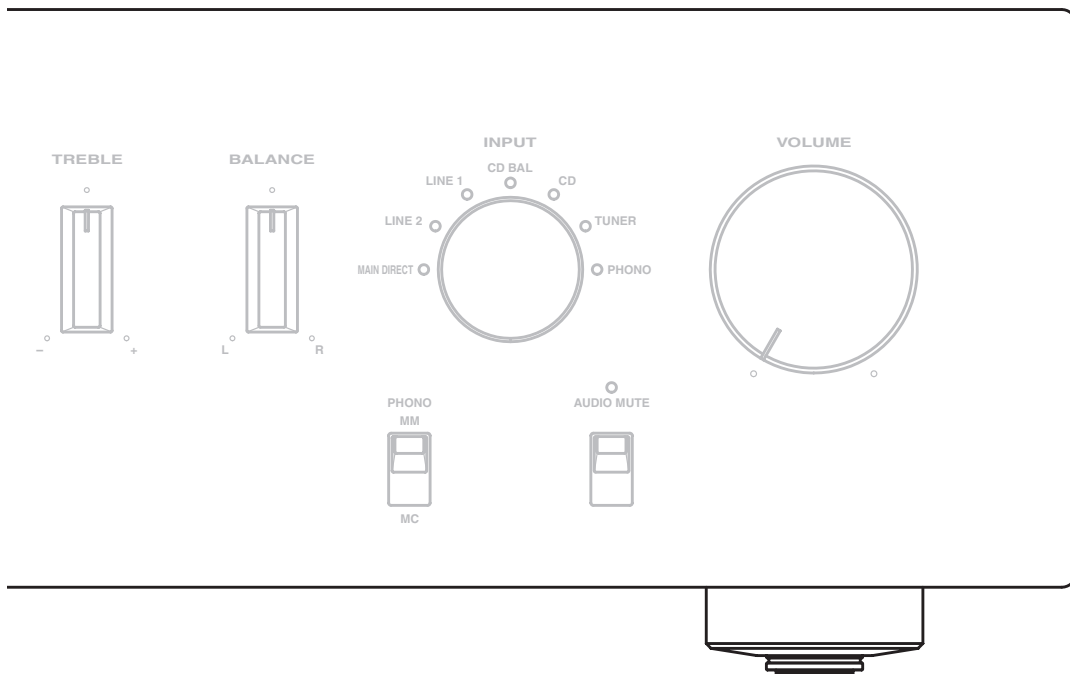

③ PHONES jack

Outputs audio for private listening with headphones.

Note

When headphones are plugged in:

- Both speaker sets connected to the SPEAKERS L/R CH A and B terminals are turned off.
- No signals are output at the PRE OUT jacks, while signals are output at the REC jacks.
- You cannot select MAIN DIRECT as the input source.
- If headphones are plugged into the PHONES jack while MAIN DIRECT is selected as the input source, no audio is output at the PHONES jack.

④ TRIM

Adjusts the volume level when headphones are plugged in to avoid sudden changes in volume.

Choices: -6 dB, 0 dB, +6 dB, +12 dB

⑤ SPEAKERS

Turns on or off the speaker set connected to the SPEAKERS L/R CH A and/or B terminals on the rear panel.

- Switch to the OFF position to turn off both speaker sets.
- Switch to the A or B position to turn on the speaker set connected to the SPEAKERS L/R CH A or B terminals.
- Switch to the A+B BI-WIRING position to turn on both speaker sets.

Caution

If you use two sets (A and B), the impedance of each speaker must be 8 Ω or higher.

Controls and functions

■ Front panel (right side)

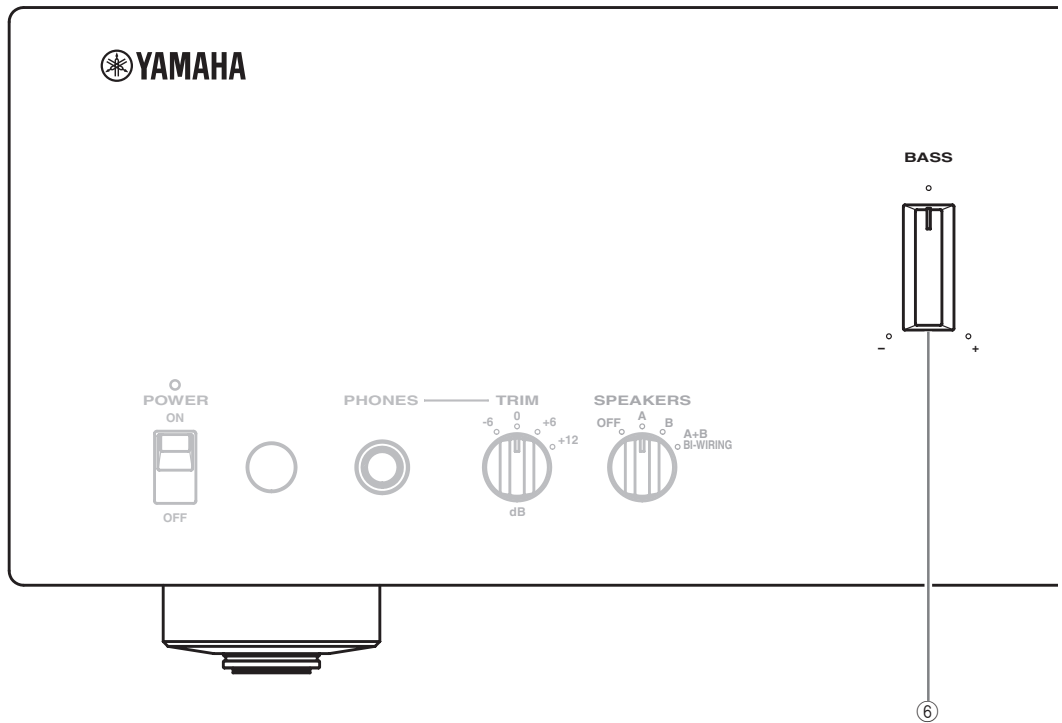

⑥ BASS

Increases or decreases the low frequency response. The 0 position produces a flat response.
Control range: -10 dB to +10 dB

⑦ TREBLE

Increases or decreases the high frequency response. The 0 position produces a flat response.
Control range: -10 dB to +10 dB

Notes

- When both the BASS and TREBLE controls are set to the 0 position, audio signal bypasses the tone control circuitry.
- The BASS and TREBLE controls do not affect the signals input at the MAIN DIRECT jacks and signals output at the REC OUT jacks.

⑧ BALANCE

Adjusts the audio output balance of the left and right speakers to compensate for sound imbalances caused by speaker locations or listening room conditions.

Note

The BALANCE control does not affect the signals input at the MAIN DIRECT jacks and signals output at the REC OUT jacks.

⑨ PHONO

Selects the type of magnetic cartridge of the turntable connected to the PHONO jacks on the rear panel.

- Press upward to the MM position when the connected turntable has a moving magnet (MM) cartridge.
- Press downward to the MC position when the connected turntable has a moving coil (MC) cartridge.
- When you replace the cartridge, be sure to turn off this unit.

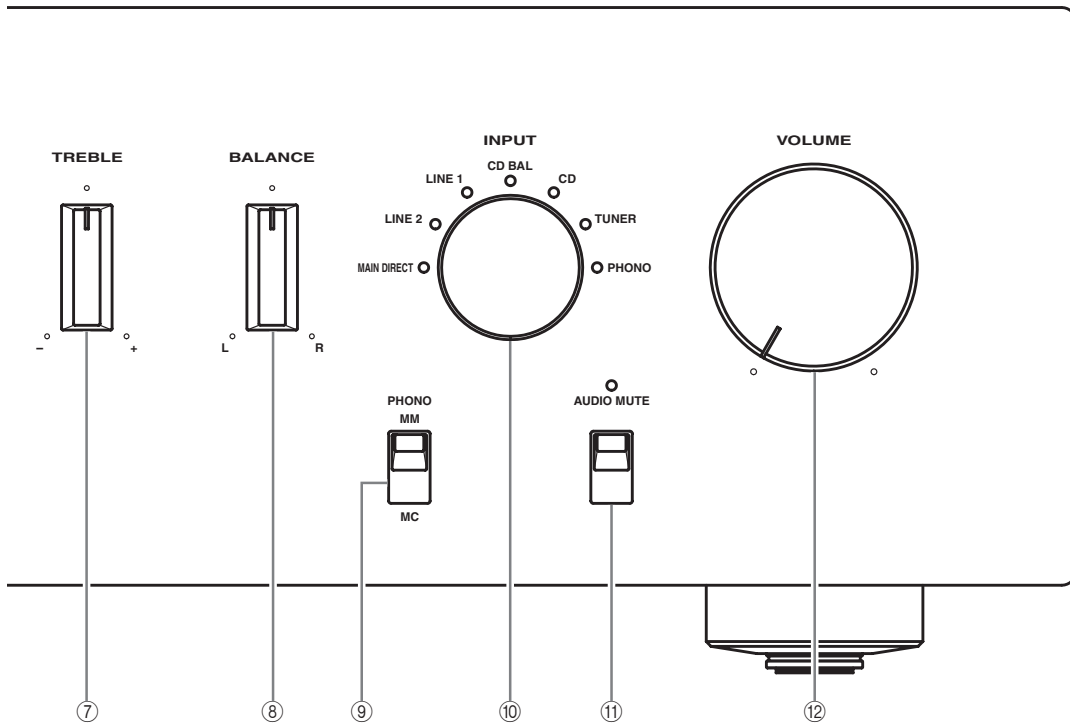

⑩ INPUT selector

Selects the input source you want to listen to. The audio signals of the selected input source are also output at the REC jacks.

Notes

- Switch to the CD BAL position to select the CD player connected to the CD BAL jacks (balanced XLR jacks).
- Switch to the CD position to select the CD player connected to the CD jacks (unbalanced RCA jacks).
- Switch to the MAIN DIRECT position to select the component connected to the MAIN IN jacks. When MAIN DIRECT is selected as the input source, no signals are output at the PRE OUT, REC, and PHONES jacks.

⑪ AUDIO MUTE

Press downward to reduce the current volume level by approximately 20 dB. Press again to restore the audio output to the previous volume level.



- The AUDIO MUTE indicator lights up while the mute function is on.
- You can also rotate VOLUME on the front panel or press VOL +/- on the remote control to resume the audio output.

⑫ VOLUME

Controls the volume level. This does not affect the REC level.

Note

The VOLUME control does not affect when you select MAIN DIRECT as the input source. Adjust the volume level using the volume control on the external amplifier connected to the MAIN DIRECT jacks.

■ Rear panel

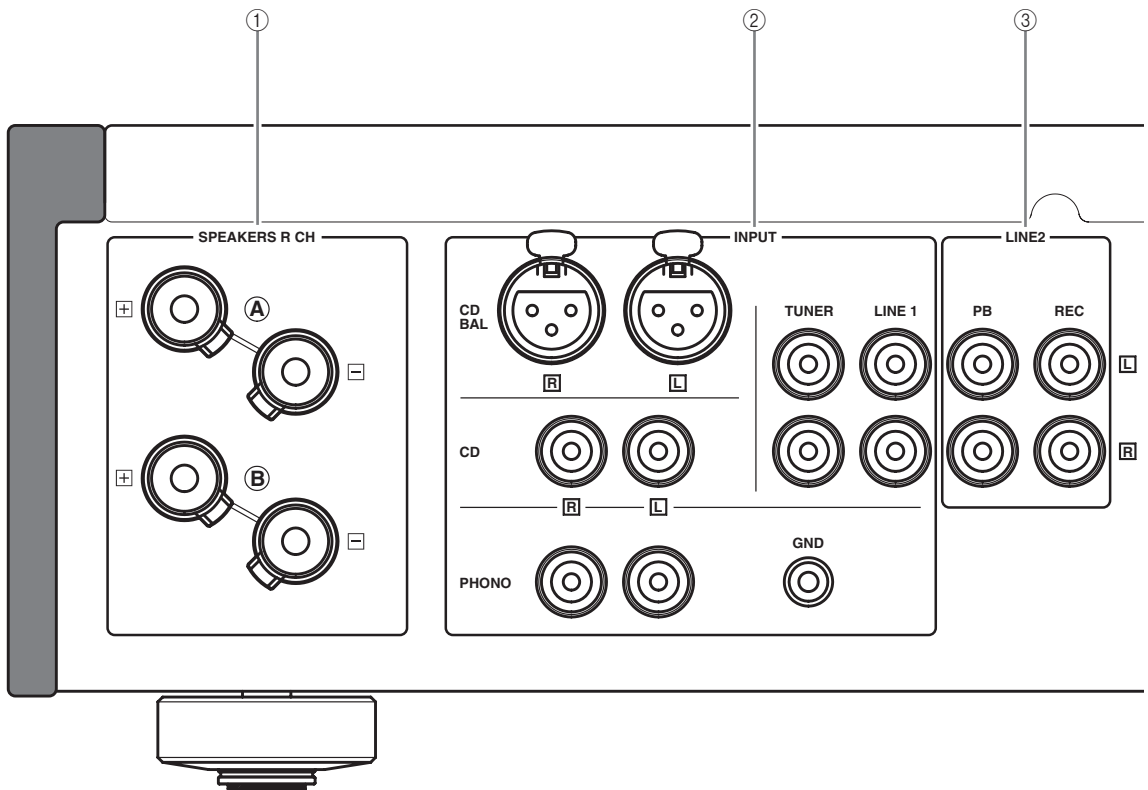

See page 14 for connection information.

① SPEAKERS L/R CH terminals

② INPUT jacks

③ LINE2 jacks

④ MAIN IN jacks

Note

Adjust the volume level using the volume control on the external amplifier connected to the MAIN DIRECT jacks when you select MAIN DIRECT as the input source.

⑤ PRE OUT jacks

Notes

- When you connect audio pin plugs to the PRE OUT jacks to drive the speakers using an external amplifier, it is not necessary to use the SPEAKERS L/R CH terminals.
- The signal output at the PRE OUT jacks are affected by the tone control settings.
- The PRE OUT jacks output the same channel signal as the SPEAKERS L/R CH terminals.
- When you use a subwoofer, connect it to the PRE OUT jacks and speakers to the SPEAKERS L/R CH terminals.

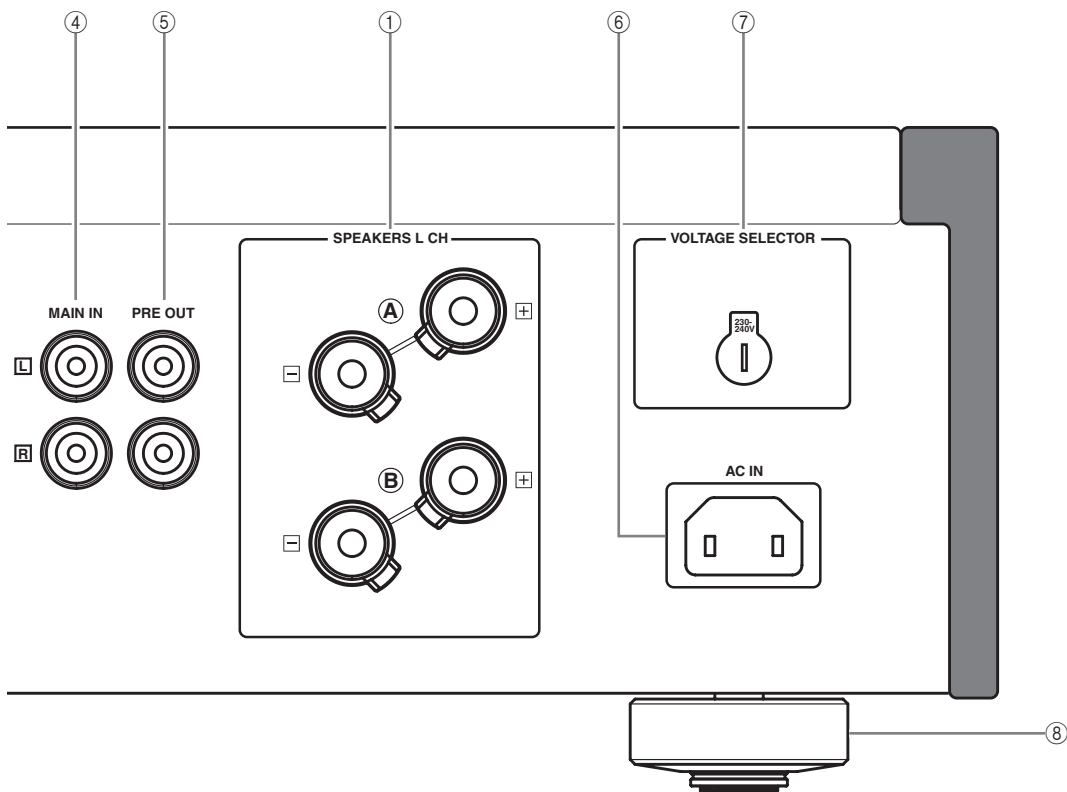

⑥ AC IN

Use this inlet to plug in the supplied power cable.

**⑦ VOLTAGE SELECTOR
(Asia and General models only)**

The **VOLTAGE SELECTOR** on the rear panel of this unit must be set for your local main voltage **BEFORE** plugging the AC power cable into the AC wall outlet. Improper setting of the **VOLTAGE SELECTOR** may cause damage to this unit and create a potential fire hazard.

Rotate the **VOLTAGE SELECTOR** clockwise or counterclockwise to the correct position using a straight slot screwdriver.

Voltages are as follows:

AC 110/120/220/230–240 V, 50/60 Hz

⑧ Foot

The feet of this unit include built-in spikes. Using the spikes can reduce the effect of vibrations on the set. When using the spikes, remove the magnet foot by pulling it.

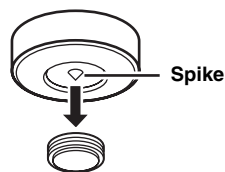

Caution

When using the feet's built-in spikes, the spikes may scratch the shelf or floor on which this unit is installed. Use the supports when placing this unit on expensive furniture, etc.



If this unit is unstable, you can adjust the foot height by rotating it.

Controls and functions

■ Remote control

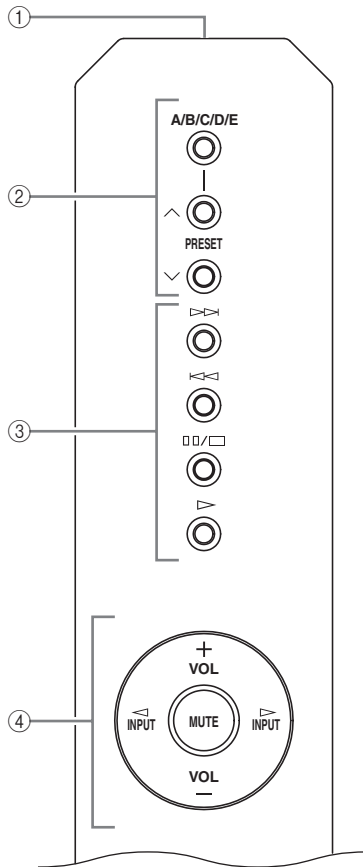

① Infrared signal transmitter

Outputs infrared control signals.

② Yamaha tuner control buttons

Control functions of Yamaha tuner. Refer to the owner's manual of your tuner for details.

Note

Some components may not be controlled by this remote control.

③ Yamaha CD player control buttons

Control various functions of Yamaha CD player. Refer to the owner's manual of your CD player for details.



Press once to pause and twice to stop playback.

Note

Some components may not be controlled by this remote control.

④ Amplifier control buttons

INPUT ◀ / ▶

Selects the input source you want to listen to.

Notes

- When MAIN DIRECT is selected as the input source, no signals are output at the PRE OUT and REC jacks.
- If headphones are plugged into the PHONES jack while MAIN DIRECT is selected as the input source, no audio is output at the PHONES jack.

VOL +/-

Controls the volume level.

Note

The VOLUME control does not affect when you select MAIN DIRECT as the input source. Adjust the volume level using the volume control on the external amplifier connected to the MAIN DIRECT jacks.

MUTE

Reduces the current volume level by approximately 20 dB. Press again to restore the audio output to the previous volume level.



You can also press VOL +/- to resume the audio output.

■ Installing batteries in the remote control

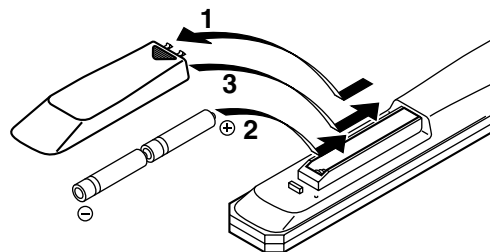

1 Press the ▼ part and slide the battery compartment cover off.

2 Insert the two supplied batteries (AA, R6, UM-3) according to the polarity markings (+ and -) on the inside of the battery compartment.

3 Slide the cover back until it snaps into place.

INPUT

PUSH

- INV.
+ NON INV.

A-S2000 Connections

In this section, you will make connections between A-S2000, speakers, and source components.

TUNER

GND

A-S2000

Connections

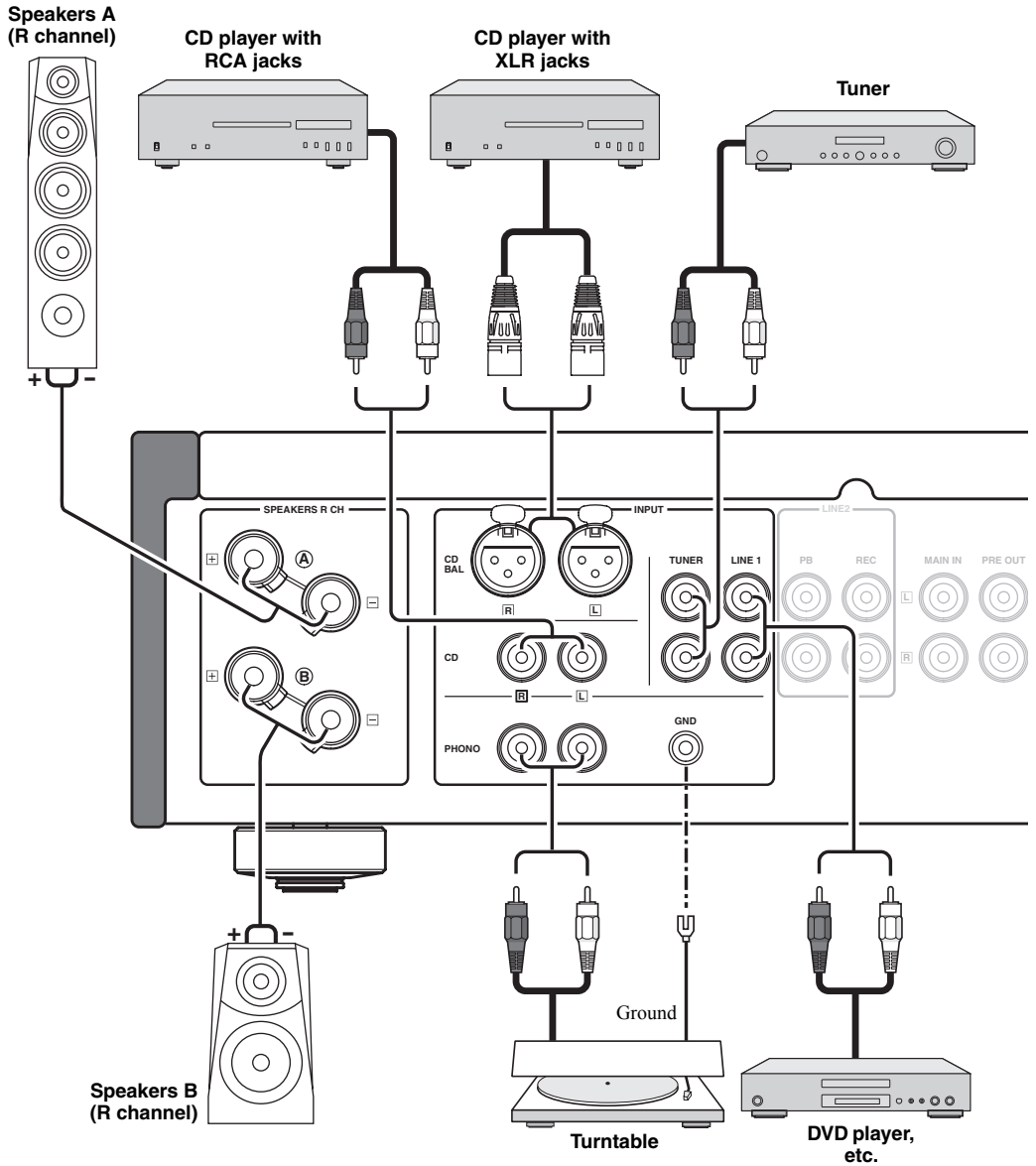

Caution

- Do not let the bare speaker wires touch each other or do not let them touch any metal part of this unit. This could damage this unit and/or the speakers.
- All connections must be correct: L (left) to L, R (right) to R, “+” to “+”, and “-” to “-”. If the connections are faulty, no sound will be heard from the speakers, and if the polarity of the speaker connections is incorrect, the sound will be unnatural and lack bass. Also, refer to the owner’s manual for each of your components.
- Use RCA unbalanced cables to connect other components except speakers. Use “male” XLR balanced cables to connect a CD player with XLR balanced output jacks to the CD BAL jacks of this unit.
- Connect your turntable to the GND terminal to reduce noise in the signal. However, you may hear less noise without the connection to the GND terminal for some record players.

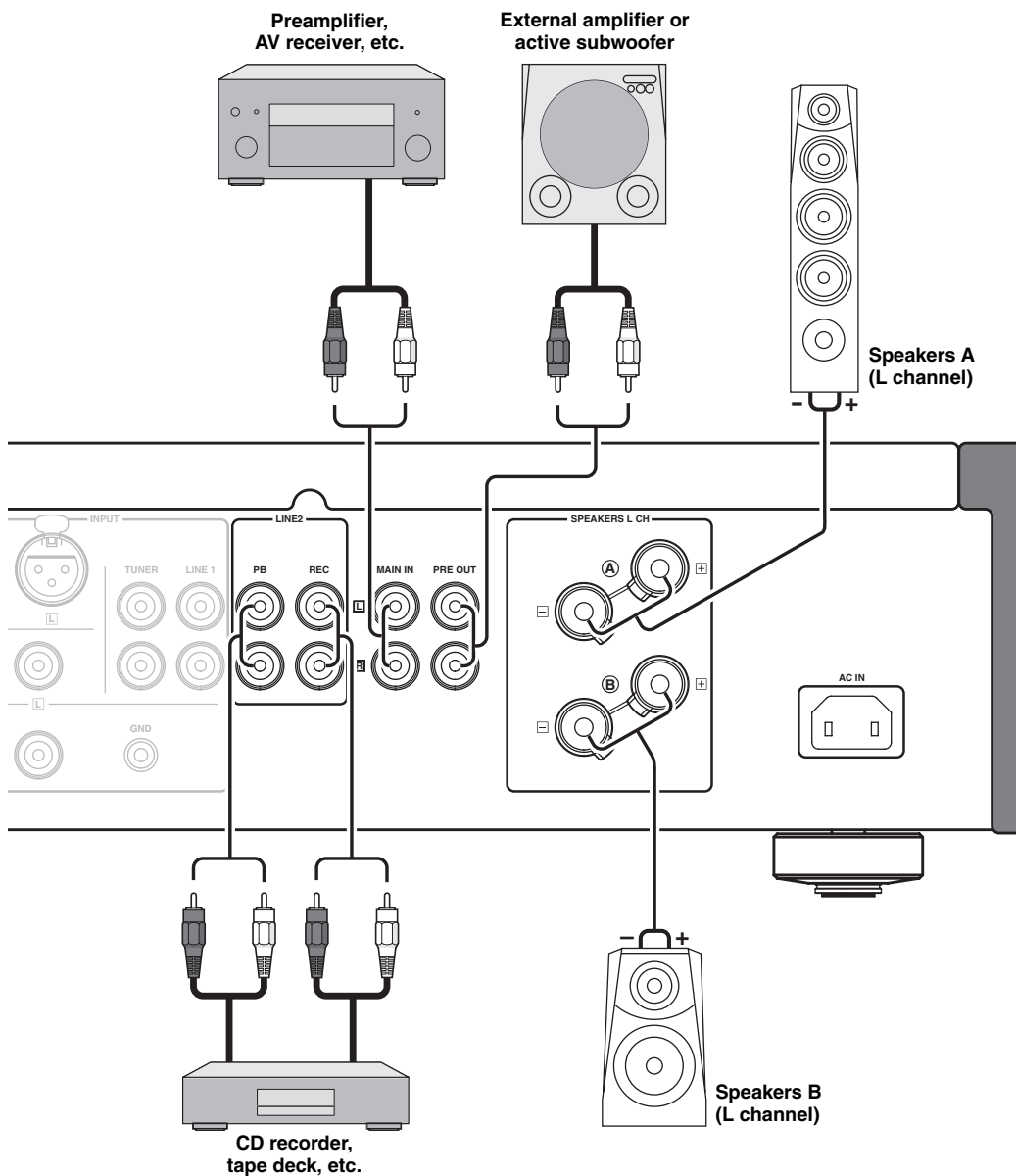

Caution

- Because the power amplifier of A-S2000 is of the floating balanced type, the following types of connections are not possible.
 - Connecting with the left channel “-” terminal and the right channel “+” terminal as well as “+” terminals (Fig. 1).
 - Deliberately connecting with the left/right channel “-” terminals and metal part on the rear panel of this unit, as well as accidentally touching them.
 - Connecting with the left channel “-” terminal and the right channel “-” terminal inverted (cross connection, Fig. 2).
- Do not connect your active subwoofer to the SPEAKERS terminal. Connect it to the PRE OUT jacks of this unit.

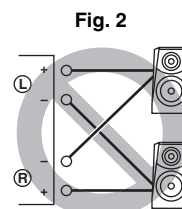
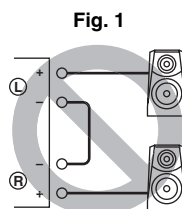

■ **Connecting the speakers**

-
- 1** Remove approximately 10 mm (0.4 in) of insulation from the end of each speaker cable and twist the exposed wires of the cable together to prevent short circuits.

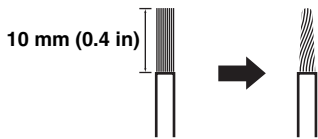

-
- 2** Unscrew the knob and then insert the bare wire into the hole.

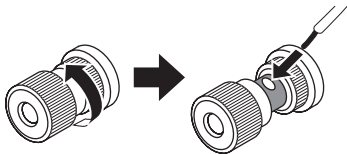

-
- 3** Tighten the knob.



■ **Connecting the banana plug**
(Except for Europe models)

First, tighten the knob and then insert the banana plug into the end of the corresponding terminal.

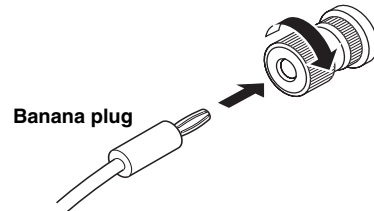

■ **Connecting the Y-shaped lug**

-
- 1** Unscrew the knob and then sandwich the Y-shaped lug between the ring part and base.

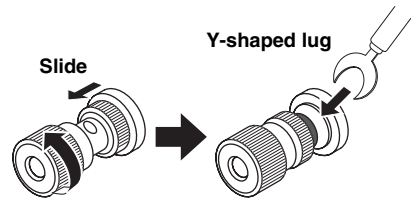

-
- 2** Tighten the knob.

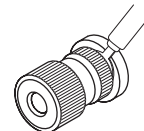

■ Bi-wire connection

The bi-wire connection separates the woofer from the combined midrange and tweeter section. A bi-wire compatible speaker has four binding post terminals. These two sets of terminals allow the speaker to be split into two independent sections. This split connects the mid and high frequency drivers to one set of terminals and the low frequency driver to the other pair.

Caution

To use the bi-wire connections, the impedance of each speaker must be 8 Ω or higher.

Notes

- Remove the shorting bars or bridges to separate the LPF (low pass filter) and HPF (high pass filter) crossovers.
- To use the bi-wire connections, switch the SPEAKERS selector to the A+B BI-WIRING position.

■ Connecting to the CD BAL jacks

Connect your CD player with the XLR balanced output jacks. The pin assignments for these jacks are shown below. Refer to the owner's manual supplied with your CD player and verify that its XLR balanced output jacks are compatible with the pin assignments.

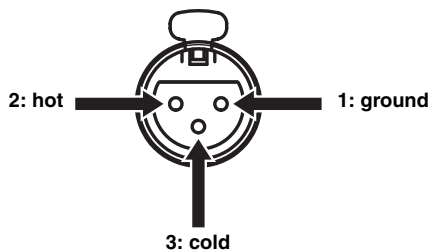

When connecting, be sure to match the pins and insert the connector of the “male” XLR balanced cable until you hear a “click”. When disconnecting, pull out the “male” XLR balanced cable while holding down the lever of the CD BAL jacks.

“Female” XLR connector

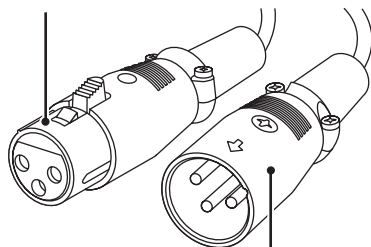

“Male” XLR connector

Note

To use the XLR balanced connection, you must switch the INPUT selector on the front panel to the CD BAL position.

■ **VOLTAGE SELECTOR**
(Asia and General models only)

Caution

The VOLTAGE SELECTOR on the rear panel of this unit must be set for your local voltage BEFORE plugging the power cable into the AC wall outlet. Improper setting of the VOLTAGE SELECTOR may cause damage to this unit and create a potential fire hazard.

Rotate the VOLTAGE SELECTOR clockwise or counterclockwise to the correct position using a straight slot screwdriver.

Voltages are as follows:

..... AC 110/120/220/230–240 V, 50/60 Hz

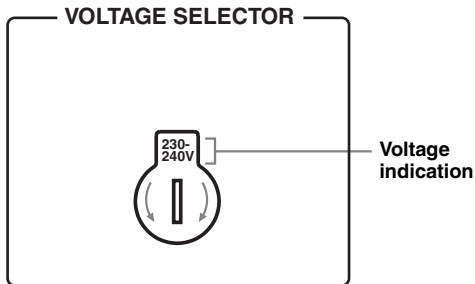

■ **Connecting the power cable**

Plug the power cable into the AC IN connector when all connections are complete, and then plug in the power cable to the AC outlet.



A-S2000 Specifications

In this section, you will find technical specifications for A-S2000.

A-S2000

Specifications

POWER SECTION

- Minimum RMS Output Power
(8 Ω , 20 Hz to 20 kHz, 0.02% THD) 90 W + 90 W
(4 Ω , 20 Hz to 20 kHz, 0.02% THD) 150 W + 150 W
- Dynamic Power (IHF) (8/6/4/2 Ω) 105/135/190/220 W
- Maximum Output Power
(1 kHz, 0.7% THD, 4 Ω) [U.K. and Europe models only]
..... 160 W
- Maximum Useful Output Power (JEITA)
(1 kHz, 10% THD, 8/4 Ω)
[Asia, General, China and Korea models only] 120/190 W
- Dynamic Headroom
8 Ω 0.67 dB
- IEC Output Power [U.K. and Europe models only]
(1 kHz, 0.02% THD, 8/4 Ω)..... 95/155 W
- Damping Factor
1 kHz, 8 Ω 160
- Maximum Input Signal
CD, etc. 2.8 V
PHONO MM (1 kHz) 120 mV
PHONO MC (1 kHz) 7 mV
- Frequency Response
CD, etc. (Flat Position, 5 Hz to 100 kHz) +0/-3 dB
CD, etc. (Flat Position, 20 Hz to 20 kHz) +0/-0.3 dB
- RIAA Equalization Deviation
PHONO MM (20 Hz to 20 kHz) ±0.5 dB
PHONO MC (20 Hz to 20 kHz) ±0.5 dB
- Total Harmonic Distortion
CD BAL to SP OUT
(20 Hz to 20 kHz, 90 W/8 Ω) 0.01%
CD, etc. to SP OUT
(20 Hz to 20 kHz, 90 W/8 Ω) 0.015%
PHONO MM to REC
(20 Hz to 20 kHz, 2 V) 0.005%
PHONO MC to REC
(20 Hz to 20 kHz, 2 V) 0.05%
- Intermodulation Distortion
CD, etc. to SP OUT
(Rated output/8 Ω) 0.02%
- Signal to Noise Ratio (IHF-A Network)
CD, etc. (150 mV, Input shorted) 98 dB
PHONO MM (5 mV, Input shorted) 93 dB
PHONO MC (500 μV, Input shorted) 85 dB
- Residual Noise (IHF-A Network) (CD, etc.) 33 μV

CONTROL SECTION

- Input Sensitivity/Input Impedance
CD, etc. 150 mV/47 kΩ
MM 2.5 mV/47 kΩ
MC 100 μV/50 Ω
MAIN IN 1 V/47 kΩ
- Output Level/Output Impedance
REC OUT 150 mV/1.5 kΩ
PRE OUT 1 V/1.5 kΩ
- Headphone Rated Output
1 kHz, 32 Ω , 0.2% THD 30 mW
- Channel Separation
CD, etc. (5.1 kΩ Terminated, 1 kHz/10 kHz) 74/54 dB
PHONO MM (Input shorted, 1 kHz/10 kHz, Vol.:-30 dB)
..... 90/77 dB
PHONO MC (Input shorted, 1 kHz/10 kHz, Vol.:-30 dB)
..... 66/77 dB
- Tone Control Characteristics
BASS
Boost/Cut (50 Hz) ±9 dB
Turnover Frequency 350 Hz
TREBLE
Boost/Cut (20 kHz) ±9 dB
Turnover Frequency 3.5 kHz
- Audio muting -20 dB (approx.)

GENERAL

- Power Supply
[U.S.A. and Canada models] AC 120 V, 60 Hz
[Asia model] AC 220/230-240 V, 50/60 Hz
[General model] AC 110/120/220/230-240 V, 50/60 Hz
[China model] AC 220 V, 50 Hz
[Korea model] AC 220 V, 60 Hz
[Australia model] AC 240 V, 50 Hz
[U.K. and Europe models] AC 230 V, 50 Hz
- Power consumption 350 W
- Idling power consumption 80 W
- Off-state power consumption 0 W
- Dimensions (W x H x D) 435 x 137 x 465 mm
(17-1/8" x 5-3/8" x 18-5/16")
- Weight 22.7 kg (50 lbs.)

* Specifications are subject to change without notice.

■ Block diagram

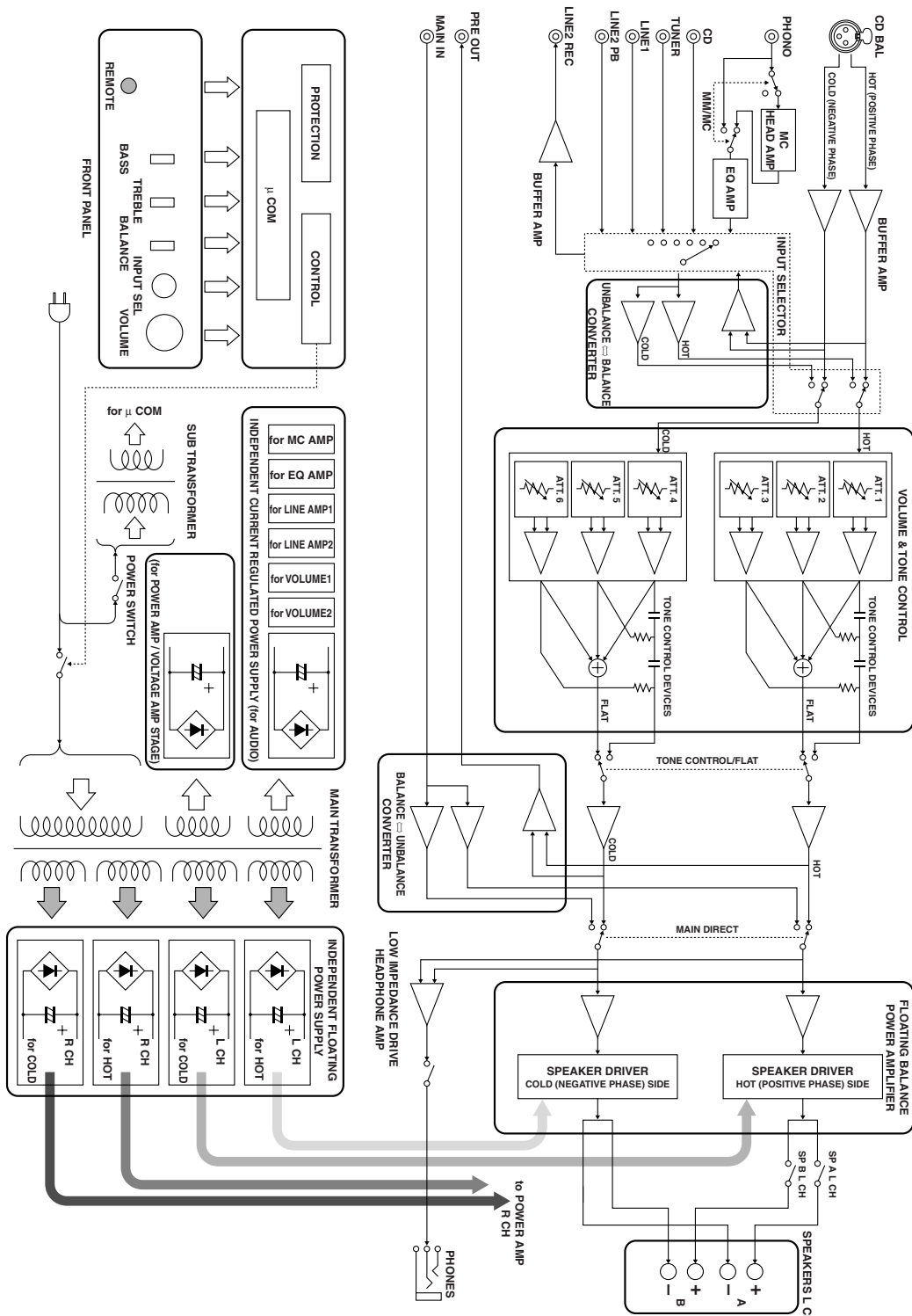

■ Tone control characteristics

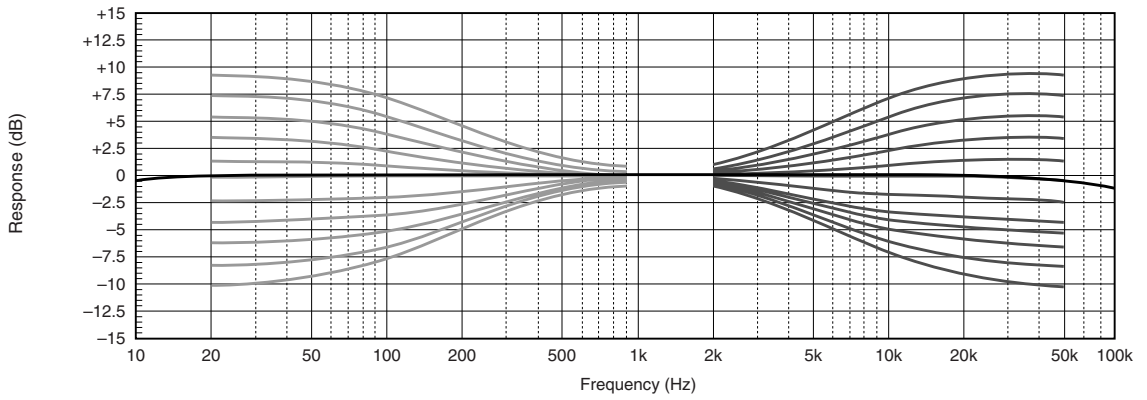

■ Total harmonic distortion

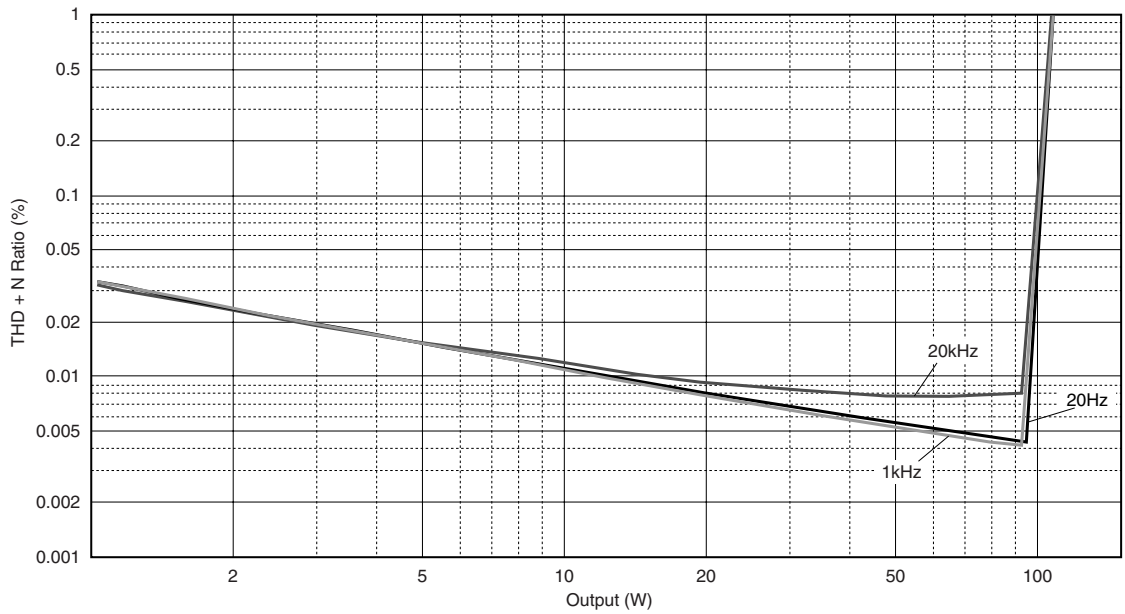

■ Total harmonic distortion (PHONO)

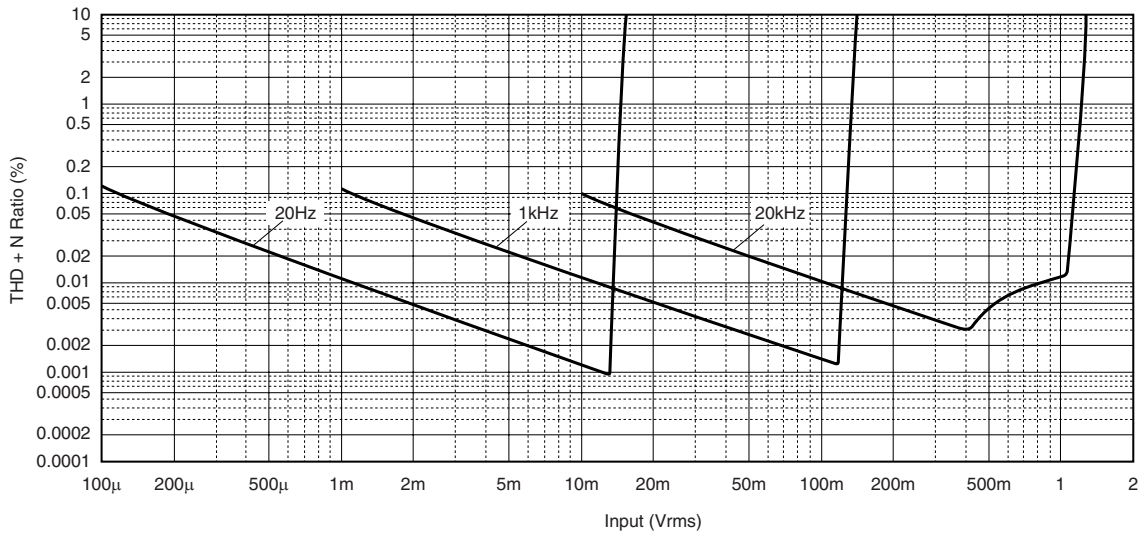

Refer to the chart below if this unit does not function properly. If the problem you are experiencing is not listed below or if the instructions below do not help, turn off this unit, disconnect the AC power cable, and contact the nearest authorized Yamaha dealer or service center.

Problem	Cause	Remedy	See page
This unit fails to turn on.	The AC power cable is not connected to the AC IN inlet on the rear panel or not plugged in the AC wall outlet.	Connect the AC power cable firmly.	18
	The protection circuitry has been activated because of a short circuit, etc.	Check that the speaker wires are not touching each other or shorting out against the rear panel of this unit, and then turn the power of this unit back on.	14
	This unit has been exposed to a strong external electric shock (such as lightning or strong static electricity).	Turn off this unit, disconnect the AC power cable, plug it back in after 30 seconds, and then use it normally.	—
The POWER indicator on the front panel flashes.	The protection circuitry has been activated because of a short circuit, etc.	Check that the speaker wires are not touching each other or shorting out against the rear panel of this unit, and then turn the power of this unit back on.	14
	There is a problem with the internal circuitries of this unit.	Disconnect the AC power cable and contact the nearest authorized Yamaha dealer or service center.	—
The INPUT indicator on the front panel flashes and the volume is turned down when you turn on this unit.	The protection circuitry has been activated because of a short circuit, etc.	Check that the speaker wires are not touching each other or shorting out against the rear panel of this unit, and then turn the power of this unit back on.	14
No sound.	Incorrect input or output cable connections.	Connect the cables properly. If the problem persists, the cables may be defective.	14
	No appropriate input source has been selected.	Select an appropriate input source with the INPUT selector on the front panel (or one of the input selector buttons on the remote control).	—
	The SPEAKERS switch is not set properly.	Switch the SPEAKERS switch to the appropriate position.	—
	Speaker connections are not secure.	Secure the connections.	14
The sound suddenly goes off.	The protection circuitry has been activated because of a short circuit, etc.	Check that the speaker wires are not touching each other or shorting out against the rear panel of this unit, and then turn the power of this unit back on.	14
Only the speaker on one side can be heard.	Incorrect cable connections.	Connect the cables properly. If the problem persists, the cables may be defective.	14
	Incorrect setting for the BALANCE control.	Set the BALANCE control to the appropriate position.	—
There is a lack of bass and no ambience.	The + and – wires are connected in reverse at the amplifier or the speakers.	Connect the speaker wires to the correct + and – phase.	14
A “humming” sound is heard.	Incorrect cable connections.	Connect the audio cable plugs firmly. If the problem persists, the cables may be defective.	14
	No connection from the turntable to the GND terminal.	Connect the turntable to the GND terminal of this unit.	14

Problem	Cause	Remedy	See page
The volume level is low while playing a record.	Incorrect setting for the PHONO switch on the front panel.	Switch the PHONO switch to the MM or MC position according to the type of magnetic cartridge of the turntable.	—
The sound is degraded when listening with the headphones connected to the CD player connected to this unit.	The power of this unit is turned off.	Turn on the power of this unit.	—
The remote control does not work or function properly.	Wrong distance or angle.	The remote control functions within a maximum range of 6 m (20 ft) and no more than 30 degrees off-axis from the front panel.	6
	Direct sunlight or lighting (from an inverter type of fluorescent lamp, etc.) is striking the remote control sensor of this unit.	Reposition this unit.	—
	The batteries are weak.	Replace all batteries.	12

Taking care of this unit

When you wipe this unit, do not use chemical solvents (ex. alcohol or thinner etc.); this might damage the finish. Use a clean, dry cloth. For heavy dirt, dampen a soft cloth in detergent diluted with the water, wring it out, and then clean this unit up with the cloth.

The screws on the side panels may loosen as wood expands and contracts. In this case, tighten the screws.



© 2007 YAMAHA CORPORATION All rights reserved.

YAMAHA ELECTRONICS CORPORATION, USA 6660 ORANGETHORPE AVE., BUENA PARK, CALIF. 90620, U.S.A.
YAMAHA CANADA MUSIC LTD. 135 MILNER AVE., SCARBOROUGH, ONTARIO M1S 3R1, CANADA
YAMAHA ELECTRONIK EUROPA G.m.b.H. SIEMENSSTR. 22-34, 25462 RELLINGEN BEI HAMBURG, GERMANY
YAMAHA ELECTRONIQUE FRANCE S.A. RUE AMBROISE CROIZAT BP70 CROISSY-BEAUBOURG 77312 MARNE-LA-VALLEE CEDEX02, FRANCE
YAMAHA ELECTRONICS (UK) LTD. YAMAHA HOUSE, 200 RICKMANSWORTH ROAD WATFORD, HERTS WD18 7GQ, ENGLAND
YAMAHA SCANDINAVIA A.B. J A WETTERGRENS GATA 1, BOX 30053, 400 43 VÄSTRA FRÖLUNDA, SWEDEN
YAMAHA MUSIC AUSTRALIA PTY, LTD. 17-33 MARKET ST., SOUTH MELBOURNE, 3205 VIC., AUSTRALIA



YAMAHA CORPORATION
Printed in Malaysia  WM15590

A-S2000

Stereo amplifler

Amplificateur Stéréo

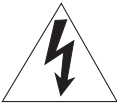
IMPORTANT SAFETY INSTRUCTIONS

	CAUTION RISK OF ELECTRIC SHOCK DO NOT OPEN	
<p>CAUTION: TO REDUCE THE RISK OF ELECTRIC SHOCK, DO NOT REMOVE COVER (OR BACK). NO USER-SERVICEABLE PARTS INSIDE. REFER SERVICING TO QUALIFIED SERVICE PERSONNEL.</p>		

• Explanation of Graphical Symbols



The lightning flash with arrowhead symbol, within an equilateral triangle, is intended to alert you to the presence of uninsulated “dangerous voltage” within the product’s enclosure that may be of sufficient magnitude to constitute a risk of electric shock to persons.



The exclamation point within an equilateral triangle is intended to alert you to the presence of important operating and maintenance (servicing) instructions in the literature accompanying the appliance.

IMPORTANT

Please record the serial number of this unit in the space below.

MODEL:
Serial No.:

The serial number is located on the rear of the unit. Retain this Owner’s Manual in a safe place for future reference.

FOR CANADIAN CUSTOMERS

To prevent electric shock, match wide blade of plug to wide slot and fully insert.

This Class B digital apparatus complies with Canadian ICES-003.

- 1 Read these instructions.
- 2 Keep these instructions.
- 3 Heed all warnings.
- 4 Follow all instructions.
- 5 Do not use this apparatus near water.
- 6 Clean only with dry cloth.
- 7 Do not block any ventilation openings. Install in accordance with the manufacturer’s instructions.
- 8 Do not install near any heat sources such as radiators, heat registers, stoves, or other apparatus (including amplifiers) that produce heat.
- 9 Do not defeat the safety purpose of the polarized or grounding-type plug. A polarized plug has two blades with one wider than the other. A grounding type plug has two blades and a third grounding prong. The wide blade or the third prong are provided for your safety. If the provided plug does not fit into your outlet, consult an electrician for replacement of the obsolete outlet.
- 10 Protect the power cord from being walked on or pinched particularly at plugs, convenience receptacles, and the point where they exit from the apparatus.
- 11 Only use attachments/accessories specified by the manufacturer.
- 12 Use only with the cart, stand, tripod, bracket, or table specified by the manufacturer, or sold with the apparatus. When a cart is used, use caution when moving the cart/apparatus combination to avoid injury from tip-over.
- 13 Unplug this apparatus during lightning storms or when unused for long periods of time.
- 14 Refer all servicing to qualified service personnel. Servicing is required when the apparatus has been damaged in any way, such as power-supply cord or plug is damaged, liquid has been spilled or objects have fallen into the apparatus, the apparatus has been exposed to rain or moisture, does not operate normally, or has been dropped.



We Want You Listening For A Lifetime

Yamaha and the Electronic Industries Association’s Consumer Electronics Group want you to get the most out of your equipment by playing it at a safe level. One that lets the sound come through loud and clear without annoying blaring or distortion – and, most importantly, without affecting your sensitive hearing. Since hearing damage from loud sounds is often undetectable until it is too late, Yamaha and the Electronic Industries Association’s Consumer Electronics Group recommend you to avoid prolonged exposure from excessive volume levels.



FCC INFORMATION (for US customers)

1 **IMPORTANT NOTICE: DO NOT MODIFY THIS UNIT!**

This product, when installed as indicated in the instructions contained in this manual, meets FCC requirements. Modifications not expressly approved by Yamaha may void your authority, granted by the FCC, to use the product.

2 **IMPORTANT:** When connecting this product to accessories and/or another product use only high quality shielded cables. Cable/s supplied with this product **MUST** be used. Follow all installation instructions. Failure to follow instructions could void your FCC authorization to use this product in the USA.

3 **NOTE:** This product has been tested and found to comply with the requirements listed in FCC Regulations, Part 15 for Class "B" digital devices. Compliance with these requirements provides a reasonable level of assurance that your use of this product in a residential environment will not result in harmful interference with other electronic devices.

This equipment generates/uses radio frequencies and, if not installed and used according to the instructions found in the users manual, may cause interference harmful to the operation of other electronic devices.

Compliance with FCC regulations does not guarantee that interference will not occur in all installations. If this product is found to be the source of interference, which can be determined by turning the unit "OFF" and "ON", please try to eliminate the problem by using one of the following measures:

Relocate either this product or the device that is being affected by the interference.

Utilize power outlets that are on different branch (circuit breaker or fuse) circuits or install AC line filter/s.

In the case of radio or TV interference, relocate/reorient the antenna. If the antenna lead-in is 300 ohm ribbon lead, change the lead-in to coaxial type cable.

If these corrective measures do not produce satisfactory results, please contact the local retailer authorized to distribute this type of product. If you can not locate the appropriate retailer, please contact Yamaha Electronics Corp., U.S.A. 6660 Orangethorpe Ave., Buena Park, CA 90620.

The above statements apply **ONLY** to those products distributed by Yamaha Corporation of America or its subsidiaries.

■ For U.K. customers

If the socket outlets in the home are not suitable for the plug supplied with this appliance, it should be cut off and an appropriate 3 pin plug fitted. For details, refer to the instructions described below.

Note

The plug severed from the mains lead must be destroyed, as a plug with bared flexible cord is hazardous if engaged in a live socket outlet.

■ Special Instructions for U.K. Model

IMPORTANT

THE WIRES IN MAINS LEAD ARE COLOURED IN ACCORDANCE WITH THE FOLLOWING CODE:

Blue: NEUTRAL

Brown: LIVE

As the colours of the wires in the mains lead of this apparatus may not correspond with the coloured markings identifying the terminals in your plug, proceed as follows:

The wire which is coloured BLUE must be connected to the terminal which is marked with the letter N or coloured BLACK. The wire which is coloured BROWN must be connected to the terminal which is marked with the letter L or coloured RED.

Making sure that neither core is connected to the earth terminal of the three pin plug.

Caution: Read this before operating your unit.

- 1 To assure the finest performance, please read this manual carefully. Keep it in a safe place for future reference.
- 2 Install this sound system in a well ventilated, cool, dry, clean place – away from direct sunlight, heat sources, vibration, dust, moisture, and/or cold. Allow ventilation space of at least 30 cm on the top, 20 cm on the left and right, and 20 cm on the back of this unit.
- 3 Locate this unit away from other electrical appliances, motors, or transformers to avoid humming sounds.
- 4 Do not expose this unit to sudden temperature changes from cold to hot, and do not locate this unit in an environment with high humidity (i.e. a room with a humidifier) to prevent condensation inside this unit, which may cause an electrical shock, fire, damage to this unit, and/or personal injury.
- 5 Avoid installing this unit where foreign objects may fall onto this unit and/or this unit may be exposed to liquid dripping or splashing. On the top of this unit, do not place:
 - Other components, as they may cause damage and/or discoloration on the surface of this unit.
 - Burning objects (i.e. candles), as they may cause fire, damage to this unit, and/or personal injury.
 - Containers with liquid in them, as they may fall and liquid may cause electrical shock to the user and/or damage to this unit.
- 6 Do not cover this unit with a newspaper, tablecloth, curtain, etc. in order not to obstruct heat radiation. If the temperature inside this unit rises, it may cause fire, damage to this unit, and/or personal injury.
- 7 Do not plug in this unit to a wall outlet until all connections are complete.
- 8 Do not operate this unit upside-down. It may overheat, possibly causing damage.
- 9 Do not use force on switches, knobs and/or cords.
- 10 When disconnecting the power cable from the wall outlet, grasp the plug; do not pull the cable.
- 11 Do not clean this unit with chemical solvents; this might damage the finish.
- 12 Only voltage specified on this unit must be used. Using this unit with a higher voltage than specified is dangerous and may cause fire, damage to this unit, and/or personal injury. Yamaha will not be held responsible for any damage resulting from use of this unit with a voltage other than specified.
- 13 To prevent damage by lightning, keep the power cord disconnected from a wall outlet or the unit during a lightning storm.
- 14 Do not attempt to modify or fix this unit. Contact qualified Yamaha service personnel when any service is needed. The cabinet should never be opened for any reasons.
- 15 When not planning to use this unit for long periods of time (i.e. vacation), disconnect the AC power plug from the wall outlet.
- 16 Install this unit near the AC outlet and where the AC power plug can be reached easily.
- 17 Be sure to read the “Troubleshooting” section in the owner’s manual on common operating errors before concluding that this unit is faulty.
- 18 Before moving this unit, press POWER downward to turn off this unit and then disconnect the AC power plug from the AC wall outlet.
- 19 **VOLTAGE SELECTOR** (Asia and General models only)
The VOLTAGE SELECTOR on the rear panel of this unit must be set for your local main voltage BEFORE plugging into the AC wall outlet. Voltages are:
.....AC 110/120/220/230–240 V, 50/60 Hz
- 20 The batteries shall not be exposed to excessive heat such as sunshine, fire or like.
- 21 Excessive sound pressure from earphones and headphones can cause hearing loss.

As long as this unit is connected to the AC wall outlet, it is not disconnected from the AC power source even if you turn off this unit by POWER.

WARNING
TO REDUCE THE RISK OF FIRE OR ELECTRIC SHOCK, DO NOT EXPOSE THIS UNIT TO RAIN OR MOISTURE.



This symbol mark is according to the EU directive 2002/96/EC.

This symbol mark means that electrical and electronic equipment, at their end-of-life, should be disposed of separately from your household waste.

Please act according to your local rules and do not dispose of your old products with your normal household waste.

■ Notes on batteries

- Change all of the batteries if you notice that the operation range of the remote control decreases.
- Use AA, R6, UM-3 batteries.
- Make sure that the polarities are correct. See the illustration inside the battery compartment.
- Remove the batteries if the remote control is not used for an extended period of time.
- Do not use old batteries together with new ones.
- Do not use different types of batteries (such as alkaline and manganese batteries) together. Read the packaging carefully as these different types of batteries may have the same shape and color.
- If the batteries have leaked, dispose of them immediately. Avoid touching the leaked material or letting it come into contact with clothing, etc. Clean the battery compartment thoroughly before installing new batteries.
- Do not throw away batteries with general house waste; dispose of them correctly in accordance with your local regulations.

■ Handling the remote control

- The area between the remote control and this unit must be clear of large obstacles.
- Do not spill water or other liquids on the remote control.
- Do not drop the remote control.
- Do not leave or store the remote control in the following types of conditions:
 - places of high humidity, such as near a bath
 - places of high temperature, such as near a heater or a stove
 - places of extremely low temperatures
 - dusty places
- Do not expose the remote control sensor to strong lighting, in particular, an inverter type fluorescent lamp; otherwise, the remote control may not work properly. If necessary, position this unit away from direct lighting.

Limited Guarantee for European Economic Area (EEA) and Switzerland

Thank you for having chosen a Yamaha product. In the unlikely event that your Yamaha product needs guarantee service, please contact the dealer from whom it was purchased. If you experience any difficulty, please contact Yamaha representative office in your country. You can find full details on our website (<http://www.yamaha-hifi.com/> or <http://www.yamaha-uk.com/> for U.K. resident).

The product is guaranteed to be free from defects in workmanship or materials for a period of two years from the date of the original purchase. Yamaha undertakes, subject to the conditions listed below, to have the faulty product or any part(s) repaired, or replaced at Yamaha's discretion, without any charge for parts or labour. Yamaha reserves the right to replace a product with that of a similar kind and/or value and condition, where a model has been discontinued or is considered uneconomic to repair.

Conditions

1. The original invoice or sales receipt (showing date of purchase, product code and dealer's name) MUST accompany the defective product, along with a statement detailing the fault. In the absence of this clear proof of purchase, Yamaha reserves the right to refuse to provide free of charge service and the product may be returned at the customer's expense.
2. The product MUST have been purchased from an AUTHORISED Yamaha dealer within the European Economic Area (EEA) or Switzerland.
3. The product must not have been the subject of any modifications or alterations, unless authorised in writing by Yamaha.
4. The following are excluded from this guarantee:
 - a. Periodic maintenance and repair or replacement of parts due to normal wear and tear.
 - b. Damage resulting from:
 - (1) Repairs performed by the customer himself or by an unauthorised third party.
 - (2) Inadequate packaging or mishandling, when the product is in transit from the customer. Please note that it is the customer's responsibility to ensure the product is adequately packaged when returning the product for repair.
 - (3) Misuse, including but not limited to (a) failure to use the product for its normal purpose or in accordance with Yamaha's instructions on the proper use, maintenance and storage, and (b) installation or use of the product in a manner inconsistent with the technical or safety standards in force in the country where it is used.
 - (4) Accidents, lightning, water, fire, improper ventilation, battery leakage or any cause beyond Yamaha's control.
 - (5) Defects of the system into which this product is incorporated and/or incompatibility with third party products.
 - (6) Use of a product imported into the EEA and/or Switzerland, not by Yamaha, where that product does not conform to the technical or safety standards of the country of use and/or to the standard specification of a product sold by Yamaha in the EEA and/or Switzerland.
 - (7) Non AV (Audio Visual) related products.
(Products subject to "Yamaha AV Guarantee Statement" are defined in our website at <http://www.yamaha-hifi.com/> or <http://www.yamaha-uk.com/> for U.K. resident.)
5. Where the guarantee differs between the country of purchase and the country of use of the product, the guarantee of the country of use shall apply.
6. Yamaha may not be held responsible for any losses or damages, whether direct, consequential or otherwise, save for the repair or replacement of the product.
7. Please backup any custom settings or data, as Yamaha may not be held responsible for any alteration or loss to such settings or data.
8. This guarantee does not affect the consumer's statutory rights under applicable national laws in force or the consumer's rights against the dealer arising from their sales/purchase contract.



© 2007 YAMAHA CORPORATION All rights reserved.

YAMAHA ELECTRONICS CORPORATION, USA 6660 ORANGETHORPE AVE., BUENA PARK, CALIF. 90620, U.S.A.
YAMAHA CANADA MUSIC LTD. 135 MILNER AVE., SCARBOROUGH, ONTARIO M1S 3R1, CANADA
YAMAHA ELECTRONIK EUROPA G.m.b.H. SIEMENSSTR. 22-34, 25462 RELLINGEN BEI HAMBURG, GERMANY
YAMAHA ELECTRONIQUE FRANCE S.A. RUE AMBROISE CROIZAT BP70 CROISSY-BEAUBOURG 77312 MARNE-LA-VALLEE CEDEX02, FRANCE
YAMAHA ELECTRONICS (UK) LTD. YAMAHA HOUSE, 200 RICKMANSWORTH ROAD WATFORD, HERTS WD18 7GQ, ENGLAND
YAMAHA SCANDINAVIA A.B. J A WETTERGRENS GATA 1, BOX 30053, 400 43 VÄSTRA FRÖLUNDA, SWEDEN
YAMAHA MUSIC AUSTRALIA PTY, LTD. 17-33 MARKET ST., SOUTH MELBOURNE, 3205 VIC., AUSTRALIA

YAMAHA CORPORATION
Printed in Malaysia ◀ WM15640

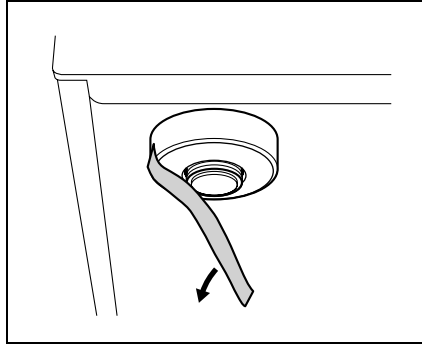
Note on transport tape
English

Upon shipment from the factory, magnet feet are fixed with transport tape to this unit's feet. Remove the transport tape before placing this unit.

Remarque sur le ruban adhésif
Français

Les pieds aimantés ont été fixés en usine aux pieds de cet appareil avec du ruban adhésif. Retirez le ruban adhésif avant d'installer cet appareil.

Hinweis zum Transportband
Deutsch

Bei Versand ab Werk sind die Magnetfüße mit Transportband an den Füßen des Geräts befestigt. Entfernen Sie das Transportband vor der Aufstellung des Geräts.

Anmärkning angående transporttejp
Svenska

Magnetfötterna fixeras med transporttejp på förstärkarens fötter före leverans från fabriken. Avlägsna transporttejpen före placering av förstärkaren.

Note sul nastro adesivo per il trasporto
Italiano

Al momento della spedizione dalla fabbrica, i piedini magnetici vengono fissati al loro posto con nastro adesivo per il trasporto ai piedini di questa unità. Prima di installare questa unità, non dimenticare di togliere il nastro adesivo per il trasporto.

Nota acerca de la cinta de transporte
Español

Al salir la unidad de la fabrica, las patas magnéticas están fijadas con cinta de transporte a las patas de esta unidad. Quite la cinta de transporte antes de instalar esta unidad.

Opmerking over het plakband voor het vervoer
Nederlands

In de fabriek zijn de magnetische voetjes met plakband vastgezet aan de voetjes van het toestel. Verwijder dit plakband voor u het toestel neerzet.

Примечание по транспортировочной ленте
Русский

При отгрузке с завода-изготовителя, с помощью транспортировочной ленты, к ножкам данного аппарата прикрепляются магнитные ножки. Перед размещением данного аппарата, снимите транспортировочную ленту.

运输固定胶带的注意事项
中文

出厂时，磁体脚被运输固定用的胶带固定在本机上。在设置之前，请去除运输固定用的胶带。

운송 테이프에 대한 주의사항
한국어

본 기기 발판에는 마그넷 피트가 있는 운송 테이프가 부착되어 있습니다. 본 기기를 설치하기 전에 운송 테이프를 제거하십시오.

輸送用テープの取り外し
日本語

工場出荷時には、スパイクカバーが本機の脚に輸送用テープで固定されています。設置される前に、輸送用テープを取り外してください。