



AV Receiver

**RX-V3083**

**RX-V2083**

**Owner's Manual**

musicCast

- 
- This unit is a product for enjoying video and music at home.
  - This manual explains preparations and operations for everyday users of the unit.
  - Read the supplied booklet “Quick Start Guide” before using the unit.

# CONTENTS

<b>Introduction</b>	<b>5</b>	<b>3 Connecting the radio antennas</b>	<b>48</b>
<b>Accessories</b>	<b>5</b>	FM/AM antennas (China model only)	48
<b>About this book</b>	<b>5</b>	DAB/FM antenna (Australia model only)	49
<b>About remote control</b>	<b>6</b>	<b>4 Connecting a network cable or preparing the wireless antenna</b>	<b>50</b>
Batteries	6	Connecting the network cable	50
Operating range of the remote control	6	Preparing the wireless antenna	50
<b>FEATURES</b>	<b>7</b>	<b>5 Connecting other devices</b>	<b>51</b>
<b>What you can do with the unit</b>	<b>7</b>	Connecting a device compatible with the trigger function	51
AV CONTROLLER	12	<b>6 Connecting the power cable</b>	<b>51</b>
AV SETUP GUIDE (for tablet)	12	<b>7 Selecting an on-screen menu language</b>	<b>52</b>
MusicCast CONTROLLER	12	<b>8 Configuring the necessary speaker settings</b>	<b>53</b>
<b>Part names and functions</b>	<b>13</b>	<b>9 Optimizing the speaker settings automatically (YPAO)</b>	<b>54</b>
Front panel	13	Multi Position	56
Front display (indicators)	15	Angle/Height	57
Rear panel	16	Measuring at one listening position (single measure)	57
Remote control	18	Measuring at multiple listening positions (multi measure)	60
<b>PREPARATIONS</b>	<b>19</b>	Checking the measurement results	63
<b>General setup procedure</b>	<b>19</b>	Reloading the previous YPAO adjustments	63
<b>1 Connecting speakers</b>	<b>20</b>	Error messages	64
Basic speaker configuration	21	Warning messages	65
Advanced speaker configuration	30	<b>10 Connecting to a network device wirelessly</b>	<b>66</b>
<b>2 Connecting a TV and playback devices</b>	<b>41</b>	Selecting the connection method	66
Input/output jacks and cables	41	Connecting the unit to a wireless network	67
Connecting a TV	43	Connecting a mobile device to the unit directly (Wireless Direct)	72
Connecting video devices (such as BD/DVD players)	44	<b>11 Connecting to the MusicCast network</b>	<b>74</b>
Connecting audio devices (such as CD players)	46	MusicCast CONTROLLER	74
Connecting to the jacks on the front panel	47	Adding the unit to the MusicCast network	74

# PLAYBACK 75

<b>Basic playback procedure</b> .....	<b>75</b>
Selecting an HDMI output jack .....	75
<b>Selecting the input source and favorite settings with one touch (SCENE)</b> .....	<b>76</b>
Registering a scene .....	77
Selecting setting items to be included as scene assignments.....	77
<b>Selecting the sound mode</b> .....	<b>78</b>
Enjoying stereoscopic sound fields (CINEMA DSP HD <sup>3</sup> ) .....	79
Enjoying unprocessed playback.....	82
Enjoying pure high fidelity sound (Pure Direct) .....	83
Playing back digitally compressed formats (such as MP3, etc.) with enriched sound (Compressed Music Enhancer) .....	83
<b>Listening to FM/AM radio (China model only)</b> .....	<b>84</b>
Selecting a frequency for reception.....	84
Registering favorite radio stations (presets) .....	84
Operating the radio on the TV .....	86
<b>Listening to DAB radio (Australia model only)</b> .....	<b>87</b>
Preparing the DAB tuning .....	87
Selecting a DAB radio station for reception.....	88
Registering favorite DAB radio stations (presets).....	88
Displaying the DAB information .....	89
Checking reception strength of each DAB channel label .....	90
<b>Listening to FM radio (Australia model only)</b> .....	<b>92</b>
Selecting a frequency for reception.....	92
Registering favorite FM radio stations (presets).....	92
Operating the radio on the TV .....	93
<b>Playing back music via Bluetooth</b> .....	<b>95</b>
Playing back Bluetooth device music on the unit .....	95
Enjoying audio using Bluetooth speakers/headphones .....	96
<b>Playing back music stored on a USB storage device</b> .....	<b>97</b>
Connecting a USB storage device .....	97
Playback of USB storage device contents .....	98

<b>Playing back music stored on media servers (PCs/NAS)</b> .....	<b>101</b>
Media sharing setup .....	101
Playback of PC music contents .....	102
<b>Listening to Internet radio</b> .....	<b>105</b>
Playback of Internet radio .....	105
Registering favorite Internet radio stations (Favorites) .....	107
<b>Playing back iTunes/iPod music with AirPlay</b> .....	<b>108</b>
Playback of iTunes/iPod music contents .....	108
<b>Playing back videos/audio in multiple rooms (multi-zone)</b> .....	<b>110</b>
Multi-zone configuration examples .....	110
Preparing the multi zone system .....	111
Controlling Zone2, Zone3 or Zone4 .....	114
<b>Registering favorite items (shortcut)</b> .....	<b>116</b>
Registering an item.....	116
Recalling a registered item.....	116
<b>Controlling the unit from a web browser (web control)</b> .....	<b>117</b>
Top menu screen .....	118
Control screen.....	118
Settings screen.....	119
<b>Viewing the current status</b> .....	<b>120</b>
Switching information on the front display .....	120
Viewing the status information on the TV .....	121
<b>Configuring playback settings for different playback sources (Option menu)</b> .....	<b>122</b>
Option menu items.....	122
<b>CONFIGURATIONS</b> .....	<b>127</b>
<b>Configuring input sources (Input menu)</b> .....	<b>127</b>
Input menu items .....	128
<b>Configuring the SCENE function (Scene menu)</b> .....	<b>130</b>
Scene menu items .....	130
<b>Configuring sound programs/surround decoders (DSP Program menu)</b> .....	<b>133</b>
DSP Program menu items .....	134

<b>Configuring various functions (Setup menu) .....</b>	<b>136</b>
Setup menu items .....	137
Speaker (Manual Setup) .....	140
Sound .....	145
Video .....	147
HDMI .....	149
Network .....	150
Bluetooth .....	152
Multi Zone .....	153
Function .....	156
ECO .....	158
Language .....	159
<b>Viewing information about the unit (Information menu) .....</b>	<b>159</b>
Types of information .....	160
<b>Configuring the system settings (ADVANCED SETUP menu) .....</b>	<b>161</b>
ADVANCED SETUP menu items .....	162
Changing the speaker impedance setting (SPEAKER IMP.) .....	162
Turning on/off the remote control sensor (REMOTE SENSOR) .....	162
Selecting the remote control ID (REMOTE ID) .....	163
Switching the video signal type (TV FORMAT) .....	163
Removing the limitation on HDMI video output (MONITOR CHECK) .....	163
Selecting the HDMI 4K signal format (4K MODE) .....	164
Switching the DTS format notification setting (DTS MODE) .....	164
Backing up/recovering the settings (RECOV./BACKUP) .....	164
Restoring the default settings (INITIALIZE) .....	165
Updating the firmware (FIRM. UPDATE) .....	165
Checking the firmware version (VERSION) .....	165
<b>Controlling external devices with the remote control .....</b>	<b>166</b>
Registering the remote control code for a TV .....	166
Registering the remote control codes for playback devices .....	167
Resetting remote control codes .....	168
<b>Updating the unit's firmware via the network .....</b>	<b>169</b>
Updating the unit's firmware immediately .....	169
Updating the unit's firmware at power off .....	170

## APPENDIX

**171**

<b>Frequently asked questions .....</b>	<b>171</b>
<b>Troubleshooting .....</b>	<b>172</b>
First, check the following: .....	172
Power, system and remote control .....	172
Audio .....	174
Video .....	176
FM/AM radio (AM radio feature is not available on the Australia model) .....	177
DAB radio (Australia model only) .....	177
Bluetooth .....	178
USB and network .....	179
<b>Error indications on the front display .....</b>	<b>181</b>
<b>Glossary .....</b>	<b>182</b>
Audio information (audio decoding format) .....	182
Audio Information (Others) .....	184
HDMI and video information .....	184
Network information .....	185
Yamaha technologies .....	185
<b>Supported devices and file formats .....</b>	<b>186</b>
Supported devices .....	186
File formats .....	186
<b>Video signal flow .....</b>	<b>187</b>
Video conversion table .....	187
<b>Multi-zone output .....</b>	<b>188</b>
<b>Information on HDMI .....</b>	<b>188</b>
HDMI Control .....	188
Audio Return Channel (ARC) .....	190
HDMI signal compatibility .....	190
<b>Trademarks .....</b>	<b>191</b>
<b>Specifications .....</b>	<b>192</b>

# Introduction

## Accessories

Check that the following accessories are supplied with the product.

- AM antenna  
(China model only)

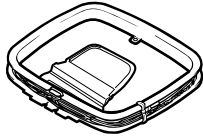

- FM antenna  
(China model only)

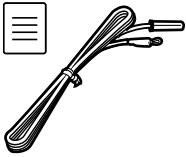

- DAB/FM antenna  
(Australia model only)

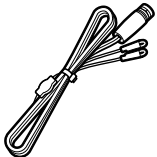

- YPAO microphone

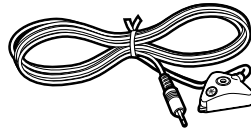

- Microphone base  
Pole

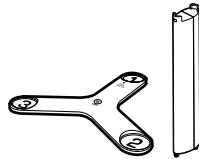

- Power cable
- Remote control
- Batteries (AAA, R03, UM-4) (x2)
- CD-ROM (Owner's Manual)
- Quick Start Guide

\* The microphone base and pole are used for angle/height measurement during YPAO.

\* The supplied power cable varies depending on the region of purchase.

## About this book

The illustrations of the main unit used in this manual are of the RX-V3083, unless otherwise specified.

In this manual, illustrations of English menu screens are used as examples.

Some features are not available in certain regions.

Due to product improvements, specifications and appearance are subject to change without notice.

This manual explains operations using the supplied remote control.

This manual describes all the “iPod touch”, “iPhone” and “iPad” as the “iPod”. “iPod” refers to “iPod touch”, “iPhone” and “iPad”, unless otherwise specified.

### Icons used in this manual



indicates precautions for use of the unit and its feature limitations.



indicates supplementary explanations for better use.

## About remote control

This section explains how to use the supplied remote control.

### Batteries

Insert the batteries the right way round.

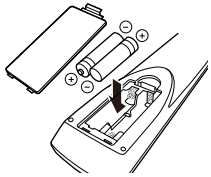

### Operating range of the remote control

Point the remote control at the remote control sensor on the unit and remain within the operating range shown below.

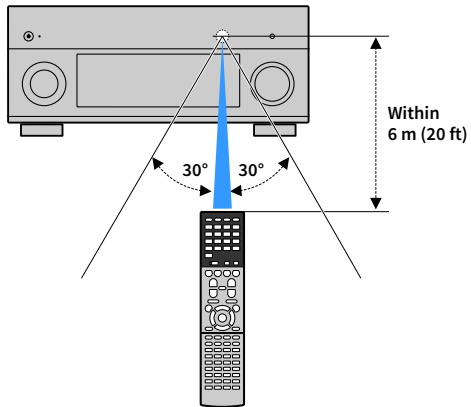

# FEATURES

## What you can do with the unit

The unit is equipped with the various useful features.

### Connecting various devices (p.41)

A number of HDMI jacks and various input/output jacks on the unit allow you to connect video devices (such as BD/DVD players), audio devices (such as CD players), game consoles, camcorders, and other devices.

### Playing back TV audio in surround sound with a single HDMI cable connection (Audio Return Channel: ARC) (p.41)

When using an ARC-compatible TV, you only need one HDMI cable to enable video output to the TV, audio input from the TV, and the transmission of HDMI Control signals.

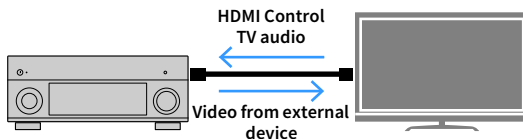

### More advanced ENTERTAINMENT sound programs (p.80)

By processing front left and front right sound fields individually, the ENTERTAINMENT sound programs are further improved in acoustic positioning and sound transition. These programs allow you to enjoy clearer vocal and instrumental sounds, distinct narrations, and more dynamic sound effects.

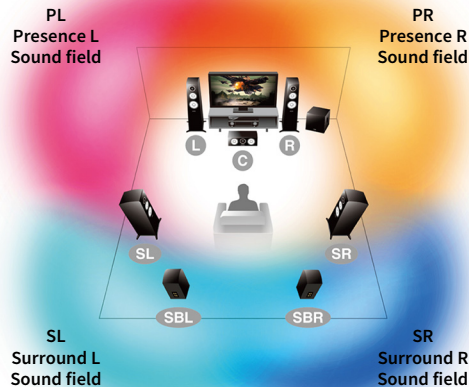

Image of sound field processing

### Various wireless connection methods (p.66)

The unit supports the Wi-Fi feature that allows the unit to connect to your wireless router (access point) without a network cable connection. In addition, Wireless Direct enables connecting a mobile device to the unit directly without router.

### Home Audio Network with MusicCast (p.74)

The unit supports the MusicCast feature that allows you to link a MusicCast compatible device to another device in a different room and play them back simultaneously, or control all MusicCast compatible devices with the dedicated application "MusicCast CONTROLLER".

### Low power consumption (p.159)

The ECO mode (power saving function) reduces the unit's power consumption.

The excitement of a concert hall and the powerful sense of being inside a movie - we all want to enjoy these experiences in our own living room. Yamaha has pursued the fulfillment of these desires for more than 30 years, and this fulfillment has now taken shape as the Yamaha AV receivers.

## What is a sound field?

We perceive sound from a voice or an instrument not only as the sounds that are heard directly but also as the “reflected” or “reverberant” sound that has been reflected by the walls or ceiling of the building. The character of the reflected and reverberant sound is affected by the shape, size, and material of the building, and all of these sounds taken together are what give us the auditory sensation of being in that specific place.

This unique acoustical character of a specific space is what we call the “sound field”.

### Conceptual diagram of a concert hall's sound field

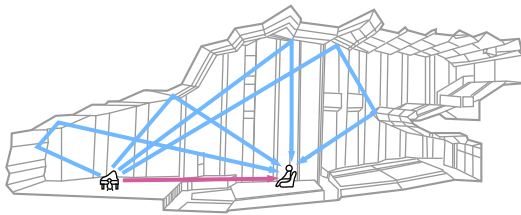

### Conceptual diagram of a sound field created by the unit

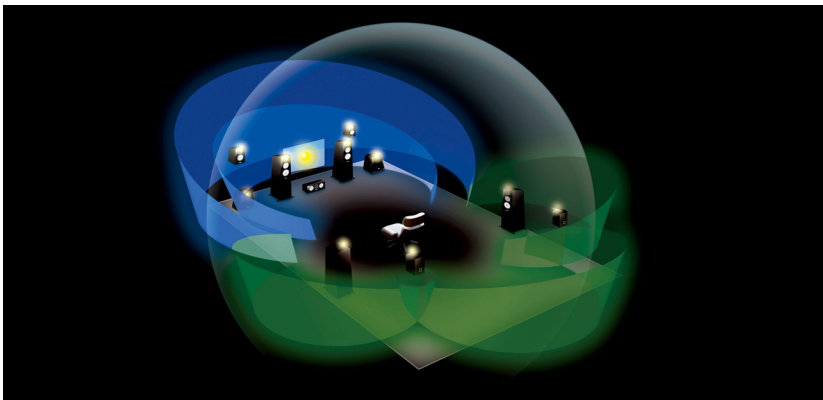

## CINEMA DSP

Yamaha has accumulated a massive amount of acoustical data by analyzing the actual sound fields of concert halls and performance spaces around the world. “CINEMA DSP” allows this data to be applied to create sound fields. This unit contains a wide variety of sound programs using CINEMA DSP.

By selecting a sound program that is appropriate to the content of the playback source such as movies, music, or games, you can maximize the acoustical effectiveness of that specific content. (For example, a sound program designed for movies can give you the sensation of actually being in that scene.)

## CINEMA DSP HD<sup>3</sup>

“CINEMA DSP HD<sup>3</sup>” is Yamaha’s flagship 3D sound field playback technology that takes full advantage of the massive amount of acoustic reflection data included in the sound field data. It delivers more than twice as much capability for generating acoustic reflections as conventional CINEMA DSP 3D, in addition to high-frequency playback capability, delivering an utterly natural and powerful spatial sound field.

### Capability for reproducing reflections (when the sound program “Hall in Munich” is selected)

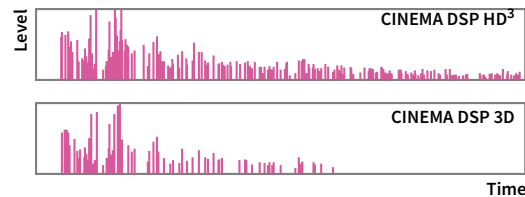



YPAO is Yamaha original automatic calibration system to optimizing your sound and surround environment by using microphone measurement. It can be create ideal listening environment for maximizing high sound quality contents playback by adjusting various speakers setting and the sound field automatically.

## YPAO-R.S.C.

In typical home, the sound has problems such as a blurred low-frequency range or a smearing of the acoustical sound image caused by undesirable sound reflection from the walls or ceiling. “YPAO-R.S.C.” is technology that reduces only the unwanted reflections and produces the acoustic perfection for your listening environment.

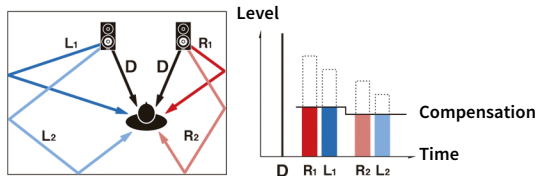

## YPAO Volume

YPAO Volume automatically adjusts the high and low frequency levels at any volume level so that you hear natural sounds even at low volume.

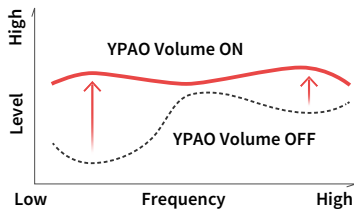

## YPAO 3D measurement

The direction (angle) of front, surround and presence speakers, and the height of presence speakers as seen from the listening position is measured, and compensation is applied to maximize the 3D sound field effectiveness of the CINEMA DSP.

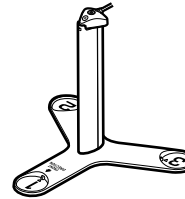

# Unrivaled audio and video quality

You can enjoy unrivaled high-quality audio and videos with the unit.

## High-resolution music enhancer

Hi-bit high-sampling extension up to 96 kHz / 24-bit can be applied to lossless 44.1/48 kHz content such as from a CD (2-channel PCM) or a FLAC file for further heightening of the musicality in the original content (p.125).

### Before processing

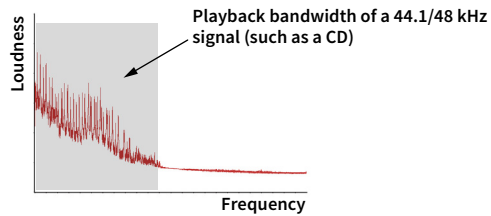

### After processing

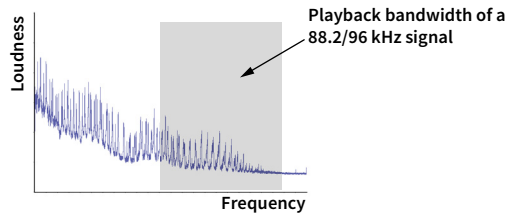

## High-quality video processing

From low-quality digital video to BD (Blu-ray disc) images, any content can be played back as a high-quality image (p.147).

- Motion adaptive and edge adaptive deinterlacing
- Multi-cadence (including 3-2 pull-down) detection
- Up to 6 presets that can be applied separately to each input source

You can also apply fine touches such as detail enhancement and edge enhancement.

## Expandable to meet diverse needs

The unit provides excellent expandability which is applicable to all uses.

### Support for bi-amp connections and external power amp expansion

To obtain even high audio quality, you can connect front speakers that support power amp expansion, or expand your system by adding an external power amp (such as a Hi-Fi amp). For details, refer to “Advanced speaker configuration” (p.30).

#### The best expandability in Yamaha (RX-V3083 only)

By connecting an external power amp, you can enjoy the highest peak of CINEMA DSP - an 11.2-channel 3-dimensional sound field.

#### (Example)

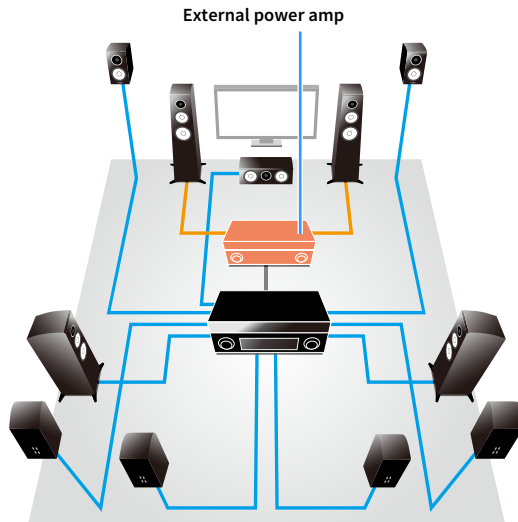

### Multi-zone function

The multi-zone function (p.110) allows you to play back different input sources in the room where the unit is installed (main zone) and in other rooms (such as Zone2).

(The following shows examples of use.)

#### Enjoying music using speakers in another room

While enjoying multichannel playback in your living room, you can listen to music through the speakers of a different room.

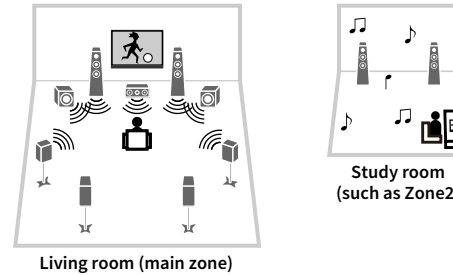

#### Enjoying videos using a TV in another room (HDMI connection)

While enjoying multichannel playback in your living room, you can enjoy videos and music being input via HDMI on a TV in a different room.

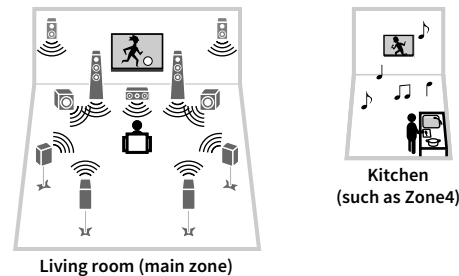

## Useful applications

The following applications provide you the flexibility to control the unit or assist you with the cable connections.

### AV CONTROLLER



“AV CONTROLLER” will turn your smartphone/tablet into a Wi-Fi enabled remote control for your Yamaha network products. This application provides you the flexibility to control the available inputs, volume, mute, power commands and playback source.

#### Functions

- Power on/off and volume adjustment
- Input, scene and sound mode selection
- DSP Parameter adjustment
- Playback control (including music selection for some sources)



For details, search for “AV CONTROLLER” on the App Store or Google Play.

### AV SETUP GUIDE (for tablet)



“AV SETUP GUIDE” is an application that assists you with cable connections between AV receiver and source devices as well as AV receiver setup. This application guides you through the various settings such as speaker connections, TV and video/audio device connections and selecting the speaker system.

#### Functions

- Connection guide (speakers, TV and video/audio devices)
- Setup guide (YPAO settings and various setup assistance with illustrations)
- Viewing owner’s manual



For details, search for “AV SETUP GUIDE” on the App Store or Google Play.

### MusicCast CONTROLLER



MusicCast CONTROLLER is an application that allows you to link a MusicCast compatible device to other MusicCast compatible devices in other rooms and play them back simultaneously. This app lets you use your smartphone or other mobile device instead of the remote control to easily select music to play back as well as configure the unit and MusicCast compatible devices.

#### Functions

- Selecting and playing back various content
  - Play back music from your mobile device
  - Select an Internet radio station
  - Play back music files stored on media servers (PCs/NAS)
  - Play back music files stored on a USB storage device
- Operating and configuring the unit
  - Select the input source, adjust the volume and mute the audio output
  - Select from a wide variety of sound processing features



For details, search for “MusicCast CONTROLLER” on the App Store or Google Play.

## Part names and functions

This section explains the functions of the parts of the unit.

### Front panel

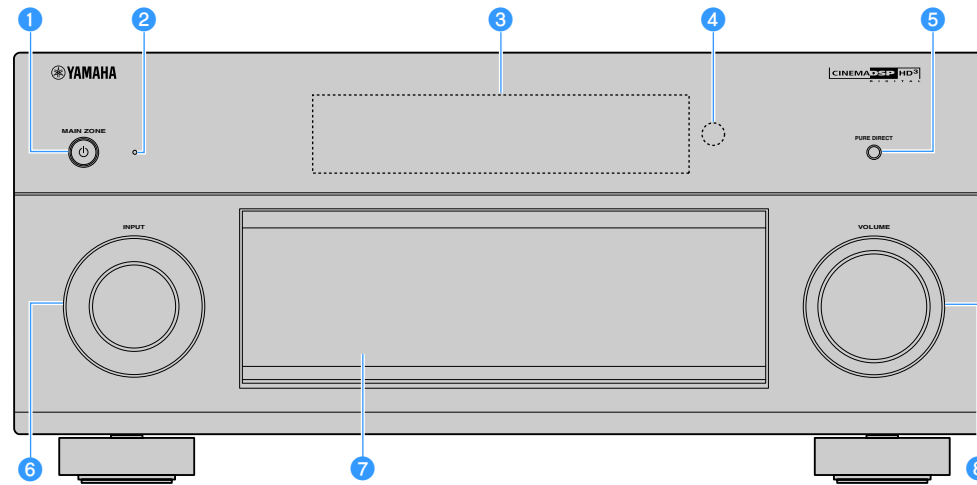

#### 1 MAIN ZONE key

Turns on/off (standby) the unit.

#### 2 Standby indicator

Lights up when the unit is in standby mode under any of the following conditions.

- HDMI Control is enabled (p.149)
- Standby Through is enabled (p.150)
- Network Standby is enabled (p.151)
- Bluetooth Standby is enabled (p.152)

#### 3 Front display

Displays information (p.15).

#### 4 Remote control sensor

Receives remote control signals (p.6).

#### 5 PURE DIRECT key

Enables/disables Pure Direct (p.83).

#### 6 INPUT knob

Selects an input source.

#### 7 Front panel door

For protecting controls and jacks (p.14).

#### 8 VOLUME knob

Adjusts the volume.

#### Opening the front panel door

To use controls or jacks behind the front panel door, gently press the bottom of the door to open it. Keep the door closed when not using controls or jacks behind the front panel door. (Be careful not to trap your fingers.)

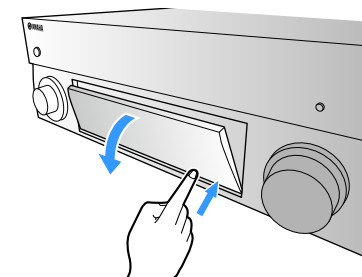

## ■ Inside of the front panel door

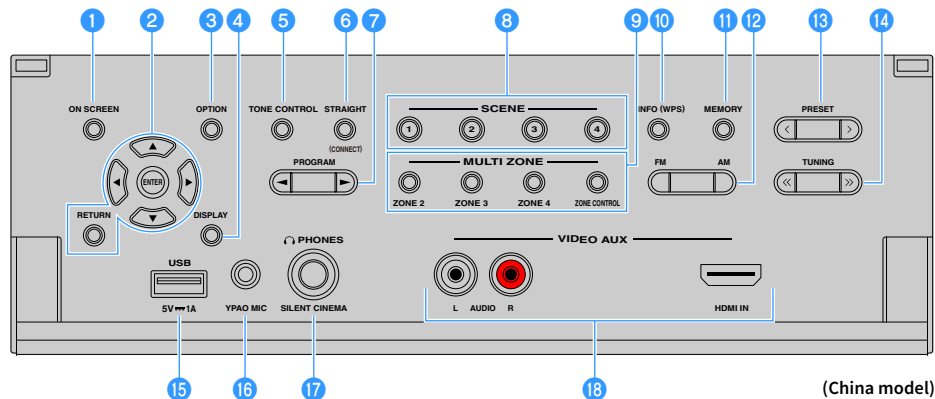

### 1 ON SCREEN key

Displays the on-screen menu on the TV.

### 2 Menu operations keys

**Cursor keys:** Select a menu or a parameter.

**ENTER:** Confirms a selected item.

**RETURN:** Returns to the previous screen.

### 3 OPTION key

Displays the option menu (p.122).

### 4 DISPLAY key

Displays status information on the TV (p.121).

### 5 TONE CONTROL key

Adjusts the high-frequency range and low-frequency range of output sounds (p.123).

### 6 STRAIGHT (CONNECT) key

Enables/disables the straight decode mode (p.82).

Enters MusicCast CONTROLLER registration by holding down for 5 seconds (p.74).

### 7 PROGRAM keys

Select a sound program or a surround decoder (p.78).

### 8 SCENE keys

Select the assigned input source (including the selected radio station or content when it is assigned), sound program, and various settings with one touch. Also, turns on the unit when it is in standby mode (p.76).

### 9 MULTI ZONE keys

**ZONE 2-4:** Enables/disables the audio output to each zone (p.114).

**ZONE CONTROL:** Changes the zone that is controlled by the keys and knobs on the front panel (p.114).

### 10 INFO (WPS) key

Selects the information displayed on the front display (p.120).

Enters the wireless network connection setup (WPS push button configuration) by holding down for 3 seconds (p.68).

### 11 MEMORY key

Registers FM/AM/DAB radio stations as preset stations (p.84, p.88, p.92).

Registers USB/network contents or Bluetooth input source as shortcuts (p.116).

### 12 FM and AM keys (China model only)

Switch between FM and AM (p.84).

### FM and DAB keys (Australia model only)

Switch between FM and DAB (p.88, p.84).

### 13 PRESET keys

Select a preset FM/DAB radio station (p.89, p.93) (Australia model) or a preset FM/AM radio station (p.85) (China model).

Selects a USB/network content from shortcuts (p.116).

### 14 TUNING keys

Select the radio frequency (p.84).

### 15 USB jack

For connecting a USB storage device (p.97).

### 16 YPAO MIC jack

For connecting the supplied YPAO microphone (p.54).

### 17 PHONES jack

For connecting headphones.

### 18 VIDEO AUX jacks

For connecting a device, such as a camcorder and a game console (p.47).

## Front display (indicators)

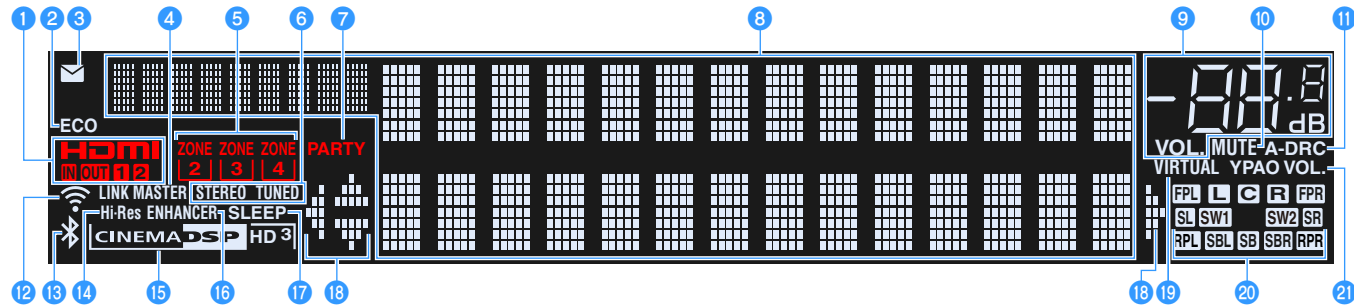

### 1 HDMI

Lights up when HDMI signals are being input or output.

#### IN

Lights up when HDMI signals are being input.

#### OUT1/OUT2

Indicates the HDMI OUT jacks currently outputting an HDMI signal.

### 2 ECO

Lights up when the unit is in the eco mode (p.159).

### 3 Firmware update indicator

Lights up when a firmware update is available via the network (p.169)

### 4 LINK MASTER

Lights up when the unit is the master device of the MusicCast network.

### 5 ZONE indicators

Lights up when Zone2, Zone3 or Zone4 is enabled (p.114).

### 6 STEREO

Lights up when the unit is receiving a stereo FM radio signal.

#### TUNED

Lights up when the unit is receiving an FM radio station signal (Australia model) or an FM/AM radio station signal (China model).

### 7 PARTY

Lights up when the unit is in the party mode (p.115).

### 8 Information display

Displays the current status (such as input name and sound mode name). You can switch the information by pressing INFO (p.120).

### 9 Volume indicator

Indicates the current volume.

### 10 MUTE

Blinks when audio is temporarily muted.

### 11 A-DRC

Lights up when Adaptive DRC (p.123) is working.

### 12 Signal strength indicator

Indicates the strength of the wireless network signal (p.66).

### 13 Bluetooth indicator

Lights up when the unit is connecting to a Bluetooth device (p.95).

### 14 Hi-Res

Lights up when the high-resolution mode (p.125) is working.

### 15 CINEMA DSP indicator

“CINEMA DSP HD” lights up when CINEMA DSP (p.79) is working.  
 “CINEMA DSP HD<sup>3</sup>” lights up when CINEMA DSP HD<sup>3</sup> is activated.

### 16 ENHANCER

Lights up when Compressed Music Enhancer (p.83) is working.

### 17 SLEEP

Lights up when the sleep timer is on.

### 18 Cursor indicators

Indicate the remote control cursor keys currently operational.

### 19 VIRTUAL

Lights up when the Virtual Presence Speaker (VPS) or Virtual Surround Back Speaker (VSBS) (p.79), or the virtual surround processing (p.81) is working.

### 20 Speaker indicators

Indicate speaker terminals from which signals are output.

**L** Front speaker (L)

**R** Front speaker (R)

**C** Center speaker

**SL** Surround speaker (L)

**SR** Surround speaker (R)

**SBL** Surround back speaker (L)

**SBR** Surround back speaker (R)

**SB** Surround back speaker

**FPL** Front presence speaker (L)

**FPR** Front presence speaker (R)

**RPL** Rear presence speaker (L)

**RPR** Rear presence speaker (R)

**SW1** Subwoofer (1)

**SW2** Subwoofer (2)

### 21 YPAO VOL.

Lights up when YPAO Volume is enabled (p.123).

# Rear panel

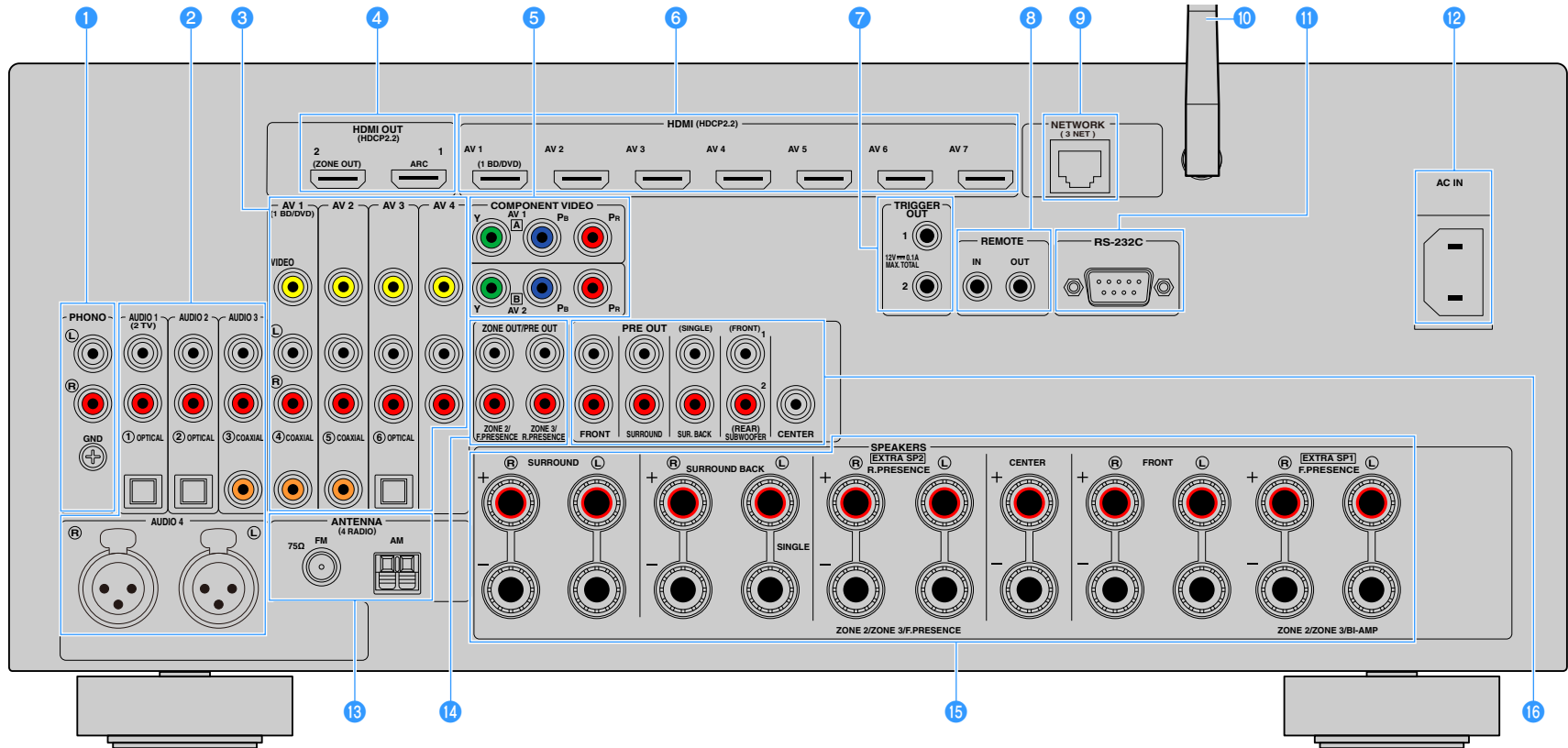

(RX-V3083)

\* The area around the video/audio output jacks is marked in white on the actual product to prevent improper connections.



#### 1 PHONO jacks

For connecting to a turntable (p.46).

#### 2 AUDIO 1-3 jacks

For connecting to audio playback devices and inputting audio signals (p.46).

#### AUDIO 4 (XLR) jacks (RX-V3083 only)

For connecting to an audio playback device and inputting audio signals (p.46).

#### 3 AV 1-4 jacks

For connecting to video/audio playback devices and inputting video/audio signals (p.44).

#### 4 HDMI OUT 1 jack

For connecting to an HDMI-compatible TV and outputting video/audio signals (p.41). When using ARC, TV audio signal can also be input through the HDMI OUT 1 jack.

#### HDMI OUT 2 (ZONE OUT) jack

For connecting to an HDMI-compatible TV and outputting video/audio signals (p.44), or for connecting to an HDMI-compatible device used in Zone2 or Zone4 (p.112).

#### 5 COMPONENT VIDEO (AV 1-2) jacks

For connecting to video playback devices that support component video and inputting video signals (p.45).

#### 6 HDMI (AV 1-7) jacks

For connecting to HDMI-compatible playback devices and inputting video/audio signals (p.44).

#### 7 TRIGGER OUT 1-2 jacks

For connecting to devices that support the trigger function (p.51).

#### 8 REMOTE IN/OUT jacks

For connecting to an infrared signal receiver/emitter that allows you to operate the unit and other devices from another room (p.113).

#### 9 NETWORK jack

For connecting to a network with a network cable (p.50).

#### 10 Wireless antenna

For a wireless (Wi-Fi) connection to a network (p.66) and a Bluetooth connection (p.95).

#### 11 RS-232C terminal

This is a control expansion terminal for custom installation. Consult your dealer for details.

#### 12 AC IN jack

For connecting the supplied power cable (p.51).

#### 13 ANTENNA jacks

For connecting to radio antennas (p.48).

#### 14 ZONE OUT/PRE OUT jacks (RX-V3083)

For connecting to an external amplifier used in Zone2 or Zone3 and outputting audio (p.111), or for connecting to an external power amplifier for front presence or rear presence channels (p.40).

#### ZONE OUT jacks (RX-V2083)

For connecting to an external amplifier used in Zone2 or Zone3 and outputting audio (p.111).

#### 15 SPEAKERS terminals

For connecting to speakers (p.20).

#### 16 PRE OUT jacks

For connecting to a subwoofer with built-in amplifier (p.28) or to an external power amplifier (p.40).

# Remote control

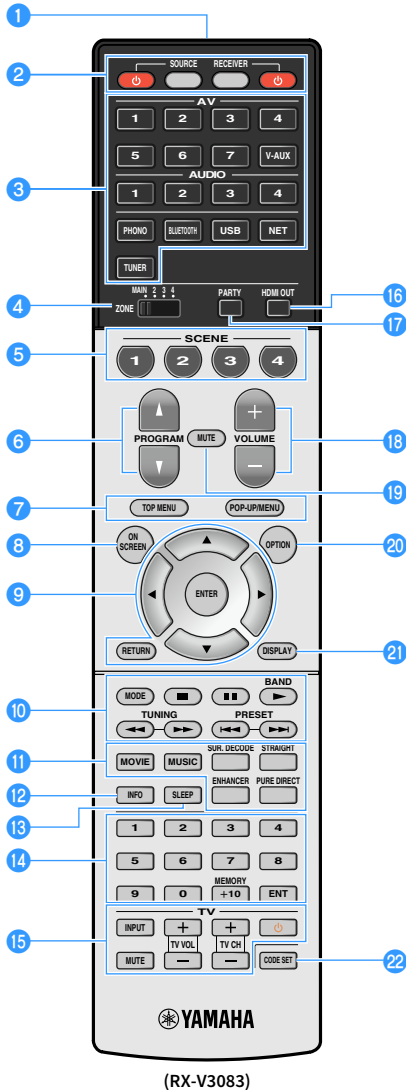

(RX-V3083)

## 1 Remote control signal transmitter

Transmits infrared signals.

## 2 RECEIVER key

Turns on/off (standby) the unit.

## RECEIVER key

Sets the remote control to operate the unit (p.167). This key lights up in orange after pressed.

## SOURCE key

Sets the remote control to operate external devices (p.167). This key lights up in green after pressed.

## SOURCE key

Turns on/off an external device.

## 3 Input selection keys

Select an input source for playback.

**AV 1-7:** AV 1-7 jacks

**V-AUX:** VIDEO AUX jacks (on the front panel)

**AUDIO 1-4 (RX-V3083):** AUDIO 1-4 jacks

**AUDIO 1-3 (RX-V2083):** AUDIO 1-3 jacks

**PHONO:** PHONO jacks

**BLUETOOTH:** Bluetooth connection (the unit as a Bluetooth receiver)

**USB:** USB jack (on the front panel)

**NET:** NETWORK sources

(press repeatedly to select a desired network source)

**TUNER:** FM/AM/DAB radio

## 4 ZONE switch

Changes the zone that is controlled by the remote control (p.114).

## 5 SCENE keys

Select the registered input source, sound program, and various settings with one touch. Also, turns on the unit when it is in standby mode (p.76).

## 6 PROGRAM keys

Select a sound program, a surround decoder, an input source, a network source, a registered item (shortcut), a browse screen page, the volume of dialogue sounds or shuffle/repeat settings (p.156).

## 7 External device operation keys

Select menus for external devices (p.167).

## 8 ON SCREEN key

Displays the on-screen menu on the TV.

## 9 Menu operation keys

**Cursor keys:** Select a menu or the parameter.

**ENTER:** Confirms a selected item.

**RETURN:** Returns to the previous screen.

## 10 Radio keys

Operate the FM/AM/DAB radio when “TUNER” is selected as the input source (p.84).

**BAND:** Switches between FM and DAB radio (Australia model), or FM and AM radio (China model).

**PRESET:** Select a preset station.

**TUNING:** Select the radio frequency.

## External device operation keys

Let you play back and perform other operations for external devices when an input source other than “TUNER” is selected (p.167).

## 11 Sound mode keys

Select a sound mode (p.78).

## 12 INFO key

Selects the information displayed on the front display (p.120).

## 13 SLEEP key

Pressing this key repeatedly will specify the time (120 min, 90 min, 60 min, 30 min, off), in which the unit switches to the standby mode.

## 14 Numeric keys

Let you enter numerical values, such as radio frequencies.

## MEMORY key

Registers FM/AM/DAB radio stations as presets (p.84, p.88, p.92). Registers USB/network contents or Bluetooth input source as shortcuts (p.116).

## 15 TV operation keys

Let you select TV input and volume, and perform other TV operations (p.166).

## 16 HDMI OUT key

Selects HDMI OUT jacks to be used for video/audio output (p.75).

## 17 PARTY key

Turns on/off the party mode (p.115).

## 18 VOLUME keys

Adjust the volume.

## 19 MUTE key

Mutes the audio output.

## 20 OPTION key

Displays the option menu (p.122).

## 21 DISPLAY key

Displays status information on the TV (p.121).

## 22 CODE SET key

Registers remote control codes of external devices on the remote control (p.166).



To operate external devices with the remote control, register a remote control code for each device before using (p.166).

# PREPARATIONS

## General setup procedure

- 1 Connecting speakers ..... (p.20)**
- 2 Connecting a TV and playback devices..... (p.41)**
- 3 Connecting the radio antennas..... (p.48)**
- 4 Connecting a network cable or preparing the wireless antenna ..... (p.50)**
- 5 Connecting other devices ..... (p.51)**
- 6 Connecting the power cable ..... (p.51)**
- 7 Selecting an on-screen menu language ..... (p.52)**
- 8 Configuring the necessary speaker settings ..... (p.53)**
- 9 Optimizing the speaker settings automatically (YPAO)..... (p.54)**
- 10 Connecting to a network device wirelessly..... (p.66)**
- 11 Connecting to the MusicCast network..... (p.74)**

This completes all the preparations. Enjoy playing movies, music, radio and other content with the unit!

# 1 Connecting speakers

The unit has 9 built-in amplifiers. You can connect 2 to 11 speakers and up to 2 subwoofers to create the favorite acoustic space in your room.

You can also apply bi-amp connections, channel expansion (using an external power amplifier) or multi-zone configurations to enhance your system (p.30).

## Caution

Under its default settings, the unit is configured for 8-ohm speakers. When connecting 6-ohm speakers, set the unit's speaker impedance to "6 Ω MIN". In this case, you can also use 4-ohm speakers as the front speakers. For details, see "Setting the speaker impedance" (p.27).

## Ideal speaker layout

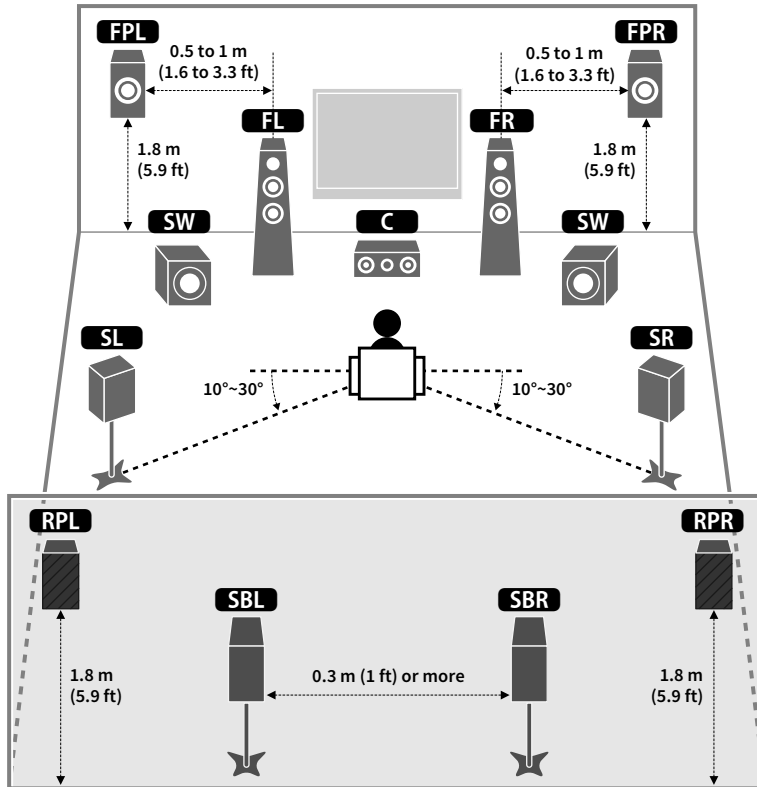

## Functions of each speaker

Speaker type	Function
Front (L/R) FL FR	Produce front left/right channel sounds (stereo sounds).
Center C	Produces center channel sounds (such as movie dialogues and vocals).
Surround (L/R) SL SR	Produce surround left/right channel sounds. Surround speakers also produce surround back channel sounds when no surround back speakers are connected.
Surround back (L/R) SBL SBR	Produce surround back left/right channel sounds.
Front presence (L/R) FPL FPR	Produce CINEMA DSP effect sounds or heights channel sounds of Dolby Atmos and DTS:X contents.
Rear presence (L/R) RPL RPR	Produce CINEMA DSP effect sounds or heights channel sounds of Dolby Atmos and DTS:X contents.
Subwoofer SW	Produces LFE (low-frequency effect) channel sounds and reinforces bass parts of other channels. This channel is counted as "0.1". You can connect 2 subwoofers to the unit and place them on the left/right (or front/rear) sides of the room.



- Use "Ideal speaker layout" (diagram on the right) as reference. You do not need to exactly adjust the speaker layout to this diagram since the YPAO function of the unit will automatically optimize the speaker settings (such as distances) to suit the speaker layout.
- When using only one surround back speaker, place it straight behind the listening position (middle of "SBL" and "SBR" in the diagram).
- The unit creates front Virtual Presence Speaker (VPS) using the front, center, and surround speakers to produce 3-dimensional sound fields even when no front presence speakers are connected. However, we recommend using front presence speakers in order to experience the full effect of the sound fields (and rear presence speakers for further spatial sounds).
- The unit creates rear Virtual Presence Speaker (VPS) using the front, center, and surround speakers to produce natural 3-dimensional sound fields when front presence speakers are connected but no rear presence speakers.

## Basic speaker configuration

If you do not apply bi-amp connections, channel expansion (using an external amplifier) or multi-zone configurations, follow the procedure below to place the speakers in your room and connect them to the unit.

### ■ Placing speakers in your room

Depending on the number of speakers, place the speakers and subwoofer in your room. This section describes the representative speaker layout examples.



- To have a full effect of Dolby Atmos contents, we recommend using a speaker system with a ★ mark. However, you can also play back Dolby Atmos contents with the 7.1 system (using surround back speakers).
- To have a full effect of DTS:X contents, we recommend using a speaker system with a ★ mark.
- (About the number of channels) For example, “5.1.2” denotes “standard 5.1-channel plus 2 for overhead speaker channels”. For details on how to place overhead speakers (presence speakers), see “Presence speaker layout” (p.26).

### 7.2.2/5.2.4 system [★]

#### (using both surround back and rear presence speakers)

This speaker system brings out the full performance of the unit and allows you to enjoy a highly-natural 3-dimensional sound field with any contents.

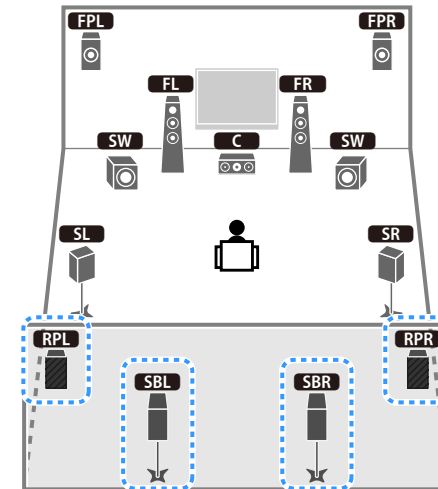

- The surround back speakers and rear presence speakers do not produce sounds simultaneously. The unit automatically changes the speakers to be used, depending on the input signal and CINEMA DSP (p.79).
- When using front presence and rear presence speakers installed to the ceiling or when using the Dolby Enabled speakers as the presence speakers, configure the “Layout (Front Presence/Rear Presence)” setting in the “Setup” menu before performing YPAO (p.53).
- (RX-V3083 only)

By using an external power amplifier (p.31), you can make an 11-channel system [★7.2.4] and enjoy Dolby Atmos and DTS:X contents with the front presence and rear presence speakers.

### 5.2.4 system [★] (using rear presence speakers)

This speaker system uses the front and rear presence speakers to produce a highly-natural 3-dimensional sound field, and also creates Virtual Surround Back Speaker (VSBS) using the surround speakers to add a sense of depth to the rear sound field. This system is suited for enjoying not only 5.1-channel but also for 7.1-channel contents.

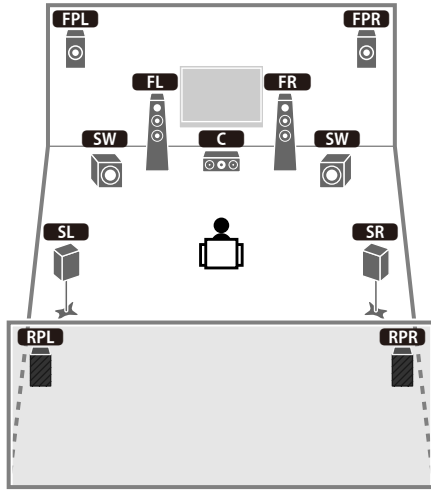

When using front presence and rear presence speakers installed to the ceiling or when using the Dolby Enabled speakers as the presence speakers, configure the “Layout (Front Presence/Rear Presence)” setting in the “Setup” menu before performing YPAO (p.53).

### 7.2.2 system [★] (using surround back speakers)

This speaker system uses the front presence speakers to produce a natural 3-dimensional sound field, and also allows you to enjoy extended surround sounds using the surround back speakers.

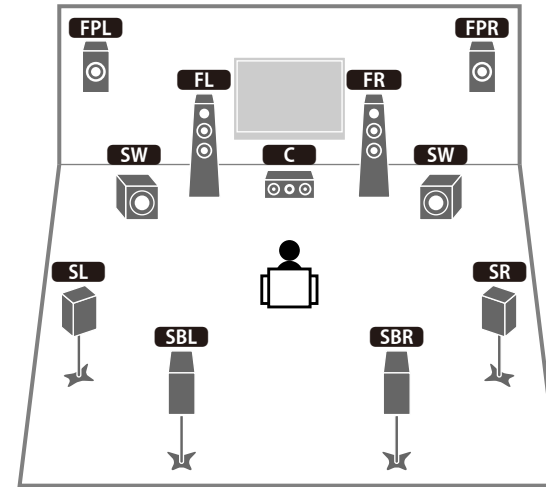

- When using front presence speakers installed to the ceiling or when using the Dolby Enabled speakers as the presence speakers, configure the “Layout (Front Presence)” setting in the “Setup” menu before performing YPAO (p.53).
- This speaker system creates rear Virtual Presence Speaker (VPS) using the front, center and surround speakers to produce a natural 3-dimensional sound field.

### 5.1.2 system [★] (using front presence speakers)

This speaker system uses the front presence speakers to produce a natural 3-dimensional sound field, and also creates Virtual Surround Back Speaker (VSBS) using the surround speakers to add a sense of depth to the rear sound field. This system is suited for enjoying not only 5.1-channel but also for 7.1-channel contents.

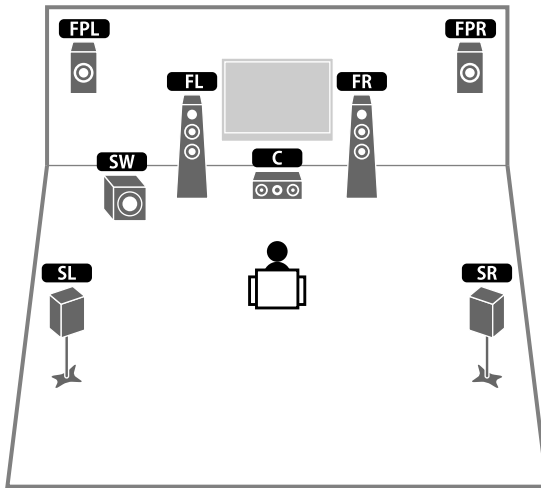

- When using front presence speakers installed to the ceiling or when using the Dolby Enabled speakers as the presence speakers, configure the “Layout (Front Presence)” setting in the “Setup” menu before performing YPAO (p.53).
- This speaker system creates rear Virtual Presence Speaker (VPS) using the front, center and surround speakers to produce a natural 3-dimensional sound field.

### 7.1 system (using surround back speakers)

This speaker system creates front Virtual Presence Speaker (VPS) using the front, center and surround speakers to produce a 3-dimensional sound field, and also allows you to enjoy extended surround sounds using the surround back speakers.

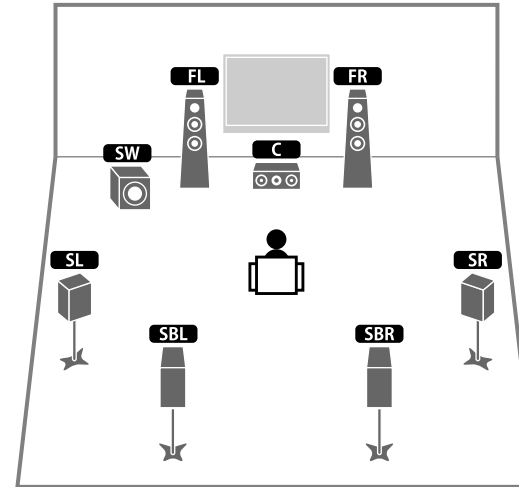

## 5.1 system

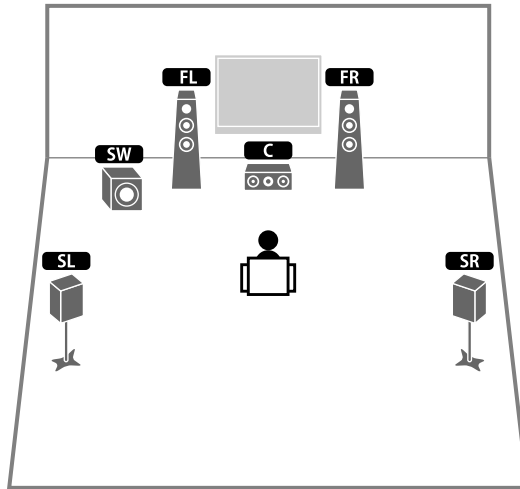

You can enjoy surround sound even without the center speaker (4.1 system).

## 5.1 system (front 5.1-channel) (using surround speakers)

We recommend using this speaker system when you cannot place speakers in the rear side of the room.

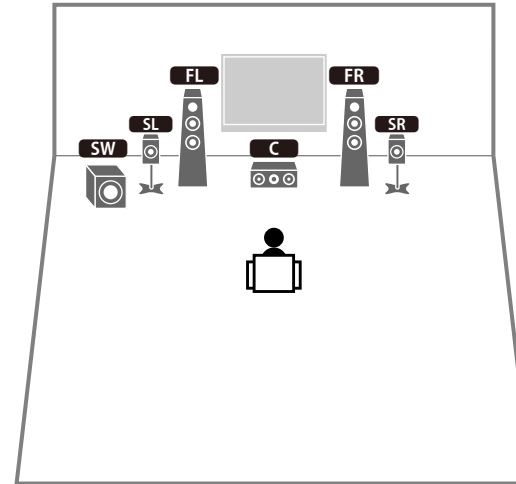

When placing surround speakers in the front side, set "Layout (Surround)" in the "Setup" menu to "Front" before performing YPAO (p.53).



## 5.1 system (front 5.1-channel) (using front presence speakers)

We recommend using this speaker system when you cannot place speakers in the rear side of the room.

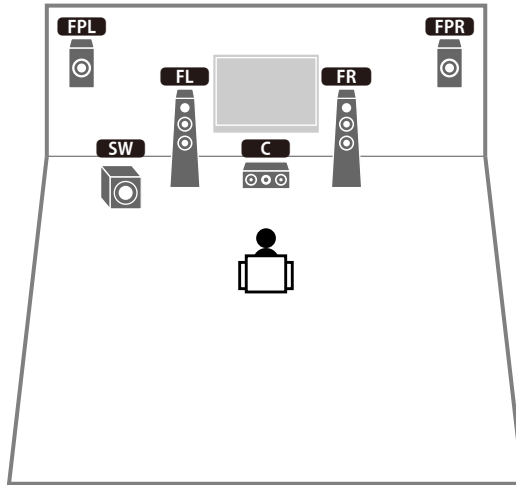

When using front presence speakers installed to the ceiling or when using the Dolby Enabled speakers as the presence speakers, configure the “Layout (Front Presence)” setting in the “Setup” menu before performing YPAO (p.53).

## 2.1 system

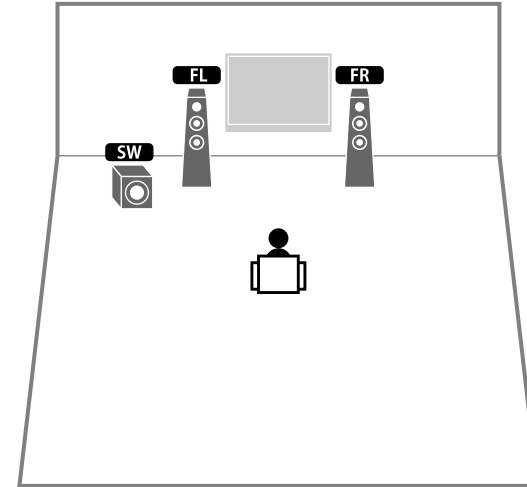

Add the center speaker to configure a 3.1 system.

## Presence speaker layout

The unit provides three layout patterns for presence speakers (Front Height/Rear Height, Overhead and Dolby Enabled SP). Choose a layout pattern that suits your listening environment.



- You can enjoy Dolby Atmos, DTS:X or Cinema DSP HD<sup>3</sup> with any layout pattern.
- You can configure the placement patterns for front presence and rear presence speakers separately.

### Front Height/Rear Height

Install the presence speakers on the front/rear side wall.

It delivers a natural sound field with excellent linkage of left, right, top and bottom sound spaces, and sound extensity effectively.

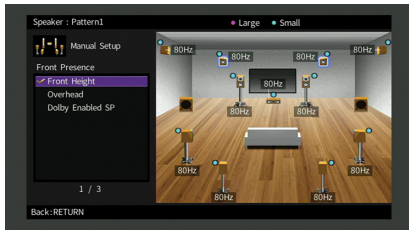

### Overhead

Install the presence speakers to the ceiling above the listening position.

It delivers realistic overhead sound effects and sound field with excellent linkage of front and rear sound spaces effectively.

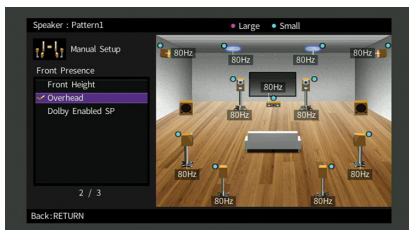

For details on the installation position of ceiling speakers, see “Notes on installation of ceiling speakers” (p.26).

### Dolby Enabled SP

Use the Dolby Enabled speakers as the presence speakers.

It utilizes sounds reflected from ceiling and lets you enjoy overhead sounds only from speakers that are placed at the same level as traditional speakers.

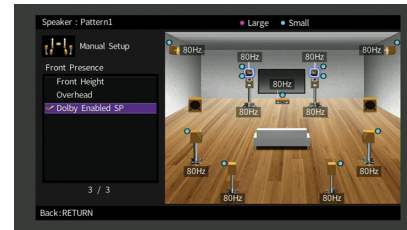

Place the Dolby Enabled speakers on top of or near the traditional front speakers. A Dolby Enabled speaker unit may be integrated into a traditional speaker. For details, refer to the instruction manual of the Dolby Enabled speakers.

### Notes on installation of ceiling speakers

When installing presence speakers to a ceiling, use the following illustration as a reference.

#### When using two presence speakers

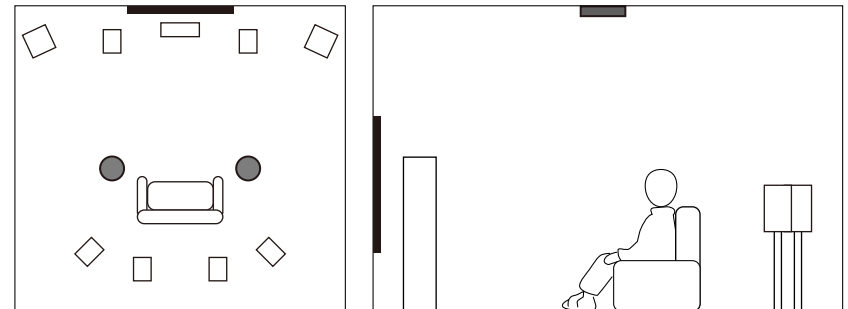

#### Installation position

Just above the listening position, or the ceiling between extensions of front speakers and listening position

## When using four presence speakers

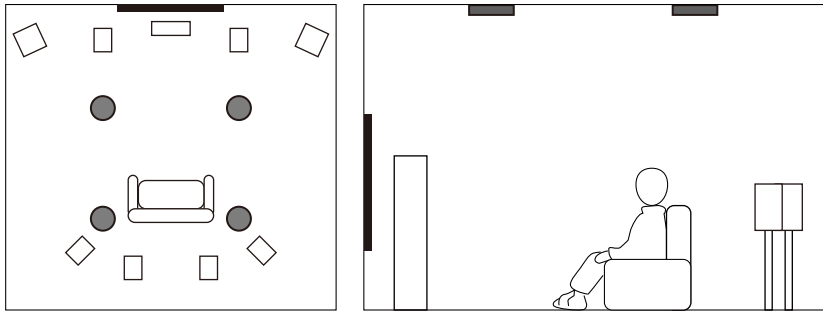

### Installation position

Front presence speakers:

the ceiling between the extensions of the front speakers and listening position

Rear presence speakers:

the ceiling between the extensions of the listening position and surround (or surround back) speakers

#### Caution

Be sure to use speakers that are made for ceiling use and take anti-drop measures. Ask a qualified contractor or dealer personnel for installation works.

## Setting the speaker impedance

Under its default settings, the unit is configured for 8-ohm speakers. When using a 6-ohm speaker for any channel, set the speaker impedance to “6 Ω MIN”. In this case, you can also use 4-ohm speakers as the front speakers.

- 1 Before connecting speakers, connect the power cable to an AC wall outlet.
- 2 While holding down STRAIGHT on the front panel, press MAIN ZONE .

MAIN ZONE  STRAIGHT

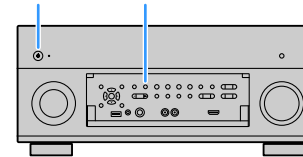

- 3 Check that “SPEAKER IMP.” is displayed on the front display.



- 4 Press STRAIGHT to select “6 Ω MIN”.
- 5 Press MAIN ZONE  to set the unit to standby mode and remove the power cable from the AC wall outlet.

You are now ready to connect the speakers.

## Connecting speakers

Connect the speakers placed in your room to the unit.

### Precaution for connecting of the speaker cables

Prepare speaker cables in a place away from the unit, to avoid accidentally dropping wire strands into the unit's interior which could result in a short circuit or malfunction of the unit.

Improper connecting of the speaker cables may cause short circuit and also damage the unit or the speakers.

- Remove the unit's power cable from an AC wall outlet and turn off the subwoofer before connecting the speakers.
- Twist the bare wires of the speaker cables firmly together.

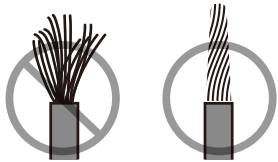

- Do not let the bare wires of the speaker cable touch one another.

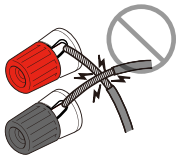

- Do not let the bare wires of the speaker cable come into contact with the unit's metal parts (rear panel and screws).

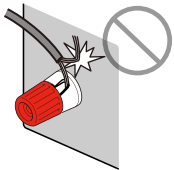

If "Check SP Wires" appear on the front display when the unit is turned on, turn off the unit, and then check the speaker cables short circuit.

### Speakers to be connected

Speaker type	Speaker system (the number of channels)			
	7.2.2/5.2.4	7.1/5.1.2	5.1	2.1
Front (L/R) <b>FL</b> <b>FR</b>	●	●	●	●
Center <b>C</b>	●	●	●	
Surround (L/R) <b>SL</b> <b>SR</b>	●	●	○*5	
Surround back (L/R) <b>SBL</b> <b>SBR</b>	○*1	○*3		
Front presence (L/R) <b>FPL</b> <b>FPR</b>	●	○*4	○*6	
Rear presence (L/R) <b>RPL</b> <b>RPR</b>	○*2			
Subwoofer <b>SW</b>	●	●	●	●

If you have eleven speakers, you can connect the both surround back speakers and rear presence speakers. In this case, the unit automatically changes the speakers to be used, depending on the input signal and CINEMA DSP.

If you have nine speakers, use two of them as surround back speakers (\*1) or rear presence speakers (\*2).

If you have seven speakers, use two of them as surround back speakers (\*3) or front presence speakers (\*4).

If you have five speakers, use two of them as surround speakers (\*5) or front presence speakers (\*6).



- You can also connect up to 2 subwoofers (with built-in amplifier) to the unit. When using 2 subwoofers, configure the "Layout (Subwoofer)" setting (p.143) in the "Setup" menu after connecting the power cable to an AC wall outlet.
- When apply this speaker configuration, set "Power Amp Assign" (p.140) to "Basic" (default).
- To use an external power amplifier (Hi-Fi amplifier, etc.) to enhance speaker output, see "Connecting an external power amplifier" (p.40).

### Cables necessary for connection (commercially available)

Speaker cables (x the number of speakers)



Audio pin cable (two for connecting two subwoofers)



## Connection diagram

Refer to the following diagram and connect the speakers to the unit.

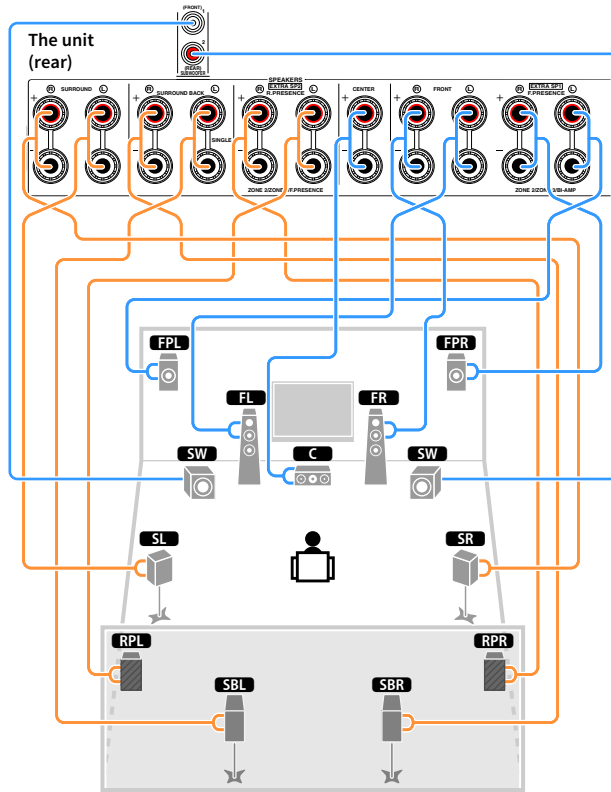

When using only one surround back speaker, connect it to the SINGLE jack (L side).

## Connecting speaker cables

Speaker cables have two wires. One is for connecting the negative (-) terminal of the unit and the speaker, and the other is for the positive (+) terminal. If the wires are colored to prevent confusion, connect the black wire to the negative and the other wire to the positive terminal.

- 1 Remove approximately 10 mm (3/8") of insulation from the ends of the speaker cable, and twist the bare wires of the cable firmly together.
- 2 Loosen the speaker terminal.
- 3 Insert the bare wires of the cable into the gap on the side (upper right or bottom left) of the terminal.
- 4 Tighten the terminal.

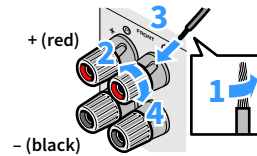

### Using a banana plug

(China model only)

- 1 Tighten the speaker terminal.
- 2 Insert a banana plug into the end of the terminal.

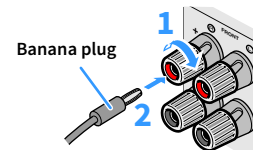

## Connecting the subwoofer (with built-in amplifier)

Use an audio pin cable to connect the subwoofer.

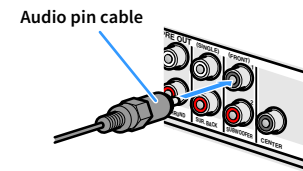

# Advanced speaker configuration

In addition to the basic speaker configuration (p.21), the unit also allows you to apply the following speaker configurations to enhance your system.

**Using the four internal amplifiers for front speakers to have more high-quality sounds**

**Bi-amp connection**

(Example)

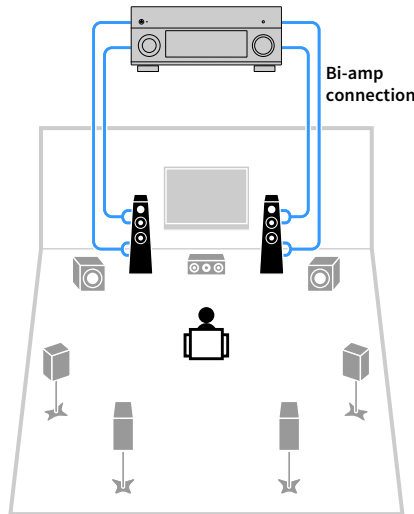

**Combining with an external power amplifier (Hi-Fi amplifier, multichannel amplifier, etc.) to build an extended system**

**Power-amp channel expansion**

(Example)

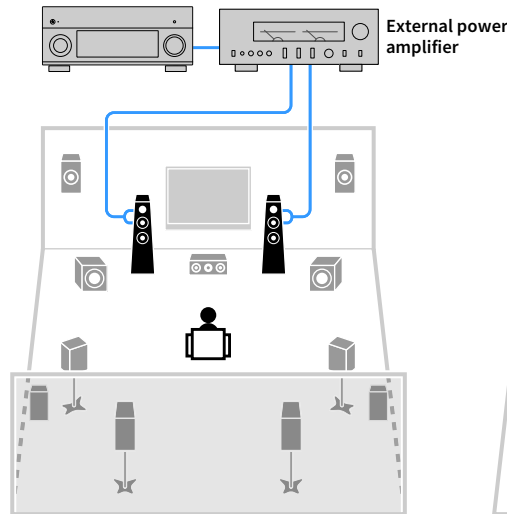

**Using the excess internal amplifiers for stereo speakers in another room**

**Multi-zone configuration**

(Example)

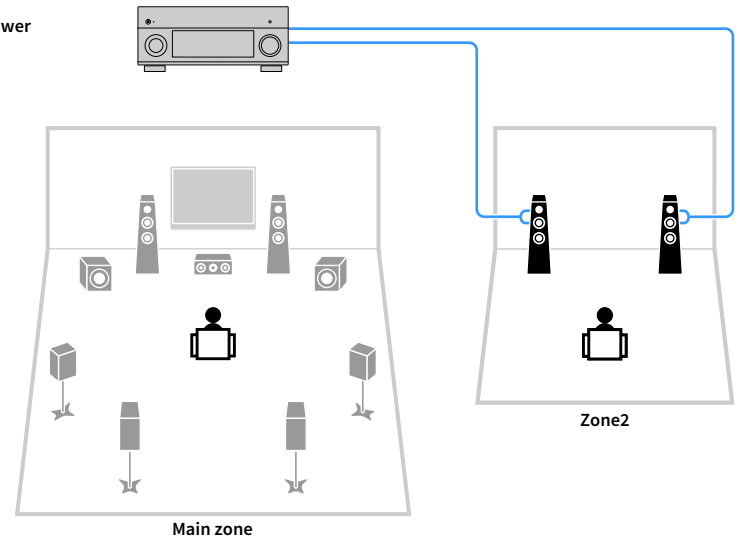

## Available speaker configurations

(RX-V3083)

Main zone				Multi-zone	Power Amp Assign (p.140)	Page
Output channel (max)	Bi-amp	External speakers	External power amplifier (required)			
7		Surround back		+1 room	7.2 +1Zone	32
9		Surround back Front presence		+1 room	7.2.2 +1Zone	32
7		Surround back		+2 rooms	7.2 +2Zone	33
11		Surround back Front presence	Rear presence		7.2.4 [ext.RP]	33
11		Surround back Front presence Rear presence	Front		7.2.4 [ext.Front]	34
11		Surround back	Front presence Rear presence		7.2.4 [ext.FP+RP]	34
9		Surround back Front presence	Front	+1 room	7.2.2 [ext.Front] +1Zone	35
7		Surround back	Front	+2 rooms	7.2 [ext.Front] +2Zone	35
7	○	Surround back			7.2 Bi-Amp	36
7	○	Front presence			5.2.2 Bi-Amp	36
7	○	Surround back		+1 room	7.2 Bi-Amp +1Zone	37
11	○	Surround back	Front presence Rear presence		7.2.4 Bi-Amp [ext.FP+RP]	37
9	○	Front presence	Rear presence		5.2.4 Bi-Amp [ext.RP]	38

(RX-V2083)

Main zone				Multi-zone	Power Amp Assign (p.140)	Page
Output channel (max)	Bi-amp	External speakers	External power amplifier (required)			
7		Surround back		+1 room	7.2 +1Zone	32
9		Surround back Front presence		+1 room	7.2.2 +1Zone	32
7		Surround back		+2 rooms	7.2 +2Zone	33
9		Surround back Front presence	Front	+1 room	7.2.2 [ext.Front] +1Zone	35
7		Surround back	Front	+2 rooms	7.2 [ext.Front] +2Zone	35
7	○	Surround back			7.2 Bi-Amp	36
7	○	Front presence			5.2.2 Bi-Amp	36
7	○	Surround back		+1 room	7.2 Bi-Amp +1Zone	37



- When applying one of these configurations, you need to configure the “Power Amp Assign” setting in the “Setup” menu (p.53).
- When applying a multi-zone configuration, you can select a zone (Zone2 or Zone3) to be assigned to the EXTRA SP 1-2 jacks in “Power Amp Assign” (p.140) in the “Setup” menu. The following explanation is based on the assumption that you have not changed the default zone assignments.

## 7.2 +1Zone

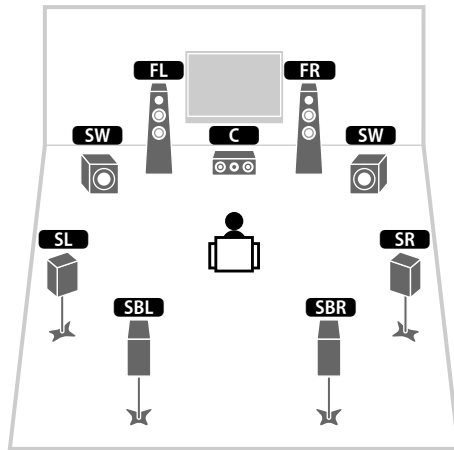

Main zone

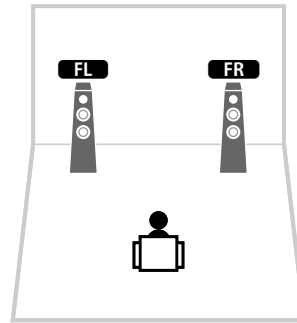

Zone2

## 7.2.2 +1Zone

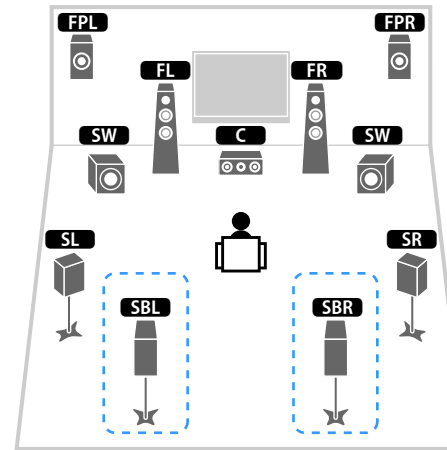

Main zone

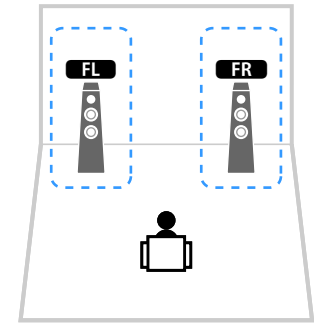

Zone2

Speaker	Connect to
<b>FL</b> <b>FR</b>	FRONT
<b>C</b>	CENTER
<b>SL</b> <b>SR</b>	SURROUND
<b>SBL</b> <b>SBR</b>	SURROUND BACK
<b>FPL</b> <b>FPR</b>	(not used)
<b>RPL</b> <b>RPR</b>	(not used)
<b>SW</b>	SUBWOOFER 1-2
Zone2 speakers	EXTRA SP 1

Speaker	Connect to
<b>FL</b> <b>FR</b>	FRONT
<b>C</b>	CENTER
<b>SL</b> <b>SR</b>	SURROUND
<b>SBL</b> <b>SBR</b>	SURROUND BACK
<b>FPL</b> <b>FPR</b>	EXTRA SP 1
<b>RPL</b> <b>RPR</b>	(not used)
<b>SW</b>	SUBWOOFER 1-2
Zone2 speakers	EXTRA SP 2



When Zone2 output is enabled (p.114), the surround back speakers in the main zone do not output sound.



## 7.2 +2Zone

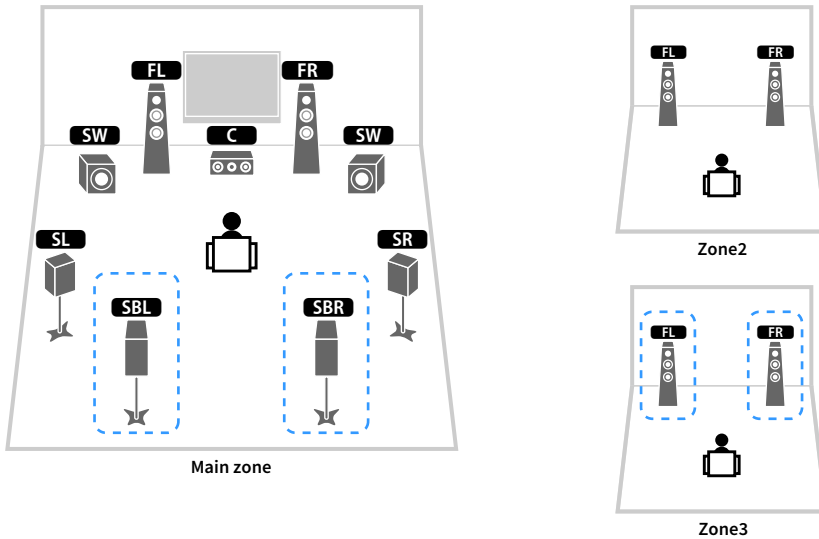

## 7.2.4 [ext.RP] (RX-V3083 only)

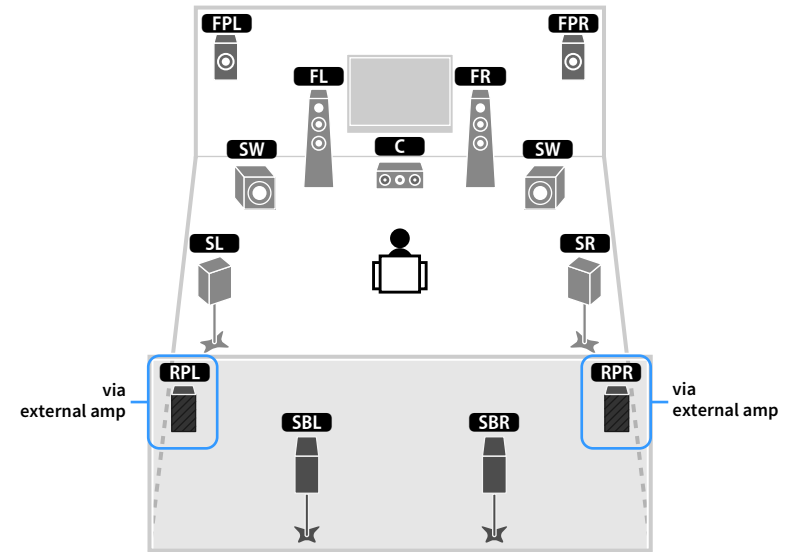

Speaker	Connect to
<b>FL</b> <b>FR</b>	FRONT
<b>C</b>	CENTER
<b>SL</b> <b>SR</b>	SURROUND
<b>SBL</b> <b>SBR</b>	SURROUND BACK
<b>FPL</b> <b>FPR</b>	(not used)
<b>RPL</b> <b>RPR</b>	(not used)
<b>SW</b>	SUBWOOFER 1-2
Zone2 speakers	EXTRA SP 1
Zone3 speakers	EXTRA SP 2

Speaker	Connect to
<b>FL</b> <b>FR</b>	FRONT
<b>C</b>	CENTER
<b>SL</b> <b>SR</b>	SURROUND
<b>SBL</b> <b>SBR</b>	SURROUND BACK
<b>FPL</b> <b>FPR</b>	EXTRA SP 1
<b>RPL</b> <b>RPR</b>	R.PRESENCE (PRE OUT) via external power amplifier
<b>SW</b>	SUBWOOFER 1-2



When Zone3 output is enabled (p.114), the surround back speakers in the main zone do not output sound.



When this configuration is applied, you cannot utilize the ZONE OUT/PRE OUT jacks for connecting an external amplifier for Zone3 (p.111).

## 7.2.4 [ext.Front] (RX-V3083 only)

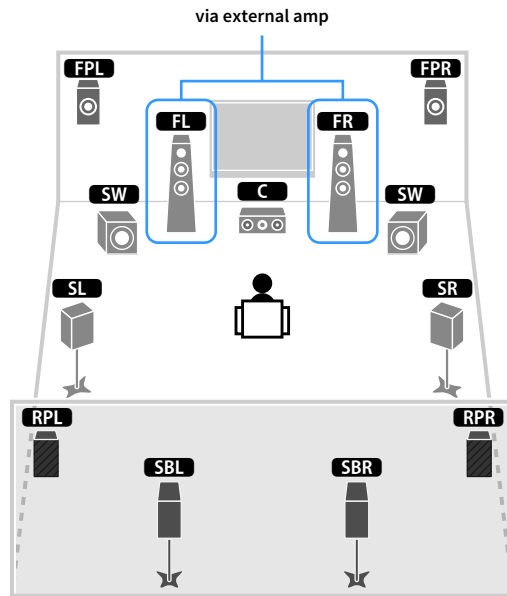

Speaker	Connect to
<b>FL FR</b>	FRONT (PRE OUT) via external power amplifier
<b>C</b>	CENTER
<b>SL SR</b>	SURROUND
<b>SBL SBR</b>	SURROUND BACK
<b>FPL FPR</b>	EXTRA SP 1
<b>RPL RPR</b>	EXTRA SP 2
<b>SW</b>	SUBWOOFER 1-2



When this configuration is applied, you cannot utilize the ZONE OUT/PRE OUT jacks for connecting an external amplifier for Zone3 (p.111).

## 7.2.4 [ext.FP+RP] (RX-V3083 only)

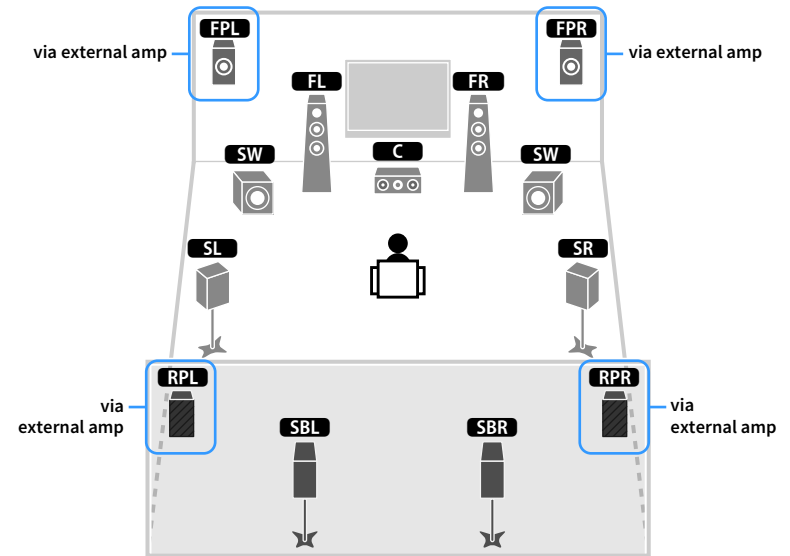

Speaker	Connect to
<b>FL FR</b>	FRONT
<b>C</b>	CENTER
<b>SL SR</b>	SURROUND
<b>SBL SBR</b>	SURROUND BACK
<b>FPL FPR</b>	F.PRESENCE (PRE OUT) via external power amplifier
<b>RPL RPR</b>	R.PRESENCE (PRE OUT) via external power amplifier
<b>SW</b>	SUBWOOFER 1-2



When this configuration is applied, you cannot utilize the ZONE OUT/PRE OUT jacks for connecting external amplifiers for Zone2 and Zone3 (p.111).

## 7.2.2 [ext.Front] +1Zone

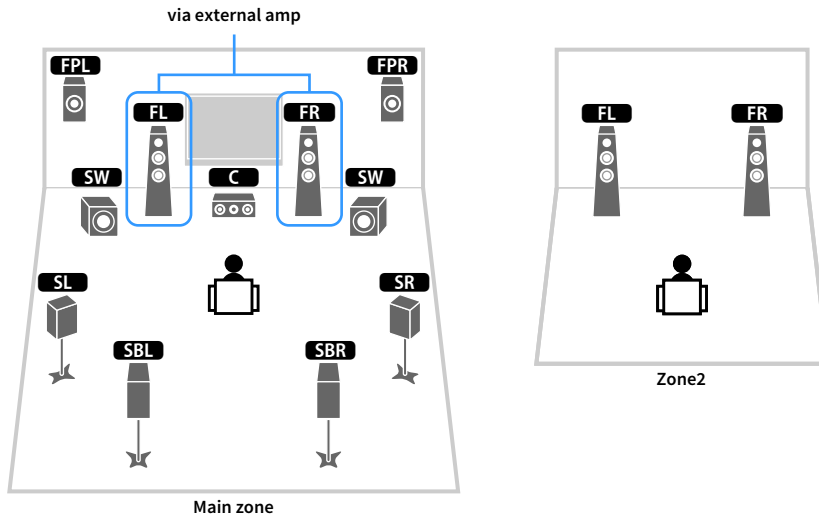

## 7.2 [ext.Front] +2Zone

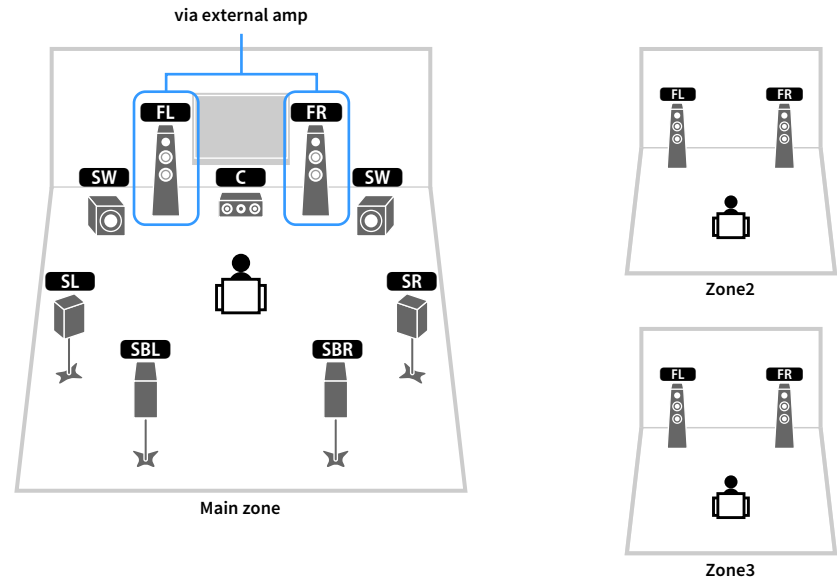

Speaker	Connect to
<b>FL</b> <b>FR</b>	FRONT (PRE OUT) via external power amplifier
<b>C</b>	CENTER
<b>SL</b> <b>SR</b>	SURROUND
<b>SBL</b> <b>SBR</b>	SURROUND BACK
<b>FPL</b> <b>FPR</b>	EXTRA SP 1
<b>RPL</b> <b>RPR</b>	(not used)
<b>SW</b>	SUBWOOFER 1-2
Zone2 speakers	EXTRA SP 2

Speaker	Connect to
<b>FL</b> <b>FR</b>	FRONT (PRE OUT) via external power amplifier
<b>C</b>	CENTER
<b>SL</b> <b>SR</b>	SURROUND
<b>SBL</b> <b>SBR</b>	SURROUND BACK
<b>FPL</b> <b>FPR</b>	(not used)
<b>RPL</b> <b>RPR</b>	(not used)
<b>SW</b>	SUBWOOFER 1-2
Zone2 speakers	EXTRA SP 1
Zone3 speakers	EXTRA SP 2

## 7.2 Bi-Amp

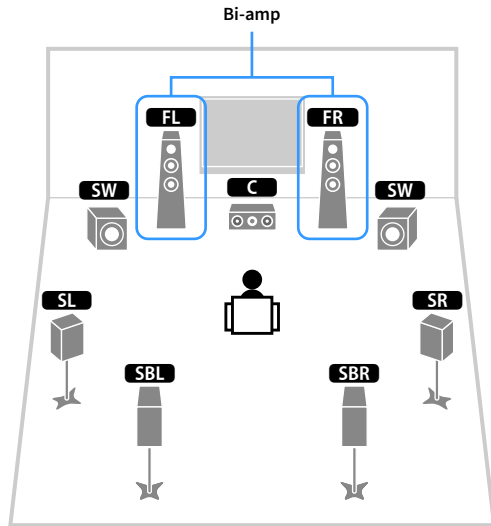

Speaker	Connect to
<b>FL</b> <b>FR</b>	FRONT and EXTRA SP 1 (bi-amp connection)
<b>C</b>	CENTER
<b>SL</b> <b>SR</b>	SURROUND
<b>SBL</b> <b>SBR</b>	SURROUND BACK
<b>FPL</b> <b>FPR</b>	(not used)
<b>RPL</b> <b>RPR</b>	(not used)
<b>SW</b>	SUBWOOFER 1-2

## 5.2.2 Bi-Amp

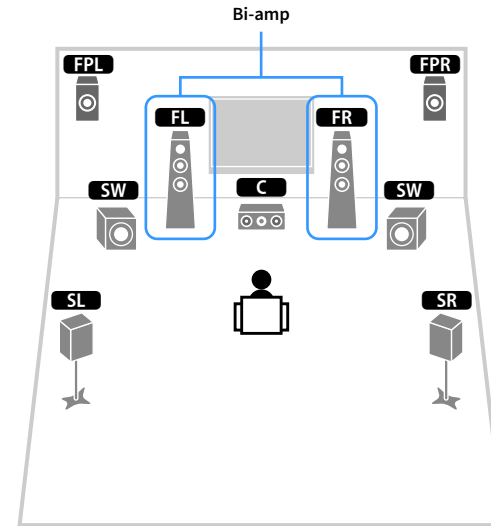

Speaker	Connect to
<b>FL</b> <b>FR</b>	FRONT and EXTRA SP 1 (bi-amp connection)
<b>C</b>	CENTER
<b>SL</b> <b>SR</b>	SURROUND
<b>SBL</b> <b>SBR</b>	(not used)
<b>FPL</b> <b>FPR</b>	EXTRA SP 2
<b>RPL</b> <b>RPR</b>	(not used)
<b>SW</b>	SUBWOOFER 1-2

## 7.2 Bi-Amp +1Zone

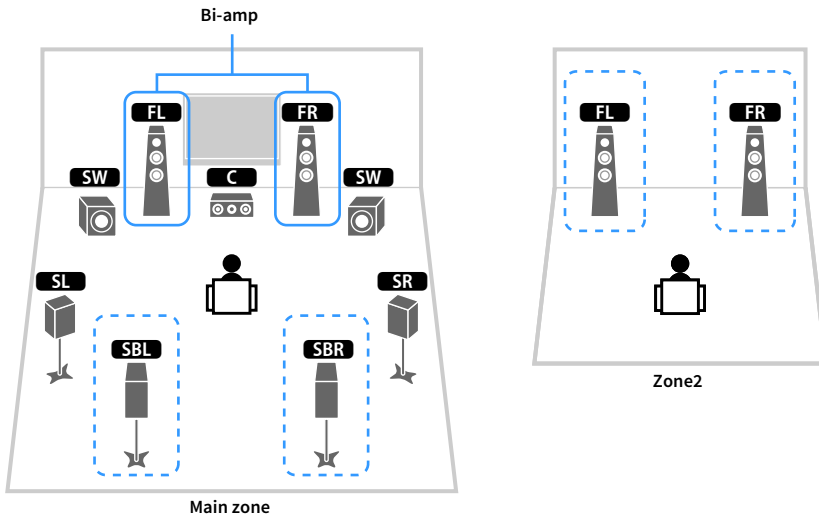

## 7.2.4 Bi-Amp [ext.FP+RP] (RX-V3083 only)

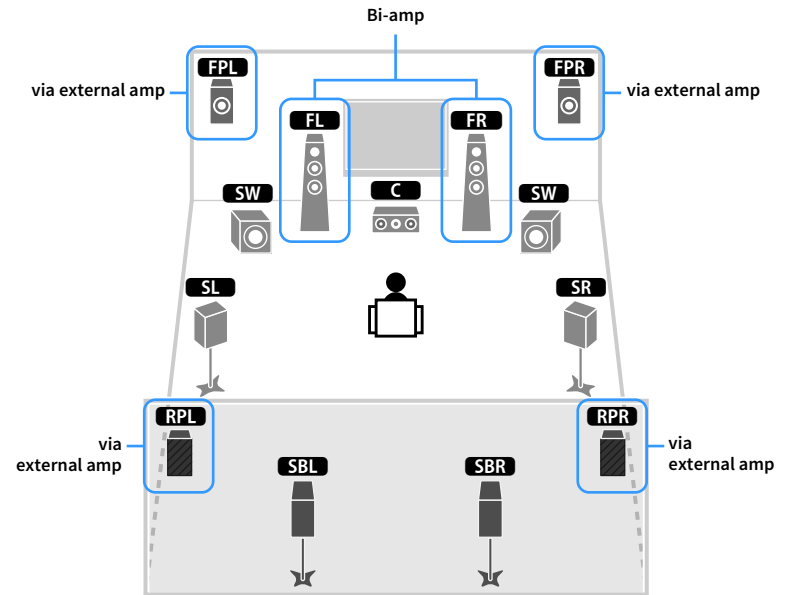

Speaker	Connect to
<b>FL</b> <b>FR</b>	FRONT and EXTRA SP 1 (bi-amp connection)
<b>C</b>	CENTER
<b>SL</b> <b>SR</b>	SURROUND
<b>SBL</b> <b>SBR</b>	SURROUND BACK
<b>FPL</b> <b>FPR</b>	(not used)
<b>RPL</b> <b>RPR</b>	(not used)
<b>SW</b>	SUBWOOFER 1-2
Zone2 speakers	EXTRA SP 2



When Zone2 output is enabled (p.114), the surround back speakers in the main zone do not output sound.

Speaker	Connect to
<b>FL</b> <b>FR</b>	FRONT and EXTRA SP 1 (bi-amp connection)
<b>C</b>	CENTER
<b>SL</b> <b>SR</b>	SURROUND
<b>SBL</b> <b>SBR</b>	SURROUND BACK
<b>FPL</b> <b>FPR</b>	F.PRESENCE (PRE OUT) via external power amplifier
<b>RPL</b> <b>RPR</b>	R.PRESENCE (PRE OUT) via external power amplifier
<b>SW</b>	SUBWOOFER 1-2



When this configuration is applied, you cannot utilize the ZONE OUT/PRE OUT jacks for connecting external amplifiers for Zone2 and Zone3 (p.111).

## 5.2.4 Bi-Amp [ext.RP] (RX-V3083 only)

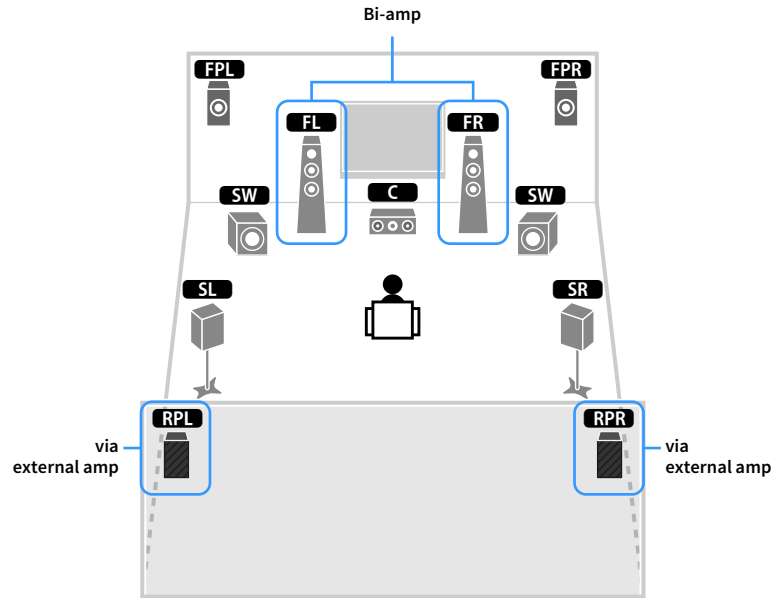

Speaker	Connect to
<b>FL</b> <b>FR</b>	FRONT and EXTRA SP 1 (bi-amp connection)
<b>C</b>	CENTER
<b>SL</b> <b>SR</b>	SURROUND
<b>SBL</b> <b>SBR</b>	(not used)
<b>FPL</b> <b>FPR</b>	EXTRA SP 2
<b>RPL</b> <b>RPR</b>	R.PRESENCE (PRE OUT) via external power amplifier
<b>SW</b>	SUBWOOFER 1-2



When this configuration is applied, you cannot utilize the ZONE OUT/PRE OUT jacks for connecting an external amplifier for Zone3 (p.111).

## ■ Connecting front speakers that support bi-amp connections

When using front speakers that support bi-amp connections, connect them to the FRONT terminals and EXTRA SP1 terminals.

To enable the bi-amp function, configure the “Power Amp Assign” setting in the “Setup” menu after connecting the power cable to an AC wall outlet (p.53).

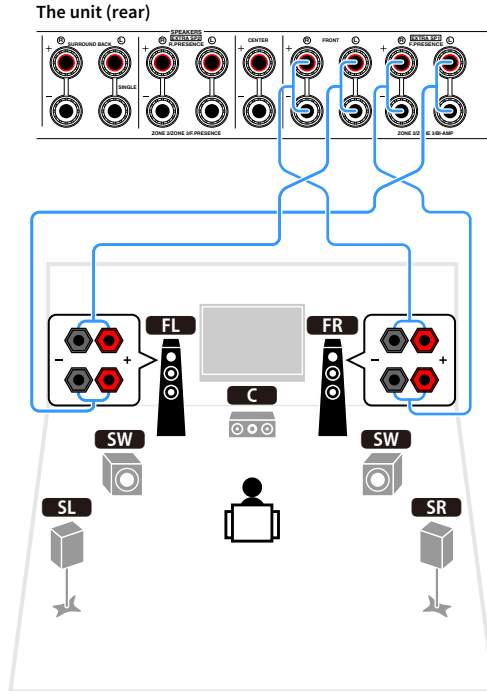

The FRONT terminals and EXTRA SP1 terminals output the same signals.

### Caution

Before making bi-amp connections, remove any brackets or cables that connect a woofer with a tweeter. Refer to the instruction manual of the speakers for details. If you are not making bi-amp connections, make sure that the brackets or cables are connected before connecting the speaker cables.

## ■ Connecting Zone2/3 speakers

When using Zone2/3 speakers, connect them to the EXTRA SP 1-2 terminals.

To utilize the EXTRA SP 1-2 terminals for Zone2/3 speakers, configure the “Power Amp Assign” setting in the “Setup” menu after connecting the power cable to an AC wall outlet (p.53).

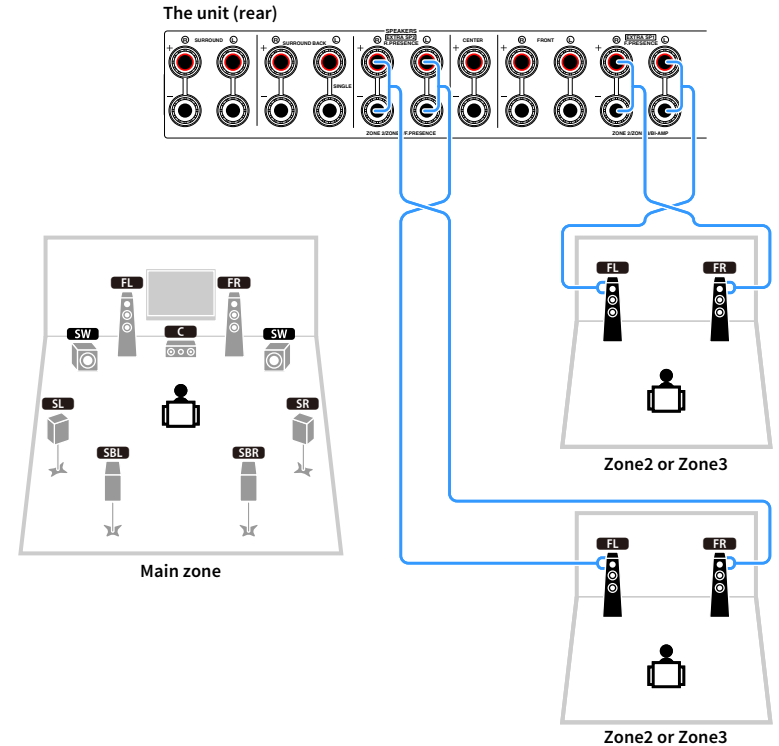

- You can select a zone (Zone2 or Zone3) to be assigned to the EXTRA SP 1-2 jacks in “Power Amp Assign” (p.140) in the “Setup” menu.
- You can also connect Zone2 and Zone3 speakers using an external amplifier (p.111).

## Connecting an external power amplifier

When connecting an external power amplifier to enhance speaker output, connect the input jacks of the power amplifier to the PRE OUT jacks of the unit. The same channel signals are output from the PRE OUT jacks as from their corresponding SPEAKERS terminals.

### Caution

- To prevent the generation of loud noises or abnormal sounds, make sure the followings before making connections.
  - Remove the power cable of the unit and turn off the external power amplifier before connecting them.
  - When using the PRE OUT jacks, do not connect speakers to the corresponding SPEAKERS terminals.
  - When using a pre-main amplifier that does not have the volume control bypass, turn up the volume of the pre-main amplifier enough and fix it. In this case, do not connect other devices (except the unit) to the pre-main amplifier.

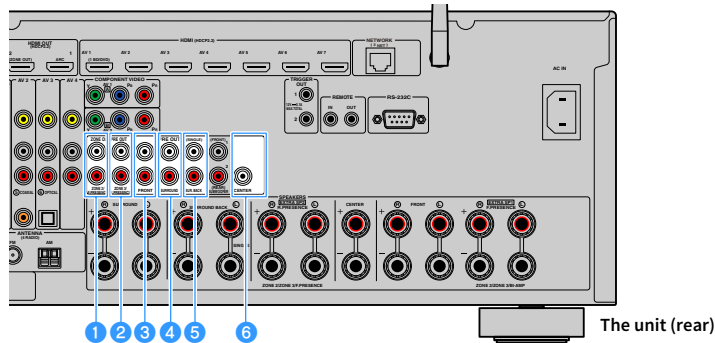

### 1 F.PRESENCE jacks (RX-V3083 only)

Output front presence channel audio signals or Zone2 audio signals depending on the “Power Amp Assign” setting (p.140).

### 2 R.PRESENCE jacks (RX-V3083 only)

Output rear presence channel audio signals or Zone3 audio signals depending on the “Power Amp Assign” setting (p.140).

### 3 FRONT jacks

Output front channel sounds.

### 4 SURROUND jacks

Output surround channel sounds.

### 5 SUR. BACK jacks

Output surround back channel sounds. When using only one surround back speaker, connect the external amplifier to the SINGLE jack (L side).

### 6 CENTER jack

Outputs center channel sounds.

### (Example)

Connecting front speakers via an external power amplifier

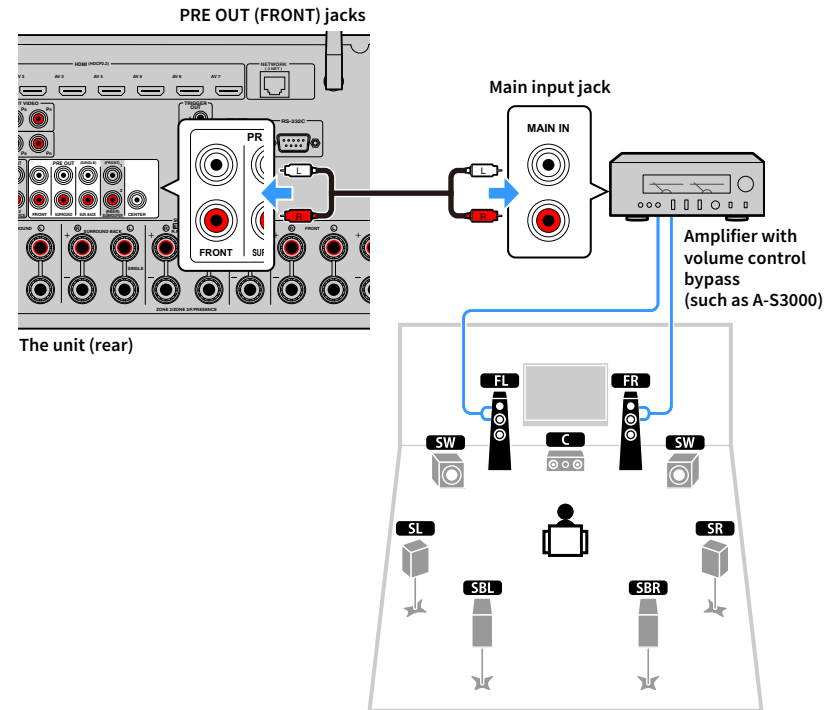

### About external power amplifiers

We recommend using power amplifiers that meet the following conditions.

- With unbalanced inputs
- With volume control bypass (or without volume control circuit)
- Output power: 100 W or more (6 to 8 Ω)



## 2 Connecting a TV and playback devices

Connect a TV and playback devices (video and audio devices) to the unit.

For information on how to connect a USB storage device, see “Connecting a USB storage device” (p.97).

### Input/output jacks and cables

The unit is equipped with the following input/output jacks. Prepare the cables that match the jacks on your devices.

#### Video/audio jacks

To input/output video and audio signals, use the following jacks.

##### HDMI jacks

Transmit digital video and digital sound through a single jack. Use an HDMI cable.

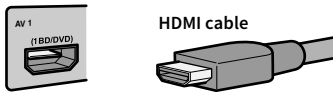

Use a 19-pin HDMI cable with the HDMI logo. We recommend using a cable less than 5.0 m (16.4 ft) long to prevent signal quality degradation.



- The unit's HDMI jacks support the HDMI Control, Audio Return Channel (ARC), and 3D and 4K Ultra HD video transmission features.
- Use high speed HDMI cables to enjoy 3D or 4K Ultra HD videos.

#### Video jacks

To input only video signals, use the following jacks.

##### COMPONENT VIDEO jacks

Transmit video signals separated into three components: luminance (Y), chrominance blue (Pb), and chrominance red (Pr). Use a component video cable with three plugs.

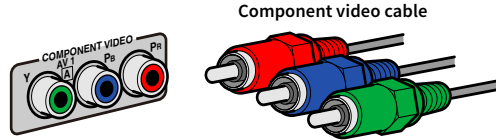

##### VIDEO jacks

Transmit analog video signals. Use a video pin cable.

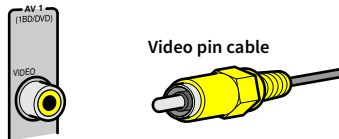

#### Audio jacks

To input/output only audio signals, use the following jacks.

##### OPTICAL jacks

Transmit digital audio signals. Use a digital optical cable. Remove the tip protector (if available) before using the cable.

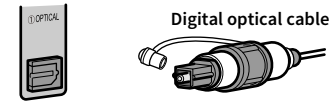

##### COAXIAL jacks

Transmit digital audio signals. Use a digital coaxial cable.



##### AUDIO jacks

Transmit analog stereo audio signals. Use a stereo pin cable (RCA cable).

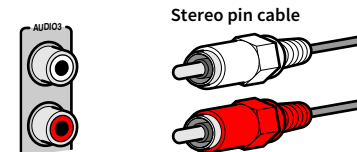

## XLR jacks

Transmit analog audio signals. Use an XLR balanced cable. Match the pins and insert the “male” connector of the XLR balanced cable until you hear a click.

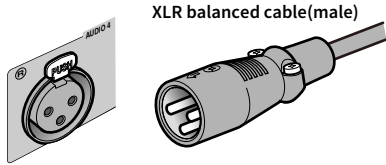

When disconnecting the cable from the unit, hold down the PUSH button on the unit and then pull the connector out.

### About the XLR jacks

The pin assignments for the XLR jacks of the unit are shown below. Before connecting an XLR balanced cable, refer to the instruction manual of your device and verify that its XLR jacks are compatible with the pin assignments.

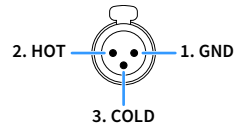

## Connecting a TV

Connect a TV to the unit so that video input to the unit can be output to the TV.

You can also enjoy playback of TV audio on the unit.

### HDMI connection

Connect the TV to the unit with an HDMI cable and an audio cable (digital optical or stereo pin cable).



You can connect another TV or a projector by using the HDMI OUT 2 jack (p.44).

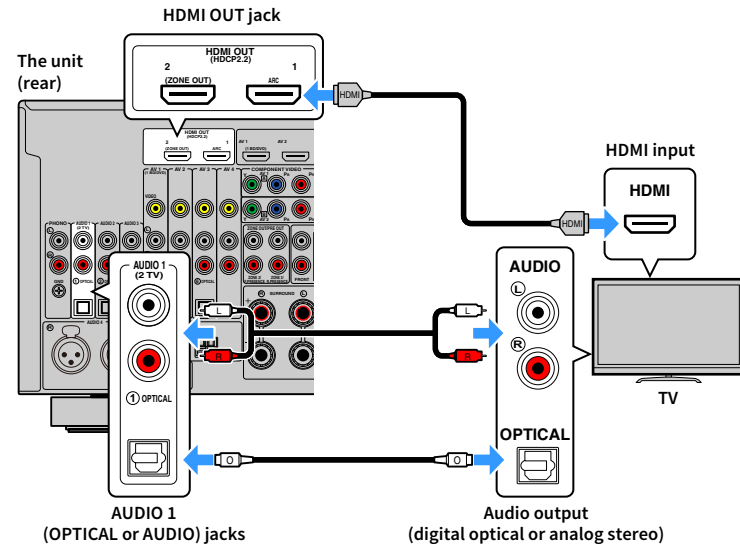

You do not make an audio cable connection between the TV and the unit in the following cases:

- If your TV supports Audio Return Channel (ARC)
- If you will receive TV broadcasts only from the set-top box
- If you connect a TV that supports HDMI Control to the unit with an HDMI cable, you can control the unit's power and volume with the TV's remote control.

To use HDMI Control and ARC, you need to configure the HDMI settings on the unit. For details on the settings, see "Information on HDMI" (p.188).

#### About Audio Return Channel (ARC)

- ARC allows audio signals to travel both ways. If you connect a TV that supports ARC to the unit with a single HDMI cable, you can output video/audio to the TV or input TV audio to the unit.
- When using ARC, connect a TV with an HDMI cable that supports ARC.

## Connecting another TV or a projector

The unit has two HDMI output jacks. If you connect another TV or a projector to the unit with an HDMI cable, you can switch the TV (or projector) to be used for watching videos with the remote control (p.75).

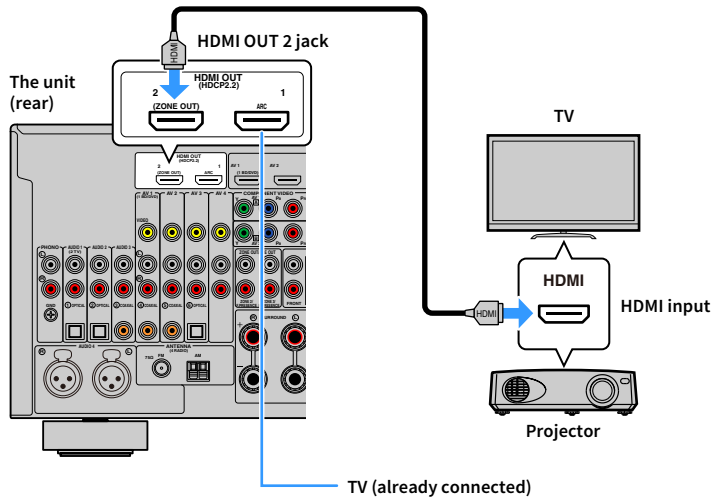

- HDMI Control is not available on the HDMI OUT 2 jack.
- If you set “HDMI OUT2 Assign” (p.155) in the “Setup” menu to “Zone2” or “Zone4”, you can connect a video monitor for Zone2 or Zone4 to the HDMI OUT 2 jack and enjoy videos and audio using the video monitor (p.112).

## Connecting video devices (such as BD/DVD players)

Connect video devices such as BD/DVD players, set-top boxes (STBs) and game consoles to the unit. Depending on the video/audio output jacks available on your video device, choose one of the following connections. We recommend using an HDMI connection if the video device has an HDMI output jack.



The following explanation is based on the assumption that you have not changed the “Input Assignment” setting (p.156) in the “Setup” menu. As necessary, you can assign the COMPONENT VIDEO (A, B), COAXIAL (C, D, E) and OPTICAL (F, G, H) jacks to another input source.



If you make more than one audio connection for one input source, an audio signal played back on the unit will be determined according to the “Audio Select” setting (p.126) in the “Option” menu.

## HDMI connection

Connect a video device to the unit with an HDMI cable.

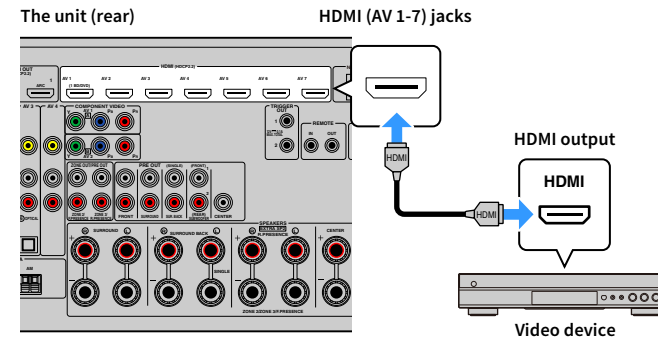

If you select the input source by pressing AV 1-7 on the remote control, the video/audio played back on the video device will be output from the unit.

## ■ Component video connection

Connect a video device to the unit with a component video cable and an audio cable (digital coaxial or stereo pin cable). Choose a set of input jacks (on the unit) depending on the audio output jacks available on your video device.

Output jacks on video device		Input jacks on the unit
Video	Audio	
Component video	Digital coaxial	AV 1-2 (COMPONENT VIDEO + COAXIAL)
	Analog stereo	AV 1-2 (COMPONENT VIDEO + AUDIO)

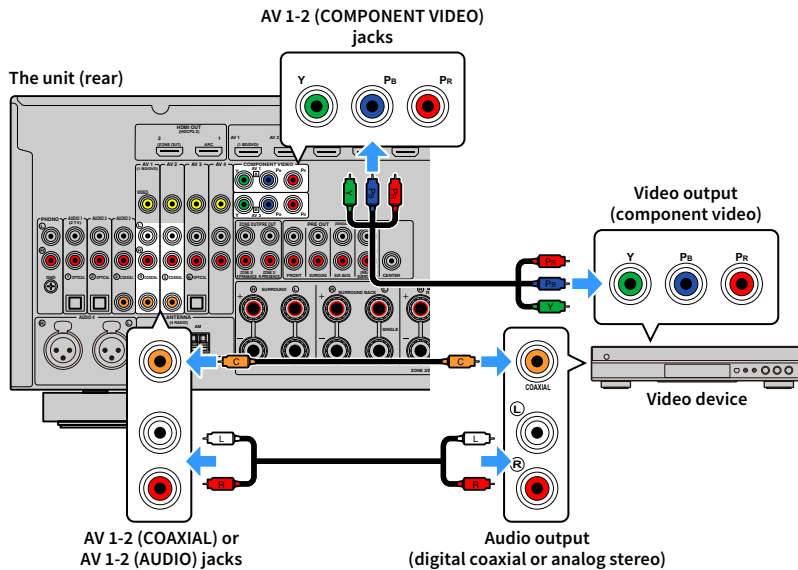

If you select the input source by pressing AV 1-2 on the remote control, the video/audio played back on the video device will be output from the unit.



To connect a video device to the unit with a component video cable and a digital optical cable, use “Input Assignment” (p.156) in the “Setup” menu to assign the COMPONENT VIDEO and OPTICAL jacks to the same input source.

## ■ Composite video connection

Connect a video device to the unit with a video pin cable and an audio cable (digital coaxial, digital optical, or stereo pin cable). Choose a set of input jacks (on the unit) depending on the audio output jacks available on your video device.

Output jacks on video device		Input jacks on the unit
Video	Audio	
Composite video	Digital coaxial	AV 1-2 (VIDEO + COAXIAL)
	Digital optical	AV 3 (VIDEO + OPTICAL)
	Analog stereo	AV 1-4 (VIDEO + AUDIO)

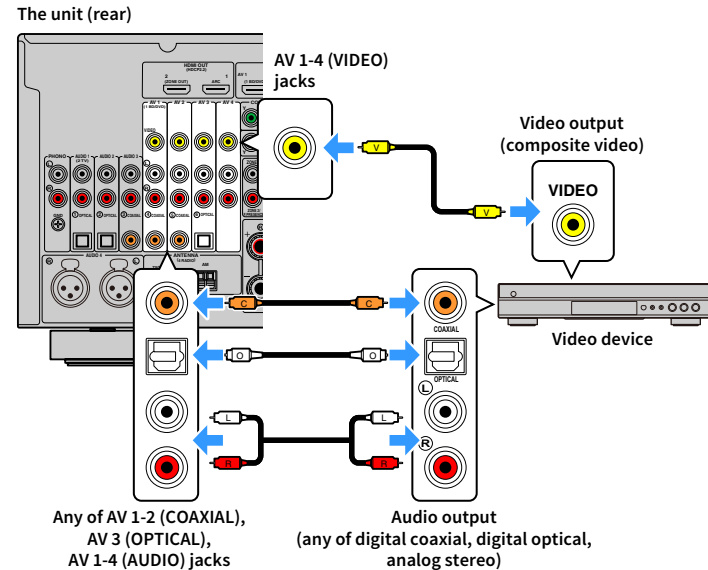

If you select the input source by pressing AV 1-4 on the remote control, the video/audio played back on the video device will be output from the unit.

## Connecting audio devices (such as CD players)

Connect audio devices such as CD players and a turntable to the unit. Depending on the audio output jacks available on your audio device, choose one of the following connections.



- The following explanation is based on the assumption that you have not changed the “Input Assignment” setting (p.156) in the “Setup” menu. As necessary, you can assign the COAXIAL (Ⓢ, Ⓣ, Ⓤ) and OPTICAL (Ⓛ, Ⓜ, Ⓨ) jacks to another input source.
- (RX-V3083 only)  
Before connecting XLR balanced cables, refer to the instruction manual of your audio device and verify that its XLR jacks are compatible with the pin assignments of the unit (p.42).



If you make more than one audio connection for one input source, an audio signal played back on the unit will be determined according to the “Audio Select” setting (p.126) in the “Option” menu.

Audio output jacks on audio device	Audio input jacks on the unit
Digital coaxial	AV 1-2 (COAXIAL) AUDIO 3 (COAXIAL)
Digital optical	AV 3 (OPTICAL) AUDIO 1-2 (OPTICAL)
Analog stereo (RCA)	AV 1-4 (AUDIO [RCA]) AUDIO 1-3 (AUDIO [RCA])
Analog stereo (XLR)	AUDIO 4 (AUDIO [XLR]) (RX-V3083 only)
Turntable (PHONO)	PHONO

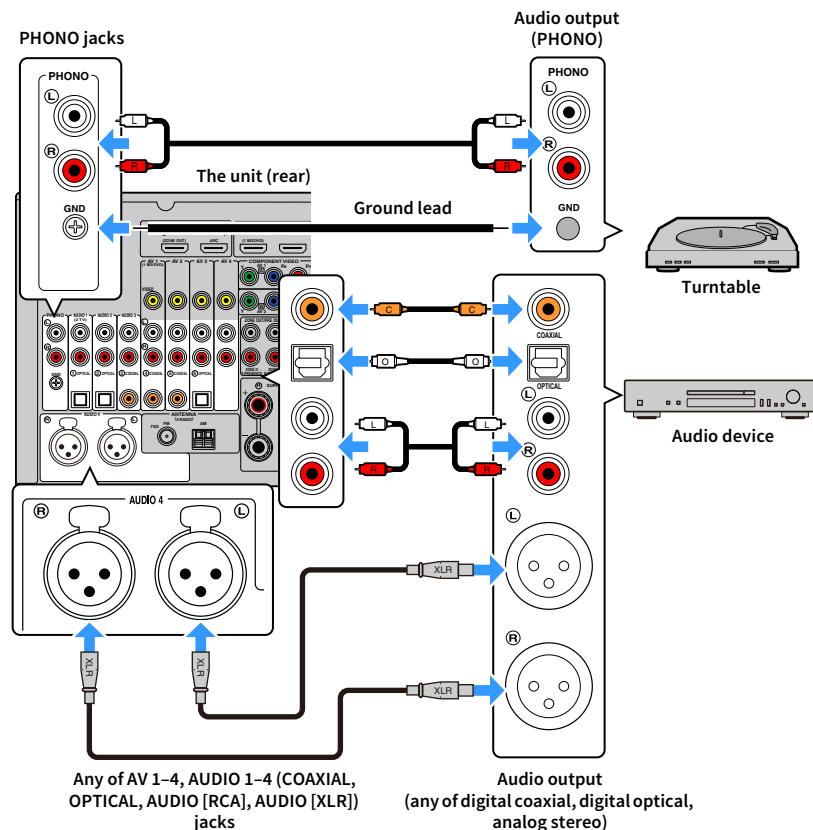

If you select the input source by pressing AV 1-4, AUDIO 1-4 or PHONO on the remote control, the audio played back on the audio device will be output from the unit.

\* AUDIO 4 (AUDIO [XLR]) jack: RX-V3083 only

### When connecting a turntable

- The PHONO jack of the unit is compatible with an MM cartridge. To connect a turntable with a low-output MC cartridge, use a boosting transformer.
- Connecting the turntable to the GND terminal of the unit may reduce noise in the signal.

## Connecting to the jacks on the front panel

Use the VIDEO AUX jack to temporarily connect a playback device to the unit.

Use the USB jack to connect a USB storage device. For details, see “Connecting a USB storage device” (p.97).

Before making a connection, stop playback on the device and turn down the volume on the unit.

### ■ HDMI connection

Connect an HDMI-compatible device (such as game consoles and camcorders) to the unit with an HDMI cable.

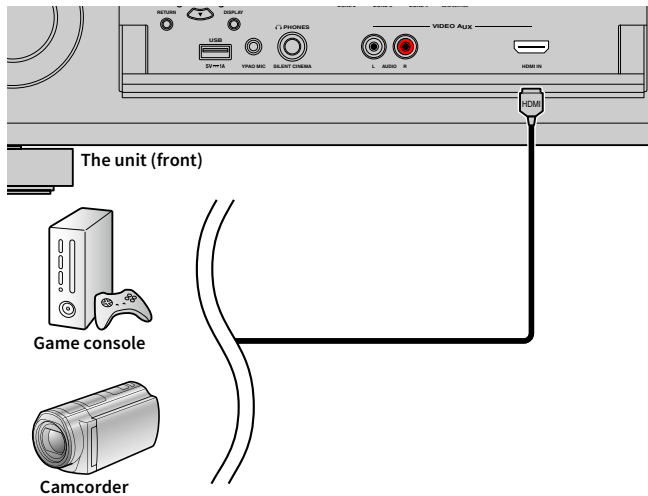

If you select “VIDEO AUX” as the input source by pressing V-AUX on the remote control, the video/audio played back on the device will be output from the unit.



- You need to prepare an HDMI cable that matches the output jacks on your device.
- The VIDEO AUX (HDMI IN) jack does not support HDCP 2.2.

### ■ Analog stereo connection

Connect a playback device (such as CD players) to the unit with a stereo pin cable.

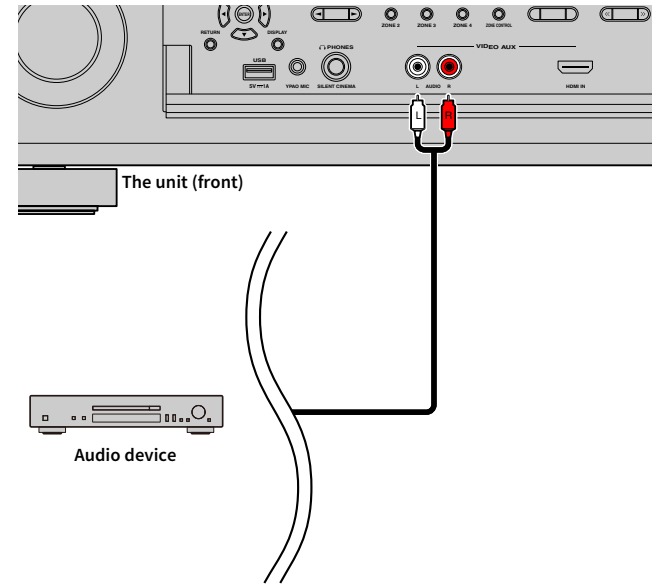

If you select “VIDEO AUX” as the input source by pressing V-AUX, the audio played back on the device will be output from the unit.



If you connect devices to both the VIDEO AUX (HDMI IN) jack and VIDEO AUX (AUDIO) jacks, the unit outputs audio input through the VIDEO AUX (HDMI IN) jack.

### 3 Connecting the radio antennas

Connect the supplied radio antenna to the unit.

#### FM/AM antennas (China model only)

Connect the supplied FM/AM antennas to the unit.

Fix the end of the FM antenna to a wall, and place the AM antenna on a flat surface.

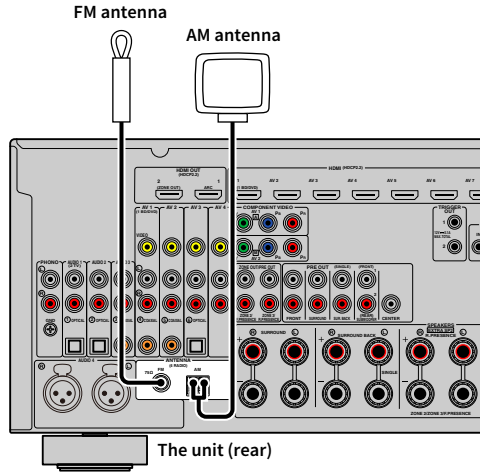

#### Assembling the AM antenna

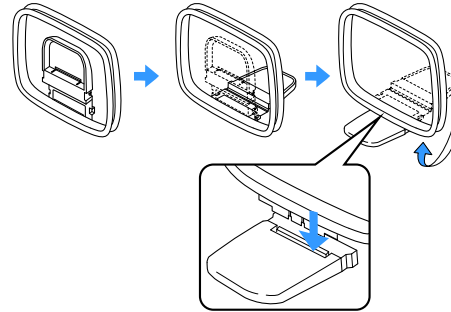

#### Connecting the AM antenna

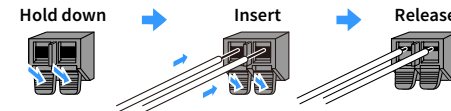

- Unwind only the length of cable needed from the AM antenna unit.
- The wires of the AM antenna have no polarity.



## DAB/FM antenna (Australia model only)

Connect the supplied DAB/FM antenna to the unit and fix the antenna ends to a wall.

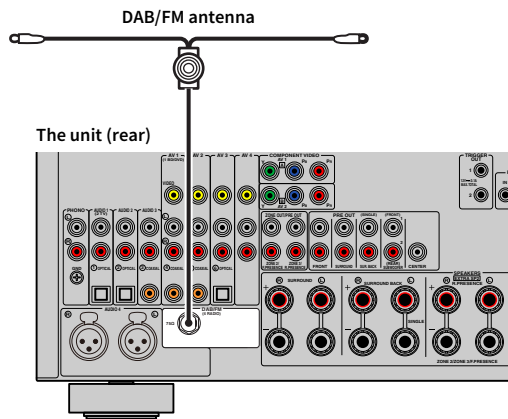

- The antenna should be stretched out horizontally.
- If you cannot obtain good reception on the radio, adjust the height, direction or placement of the DAB/FM antenna.

## 4 Connecting a network cable or preparing the wireless antenna

Connect the unit to a router (access point) with a network cable, or prepare the wireless antenna for establishing a wireless network connection.

You can enjoy Internet radio or music files stored on media servers, such as PCs and Network Attached Storage (NAS), on the unit.

### Connecting the network cable

Connect the unit to your router with a commercially-available STP network cable (CAT-5 or higher straight cable).

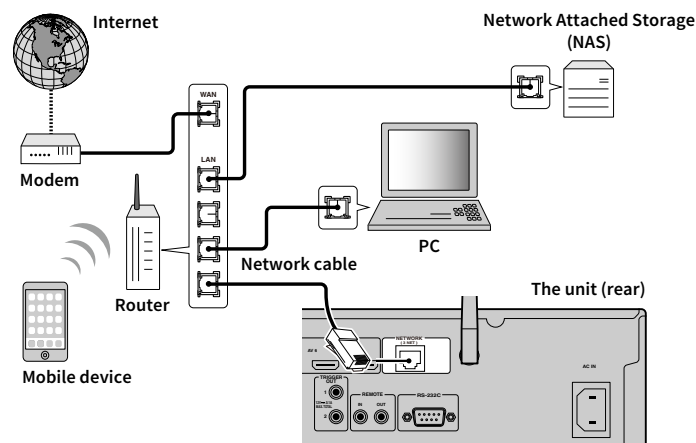

- If you want to use a wired (network cable) connection when a wireless connection has been made, set “Network Connection” (p.150) in the “Setup” menu to “Wired”.
- If you are using a router that supports DHCP, you do not need to configure any network settings for the unit, as the network parameters (such as the IP address) will be assigned automatically to it. You only need to configure the network settings if your router does not support DHCP or if you want to configure the network parameters manually (p.150).
- You can check whether the network parameters (such as IP address) are properly assigned to the unit in “Network” (p.160) in the “Information” menu.



- Some security software installed on your PC or the firewall settings of network devices (such as a router) may block the access of the unit to the network devices or the Internet. In these cases, configure the security software or firewall settings appropriately.
- Each server must be connected to the same subnet as the unit.
- To use the service via the Internet, broadband connection is strongly recommended.

### Preparing the wireless antenna

If you want to establish a wireless network connection, stand the wireless antenna up straight.

For information on how to connect the unit to a network device wirelessly, see “Connecting to a network device wirelessly” (p.66).

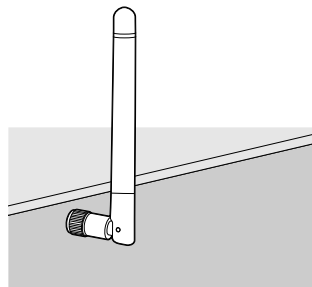

Do not apply excessive force on the antenna. Doing so may damage it.

## 5 Connecting other devices

Connect a device compatible with the trigger function.

### Connecting a device compatible with the trigger function

The trigger function can control an external device in conjunction with operating the unit (such as powering on/off and input selection). If you have a Yamaha subwoofer that supports a system connection or a device with a trigger input jack, you can use the trigger function by connecting the external device to one of the TRIGGER OUT jacks with a monaural mini-plug cable.

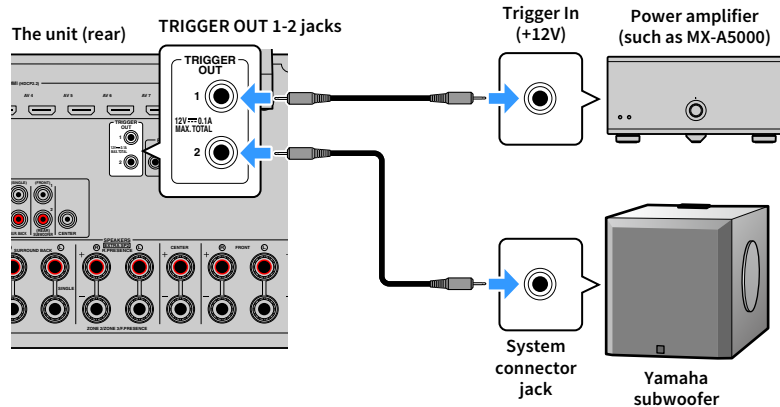

You can configure the trigger function settings in “Trigger Output1” and “Trigger Output2” (p.157) in the “Setup” menu.

## 6 Connecting the power cable

After all the connections are complete, connect the supplied power cable to the unit and then to an AC wall outlet.

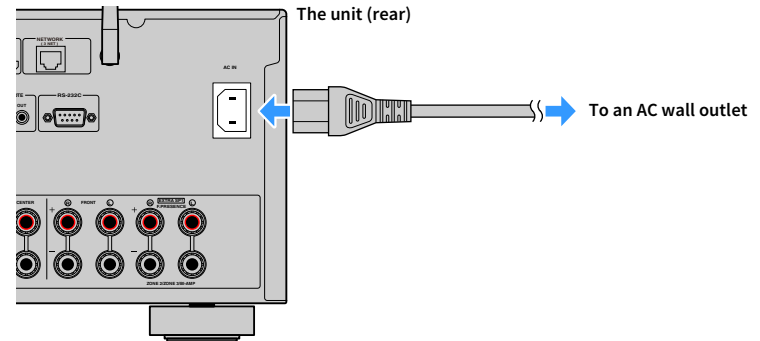

## 7 Selecting an on-screen menu language

Select the desired on-screen menu language from English, Japanese, French, German, Spanish, Russian, Italian and Chinese.





- 1 Press RECEIVER  to turn on the unit.
- 2 Turn on the TV and switch the TV input to display video from the unit.

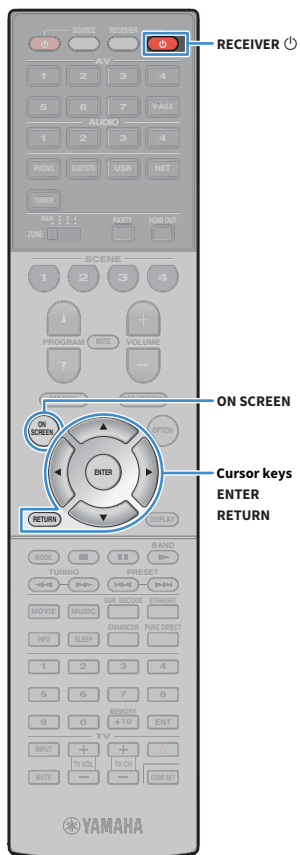
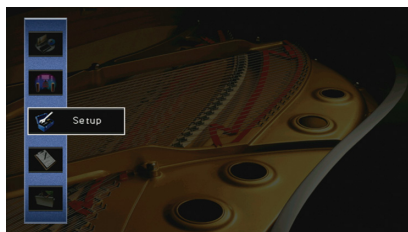

If you turn on the unit for the first time, the message regarding the network setup appears. For now, press RETURN and proceed to Step 3.

- 3 Press ON SCREEN.
- 4 Use the cursor keys to select “Setup” and press ENTER.



- 5 Use the cursor keys (/ ) to select “Language” and the cursor keys (/ ) to select the desired language.



- 6 To confirm the setting, press ENTER.

- 7 To exit from the menu, press ON SCREEN.



The information on the front display is provided in English only.

## 8 Configuring the necessary speaker settings

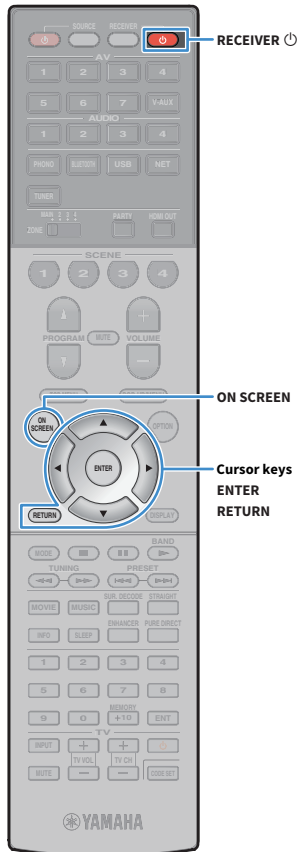

If you use any of the following speaker configurations, follow the procedure below to configure the corresponding speaker settings manually before performing YPAO.

- Advanced speaker configuration (p.30)
- Using the surround speakers for front 5.1-channel system (Virtual CINEMA FRONT) (p.24)
- Using the presence speakers for Dolby Atmos or DTS:X playback (p.26)

- 1** Press **RECEIVER** to turn on the unit.
- 2** Turn on the TV and switch the TV input to display video from the unit (HDMI OUT jack).



If you turn on the unit for the first time, the message regarding the network setup appears. For now, press RETURN and proceed to Step 3.

- 3** Press **ON SCREEN**.
- 4** Use the cursor keys to select “Setup” and press **ENTER**.
- 5** Use the cursor keys and **ENTER** to select “Speaker” and then “Manual Setup”.

### 6 Configure the corresponding speaker settings.

- When using any of advanced speaker configurations, select “Power Amp Assign” (p.140), then select your speaker system.
- When using the surround speakers for front 5.1-channel system (Virtual CINEMA FRONT), select “Configuration” → “Layout” → “Surround” (p.141), then select “Front”.
- When using the presence speakers for Dolby Atmos or DTS:X playback, select “Configuration” → “Layout” → “Front Presence” (p.142), then select your front presence speaker layout.

If you are using the rear presence speakers, also select its layout in “Rear Presence”.

### 7 To exit from the menu, press **ON SCREEN**.

## 9 Optimizing the speaker settings automatically (YPAO)

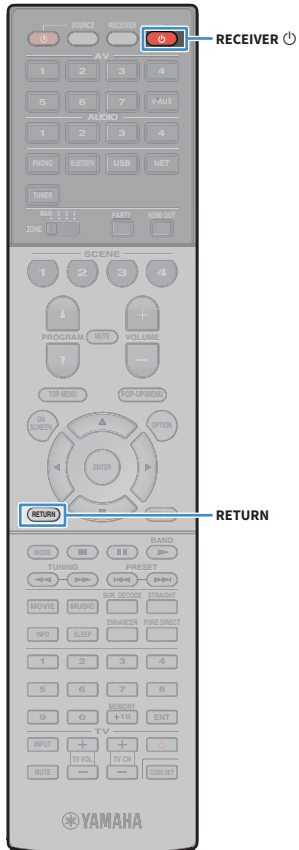

The Yamaha Parametric room Acoustic Optimizer (YPAO) function detects speaker connections, measures the distances from them to your listening position(s), and then automatically optimizes the speaker settings, such as volume balance and acoustic parameters, to suit your room.



The YPAO function of the unit adopts the YPAO-R.S.C. (Reflected Sound Control) technology that enables to create natural sound fields like a room specifically designed for acoustic perfection.



Note the following regarding YPAO measurement.

- Test tones are output at high volume and may surprise or frighten small children.
- Test tone volume cannot be adjusted.
- Keep the room as quiet as possible.
- Stay in a corner of the room behind the listening position so that you do not become an obstacle between speakers and the YPAO microphone.
- Do not connect headphones.

- 1 Press RECEIVER to turn on the unit.
- 2 Turn on the TV and switch the TV input to display video from the unit.
  - If you turn on the unit for the first time, the message regarding the network setup appears. For now, press RETURN and proceed to Step 3.
- 3 Turn on the subwoofer and set the volume to half. If the crossover frequency is adjustable, set it to maximum.

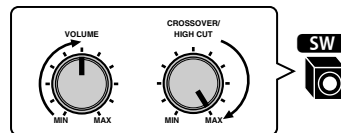

- 4 Place the YPAO microphone at your listening position and connect it to the YPAO MIC jack on the front panel.



Place the YPAO microphone at your listening position (same height as your ears). We recommend the use of a tripod as a microphone stand. You can use the tripod screws to stabilize the microphone.

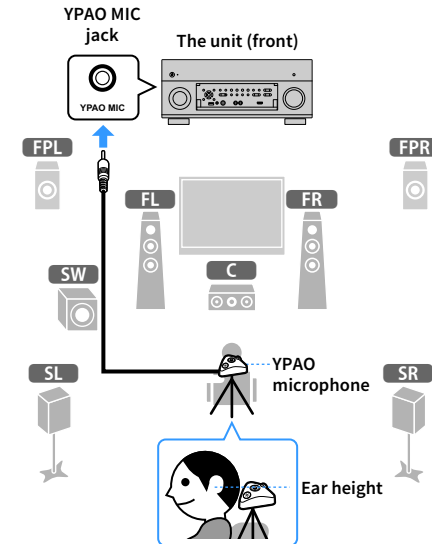

The following screen appears on the TV.

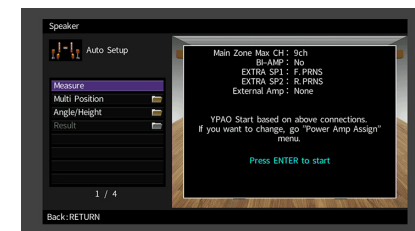

To cancel the operation, disconnect the YPAO microphone before starting the measurement.

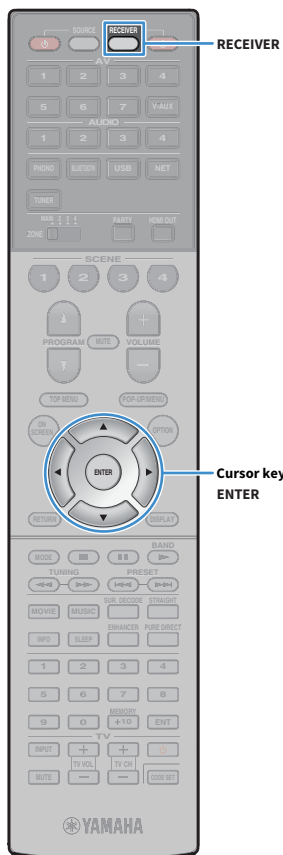

## 5 If desired, select the measuring options.

1 Use the cursor keys to select “Multi Position” (p.56) or “Angle/Height” (p.57) and press ENTER.

2 Use the cursor keys to select a setting and then press ENTER.



If the cursor keys do not work, the remote control may be set to operate external devices. In this case, press RECEIVER and then use the cursor keys.

This completes the preparations. See the following page to start the measurement.

### When “Multi Position” is set to “Yes”:

“Measuring at multiple listening positions (multi measure)” (p.60)

### When “Multi Position” is set to “No”:

“Measuring at one listening position (single measure)” (p.57)

# Multi Position

Selects multi measure or single measure.

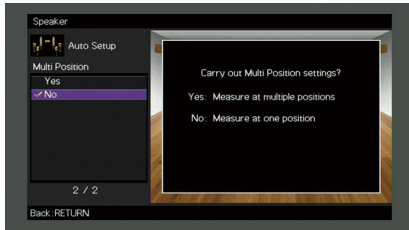

## Settings

Yes	Select this option if you will have several listening positions or if you want others to enjoy surround sound. You can take measurements at up to 8 different positions in the room. The speaker settings will be optimized to suit the area defined by those positions (multi measure).
No (default)	Select this option if your listening position will always be fixed. Take the measurements at only one position. The speaker settings will be optimized to suit that position (single measure).



- If you perform the multi measure, the speaker settings will be optimized for you to enjoy surround sound in a wider space.
- If you perform the multi measure, first place the YPAO microphone at the listening position you will be seated most frequently.

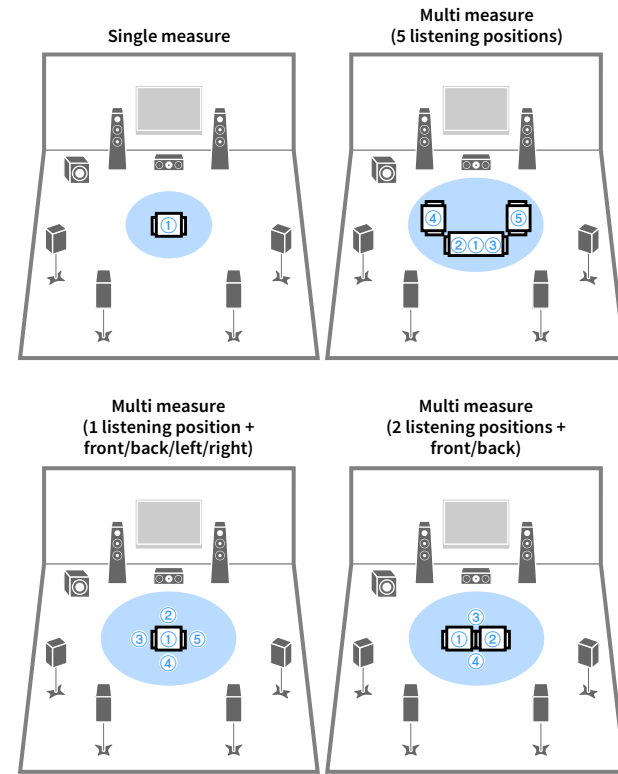



## Angle/Height

Enables/disables the angle/height measurement.

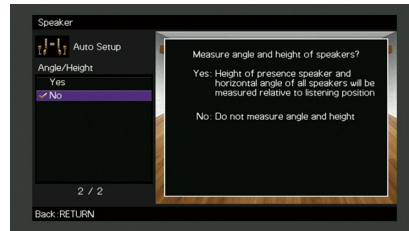

### Settings

Yes	Enables the angle/height measurement. The unit will measure angle of each speaker and height of the presence speakers at the listening position, and correct the speaker parameters so that CINEMA DSP can create more effective sound fields.
No (default)	Disables the angle/height measurement.

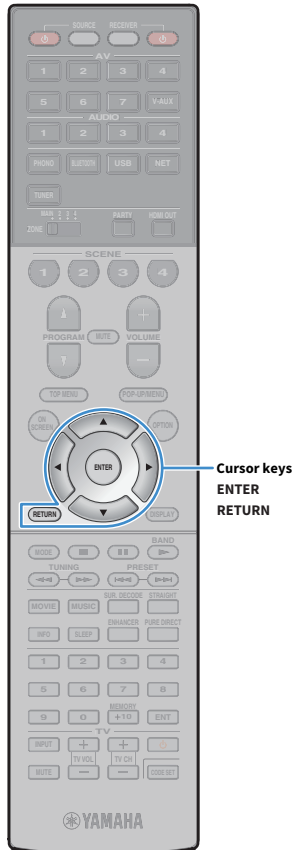

Cursor keys  
ENTER  
RETURN

## Measuring at one listening position (single measure)

When “Multi Position” is set to “No”, follow the procedure below for measurement. It takes about 5 minutes to perform the measurement.



- If any error message (such as E-1) or warning message (such as W-1) appears, see “Error messages” (p.64) or “Warning messages” (p.65).
- Do not use the microphone base until the corresponding message appear on the TV.

### 1 To start the measurement, use the cursor keys to select “Measure” and press ENTER.

The measurement will start in 10 seconds. Press ENTER again to start the measurement immediately.



To cancel the measurement temporarily, press RETURN.

The following screen appears on the TV when the measurement finishes.

### (when angle/height measurement is disabled)

Proceed to Step 3.



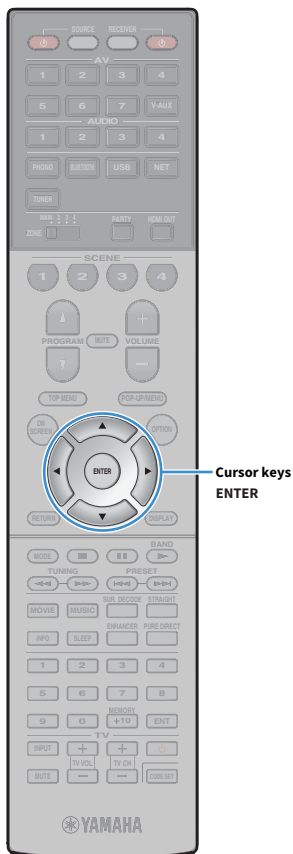

**(when angle/height measurement is enabled)**

Proceed to Step 2.



## 2 Perform the angle/height measurement.

- 1 Use the cursor keys to select "YES" and press ENTER. Select "NO" to cancel the angle/height measurement.
- 2 Attach the supplied pole to the center of the microphone base.

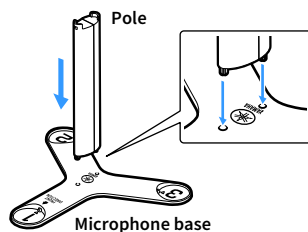

- 3 Place the microphone base at the listening position and set the YPAO microphone to the position "1".

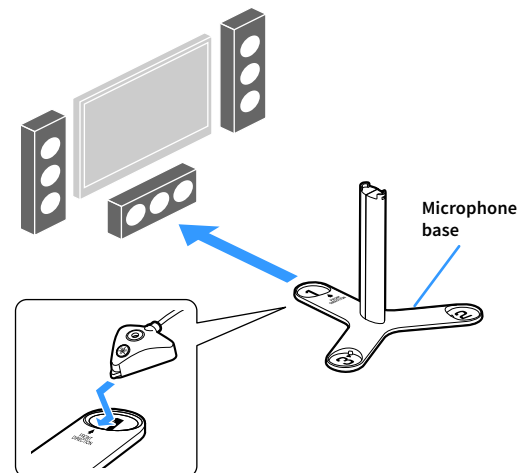

- We recommend using a tripod to place the microphone base at ear height. Use the tripod screws to fix the microphone base in place.
- Do not move the microphone base until the fourth angle measurement finishes.

- 4 Press ENTER to start the first angle measurement.

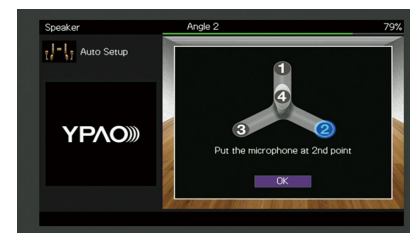

- 5 In the same way, perform the angle measurement for the positions "2" and "3".



Cursor keys  
ENTER

- 6** Set the YPAO microphone at the top of the pole and perform the fourth angle measurement.

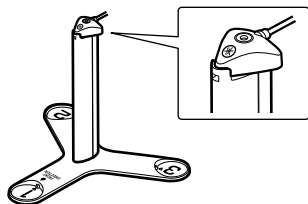

The following screen appears on the TV when the fourth angle measurement finishes.



- 3** Use the cursor keys to select “Save/Cancel” and press ENTER.



To check the measurement results, select “Result”. For details, see “Checking the measurement results” (p.63).

- 4** To save the measurement results, use the cursor keys (◀/▶) to select “SAVE” and press ENTER.



The adjusted speaker settings are applied.



To finish the measurement without saving the result, select “CANCEL”.

- 5** Use the cursor keys (◀/▶) to select “YES” or “NO” to enable/disable YPAO Volume and press ENTER.

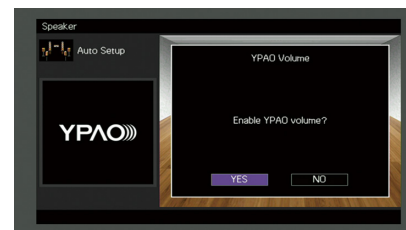

- If YPAO Volume is enabled, the high- and low-frequency levels are automatically adjusted according to the volume so that you can enjoy natural sounds even at low volume.
- You can also enable/disable YPAO Volume in “YPAO Volume” (p.123) in the “Option” menu.

- 6** Disconnect the YPAO microphone from the unit.

This completes optimization of the speaker settings.

**Caution**

The YPAO microphone is sensitive to heat, so should not be placed anywhere where it could be exposed to direct sunlight or high temperatures (such as on top of AV equipment).

## Measuring at multiple listening positions (multi measure)

When “Multi Position” is set to “Yes”, follow the procedure below for measurement. It takes about 15 minutes to measure 8 listening positions.



- If any error message (such as E-1) or warning message (such as W-1) appears, see “Error messages” (p.64) or “Warning messages” (p.65).
- Do not use the microphone base until the corresponding message appear on the TV.

### 1 To start the measurement, use the cursor keys to select “Measure” and press ENTER.

The measurement will start in 10 seconds. Press ENTER again to start the measurement immediately.



To cancel the measurement temporarily, press RETURN.

The following screen appears on the TV when the measurement at the first position finishes.

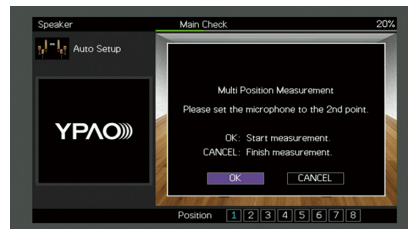

### 2 Move the YPAO microphone to the next listening position and press ENTER.

Repeat step 2 until measurements at all listening positions (up to 8) have been taken.

### 3 When the measurements at the positions you want to measure are completed, use the cursor keys to select “CANCEL” and press ENTER.

When you have taken measurements at 8 listening positions, the following screen appears automatically.

(when angle/height measurement is disabled)

Proceed to Step 5.



(when angle/height measurement is enabled)

Proceed to Step 4.

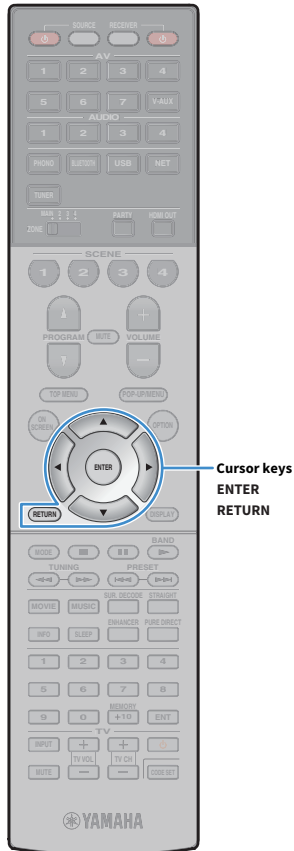

Cursor keys  
ENTER  
RETURN



Cursor keys  
ENTER

#### 4 Perform the angle/height measurement.

**1** Use the cursor keys to select “YES” and press ENTER.  
Select “NO” to cancel the angle/height measurement.

**2** Attach the supplied pole to the center of the microphone base.

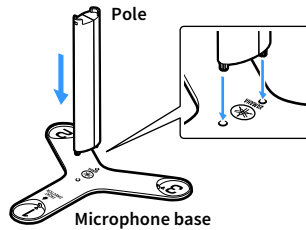

**3** Place the microphone base at the listening position you will be seated most frequently and set the YPAO microphone to the position “1”.

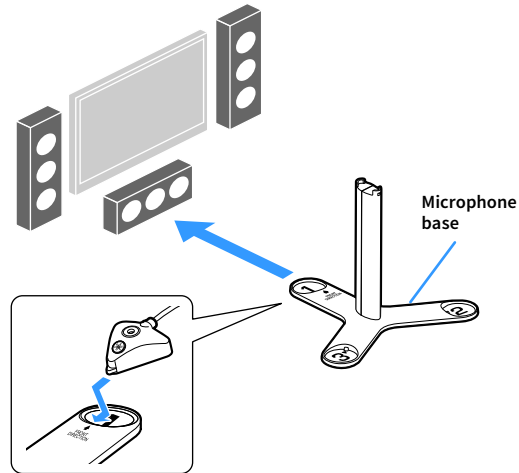

- We recommend using a tripod to place the microphone base at ear height. Use the tripod screws to fix the microphone base in place.
- Do not move the microphone base until the fourth angle measurement finishes.

**4** Press ENTER to start the first angle measurement.

The following screen appears on the TV when the first angle measurement finishes.

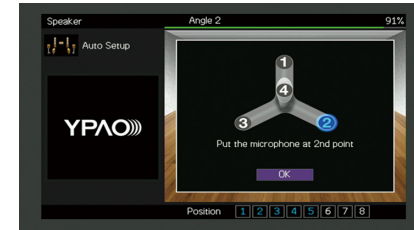

**5** In the same way, perform the angle measurement for the positions “2” and “3”.

**6** Set the YPAO microphone at the top of the pole and perform the fourth angle measurement.

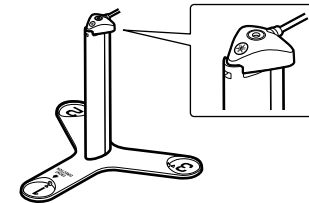

The following screen appears on the TV when the fourth angle measurement finishes.



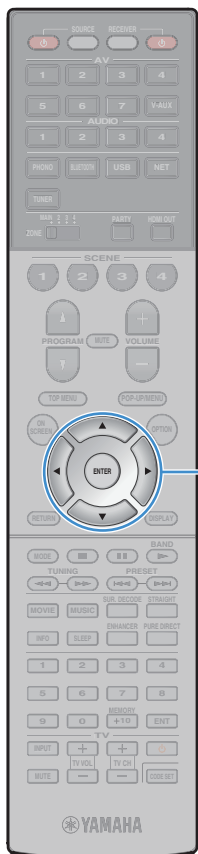

Cursor keys  
ENTER

- 5 Use the cursor keys to select “Save/Cancel” and press ENTER.



To check the measurement results, select “Result”. For details, see “Checking the measurement results” (p.63).

- 6 To save the measurement result, use the cursor keys to select “SAVE” and press ENTER.



The adjusted speaker settings are applied.



To finish the measurement without saving the result, select “CANCEL”.

- 7 Use the cursor keys (◀/▶) to select “YES” or “NO” to enable/disable YPAO Volume and press ENTER.

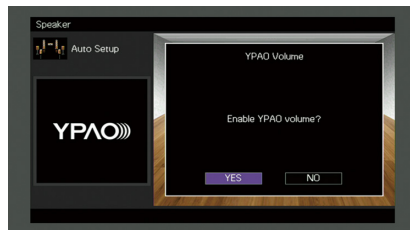

- If YPAO Volume is enabled, the high- and low-frequency levels are automatically adjusted according to the volume so that you can enjoy natural sounds even at low volume.
- You can also enable/disable YPAO Volume in “YPAO Volume” (p.123) in the “Option” menu.

- 8 Disconnect the YPAO microphone from the unit.

This completes optimization of the speaker settings.

#### Caution

The YPAO microphone is sensitive to heat, so should not be placed anywhere where it could be exposed to direct sunlight or high temperatures (such as on top of AV equipment).

## Checking the measurement results

You can check the YPAO measurement results.

- 1 After the measurement, use the cursor keys to select “Result” and press ENTER.



You can also select “Result” from “Auto Setup” (p.137) in the “Setup” menu, which displays the previous measurement results.

The following screen appears.



- 1 Measurement result items
- 2 Measurement result details
- 3 The number of measured positions (when multi measure is performed)

- 2 Use the cursor keys to select an item.

<b>Wiring</b>	Polarity of each speaker <b>Reverse:</b> The speaker cable may be connected with the reverse polarity (+/-).
---------------	---

<b>Size</b>	Size of each speaker (cross-over frequency of the subwoofer) <b>Large:</b> The speaker can reproduce low-frequency signals effectively. <b>Small:</b> The speaker cannot reproduce low-frequency signals effectively.
-------------	---

<b>Distance</b>	Distance from the listening position to each speaker
-----------------	--

<b>Level</b>	Output level adjustment for each speaker
--------------	--

<b>Angle (Horizontal)</b>	Horizontal angle of each speaker at the listening position
<b>Height</b>	Height of the presence speakers above the level of the listening position

- 3 To finish checking the results and return to the previous screen, press RETURN.

## Reloading the previous YPAO adjustments

When the speaker settings you have configured manually are not suitable, follow the procedure below to discard the manual settings and reload the previous YPAO adjustments.

- 1 In the “Setup” menu, select “Speaker”, “Auto Setup”, and then “Result” (p.136).
- 2 Use the cursor keys to select “Setup Reload” and press ENTER.

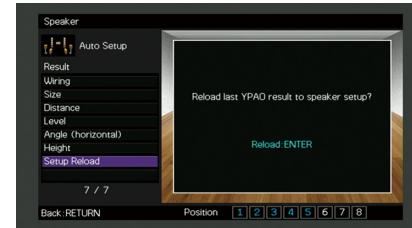

- 3 To exit from the menu, press ON SCREEN.

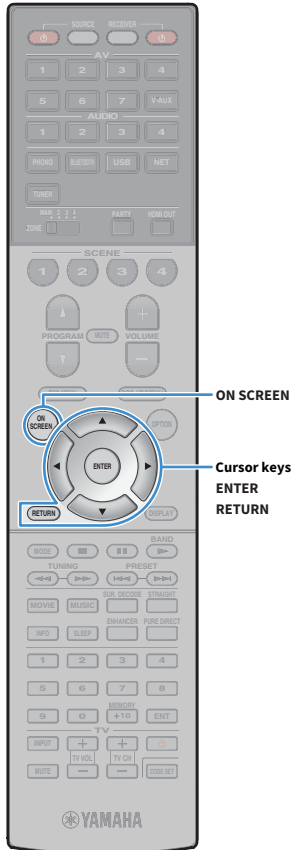

## Error messages

If any error message is displayed during the measurement, resolve the problem and perform YPAO again.

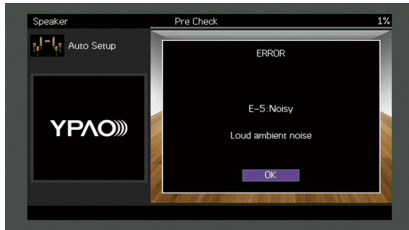

Error message	Cause	Remedy
<b>E-1: No Front SP</b>	Front speakers are not detected.	
<b>E-2: No Sur. SP</b>	One of the surround speakers cannot be detected.	Follow the on-screen instructions to exit YPAO, turn off the unit, and then check the speaker connections.
<b>E-3: No F.PRNS SP</b>	One of the front presence speakers cannot be detected.	
<b>E-4: SBR → SBL</b>	A surround back speaker is connected to the R side only.	
<b>E-5: Noisy</b>	The noise is too loud.	When using only one surround back speaker, you need to connect it to the SINGLE jack (L side). Follow the on-screen instructions to exit YPAO, turn off the unit, and then reconnect the speaker. Keep the room quiet and follow the on-screen instructions to start the measurement again. If you select "PROCEED", YPAO takes the measurement again and ignores any noise detected.
<b>E-6: Check Sur.</b>	Surround back speakers are connected, but no surround speakers are connected.	Surround speakers need to be connected in order to use surround back speakers. Follow the on-screen instructions to exit YPAO, turn off the unit, and then reconnect the speakers.
<b>E-7: No MIC</b>	The YPAO microphone has been removed.	Connect the YPAO microphone to the YPAO MIC jack firmly and follow the on-screen instructions to start the measurement again.
<b>E-8: No Signal</b>	The YPAO microphone cannot detect test tones.	Connect the YPAO microphone to the YPAO MIC jack firmly and follow the on-screen instructions to start the measurement again. If this error occurs repeatedly, contact the nearest authorized Yamaha dealer or service center.
<b>E-9: User Cancel</b>	The measurement has been canceled.	Follow the on-screen instructions to start the measurement again. To cancel the measurement, select "EXIT".
<b>E-10: Internal Error</b>	An internal error has occurred.	Follow the on-screen instructions to exit YPAO, turn off and on the unit. If this error occurs repeatedly, contact the nearest authorized Yamaha dealer or service center.
<b>E-11: No R.PRNS SP</b>	One of the rear presence speakers cannot be detected.	Follow the on-screen instructions to exit YPAO, turn off the unit, and then check the speaker connections.



## Warning messages

If a warning message is displayed after the measurement, you can still save the measurement results by following on-screen instructions.

However, we recommend you perform YPAO again in order to use the unit with the optimal speaker settings.



Warning message	Cause	Remedy
<b>W-1: Out of Phase</b>	A speaker cable may be connected with the reverse polarity (+/-).	<p>Select "Wiring" in "Result" (p.63) and check the cable connections (+/-) of the speaker identified by "Reverse".</p> <p><b>If the speaker is connected incorrectly:</b> Turn off the unit and then reconnect the speaker cable.</p> <p><b>If the speaker is connected correctly:</b> Depending on the type of speakers or room environment, this message may appear even if the speakers are connected correctly. In this case, you can ignore the message.</p>
<b>W-2: Over Distance</b>	A speaker is placed more than 24 m (80 ft) from the listening position.	Select "Distance" in "Result" (p.63) and move the speaker identified by ">24.00m (>80.0ft)" within 24 m (80 ft) of the listening position.
<b>W-3: Level Error</b>	There are significant volume differences between the speakers.	Select "Level" in "Result" (p.63) and check the speaker identified by "Over ±10.0dB", then check the usage environment and cable connections (+/-) of each speaker, and the volume of the subwoofer. We recommend using the same speakers or speakers with specifications that are as similar as possible.

## 10 Connecting to a network device wirelessly

Connect the unit to a wireless router (access point) or a mobile device by establishing a wireless connection.

### Selecting the connection method

Select a connection method according to your network environment.

#### ■ Connecting with a wireless router (access point)

Connect the unit to a wireless router (access point).

You can enjoy Internet radio, AirPlay, or music files stored on media servers (PC/NAS) on the unit.

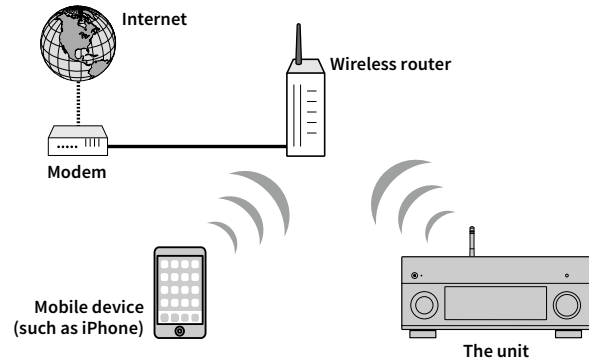

For details on connection, see “Connecting the unit to a wireless network” (p.67).



You cannot use the wireless network connection simultaneously with Wireless Direct (p.72).

#### ■ Connecting without a wireless router (access point)

Connect a mobile device to the unit directly.

You can use the application for smartphone / tablet “AV CONTROLLER” (p.12) to control the unit from mobiles devices or enjoy music files stored on mobiles devices on the unit.

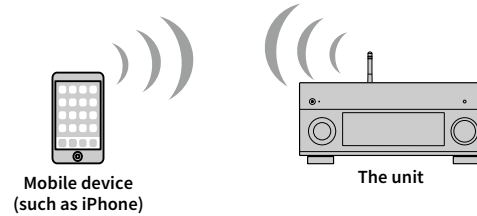

For details on connection, see “Connecting a mobile device to the unit directly (Wireless Direct)” (p.72).



- You cannot use Wireless Direct simultaneously with the wired (network cable) connection (p.50) or the wireless network connection (p.67).
- When Wireless Direct is enabled, the both the unit and mobile device cannot be connected to the Internet. In this case, you cannot use the Internet services such as Internet radio. To use the Internet services, terminate the Wireless Direct connection on the mobile device.

## Connecting the unit to a wireless network

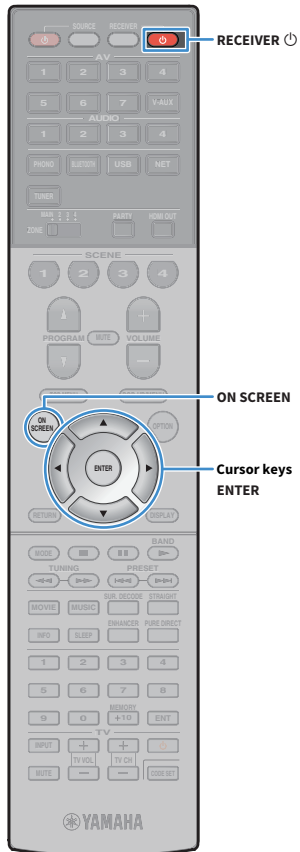

There are several methods to connect the unit to a wireless network. Select a connection method according to your environment.

- Using MusicCast CONTROLLER (p.74)
- Sharing the iOS device setting (p.67)
- Using the WPS push button configuration (p.68)
- Using other connection methods (p.69)

### Sharing the iOS device setting

You can easily set up a wireless connection by applying the connection settings on iOS devices (iPhone/iPad/iPod touch).

Before proceeding, confirm that your iOS device is connected to a wireless router.



If you set up a wireless connection with this method, the following settings will be initialized.

- Network settings
- Bluetooth settings
- USB and network items registered as shortcuts
- Internet radio stations register to “Favorites”
- Account information for the network services



- You need iOS device with iOS 7 or later. (The following procedure is a setup example for iOS 8.)
- This configuration does not work if the security method of your wireless router (access point) is WEP. In this case, use other connection method.

- 1 Press RECEIVER to turn on the unit.
- 2 Turn on the TV and switch the TV input to display video from the unit (HDMI OUT jack).



Operations with TV screen are available only when your TV is connected to the unit via HDMI.

- 3 Press ON SCREEN.

- 4 Use the cursor keys to select “Setup” and press ENTER.
- 5 Use the cursor keys (◀/▶) to select “Network”.
- 6 Use the cursor keys (▲/▼) to select “Network Connection” and press ENTER.
- 7 Use the cursor keys (▲/▼) and ENTER to check “Wireless (Wi-Fi)” and select “OK”.

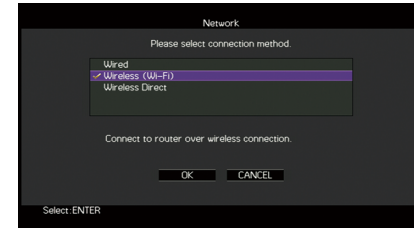

The checkmark indicates the current setting.

- 8 Use the cursor keys (▲/▼) and ENTER to check “Share Wi-Fi Settings (iOS)” and select “NEXT”.

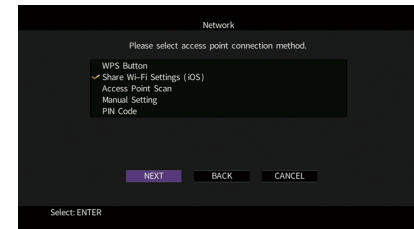

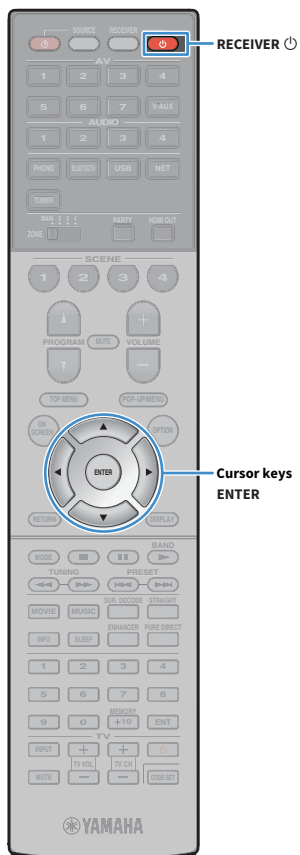

**9** After checking the on-screen message, use the cursor keys (◀/▶) and ENTER to select “NEXT”.

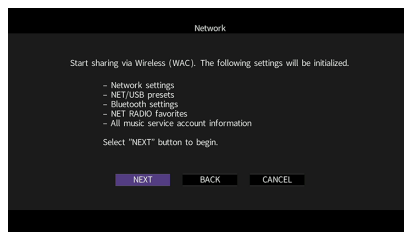

**10** On the iOS device, select the unit as the AirPlay speaker in the Wi-Fi screen.



The name of the unit

**11** Check the network currently selected and tap “Next”.

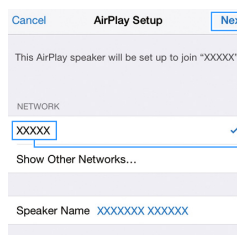

Tap here to start setup

The network currently selected

When the sharing process finishes, the unit is automatically connected to the selected network (access point).

## Using the WPS push button configuration

You can easily set up a wireless connection with one push of the WPS button.



This configuration does not work if the security method of your wireless router (access point) is WEP. In this case, use other connection method.

- 1** Press RECEIVER to turn on the unit.
- 2** Hold down INFO (WPS) on the front panel for 3 seconds.  
“Press WPS button on Access Point” appears on the front display.
- 3** Push the WPS button on the wireless router (access point).

When the connection process finishes, “Completed” appears on the front display.

If “Not connected” appears, repeat from Step 1 or try another connection method.

### About WPS

WPS (Wi-Fi Protected Setup) is a standard established by the Wi-Fi Alliance, which allows easy establishment of a wireless home network.

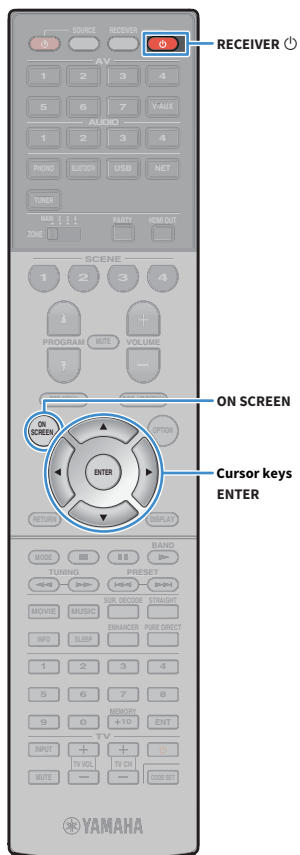

## ■ Using other connection methods

If your wireless router (access point) does not support WPS push button configuration method, follow the procedure below to configure the wireless network settings.

- 1 Press RECEIVER to turn on the unit.
  - 2 Turn on the TV and switch the TV input to display video from the unit (HDMI OUT jack).
- !** Operations with TV screen are available only when your TV is connected to the unit via HDMI.
- 3 Press ON SCREEN.
  - 4 Use the cursor keys to select “Setup” and press ENTER.
  - 5 Use the cursor keys (◀/▶) to select “Network”.
  - 6 Use the cursor keys (▲/▼) to select “Network Connection” and press ENTER.
  - 7 Use the cursor keys (▲/▼) and ENTER to check “Wireless (Wi-Fi)” and select “OK”.

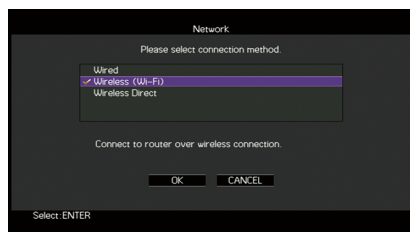

The checkmark indicates the current setting.

- 8 Use the cursor keys (▲/▼) and ENTER to select the desired connection method and select “NEXT”.

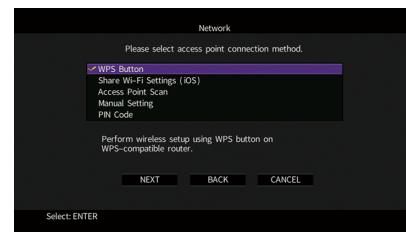

The following connection methods are available.

<b>WPS Button</b>	You can set up a wireless connection with the WPS button while viewing the TV screen. Follow the instructions displayed on the TV screen.
<b>Share Wi-Fi Settings (iOS)</b>	See “Sharing the iOS device setting” (p.67).
<b>Access Point Scan</b>	You can set up a wireless connection by searching for an access point. For details on settings, see “Searching for an access point” (p.70).
<b>Manual Setting</b>	You can set up a wireless connection by entering the required information (such as SSID) manually. For details on settings, see “Setting up the wireless connection manually” (p.70).
<b>PIN Code</b>	You can set up a wireless connection by entering the unit’s PIN code into the wireless router (access point). The method is available if the wireless router (access point) supports the WPS PIN code method. For details on settings, see “Using the PIN code” (p.71).

## Searching for an access point

If you select “Access Point Scan” as the connection method, the unit starts searching for access points. After a while, the list of available access points appears on the TV screen.

- 1 Use the cursor keys and ENTER to check the desired access point and select “NEXT”.

The wireless connection setting screen appears on the TV.

- 2 Use the cursor keys and ENTER to enter the security key and select “NEXT”.



- 3 Use the cursor keys (◀/▶) to select “CONNECT” and press ENTER to start the connection process.

When the connection process finishes, “Completed” appears on the TV screen.

If “Not connected” appears, repeat from Step 1 or try another connection method.

- 4 To exit from the menu, press ON SCREEN.

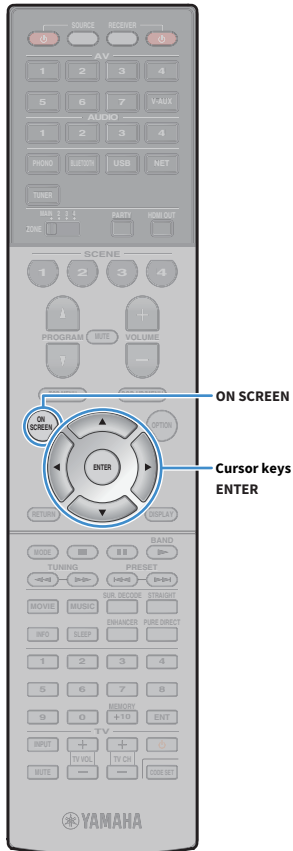

## Setting up the wireless connection manually

If you select “Manual Setting” as the connection method, the wireless connection setting screen appears on the TV.

You need to setup the SSID (network name), encryption method and security key for your network.

- 1 Use the cursor keys and ENTER to enter the SSID of the access point and select “NEXT”.



- 2 Use the cursor keys (▲/▼) and ENTER to check the security method of the access point and select “NEXT”.

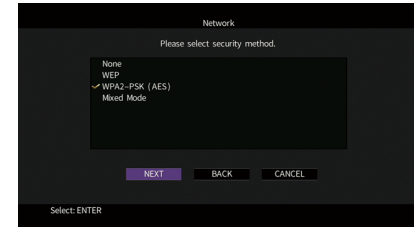

### Settings

None, WEP, WPA2-PSK (AES), Mixed Mode

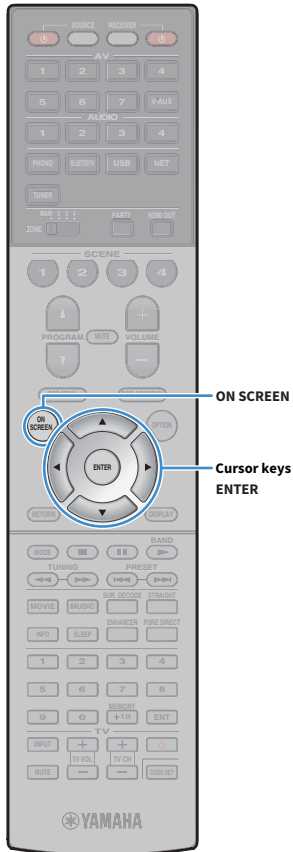

### 3 Use the cursor keys and ENTER to enter the security key and select “NEXT”.

If you select “None” in Step 2, this setting is not available. Proceed to Step 4.

If you select “WEP”, enter either 5 or 13 character string, or 10 or 26 hexadecimal digits.

If you select other method, enter either 8 to 63 character string, or 64 hexadecimal digits.



### 4 Use the cursor keys (◀/▶) to select “CONNECT” and press ENTER to start the connection process.

When the connection process finishes, “Completed” appears on the TV screen.

If “Not connected” appears, check that all the information is entered correctly, and repeat from Step 1.

### 5 To exit from the menu, press ON SCREEN.

## Using the PIN code

If you select “PIN Code” as the connection method, the list of available access points appears on the TV screen.

### 1 Use the cursor keys and ENTER to check the desired access point and select “NEXT”.

The PIN code of the unit appears on the TV screen.

### 2 Enter the unit’s PIN code into the wireless router (access point).

For details on settings, refer to the instruction manual of the wireless router (access point).

### 3 Use the cursor keys (◀/▶) to select “CONNECT” and press ENTER to start the connection process.

When the connection process finishes, “Completed” appears on the TV screen.

If “Not connected” appears, repeat from Step 1 or try another connection method.

### 4 To exit from the menu, press ON SCREEN.

## Connecting a mobile device to the unit directly (Wireless Direct)

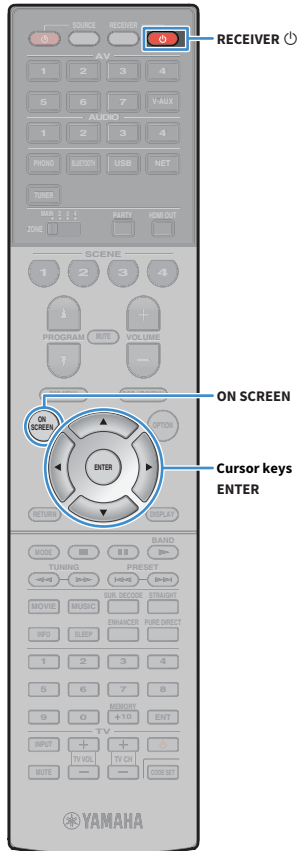

Follow the procedure below to connect a mobile device to the unit directly.

**!** Wireless Direct connection may be insecure since the communication is not strongly encrypted. The unit may operate by playback operation on wireless devices connected to the unit without permission.

- 1 Press RECEIVER to turn on the unit.
- 2 Turn on the TV and switch the TV input to display video from the unit (HDMI OUT jack).  
**!** Operations with TV screen are available only when your TV is connected to the unit via HDMI.
- 3 Press ON SCREEN.
- 4 Use the cursor keys to select “Setup” and press ENTER.
- 5 Use the cursor keys (◀/▶) to select “Network”.
- 6 Use the cursor keys (▲/▼) to select “Network Connection” and press ENTER.

- 7 Use the cursor keys (▲/▼) and ENTER to check “Wireless Direct” and select “OK”.

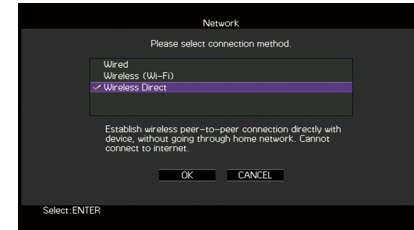

The checkmark indicates the current setting.

- 8 Use the cursor keys (▲/▼) and ENTER to check the desired security method and select “NEXT”.

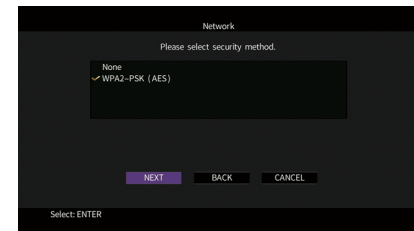

### Settings

None, WPA2-PSK (AES)



If you select “None”, the connection may be insecure since the communication is not encrypted.



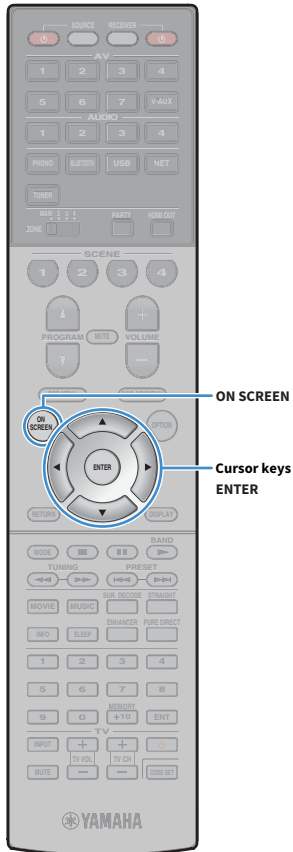

## 9 Use the cursor keys and ENTER to enter the security key and select “NEXT”.

If you select “None” in Step 8, this setting is not available. Proceed to Step 10.

Otherwise, either 8 to 63 character string, or 64 hexadecimal digits.



## 10 Use the cursor keys (◀/▶) to select “OK” and press ENTER to save the setting.

The settings made appear on the TV screen.

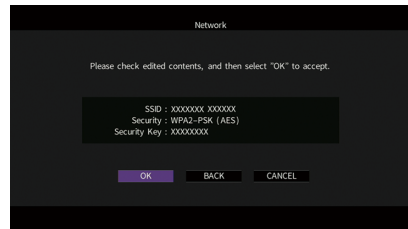

The SSID and security key information is required for setup of a mobile device.

## 11 Configure the Wi-Fi settings of a mobile device.

For details on settings of your mobile device, refer to the instruction manual of the mobile device.

- 1 Enable the Wi-Fi function on the mobile device.
- 2 Select the SSID displayed in Step 10 from the list of available access points.
- 3 When you are prompted for a password, enter the security key displayed in Step 10.

## 12 To exit from the menu, press ON SCREEN.

## 11 Connecting to the MusicCast network

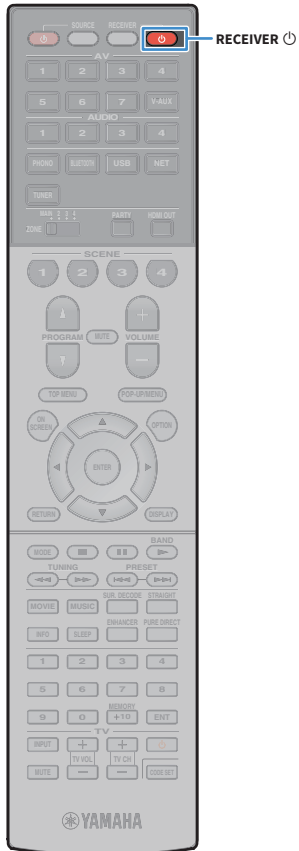

MusicCast is a brand new wireless musical solution from Yamaha, allowing you to share music among all of your rooms with a variety of devices. You can enjoy music from your smartphone, PC, NAS drive and music streaming service anywhere in your house with one easy-to-use application. For more details and a lineup of MusicCast compatible products, visit the Yamaha website.

- Seamlessly control all MusicCast compatible devices with the dedicated application “MusicCast CONTROLLER”.
- Link a MusicCast compatible device to another device in a different room and play them back simultaneously.
- Play back music from music streaming services. (The compatible music streaming services may differ depending on your region and product.)

### MusicCast CONTROLLER



To use the network features on the MusicCast compatible device, you need the dedicated application “MusicCast CONTROLLER” for the operation. Search for the free application “MusicCast CONTROLLER” on the App Store or Google Play and install it to your device.

### Adding the unit to the MusicCast network

Follow the procedure below to add the unit to the MusicCast network. You can also configure the unit’s wireless settings at once.



- The SSID and security key for your network will be needed.
- If your router supports multiple SSID’s (network names), connect the mobile device to the first access point (“SSID 1”, etc.).

- 1 Press RECEIVER  to turn on the unit.
- 2 Tap the “MusicCast CONTROLLER” application icon on your mobile device and tap “Setup”.



If you have already connected other MusicCast compatible devices to the network, tap “Settings” and then “Add New Device”.

- 3 Operate the “MusicCast CONTROLLER” application following the on screen instructions, then hold down CONNECT on the front panel of the unit for 5 seconds.

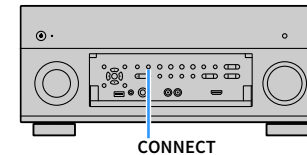

- 4 Operate the “MusicCast CONTROLLER” application following the onscreen instructions to set up the network.
- 5 Operate the “MusicCast CONTROLLER” application to playback.



- AirPlay and DSD audio cannot be delivered.
- When Pure Direct is enabled, input sources other than the network sources and USB cannot be delivered.
- If you configure the unit’s wireless settings with this method, the signal strength indicator of the front display lights up when the unit is connecting to a network (even if a wired connection is used).
- You can interlock the power of MusicCast devices with the power of the unit (MusicCast master). For details, see “MusicCast Link Power Interlock” (p.152) in the “Setup” menu.

# PLAYBACK

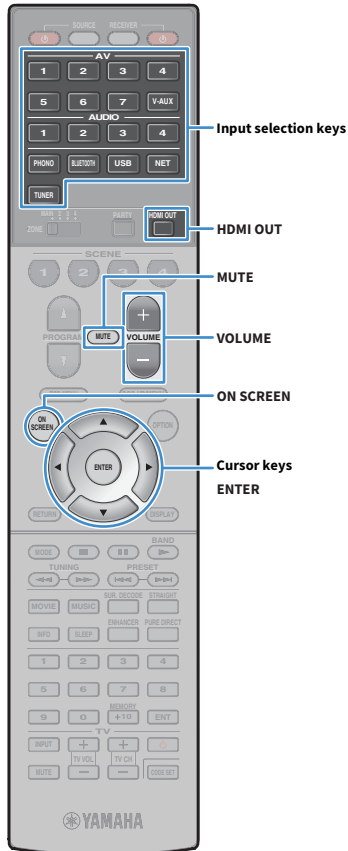

## Basic playback procedure

- 1 Turn on the external devices (such as a TV or BD/DVD player) connected to the unit.
- 2 Use the input selection keys to select an input source.
- 3 Start playback on the external device or select a radio station.

Refer to the instruction manual for the external device.

For details on the following operations, see the corresponding pages.

- Listening to FM/AM radio (China model only) (p.84)
- Listening to DAB radio (Australia model only) (p.87)
- Listening to FM radio (Australia model only) (p.92)
- Playing back music via Bluetooth (p.95)
- Playing back music stored on a USB storage device (p.97)
- Playing back music stored on media servers (PCs/NAS) (p.101)
- Listening to Internet radio (p.105)
- Playing back iTunes/iPod music with AirPlay (p.108)

- 4 Press VOLUME to adjust the volume.



- To mute the audio output, press MUTE. Press MUTE again to unmute.
- To adjust the treble/bass settings, use the “Option” menu or TONE CONTROL on the front panel (p.123).

### On-screen input selection

- 1 Press ON SCREEN.
- 2 Use the cursor keys to select “Input” and press ENTER.
- 3 Use the cursor keys to select the desired input source and press ENTER.

### Selecting an HDMI output jack

- 1 Press HDMI OUT to select an HDMI OUT jack.

Each time you press the key, the HDMI OUT jack to be used for signal output changes.



<b>OUT 1+2</b>	Outputs the same signal at both the HDMI OUT 1 and HDMI OUT 2 jacks.
<b>OUT 1</b>	Output the signals at the selected HDMI OUT jack.
<b>OUT 2</b>	Output the signals at the selected HDMI OUT jack.
<b>Off</b>	Does not output the signals at the HDMI OUT jacks.



- You can also select an HDMI output jack by selecting a scene (p.76).
- When “OUT 1+2” is selected, the unit outputs video signals at the highest resolution supported by both TVs (or projectors) connected to the unit. (For example, if you have connected a 1080p TV to the HDMI OUT 1 jack and a 720p TV to the HDMI OUT 2 jack, the unit outputs 720p video signals.)
- If the HDMI OUT 2 jack is assigned to Zone2 or Zone4 (p.155), you can turn on/off each zone by pressing HDMI OUT repeatedly.

## Selecting the input source and favorite settings with one touch (SCENE)

The SCENE function allows you to select the assigned input source, sound program, HDMI output and various settings with just one touch. You can use up to 12 scenes to register your favorite settings and switch them depending on a playback source.

### 1 Press SCENE.

The input source and settings registered to the corresponding scene are selected. The unit turns on automatically when it is in standby mode.

By default, the following settings are registered for each scene.

SCENE (SCENE key)		1	2	3	4
<b>Input</b>	<b>Input (p.75)</b>	AV 1	AUDIO 1	NET RADIO	TUNER
	<b>Audio Select (p.126)</b>	Auto	Auto	—	—
<b>HDMI Output</b>	<b>HDMI Output (p.75)</b>	OUT 1+2	OUT 1+2	OUT 1+2	OUT 1+2
	<b>DSP Program (p.78)</b>	Sci-Fi	STRAIGHT	9ch Stereo	9ch Stereo
<b>Mode</b>	<b>Pure Direct Mode (p.146)</b>	Auto	Auto	Auto	Auto
	<b>Enhancer (p.83)</b>	Off	On	On	On
	<b>Enhancer Hi-Res Mode (p.125)</b>	On	On	On	On



You can select SCENE 1-4 by pressing SCENE on the remote control. Additionally, you can create 8 scenes (SCENE 5-12) and select those scenes from the “Scene” menu (p.130).

### On-screen scene selection

- ① Press ON SCREEN.
- ② Use the cursor keys to select “Scene” and press ENTER.
- ③ Use the cursor keys to select a desired scene and press ENTER.

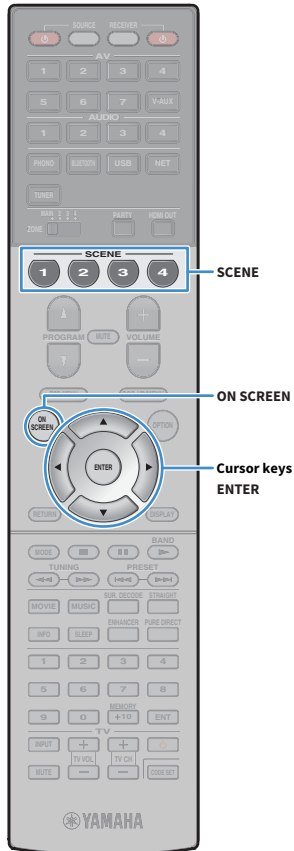

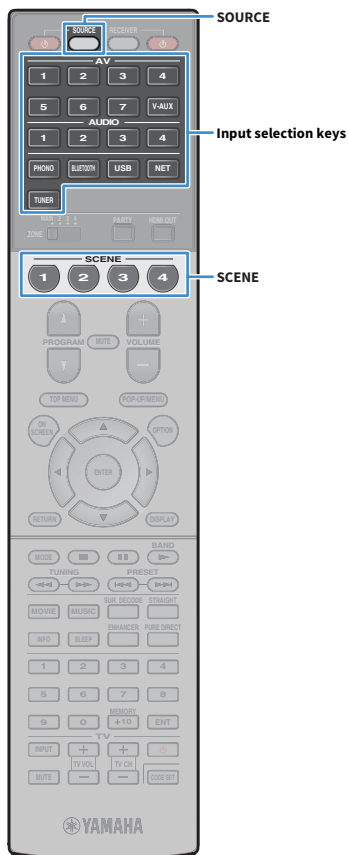

## Registering a scene

- 1 Set the unit to the condition (such as input source and sound program) that you want to assign to a scene.
  - 2 Hold down the desired SCENE key until “SET Complete” appears on the front display.
- 
- 3 If you want to control the corresponding playback device after selecting the scene, hold down the corresponding SCENE key and input selection key together for more than 3 seconds.

Once the setting is completed successfully, SOURCE blinks twice.



- If you have not registered the remote control code of the playback device yet, see “Registering the remote control codes for playback devices” (p.167) to register it.
- The SCENE link playback function allows you to start playback of an external device connected to the unit via HDMI. To enable SCENE link playback, specify the device type in “Device Control” (p.131) in the “Scene” menu.

## Selecting setting items to be included as scene assignments

In addition to the default scene assignments (Input, HDMI Output and Mode), you can also include the following setting items as the scene assignments in “Detail” (p.131) in the “Scene” menu.

<b>Sound</b>	Tone Control, YPAO Volume, Adaptive DRC, Extra Bass
<b>Surround</b>	CINEMA DSP 3D Mode, Dialogue Lift, Dialogue Level, Subwoofer Trim
<b>Video</b>	Video Mode, Video Adjustment
<b>Volume</b>	Master Volume
<b>Lipsync</b>	Lipsync, Delay
<b>Speaker Setup</b>	Setting Pattern, PEQ Select



When the input source is TUNER, USB or NET, the selected radio station or content is assigned.

## Selecting the sound mode

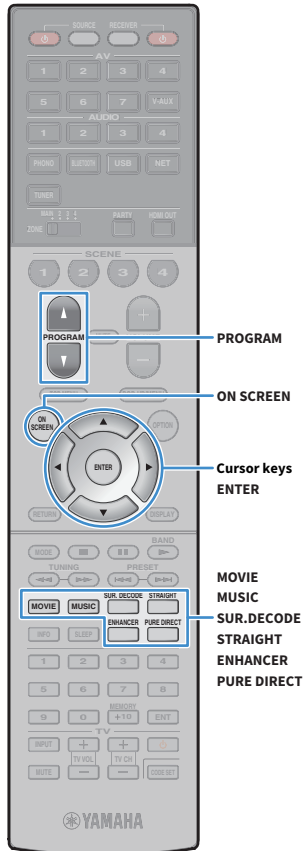

The unit is equipped with a variety of sound programs and surround decoders that allow you to enjoy playback sources with your favorite sound mode (such as sound field effect or stereo playback).

### Selecting a sound program suitable for movies

- Press MOVIE repeatedly.

This mode lets you enjoy sound field effects optimized for viewing video sources, such as movies, TV programs, and games (p.79).

### Selecting a sound program suitable for music or stereo playback

- Press MUSIC repeatedly.

This mode lets you enjoy sound field effects optimized for listening music sources or stereo playback (p.80).

### Selecting a surround decoder

- Press SUR. DECODE repeatedly.

This mode lets you enjoy unprocessed multichannel playback from 2-channel sources (p.82).

### Switching to the straight decode mode

- Press STRAIGHT.

This mode lets you enjoy unprocessed sounds in original channels (p.82).

### Switching to the Pure Direct mode

- Press PURE DIRECT.

This mode lets you enjoy pure high fidelity sound by reducing the electrical noise from other circuitry (p.83).

### Enabling Compressed Music Enhancer

- Press ENHANCER.

This mode lets you enjoy compressed music with additional depth and breadth (p.83).

### On-screen sound program/surround decoder selection

- ① Press ON SCREEN.
- ② Use the cursor keys to select “DSP Program” and press ENTER.
- ③ Use the cursor keys to select a sound program/surround decoder and press ENTER.



- You can also switch the sound programs and surround decoder by pressing PROGRAM.
- You can change the settings of the surround programs and surround decoders in the “DSP Program” menu (p.133).
- The sound mode can be applied separately to each input source.
- You can check which speakers are currently outputting sound by looking at the speaker indicators on the unit’s front panel (p.15) or at the “Audio Signal” screen in the “Information” menu (p.159).

#### Precaution for enjoying Dolby Atmos®

- Dolby Atmos contents are decoded as Dolby TrueHD or Dolby Digital Plus in the following situations. (Dolby Atmos PCM format is always decoded as Dolby Atmos.)
  - Neither surround back nor presence speakers are used.
  - Headphones are used (2-channel playback).
- When the Dolby Atmos decoder is working, virtual surround processing (such as Virtual CINEMA FRONT) (p.81) does not work.

#### Precaution for enjoying DTS:X™

- When DTS:X contents are played back, you can adjust the volume of dialogue sounds in “DTS Dialogue Control” (p.124) in the “Option” menu.
- When the DTS:X decoder is working, virtual surround processing (such as Virtual CINEMA FRONT) (p.81) does not work.

## Enjoying stereoscopic sound fields (CINEMA DSP HD<sup>3</sup>)



The unit is equipped with a variety of sound programs that utilize Yamaha's original DSP technology (CINEMA DSP HD<sup>3</sup>). It allows you to easily create sound fields like actual movie theaters or concert halls in your room and enjoy natural stereoscopic sound fields.

### Sound program category



Sound program

“CINEMA DSP HD<sup>3</sup>” lights up



- To use the conventional CINEMA DSP, set “CINEMA DSP 3D Mode” (p.146) in the “Setup” menu to “Off”.
- The unit creates front Virtual Presence Speaker (VPS) using the front, center, and surround speakers to produce 3-dimensional sound fields even when no front presence speakers are connected. However, we recommend using front presence speakers in order to experience the full effect of the sound fields (and rear presence speakers for further spatial sounds).
- The unit creates rear Virtual Presence Speaker (VPS) using the front, center, and surround speakers to produce natural 3-dimensional sound fields when front presence speakers are connected but no rear presence speakers.
- If a multichannel source (6.1 channels or more) is input when no surround back speakers are connected, the unit creates Virtual Surround Back Speaker (VSBS) using the surround speakers to add a sense of depth to the rear sound field.
- When VPS or VSBS is working, “VIRTUAL” lights up in the front display.

## Sound programs suitable for movies (MOVIE)

The following sound programs are optimized for viewing video sources, such as movies, TV programs, and games.

### MOVIE THEATER

<b>Standard</b>	This program creates a sound field that emphasizes the surround feeling without disturbing the original acoustic positioning of multichannel audio. Its design is based on the concept of the ideal movie theater, in which the audience is surrounded by beautiful reverberations from the left, right, and rear.
<b>Spectacle</b>	This program delivers the scale and grandeur of spectacular movie productions. It delivers an expansive sound space to match the cinemascope wide-screen, and boasts a broad dynamic range, providing everything from small delicate sounds to powerful loud booms.
<b>Sci-Fi</b>	This program clearly reproduces the finely elaborated sound design of the latest Sci-Fi and SFX movies. You can enjoy a variety of cinematographically created virtual spaces reproduced with clear separation between dialogue, sound effects, and background music.
<b>Adventure</b>	This program is ideal for reproducing the sound design of action and adventure movies precisely. The sound field restrains reverberations, but puts emphasis on reproducing a sensation of expansiveness on both sides, powerful space expanded widely to the left and right. The restrained depth creates a clear and powerful space, while also maintaining the articulation of the sounds and the separation of the channels.
<b>Drama</b>	This program features stable reverberations that match a wide range of movie genres, from serious dramas to musicals and comedies. The reverberations are modest, but suitably stereophonic. The sound effects and background music are reproduced with a gentle echo that does not impinge on the articulation of the dialogue. You'll never get tired listening for long periods.
<b>Mono Movie</b>	This program reproduces monaural video sources, such as classic movies, in an atmosphere of a good old movie theater. The program creates a pleasant space with depth, by adding breadth and the appropriate reverberation to the original audio.
<b>Enhanced</b>	This program creates a sound field that emphasizes the dynamic sound transition of 3D object audio. Its design is based on the concept of a movie theater with multi-top speakers, in which the audience is overwhelmed by the natural and powerful sound effects.

## ENTERTAINMENT

<b>Sports</b>	This program allows listeners to enjoy the rich vividness of sport broadcasts and light entertainment programs. In sports broadcasts, the commentators' voices are positioned clearly at the center, while the atmosphere inside the stadium is realistically conveyed by the peripheral delivery of the sounds of the fans in a suitable space.
<b>Action Game</b>	This program is suitable for action games, such as car racing and fighting games. The reality of, and emphasis on, various effects makes the player feel like they are right in the middle of the action, allowing for greater concentration. Use this program in combination with Compressed Music Enhancer for a more dynamic and strong sound field.
<b>Roleplaying Game</b>	This program is suitable for role-playing and adventure games. This program adds depth to the sound field for natural and realistic reproduction of background music, special effects, and dialogue from a wide variety of scenes. Use this program in combination with Compressed Music Enhancer for a clearer and more spatial sound field.
<b>Music Video</b>	This program allows you to enjoy videos of pop, rock, and jazz concerts, as if you were there yourself. Immerse yourself in the hot concert atmosphere thanks to the vividness of the singers and solos on stage, a presence sound field that emphasizes the beat of rhythm instruments, and a surround sound field that reproduces the space of a big live hall.
<b>Recital/Opera</b>	This program controls the amount of reverberations at an optimum level and emphasizes the depth and clarity of human voices to offer the reverberations of an orchestra box in front the listener at the same time as providing the acoustic positioning and feeling of presence on the stage. The surround sound field is relatively moderate, but the data for concert hall effects are used to represent the inherent beauty of music. The listener will not be fatigued even after long hours of opera entertainment.

## Sound programs suitable for music/stereo playback (MUSIC)

The following sound programs are optimized for listening to music sources.

You can also select stereo playback.

## CLASSICAL

<b>Hall in Munich</b>	This program simulates a Munich concert hall with approximately 2,500 seats that uses stylish wood for the interior finishing. Fine, beautiful reverberations spread richly, creating a calming atmosphere. The listener's virtual seat is at the center left of the arena.
<b>Hall in Vienna</b>	This program simulates a 1,700-seat, middle-sized concert hall with a shoebox shape that is traditional in Vienna. Pillars and ornate carvings create extremely complex reverberations from all around the audience, producing a very full, rich sound.
<b>Hall in Amsterdam</b>	The large, shoe box shaped hall seats about 2,200 around the circle stage. Reflections are rich and pleasing while the sound travels freely.
<b>Church in Freiburg</b>	Located in the south of Germany, this grand, stone-built church has a pointed tower at 120 meters in height. Its long and narrow shape and the high ceiling enable the elongated reverberation time and limited initial reflection time. Thus, the rich reverberation rather than the sound itself reproduces the atmosphere of the church.
<b>Church in Royaumont</b>	This program features the sound field created by the refectory (dining hall) of a beautiful medieval Gothic monastery located in Royaumont on the outskirts of Paris.
<b>Chamber</b>	This program creates a relatively wide space with a high ceiling, like an audience hall in a palace. It offers pleasant reverberations that are suitable for courtly music and chamber music.



## LIVE/CLUB

<b>Village Vanguard</b>	The Jazz club is on 7th Avenue, New York. This small club with the low ceiling makes the powerful reflections converge toward the stage located in the center.
<b>Warehouse Loft</b>	The warehouse resembles some lofts in Soho. Sound reflects off the concrete walls clearly with a lot of energy.
<b>Cellar Club</b>	This program simulates an intimate concert venue with a low ceiling and homey atmosphere. A realistic, live sound field delivers powerful sounds that make you feel as if you are sitting in the front row in front of a small stage.
<b>The Roxy Theatre</b>	This program creates the sound field of a 460-seat rock music concert venue in Los Angeles. The listener's virtual seat is at the center left of the hall.
<b>The Bottom Line</b>	This program creates the sound field at stage front in The Bottom Line, a famous New York jazz club once. The floor can seat 300 people to the left and right in a sound field offering real and vibrant sound.

## STEREO

<b>2ch Stereo</b>	Use this program to mix down multichannel sources to 2 channels. When multichannel signals are input, they are down mixed to 2 channels and output from the front speakers (this program does not utilize CINEMA DSP).
<b>9ch Stereo</b>	Use this program to output sound from all speakers. When you play back multichannel sources, the unit mixes down the source to 2 channels, and then outputs the sound from all speakers. This program creates a larger sound field and is ideal for background music at parties.



CINEMA DSP HD<sup>3</sup> (p.79) and Virtual CINEMA DSP (p.81) do not work when “2ch Stereo” or “9ch Stereo” is selected.

## Enjoying sound field effects without surround speakers (Virtual CINEMA DSP)

If you select one of the sound programs (except 2ch Stereo and 9ch Stereo) when no surround speakers are connected, the unit utilizes Yamaha's original virtual surround technology to reproduce up to 7-channel surround sound and enable you to enjoy the well-oriented sound field only with the front-side speakers. We recommend using presence speakers in order to enjoy more effective stereoscopic sound field.



When Virtual CINEMA DSP is working, “VIRTUAL” lights up in the front display.

## Enjoying surround sound with 5 speakers placed in front (Virtual CINEMA FRONT)

If you have surround speakers but there is no space to place them in the rear of your room, you can place them in the front (p.24) and enjoy multichannel surround sound using Virtual CINEMA FRONT.

When “Layout (Surround)” (p.143) in the “Setup” menu is set to “Front”, the unit creates the virtual surround speakers in the rear side to allow you to enjoy multichannel surround sound with the 5 speakers placed in the front.



When Virtual CINEMA FRONT is working, “VIRTUAL” lights up in the front display.

## Enjoying surround sound with headphones (SILENT CINEMA)

SILENT™  
CINEMA

You can enjoy surround or sound field effects, like a multichannel speaker system, with stereo headphones by connecting the headphones to the PHONES jack and selecting a sound program or a surround decoder.

## Enjoying unprocessed playback

You can play back input sources without any sound field effect processing.

### ■ Playing back in original channels (straight decode)

When the straight decode mode is enabled, the unit produces stereo sound from the front speakers for 2-channel sources such as CDs, and produces unprocessed multichannel sounds for multichannel sources.

#### 1 Press STRAIGHT.

Each time you press the key, the straight decode mode is enabled or disabled.



- To enable 6.1/7.1-channel playback from 5.1-channel sources when surround back speakers are used, select a surround decoder (p.82).
- If “Layout (Surround)” (p.143) in the “Setup” menu is set to “Front”, Virtual CINEMA FRONT (p.81) works when multichannel source is played back.

### ■ Playing back in extended multichannel (surround decoder)

The surround decoder enables unprocessed multichannel playback from 2-channel or multichannel sources.



- Speakers that produce sounds will change depending on your speaker system and the selected decode type (p.134).
- For details on each decoder, see “Glossary” (p.182).

#### 1 Press SUR. DECODE to select a surround decoder.

Each time you press the key, the surround decoder changes.



<b>Auto</b>	Uses the decoder automatically selected by input source. The DTS Neural:X decoder is selected for DTS sources and the Dolby Surround decoder is selected for other sources.
<b>Dolby Dsur</b>	Uses the Dolby Surround decoder suitable for your speaker layout. A real acoustic space (including overhead) will be created especially when object-based audio (such as Dolby Atmos content) is played.
<b>Neural:X</b>	Uses the DTS Neural:X decoder suitable for your speaker layout. A real acoustic space (including overhead) will be created especially when object-based audio (such as DTS:X content) is played.
<b>Neo:6 Cinema</b>	Uses the DTS Neo:6 decoder (or DTS-ES Matrix decoder) suitable for movies. Sounds will be output from the surround/surround back speakers.
<b>Neo:6 Music</b>	Uses the DTS Neo:6 decoder (or DTS-ES Matrix decoder) suitable for music. Sounds will be output from the surround/surround back speakers.



- If the Dolby Surround decoder is selected when only one surround back speaker is used, no sound is output from the surround back speaker (except when a Dolby Atmos content or a DTS:X content is played).
- When the Dolby Surround or Neural:X decoder is selected, virtual surround processing (such as Virtual CINEMA FRONT) (p.81) does not work.

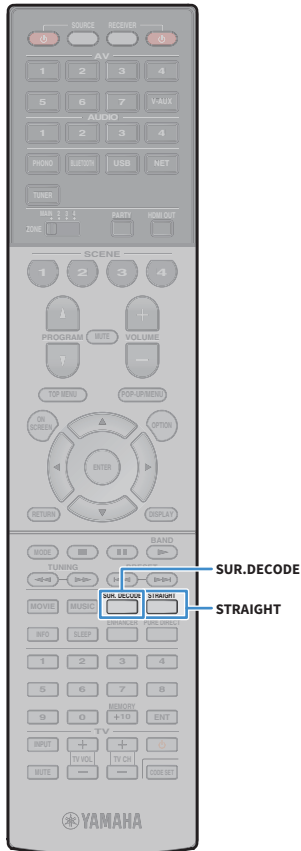

## Enjoying pure high fidelity sound (Pure Direct)

When Pure Direct is enabled, the unit plays back the selected source with the least circuitry in order to reduce the electrical noise from other circuitry (such as the front display). It allows you to enjoy Hi-Fi sound quality.

### 1 Press PURE DIRECT.

Each time you press the key, Pure Direct is enabled or disabled.



When Pure Direct is enabled, the following functions are not available.

- Some settings for the speakers or sound programs
- Operating the on-screen menu and “Option” menu
- Using the multi-zone function
- Viewing information on the front display (when not in operation)

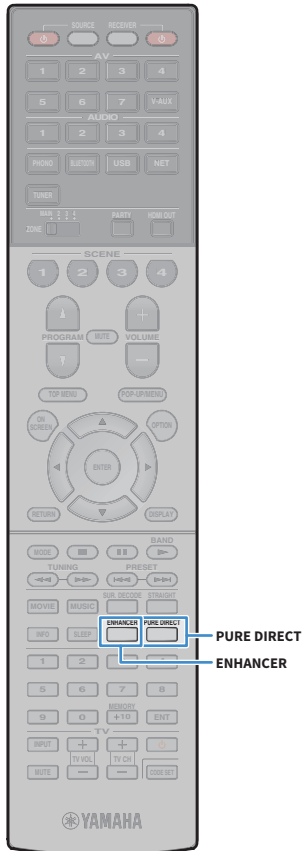

## Playing back digitally compressed formats (such as MP3, etc.) with enriched sound (Compressed Music Enhancer)

### compressed music ENHANCER

Compressed Music Enhancer adds depth and breadth to the sound, allowing you to enjoy a dynamic sound close to the original sound before it was compressed. This function can be used along with any other sound modes.

In addition, Compressed Music Enhancer enhances the quality of uncompressed digital audio (such as 2-channel PCM and FLAC) when “Hi-Res Mode” (p.125) in the “Option” menu is set to “On” (default).

### 1 Press ENHANCER.

Each time you press the key, Compressed Music Enhancer is enabled or disabled.



“ENHANCER” lights up



Compressed Music Enhancer does not work on the following audio sources.

- Signals whose sampling frequency is over 48 kHz
- DSD audio



You can also use “Enhancer” (p.125) in the “Option” menu to enable/disable Compressed Music Enhancer.

## Listening to FM/AM radio (China model only)

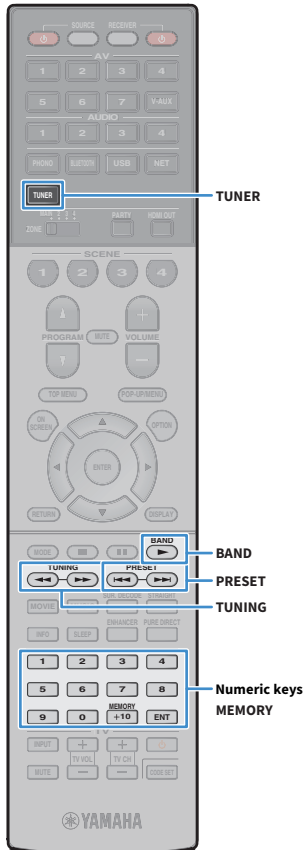

You can tune into a radio station by specifying its frequency or selecting from registered radio stations.



If you cannot obtain good reception on the radio, adjust the direction of the FM/AM antennas.

### Selecting a frequency for reception

1 Press TUNER to select “TUNER” as the input source.

2 Press BAND to select a band (FM or AM).



3 Use the following keys to set a frequency.

**TUNING:** Increase/decrease the frequency. Hold down the key for about a second to search stations automatically.

**Numeric keys:** Enter a frequency directly. For example, to select 98.50 MHz, press “9”, “8”, “5” and “0” (or ENT).



“TUNED” lights up when a signal is received from a radio station.

“STEREO” also lights up when a stereo signal is received.



“Wrong Station!” appears when you enter a frequency that is out of reception range.



You can switch between “Stereo” (stereo) and “Mono” (monaural) for FM radio reception in “FM Mode” (p.126) in the “Option” menu. When the signal reception for an FM radio station is unstable, switching to monaural may improve it.

### Registering favorite radio stations (presets)

You can register up to 40 radio stations as presets. Once you have registered stations, you can easily tune into them by selecting their preset numbers.



You can automatically register FM radio stations that have strong signals by using “Auto Preset” (p.94).

### Registering a radio station

Select a radio station manually and register it to a preset number.

1 Follow “Selecting a frequency for reception” (p.84) to tune into the desired radio station.

2 Hold down MEMORY for seconds.

The first time that you do register a station, the selected radio station will be registered to the preset number “01”. Thereafter, each radio station you select will be registered to the next empty (unused) preset number after the most recently registered number.

Preset number



To select a preset number for registering, press MEMORY once after tuning into the desired radio station, press PRESET to select a preset number, and then press MEMORY again.

“Empty” (not in use) or the frequency currently registered



## ■ Selecting a preset station

Tune into a registered radio station by selecting its preset number.

- 1 Press **TUNER** to select “TUNER” as the input source.
- 2 Press **PRESET** repeatedly to select the desired radio station.

You can also enter a preset number (01 to 40) directly by using the numeric keys after pressing PRESET once.



- “No Presets” appears when no radio stations are registered.
- “Wrong Num.” appears when an invalid number is entered.
- “Empty” appears when a preset number not in use is entered.



To clear preset stations, use “Clear Preset” or “Clear All Preset” (p.94).

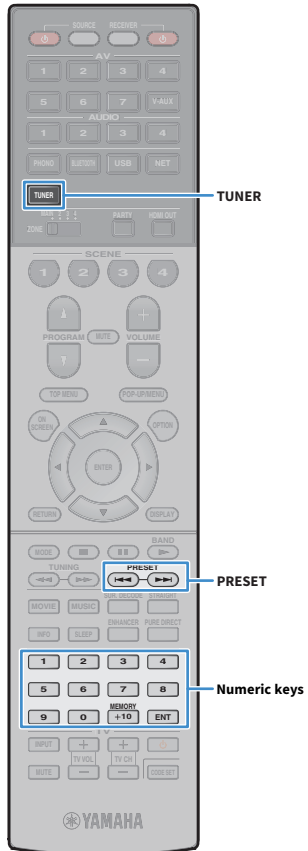

## Operating the radio on the TV

You can view the radio information or select a radio station on the TV.

- 1 Press TUNER to select “TUNER” as the input source.

The playback screen is displayed on the TV.

### Playback screen



- 1 **Radio station information**

Displays the information of the selected radio station such as the selected band (FM/AM) and frequency.

- 2 **TUNED/STEREO indicators**

“TUNED” lights up when a signal is received from a radio station.

“STEREO” lights up when a stereo signal is received.

- 3 **Operation menu**

Press the cursor key (▶) and then use the cursor keys (▲/▼) to select an item. Press ENTER to confirm the selection.

Menu	Function
<b>Browse</b>	Moves to the browse screen (preset station list).
<b>Screen Off</b>	Closes the screen display and shows the background. Press one of the menu operation keys to redisplay it.

### Browse screen

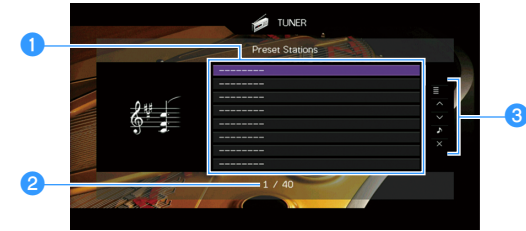

- 1 **Preset station list**

Displays the list of preset stations. Use the cursor keys (▲/▼) to select a preset station and press ENTER to tune into it.

- 2 **Preset number**

- 3 **Operation menu**

Press the cursor key (▶) and then use the cursor keys (▲/▼) to select an item. Press ENTER to confirm the selection.

To close the submenu, press RETURN.

Menu	Submenu	Function
<b>Utility</b>	Memory	Registers the current station to the preset number selected in the list.
	Auto Preset	Automatically registers FM radio stations with strong signals (up to 40 stations).
	Clear Preset	Clear the preset station selected in the list.
	Clear All Preset	Clear all the preset stations.
<b>1 Page Up</b>		Moves to the previous/next page of the list.
<b>1 Page Down</b>		
<b>Now Playing</b>		Moves to the playback screen.
<b>Screen Off</b>		Closes the screen display and shows the background. Press one of the menu operation keys to redisplay it.

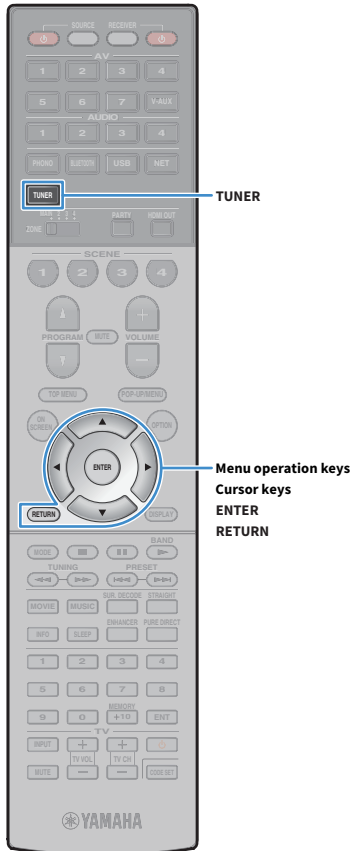

## Listening to DAB radio (Australia model only)

DAB (Digital Audio Broadcasting) uses digital signals for clearer sound and more stable reception compared to analog signals. The unit can also receive DAB+ (an upgraded version of DAB) that allows for more stations using MPEG-4 audio codec (AAC+), which has a more efficient transmission method.



- The unit supports Band III (174 to 240 MHz) only.
- Be sure to check the DAB coverage in your area in that not all areas are currently being covered. For a list of nationwide DAB statuses and worldwide DAB frequencies, check WorldDMB online at <http://www.worlddab.org/>.



For details on the antenna connection, see “Connecting the radio antennas” (p.48).

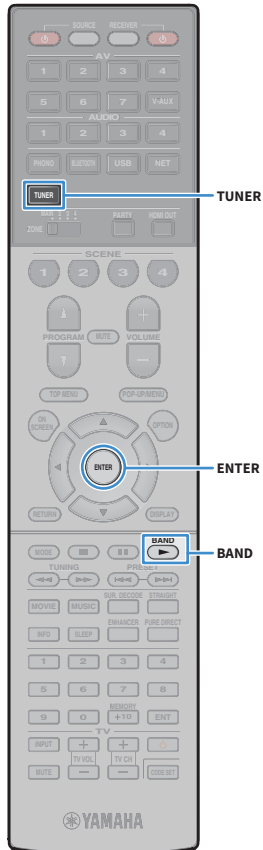

## Preparing the DAB tuning

Before tuning into DAB radio stations, follow the procedure below to perform an initial scan.

- 1 Press **TUNER** to select “TUNER” as the input source.
- 2 Press **BAND** to select the DAB band.

The following message appears on the front panel if you have not performed an initial scan yet.



- 3 Press **ENTER** to start an initial scan.



When the initial scan finishes, the unit automatically tunes into the first DAB radio station as stored in station order.



- If no DAB radio stations are found by an initial scan, the message in Step 1 appears again. Press **ENTER** to start an initial scan again.
- You can check reception strength of each DAB channel label (p.90).
- To perform an initial scan again after some DAB radio stations are stored, select “Init Scan” (p.122) in the “Option” menu. If you perform an initial scan again, the DAB radio stations currently registered to the preset numbers will be cleared.

## Selecting a DAB radio station for reception

You can select a DAB radio station from the stations stored by the initial scan.

- 1 Press TUNER to select “TUNER” as the input source.
- 2 Press BAND to select the DAB band.
- 3 Press TUNING repeatedly to select a DAB radio station.

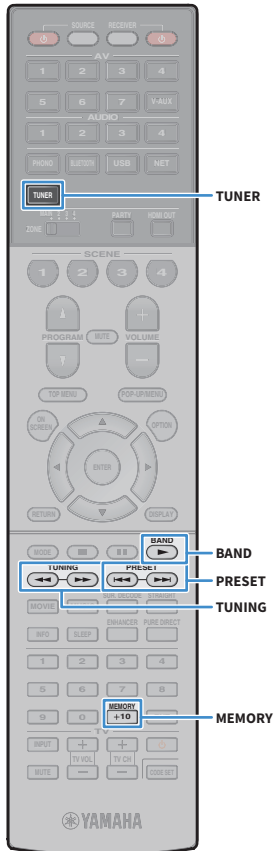

- “Off Air” appears when the selected DAB radio station is currently not available.
- When the unit is receiving a secondary station, “2” appears next to “DAB”.

Secondary station



You can watch videos input from external devices while listening to radio by selecting the video input jack in “Video Out” (p.126) in the “Option” menu.

## Registering favorite DAB radio stations (presets)

You can register up to 40 DAB radio stations as presets. Once you have registered stations, you can easily tune into them by selecting their preset numbers.



You can register up to 40 favorite radio stations each for DAB and FM bands.

### ■ Registering a DAB radio station as presets

Select a DAB radio station and register it to a preset number.

- 1 Follow “Selecting a DAB radio station for reception” (p.88) to tune into the desired DAB radio station.
- 2 Hold down MEMORY for seconds.

The first time that you do register a station, the selected radio station will be registered to the preset number “01”. Thereafter, each radio station you select will be registered to the next empty (unused) preset number after the most recently registered number.

Preset number



To select a preset number for registering, press MEMORY once after tuning into the desired DAB radio station, press PRESET to select a preset number, and then press MEMORY again.

“Empty” (not in use) or “Overwrite?” (in use)





## Selecting a preset DAB radio station

Tune into a registered DAB radio station by selecting its preset number.

- 1 Press **TUNER** to select “TUNER” as the input source.
- 2 Press **BAND** to select the DAB band.
- 3 Press **PRESET** repeatedly to select the desired DAB radio station.

You can also enter a preset number (01 to 40) directly by using the numeric keys after pressing PRESET once.



- “No Presets” appears when no DAB radio stations are registered.
- “Wrong Num.” appears when an invalid number is entered.
- “Empty” appears when a preset number not in use is entered.



To clear preset stations, use “Clear Preset” or “Clear All Preset” (p.86).

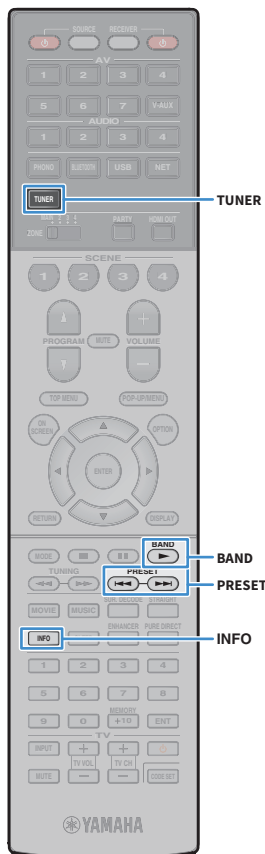

## Displaying the DAB information

The unit can receive various types of DAB information when it is tuned into a DAB radio station.

- 1 Tune into the desired DAB radio station.
- 2 Press **INFO**.

Each time you press the key, the displayed item changes.



Item name

About 3 seconds later, the corresponding information for the displayed item appears.



Information

<b>DLS (Dynamic Label Segment)</b>	Information on the current station
<b>Ensemble Label</b>	Ensemble name
<b>Program Type</b>	Station genre
<b>Date And Time</b>	Current date and time
<b>Audio Mode</b>	Audio mode (monaural/stereo) and bit rate
<b>CH Label/Freq.</b>	Channel label and frequency
<b>Signal Quality</b>	Signal reception quality (0 [none] to 100 [best])
<b>DSP Program</b>	Sound mode name
<b>Audio Decoder</b>	Decoder name



Some information may not be available depending on the selected DAB radio station.

## Checking reception strength of each DAB channel label

You can check reception strength of each DAB channel label (0 [none] to 100 [best]).

- 1 Press TUNER to select “TUNER” as the input source.
- 2 Press BAND to select the DAB band.
- 3 Press OPTION.
- 4 Use the cursor keys to select “Tune AID” and press ENTER.
- 5 Use the cursor keys (◀/▶) to select the desired DAB channel label.



- 6 To exit from the menu, press OPTION.

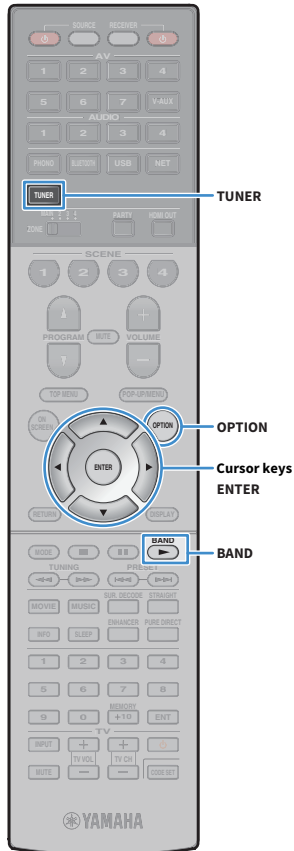

## DAB frequency information

The unit supports Band III (174 to 240 MHz) only.

Frequency	Channel label
174.928 MHz	5A
176.640 MHz	5B
178.352 MHz	5C
180.064 MHz	5D
181.936 MHz	6A
183.648 MHz	6B
185.360 MHz	6C
187.072 MHz	6D
188.928 MHz	7A
190.640 MHz	7B
192.352 MHz	7C
194.064 MHz	7D
195.936 MHz	8A
197.648 MHz	8B
199.360 MHz	8C
201.072 MHz	8D
202.928 MHz	9A
204.640 MHz	9B
206.352 MHz	9C
208.064 MHz	9D
209.936 MHz	10A
211.648 MHz	10B
213.360 MHz	10C
215.072 MHz	10D
216.928 MHz	11A
218.640 MHz	11B
220.352 MHz	11C
222.064 MHz	11D
223.936 MHz	12A

Frequency	Channel label
225.648 MHz	12B
227.360 MHz	12C
229.072 MHz	12D
230.784 MHz	13A
232.496 MHz	13B
234.208 MHz	13C
235.776 MHz	13D
237.488 MHz	13E
239.200 MHz	13F

## Listening to FM radio (Australia model only)

You can tune into a radio station by specifying its frequency or selecting from registered radio stations.



If you cannot obtain good reception on the radio, adjust the direction of the DAB/FM antennas.

### Selecting a frequency for reception

1 Press TUNER to select “TUNER” as the input source.

2 Press BAND to select the FM band.



3 Use the following keys to set a frequency.

**TUNING:** Increase/decrease the frequency. Hold down the key for about a second to search stations automatically.

**Numeric keys:** Enter a frequency directly. For example, to select 98.50 MHz, press “9”, “8”, “5” and “0” (or ENT).



“TUNED” lights up when a signal is received from a radio station.

“STEREO” also lights up when a stereo signal is received.



“Wrong Station!” appears when you enter a frequency that is out of reception range.



You can switch between “Stereo” (stereo) and “Mono” (monaural) for FM radio reception in “FM Mode” (p.126) in the “Option” menu. When the signal reception for an FM radio station is unstable, switching to monaural may improve it.

### Registering favorite FM radio stations (presets)

You can register up to 40 FM radio stations as presets. Once you have registered stations, you can easily tune into them by selecting their preset numbers.



You can automatically register FM radio stations that have strong signals by using “Auto Preset” (p.94).

### Registering a radio station

Select a radio station manually and register it to a preset number.

1 Follow “Selecting a frequency for reception” (p.92) to tune into the desired radio station.

2 Hold down MEMORY for seconds.

The first time that you do register a station, the selected radio station will be registered to the preset number “01”. Thereafter, each radio station you select will be registered to the next empty (unused) preset number after the most recently registered number.

Preset number



To select a preset number for registering, press MEMORY once after tuning into the desired radio station, press PRESET to select a preset number, and then press MEMORY again.

“Empty” (not in use) or the frequency currently registered

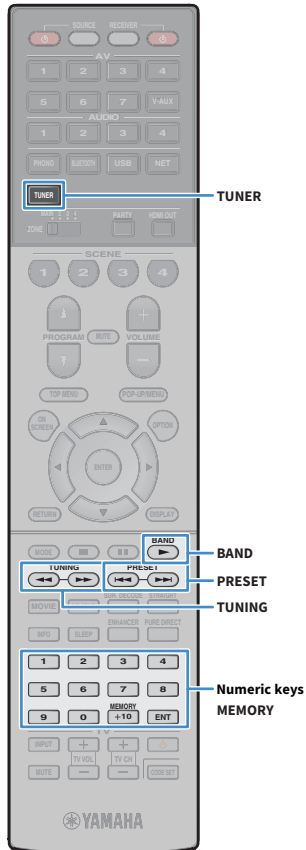

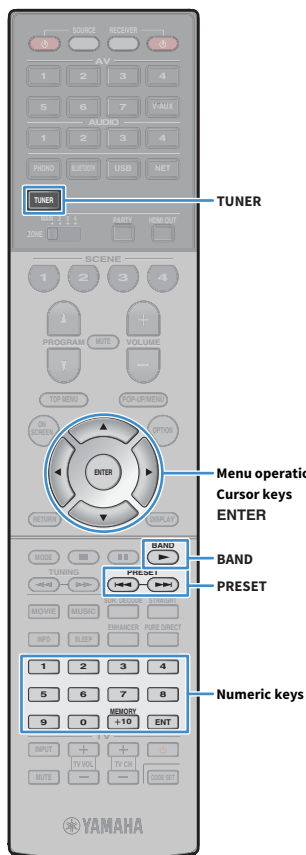

## ■ Selecting a preset station

Tune into a registered radio station by selecting its preset number.

- 1 Press TUNER to select “TUNER” as the input source.
- 2 Press BAND to select the FM band
- 3 Press PRESET repeatedly to select the desired radio station.

You can also enter a preset number (01 to 40) directly by using the numeric keys after pressing PRESET once.



- “No Presets” appears when no radio stations are registered.
- “Wrong Num.” appears when an invalid number is entered.
- “Empty” appears when a preset number not in use is entered.



To clear preset stations, use “Clear Preset” or “Clear All Preset” (p.94).

## ■ Operating the radio on the TV

You can view the radio information or select a radio station on the TV.

- 1 Press TUNER to select “TUNER” as the input source.  
The playback screen is displayed on the TV.

## ■ Playback screen

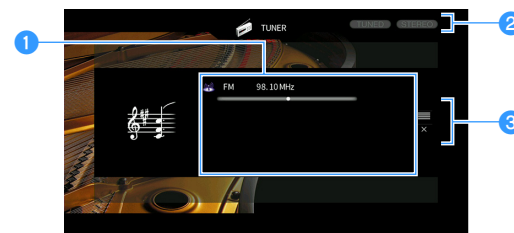

### 1 Radio station information

Displays the information of the selected radio station such as the selected band (DAB/FM) and frequency.

### 2 TUNED/STEREO indicators

“TUNED” lights up when a signal is received from a radio station.

“STEREO” lights up when a stereo signal is received.

### 3 Operation menu

Press the cursor key (▶) and then use the cursor keys (▲/▼) to select an item. Press ENTER to confirm the selection.

Menu	Function
Browse	Moves to the browse screen (preset station list).
Screen Off	Closes the screen display and shows the background. Press one of the menu operation keys to redisplay it.

## Browse screen

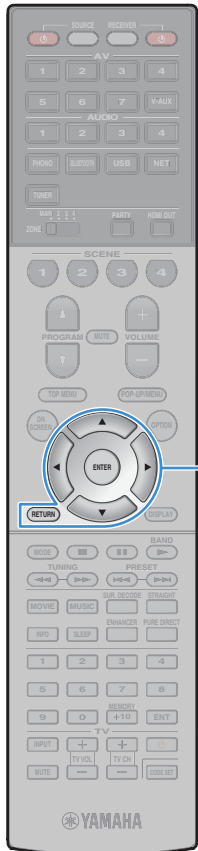

Menu operation keys  
Cursor keys  
ENTER  
RETURN

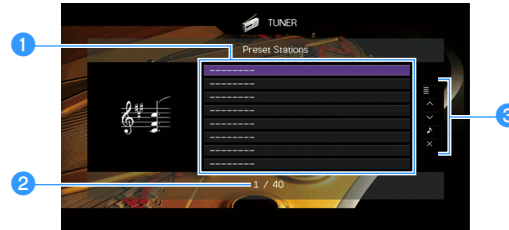

### 1 Preset station list

Displays the list of preset stations. Use the cursor keys (▲/▼) to select a preset station and press ENTER to tune into it.

### 2 Preset number

### 3 Operation menu

Press the cursor key (▶) and then use the cursor keys (▲/▼) to select an item. Press ENTER to confirm the selection.

To close the submenu, press RETURN.

Menu	Submenu	Function
<b>Utility</b>	Memory	Registers the current station to the preset number selected in the list.
	Auto Preset	Automatically registers FM radio stations with strong signals (up to 40 stations).
	Clear Preset	Clear the preset station selected in the list.
	Clear All Preset	Clear all the preset stations.
<b>1 Page Up</b>		Moves to the previous/next page of the list.
<b>1 Page Down</b>		
<b>Now Playing</b>		Moves to the playback screen.
<b>Screen Off</b>		Closes the screen display and shows the background. Press one of the menu operation keys to redisplay it.

## Playing back music via Bluetooth

You can play back music files stored on a Bluetooth device (such as smartphones) on the unit. Also, you can enjoy audio played back on the unit using Bluetooth speakers/headphones.

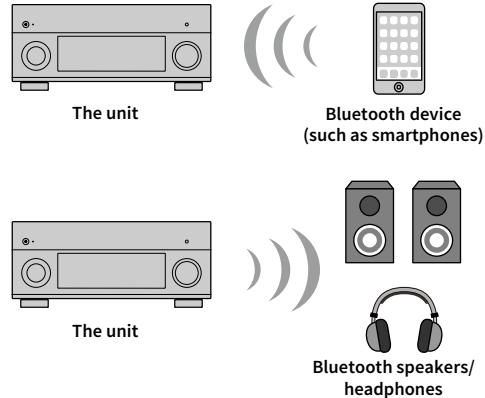
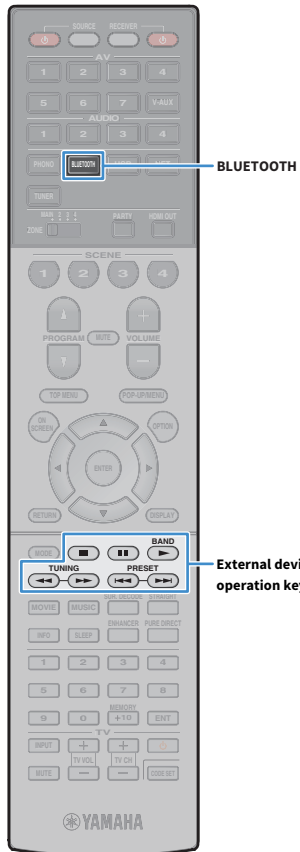

- To use the Bluetooth function, set “Bluetooth” (p.152) in the “Setup” menu to “On”.
- You cannot make Bluetooth connections to a Bluetooth device (such as smartphones) and Bluetooth speakers/headphones at the same time.
- Stand the wireless antenna upright for connecting to a Bluetooth device wirelessly. For details, see “Preparing the wireless antenna” (p.50).



For details on supported Bluetooth devices, see “Supported devices and file formats” (p.186).

## Playing back Bluetooth device music on the unit

Follow the procedure below to establish a Bluetooth connection between a Bluetooth device (such as smartphones) and the unit, and play back music stored the Bluetooth device on the unit.



The unit does not support video playback via Bluetooth.

- 1** Press **BLUETOOTH** to select “Bluetooth” as the input source.
- 2** On the Bluetooth device, select the unit (network name of the unit) from the available device list.

A connection between the Bluetooth device and the unit will be made.

If the pass key is required, enter the number “0000”.

- 3** On the Bluetooth device, select a song and start playback.

The playback screen (artist name, album name and song title) is displayed on the TV.



- If the unit detects the Bluetooth device previously connected, the unit automatically connects to the Bluetooth device after Step 1. To establish another Bluetooth connection, first terminate the current Bluetooth connection.
- To terminate the Bluetooth connection, perform one of the following operations.
  - Perform the disconnect operation on the Bluetooth device.
  - Select an input source other than “Bluetooth” on the unit.
  - Select “Disconnect” in “Setup menu items” (p.137) in the “Setup” menu.
- You can use the external device operation keys (▶, ■, ■, ◀, ▶▶) on the remote control to control playback.

## Enjoying audio using Bluetooth speakers/headphones

Follow the procedure below to establish a Bluetooth connection between Bluetooth speakers/headphones and the unit, and enjoy audio played back on the unit using Bluetooth speakers/headphones.



- To use this function, set “Transmitter” (p.153) in the “Setup” menu to “On”.
- AirPlay and DSD audio cannot be delivered.

- 1 Use the input selection keys (except BLUETOOTH) to select an input source.
- 2 Press ON SCREEN.
- 3 Use the cursor keys and ENTER to select “Setup” → “Bluetooth” → “Audio Send” → “Device Search” and “OK”.

The list of available Bluetooth devices (BD addresses) is displayed.

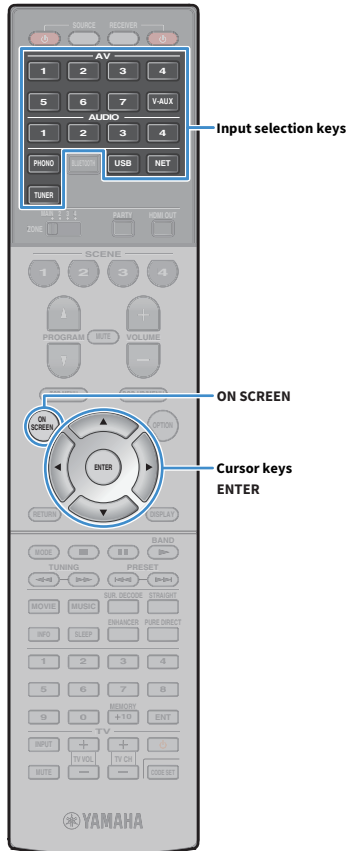
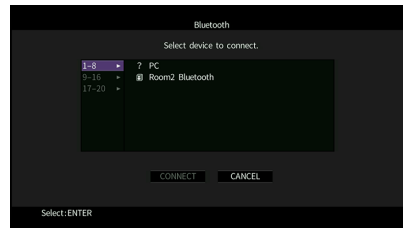

- 4 Use the cursor keys and ENTER to check the desired Bluetooth speakers/headphones.

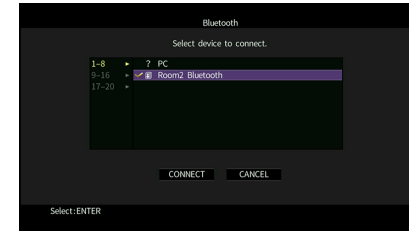

The checkmark indicates the Bluetooth device currently selected.

- 5 While the Bluetooth speakers/headphones are in the pairing mode, use the cursor keys to select “CONNECT” and press ENTER.

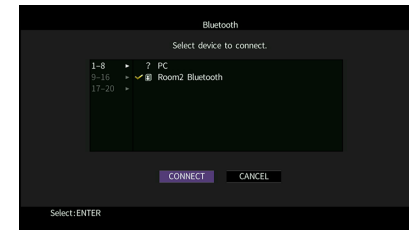

When the connection process finishes, audio played back on the unit will be reproduced from the Bluetooth speakers/headphones.

- 6 To exit from the menu, press ON SCREEN.



To terminate the Bluetooth connection, perform the disconnect operation on the Bluetooth speakers/headphones.



- AirPlay and DSD audio cannot be delivered.
- When the Pure Direct mode is enabled, input sources other than the network sources and USB cannot be delivered.



# Playing back music stored on a USB storage device

You can play back music files stored on a USB storage device on the unit.

The unit supports USB mass storage class devices (FAT16 or FAT32 format).



For details on playable file formats, see “Supported devices and file formats” (p.186).

## Connecting a USB storage device

### 1 Connect the USB storage device to the USB jack.

The unit (front)

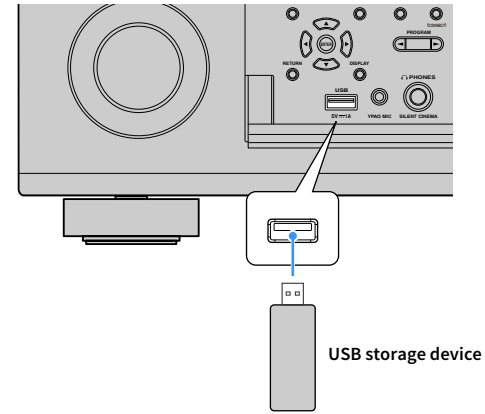

If the USB storage device contains many files, it may take time to load them. In this case, “Loading...” appears in the front display.



- Stop playback of the USB storage device before disconnect it from the USB jack.
- Connect a USB memory device directly to the USB jack of the unit. Do not use extension cables.
- The unit cannot charge USB devices while it is in standby mode.

## Playback of USB storage device contents

Follow the procedure below to operate the USB storage device contents and start playback.

You can control the USB memory device with the menu displayed on the TV screen.

### 1 Press USB to select “USB” as the input source.

The browse screen is displayed on the TV.



If playback is ongoing on your USB storage device, the playback screen is displayed.

### 2 Use the cursor keys to select an item and press ENTER.

If a song is selected, playback starts and the playback screen is displayed.

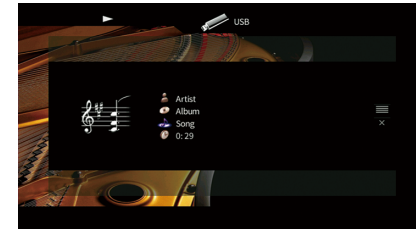

- To return to the previous screen, press RETURN.
- To return to the top screen during menu operations on the browse screen, hold down RETURN.
- Files not supported by the unit cannot be selected.
- If the unit detects a series of unsupported files (such as images and hidden files) during playback, playback stops automatically.
- You can register your favorite items as shortcuts and access them directly by selecting the shortcut numbers (p.116).

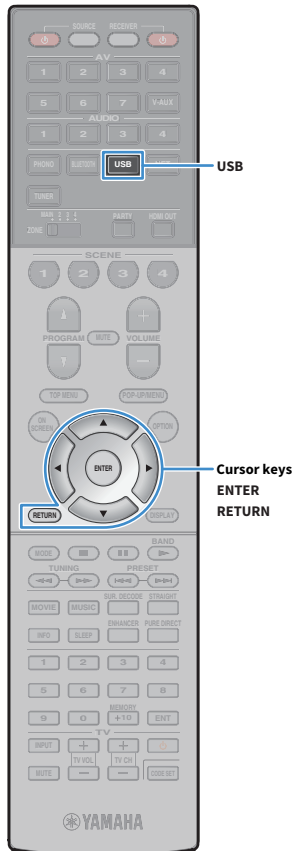



## Browse screen

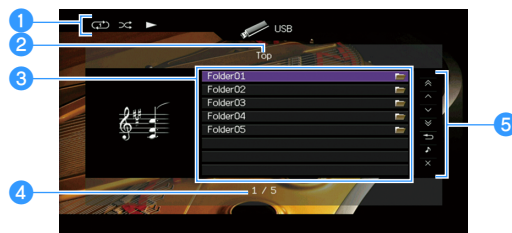

### 1 Status indicators

Display the current shuffle/repeat settings (p.100) and playback status (such as play/pause).

### 2 List name

### 3 Contents list

Displays the list of USB storage device contents. Use the cursor keys (▲/▼) to select an item and press ENTER to confirm the selection.

### 4 Item number/total

### 5 Operation menu

Press the cursor key (▶) and then use the cursor keys (▲/▼) to select an item. Press ENTER to confirm the selection.

Menu	Function
<b>1 Page Up</b>	Moves to the previous/next page of the list.
<b>1 Page Down</b>	
<b>10 Pages Up</b>	Moves 10 pages forward/backward.
<b>10 Pages Down</b>	
<b>Return</b>	Returns to the higher-level list.
<b>Now Playing</b>	Moves to the playback screen.
<b>Screen Off</b>	Closes the screen display and shows the background. Press one of the menu operation keys to redisplay it.

## Playback screen

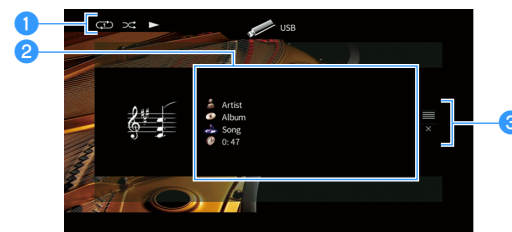

### 1 Status indicators

Display the current shuffle/repeat settings (p.100) and playback status (such as play/pause).

### 2 Playback information

Displays the artist name, album name, song title, and elapsed time. Use the cursor keys (▲/▼) to select scrollable information.

### 3 Operation menu

Press the cursor key (▶) and then use the cursor keys (▲/▼) to select an item. Press ENTER to confirm the selection.

Menu	Function
<b>Browse</b>	Moves to the browse screen.
<b>Screen Off</b>	Closes the screen display and shows the background. Press one of the menu operation keys to redisplay it.



You can use the external device operation keys (▶, ■, ■, ◀, ▶▶) on the remote control to control playback.

## ■ Shuffle/repeat settings



You can configure the shuffle/repeat settings for playback of USB storage device contents.

- 1 When “USB” is selected as the input source, press **OPTION**.
- 2 Use the cursor keys to select “Shuffle” (Shuffle) or “Repeat” (Repeat) and press **ENTER**.



- To return to the previous screen during menu operations, press **RETURN**.
- Texts in parentheses denote indicators on the front display.

- 3 Use the cursor keys (◀/▶) to select a setting.

Item	Setting	Function
<b>Shuffle (Shuffle)</b>	Off (Off)	Turns off the shuffle function.
	On (On)	Plays back songs in the current album (folder) in random order. “  ” appears on the TV screen.
<b>Repeat (Repeat)</b>	Off (Off)	Turns off the repeat function.
	One (One)	Plays back the current song repeatedly. “  ” appears on the TV screen.
	All (All)	Plays back all songs in the current album (folder) repeatedly. “  ” appears on the TV screen.

- 4 To exit from the menu, press **OPTION**.

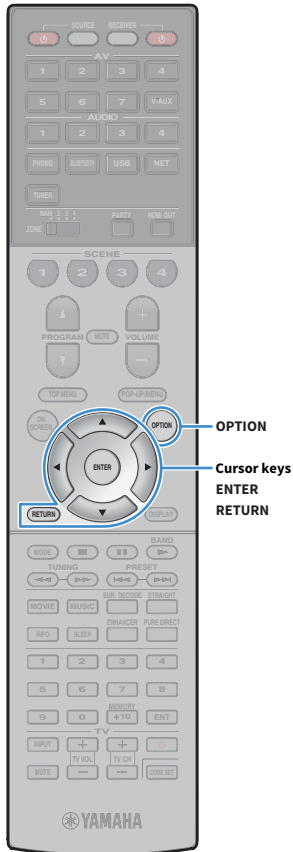

## Playing back music stored on media servers (PCs/NAS)

You can play back music files stored on your PC or DLNA-compatible NAS on the unit.



- To use this function, the unit and your PC must be connected to the same router (p.50). You can check whether the network parameters (such as the IP address) are properly assigned to the unit in “Network Connection” (p.150) in the “Information” menu.
- The audio may be interrupted while using the wireless network connection. In this case, use the wired network connection.



For details on playable file formats, see “Supported devices and file formats” (p.186).

### Media sharing setup

---

To play back music files stored on your PC or DLNA-compatible NAS, first you need to configure the media sharing setting on each music server.

#### ■ For a PC with Windows Media Player installed

The setting procedure may vary depending on the PC and Windows Media Player version (The following procedure is a setup example for Windows Media Player 12).

- 1 Start Windows Media Player 12 on your PC.
- 2 Select “Stream”, then “Turn on media streaming”.
- 3 Click “Turn on media streaming”.
- 4 Select “Allowed” from the drop-down list next to the unit’s model name.
- 5 Click “OK” to exit.



For details on media sharing settings, refer to Windows Media Player help.

#### ■ For a PC or a NAS with other DLNA server software installed

Refer to the instruction manual for the device or software and configure the media sharing settings.

## Playback of PC music contents

Follow the procedure below to operate the PC music contents and start playback.

You can control the PC/NAS with the menu displayed on the TV screen.

- 1 Press NET repeatedly to select “SERVER” as the input source.

The browse screen is displayed on the TV.

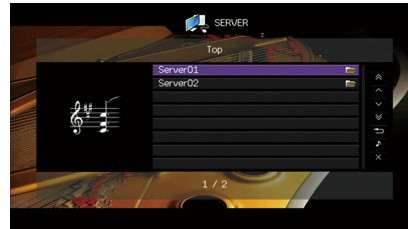

If playback of a music file selected from the unit is ongoing on your PC, the playback screen is displayed.

- 2 Use the cursor keys to select a music server and press ENTER.

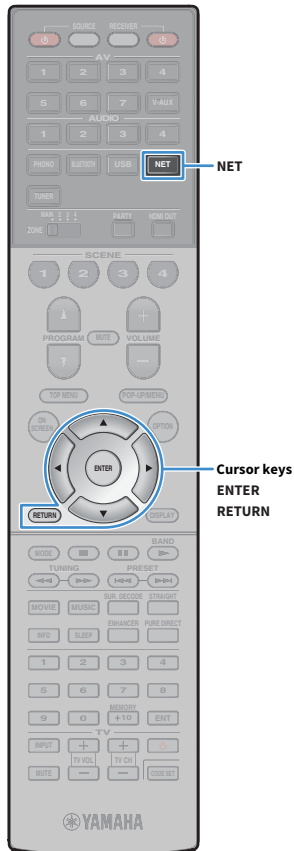

- 3 Use the cursor keys to select an item and press ENTER.

If a song is selected, playback starts and the playback screen is displayed.

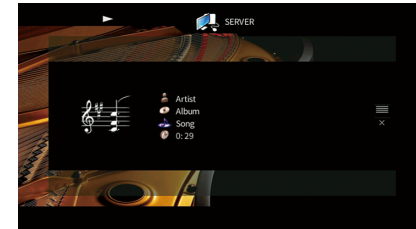

- To return to the previous screen, press RETURN.
- To return to the top screen during menu operations on the browse screen, hold down RETURN.
- Files not supported by the unit cannot be selected.
- If the unit detects a series of unsupported files (such as images and hidden files) during playback, playback stops automatically.
- You can register your favorite items as shortcuts and access them directly by selecting the shortcut numbers (p.116).



## Browse screen



### 1 Status indicators

Display the current shuffle/repeat settings (p.104) and playback status (such as play/pause).

### 2 List name

### 3 Contents list

Displays the list of PC content. Use the cursor keys (▲/▼) to select an item and press ENTER to confirm the selection.

### 4 Item number/total

### 5 Operation menu

Press the cursor key (▶) and then use the cursor keys (▲/▼) to select an item. Press ENTER to confirm the selection.

Menu	Function
<b>1 Page Up</b>	Moves to the previous/next page of the list.
<b>1 Page Down</b>	
<b>10 Pages Up</b>	Moves 10 pages forward/backward.
<b>10 Pages Down</b>	
<b>Return</b>	Returns to the higher-level list.
<b>Now Playing</b>	Moves to the playback screen.
<b>Screen Off</b>	Closes the screen display and shows the background. Press one of the menu operation keys to redisplay it.

## Playback screen

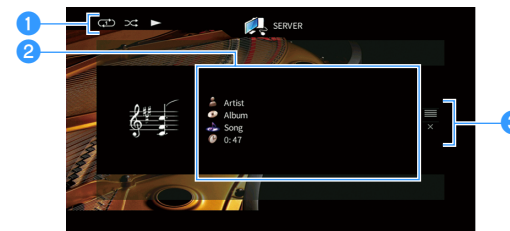

### 1 Status indicators

Display the current shuffle/repeat settings (p.104) and playback status (such as play/pause).

### 2 Playback information

Displays the artist name, album name, song title, and elapsed time. Use the cursor keys (▲/▼) to select scrollable information.

### 3 Operation menu

Press the cursor key (▶) and then use the cursor keys (▲/▼) to select an item. Press ENTER to confirm the selection.

Menu	Function
<b>Browse</b>	Moves to the browse screen.
<b>Screen Off</b>	Closes the screen display and shows the background. Press one of the menu operation keys to redisplay it.



- You can use the external device operation keys on the remote control to control playback (some functions may not work depending on the PC/NAS).
- You can also use a DLNA-compatible Digital Media Controller (DMC) to control playback. For details, see “DMC Control” (p.129).

## ■ Shuffle/repeat settings

You can configure the shuffle/repeat settings for the playback of PC music content.



**1** When “SERVER” is selected as the input source, press **OPTION**.

**2** Use the cursor keys to select “Shuffle” (Shuffle) or “Repeat” (Repeat) and press **ENTER**.



- To return to the previous screen during menu operations, press **RETURN**.
- Text in parentheses denotes indicators on the front display.

**3** Use the cursor keys (◀/▶) to select a setting.

Item	Setting	Function
<b>Shuffle (Shuffle)</b>	Off (Off)	Turns off the shuffle function.
	On (On)	Plays back songs in the current album (folder) in random order. “  ” appears on the TV screen.
<b>Repeat (Repeat)</b>	Off (Off)	Turns off the repeat function.
	One (One)	Plays back the current song repeatedly. “  ” appears on the TV screen.
	All (All)	Plays back all songs in the current album (folder) repeatedly. “  ” appears on the TV screen.

**4** To exit from the menu, press **OPTION**.

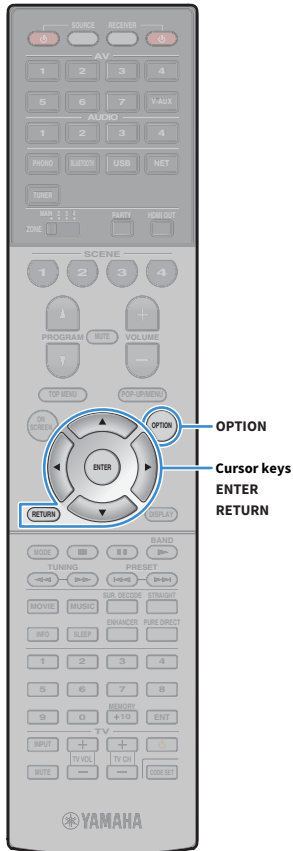



# Listening to Internet radio

You can listen to Internet radio stations from all over the world.



- To use this function, the unit must be connected to the Internet (p.50). You can check whether the network parameters (such as the IP address) are properly assigned to the unit in “Network” (p.150) in the “Information” menu.
- You may not be able to receive some Internet radio stations.
- The unit uses the airable.Radio service. airable is a service of Tune In GmbH.
- This service may be discontinued without notice.
- Folder names are different depending on the language.

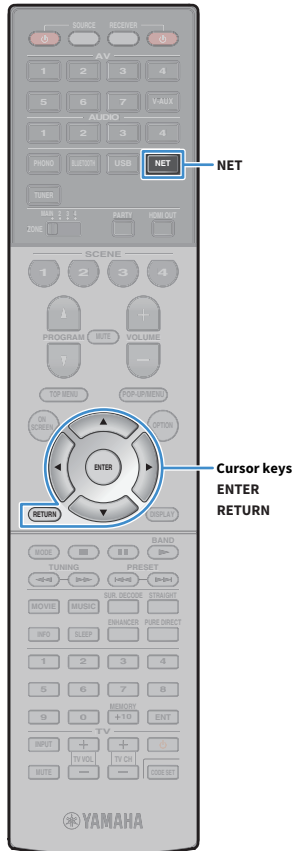

## Playback of Internet radio

- 1 Press NET repeatedly to select “NET RADIO” as the input source.

The browse screen is displayed on the TV.

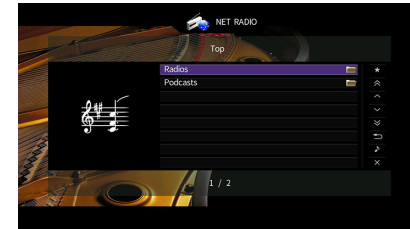

- 2 Use the cursor keys to select an item and press ENTER.

If an Internet radio station is selected, playback starts and the playback screen is displayed.

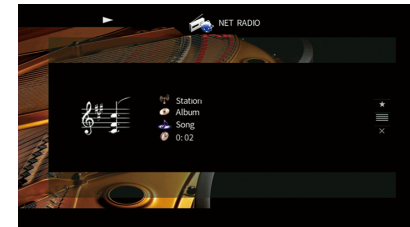

- To return to the previous screen, press RETURN.
- You can register your favorite items as shortcuts and access them directly by selecting the shortcut numbers (p.116).



## Browse screen



### 1 Playback indicator

### 2 List name

### 3 Contents list

Displays the list of Internet radio content. Use the cursor keys (▲/▼) to select an item and press ENTER to confirm the selection.

### 4 Item number/total

### 5 Operation menu

Press the cursor key (▶) and then use the cursor keys (▲/▼) to select an item. Press ENTER to confirm the selection.

Menu	Function
<b>Add to favorites (Remove from favorites)</b>	Adds/removes the station selected in the list to/from the “Favorites” folder (p.107).
<b>1 Page Up</b>	Moves to the previous/next page of the list.
<b>1 Page Down</b>	
<b>10 Pages Up</b>	Moves 10 pages forward/backward.
<b>10 Pages Down</b>	
<b>Return</b>	Returns to the higher-level list.
<b>Now Playing</b>	Moves to the playback screen.
<b>Screen Off</b>	Closes the screen display and shows the background. Press one of the menu operation keys to redisplay it.

## Playback screen



### 1 Playback indicator

### 2 Playback information

Displays the station name, album name, song title, and elapsed time. Use the cursor keys (▲/▼) to select scrollable information.

### 3 Operation menu

Press the cursor key (▶) and then use the cursor keys (▲/▼) to select an item. Press ENTER to confirm the selection.

Menu	Function
<b>Add to favorites</b>	Adds the current station to the “Favorites” folder (p.107).
<b>Browse</b>	Moves to the browse screen.
<b>Screen Off</b>	Closes the screen display and shows the background. Press one of the menu operation keys to redisplay it.



- You can use the external device operation key (■) on the remote control to stop playback.
- Some information may not be available depending on the station.

## Registering favorite Internet radio stations (Favorites)

By registering your favorite Internet radio stations to “Favorites”, you can quickly access to them from the “Favorites” folder in the browse screen.



You can also register up to 40 favorite USB and network contents or Bluetooth input source as shortcuts (p.116).

### ■ Registering the station on the browse/playback screen

- 1 Select the desired Internet radio station in the browse screen or start playback of it to display the playback screen.
- 2 Press the cursor key (▶) to select “Add to favorites” and press ENTER.

The selected station is added to the “Favorites” folder.

Radio stations registered to favorites are displayed with “★”.

#### Browse screen

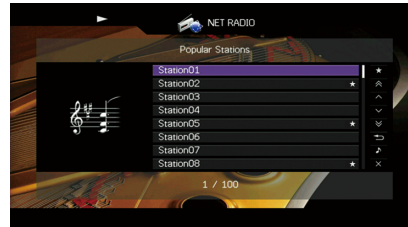

To remove a station that is registered to favorites, select the station and then select “Remove from favorites”.

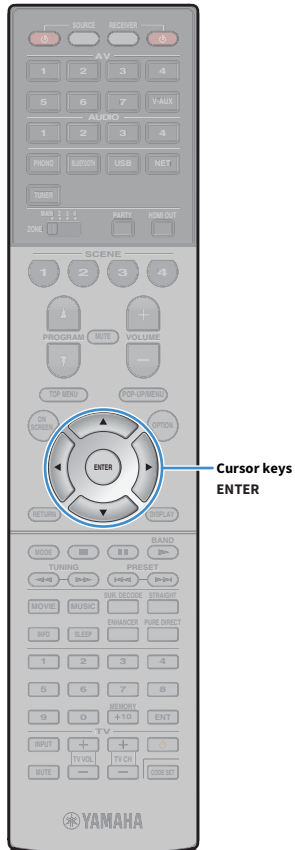

# Playing back iTunes/iPod music with AirPlay

The AirPlay function allows you to play back iTunes/iPod music on the unit via network.

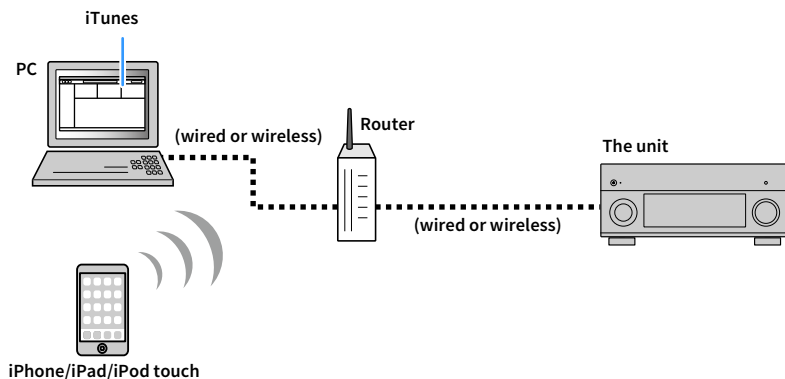

- To use this function, the unit and your PC or iPod must be connected to the same router. You can check whether the network parameters (such as the IP address) are properly assigned to the unit in “Network” (p.160) in the “Information” menu.
- When using a multiple SSID router, access to the unit might be restricted depending on the SSID to connect. Connect the iPod to the SSID which can access the unit.



- For details on supported iPod devices, see “Supported devices and file formats” (p.186).
- You can restrict access to the unit using the AirPlay Password (p.119).

## Playback of iTunes/iPod music contents

Follow the procedure below to play back iTunes/iPod music contents on the unit.

### 1 Turn on the unit, and start iTunes on the PC or display the playback screen on the iPod.

If the iTunes/iPod recognizes the unit, the AirPlay icon appears.

iTunes (example)



iOS 10 (example)

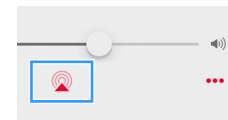

If the icon does not appear, check whether the unit and PC/iPod are connected to the router properly.

### 2 On the iTunes/iPod, click (tap) the AirPlay icon and select the unit (network name of the unit) as the audio output device.

### 3 Select a song and start playback.

The unit automatically selects “AirPlay” as the input source and starts playback.

The playback screen is displayed on the TV.



- You can turn on the unit automatically when starting playback on iTunes or iPod by setting “Network Standby” (p.151) in the “Setup” menu to “On”.
- You can edit the network name (the unit’s name on the network) displayed on iTunes/iPod in “Network Name” (p.152) in the “Setup” menu.
- You can adjust the unit’s volume from the iTunes/iPod during playback. To disable volume controls from iTunes/iPod, set “Volume Interlock” (p.129) in the “Input” menu to “Off”.

#### Caution

When you use iTunes/iPod controls to adjust volume, the volume may be unexpectedly loud. This could result in damage to the unit or speakers. If the volume suddenly increases during playback, stop playback on the iTunes/iPod immediately.

## ■ Playback screen



Menu operation keys  
Cursor keys  
ENTER

External device  
operation keys

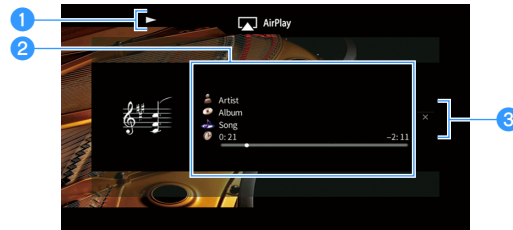

### 1 Playback indicator

### 2 Playback information

Displays the artist name, album name, song title, and elapsed/remaining time.  
Use the cursor keys (▲/▼) to select scrollable information.

### 3 Operation menu

Press the cursor key (▶) to select an item. Press ENTER to confirm the selection.

Menu	Function
Screen Off	Closes the screen display and shows the background. Press one of the menu operation keys to redisplay it.



You can use the external device operation keys (▶, ■, ■■, ◀◀, ▶▶) on the remote control to control playback.

## Playing back videos/audio in multiple rooms (multi-zone)

The multi-zone function allows you to play back different input sources in the room where the unit is installed (main zone) and in other rooms (Zone2, Zone3 and Zone4).

For example, while you are watching TV in the living room (main zone), another person can listen to PC music in the study room (Zone2), and another can listen to radio in the guest room (Zone3) and play DVD in the kitchen (Zone4).

- Audio signals that can be output to each zone vary depending on how you connect the device in each zone to the unit's output jacks. For details, see "Multi-zone output" (p.188).

### Multi-zone configuration examples

Since there are many possible ways to use the unit in a multi-zone configuration, we recommend that you consult with your nearest authorized Yamaha dealer or service center about the multi-zone connections that best meet your requirements.

#### Enjoying music in other rooms

You can enjoy music using speakers placed in other rooms.

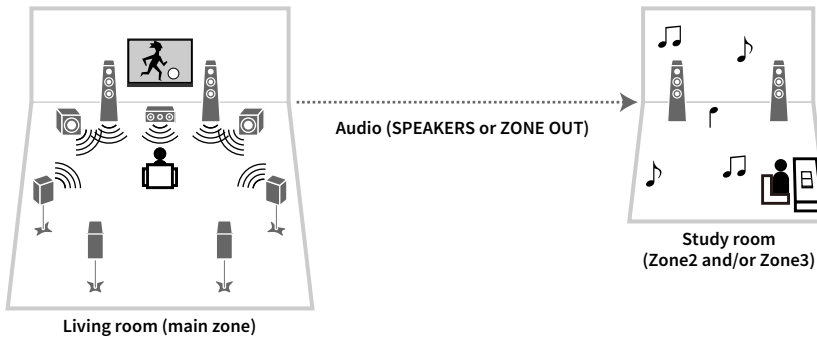

##### Connections

Speakers (connecting to the unit directly): p.39

Speakers (using an external amplifier): p.111

#### Enjoying videos/music in other rooms

You can enjoy videos/music using TVs placed in other rooms.

##### Enjoying videos/music using a TV and speakers

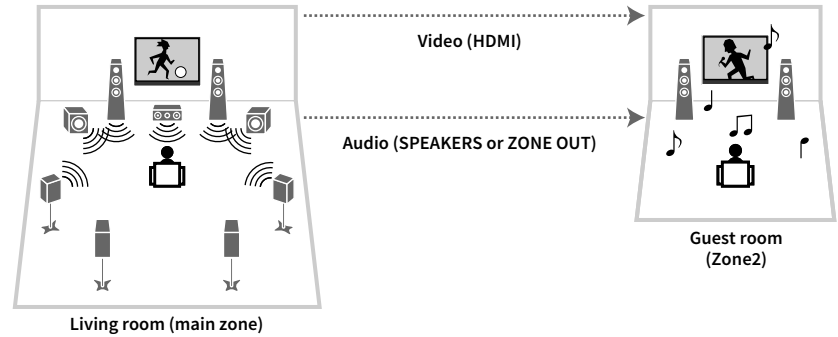

##### Connections

TV: p.112

Speakers (connecting to the unit directly): p.39

Speakers (using an external amplifier): p.111

##### Enjoying videos/music using only a TV

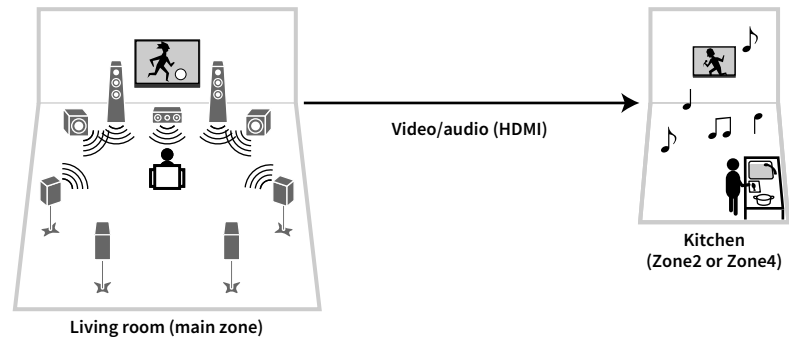

##### Connection

TV: p.112

## Preparing the multi zone system

Connect the device that will be used in other rooms to the unit.

### Caution

- Remove the unit's power cable from the AC wall outlet before connecting speakers or an external amplifier.
- Ensure that the bare wires of the speaker cable do not touch one another or come into contact with the unit's metal parts. Doing so may damage the unit or the speakers. If the speaker cables short circuit, "Check SP Wires" will appear on the front display when the unit is turned on.

## Connecting speakers to play back audio

Connect speakers to play back audio in Zone2 or Zone3. The connection method varies depending on the amplifier being used (the unit or an external amplifier).

### Using the unit's internal amplifier

Connect the speakers placed in Zone2 or Zone3 to the unit with speaker cables. For details, see "Connecting Zone2/3 speakers" (p.39).

### Using an external amplifier

Connect the external amplifier placed in Zone2 or Zone3 to the unit with a stereo pin cable and connect speakers to the external amplifier.

The unit (rear)

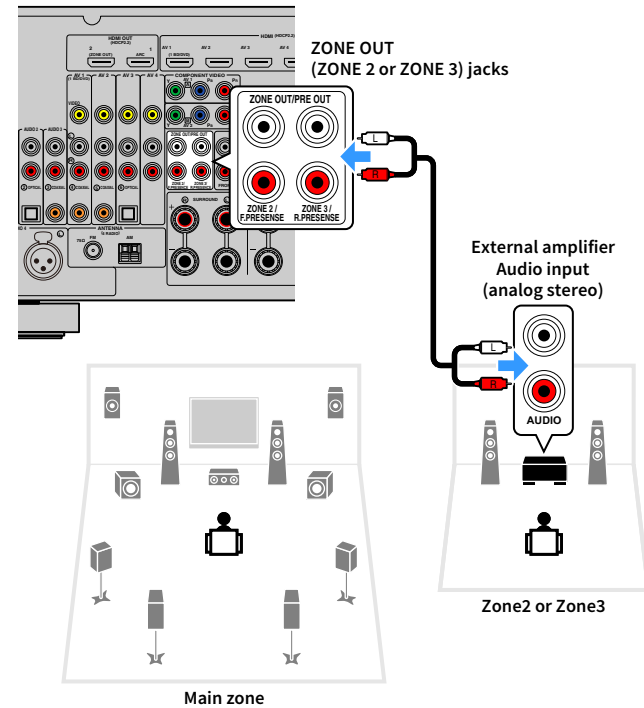

(RX-V3083 only)

You cannot use an external amplifier for Zone2 when the ZONE OUT/PRE OUT jacks are set to output front presence channel audio in "Power Amp Assign" (p.140) in the "Setup" menu. Also, you cannot use an external amplifier for Zone3 when the ZONE OUT/PRE OUT jacks are configured to output rear presence channel audio.



You can adjust the volume for Zone2 and Zone3 output with the unit. When using an external amplifier with volume control, set "Volume" (p.154) in the "Setup" menu to "Fixed".

## ■ Connecting an HDMI-compatible device to play back videos/audio

Connect an HDMI-compatible device (such as a TV) to play back videos/audio at Zone2 or Zone4. If you connect an AV amplifier, you can enjoy multichannel playback in another room (Zone4).



- To watch videos played back on a video device at Zone2 or Zone4, you need to connect the video device to the unit with an HDMI cable (p.44).
- We recommend that you disable HDMI Control on the playback devices connected to the unit.
- On-screen menu operations are not available for Zone2 and Zone4.

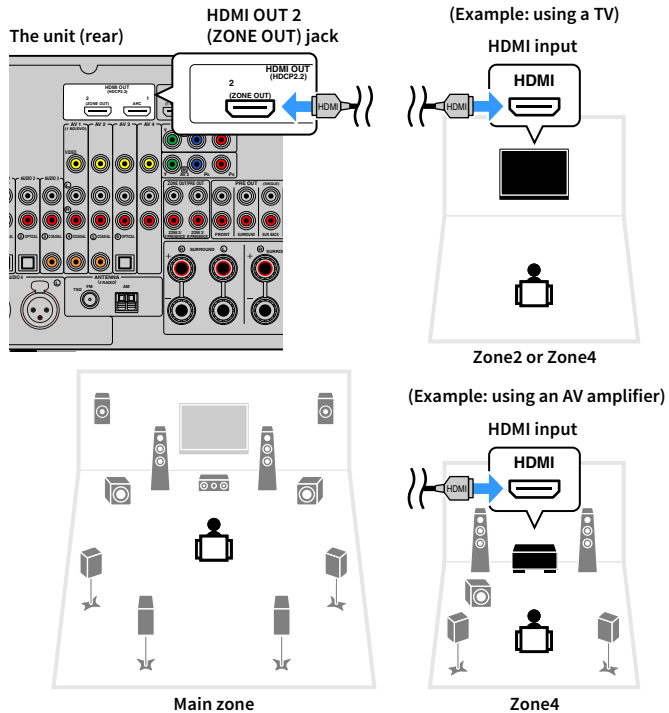

To assign the HDMI OUT 2 (ZONE OUT) jack to Zone2 or Zone4, set "HDMI OUT2 Assign" (p.155) in the "Setup" menu to "Zone2" or "Zone4".



- When the HDMI OUT 2 (ZONE OUT) jack is assigned to Zone2, you can enable/disable the audio output from the HDMI OUT 2 jack by setting "Zone2 - Audio Output" (p.155) in the "Setup" menu to "On" or "Off" (default).
- You can also use speakers placed in Zone2 to output audio (p.39).

- Videos/audio interruptions may happen in another zone when any of the following operations is performed.
  - Tuning on/off a TV connected to the unit via HDMI or switching the TV input
  - Enabling/disabling a zone output or selecting its input source
  - Changing the sound mode or audio settings



## Operating the unit from another room (remote connection)

You can operate the unit and external devices from Zone2, Zone3 or Zone4 using the supplied remote control if you connect an infrared signal receiver/emitter to the unit's REMOTE IN/OUT jacks.



To operate external devices with the supplied remote control, you must register a remote control code for each device before using (p.166).

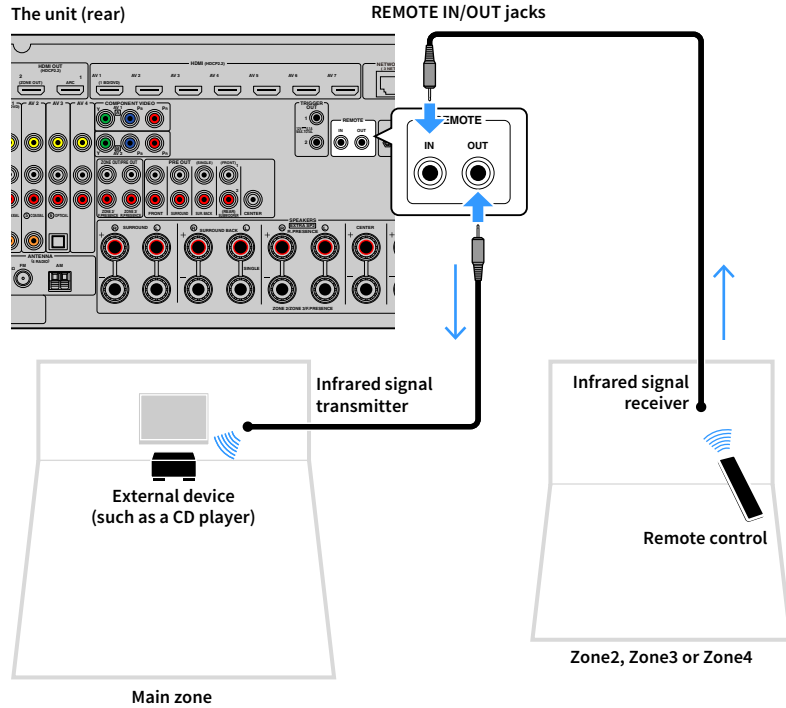

## Remote connections between Yamaha products

An infrared signal transmitter is not required if you are using Yamaha products that support remote connections, as the unit does. You can transmit remote control signals by connecting the REMOTE IN/OUT jacks with monaural mini-jack cables and an infrared signal receiver.

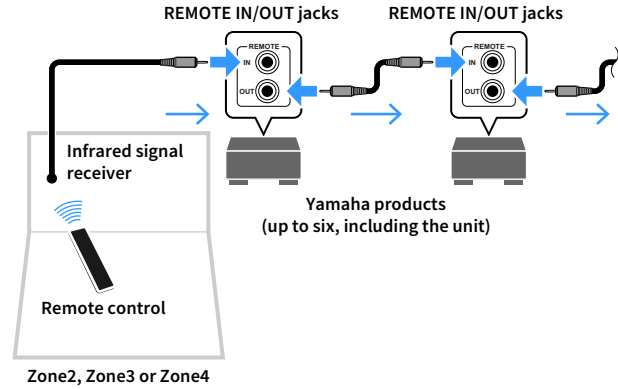

## Controlling Zone2, Zone3 or Zone4

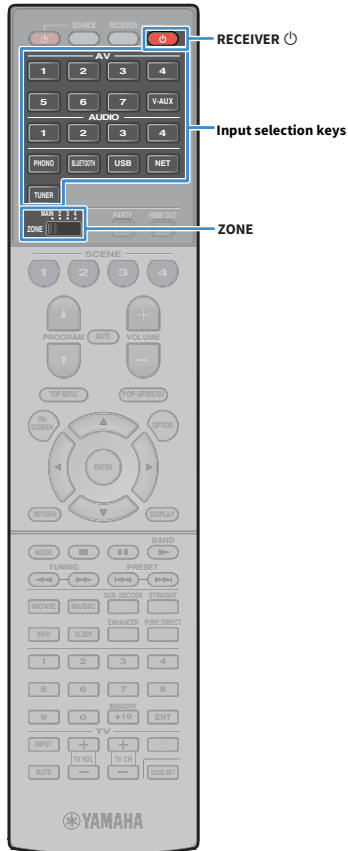

**1** Use the ZONE switch to select a zone.

**2** Press RECEIVER .

Each time you press the key, the selected zone is enabled or disabled.

When zone audio output is enabled, the corresponding zone indicator lights up in the front display.

**3** Use the input selection keys to select an input source.



- Audio signals that can be output to each zone vary depending on how you connect the device in each zone to the unit's output jacks. For details, see "Multi-zone output" (p.188).
- You cannot select Bluetooth, USB and network sources exclusively for each zone. For example, if you select "SERVER" for Zone2 when "USB" is selected for the main zone, the input source for the main zone also switches to "SERVER".

**4** Start playback on the external device or select a radio station.

Refer to the instruction manual for the external device.

For details on the following operations, see the corresponding pages.

- Listening to FM/AM radio (China model only) (p.84)
- Listening to DAB radio (Australia model only) (p.87)
- Listening to FM radio (Australia model only) (p.92)
- Playing back music via Bluetooth (p.95)
- Playing back music stored on a USB storage device (p.97)
- Playing back music stored on media servers (PCs/NAS) (p.101)
- Listening to Internet radio (p.105)
- Playing back iTunes/iPod music with AirPlay (p.108)



- You can also use the web control (p.117) to control Zone2, Zone3 or Zone4.
- AirPlay is available in Zone2 and Zone3 only when AirPlay playback is ongoing in the main zone.



- The Zone2/Zone3 input automatically switches in conjunction with the input source selected in the main zone when "Main Zone Sync" is selected as the Zone2/Zone3 input with the web control (p.117) or AV CONTROLLER (p.12).
- To play back DSD audio in Zone2/Zone3, select "Main Zone Sync" as the Zone2/Zone3 input or use the party mode (p.115).

### Caution

To avoid unexpected noise, never play back DTS-CDs in Zone2, Zone3 or Zone4.

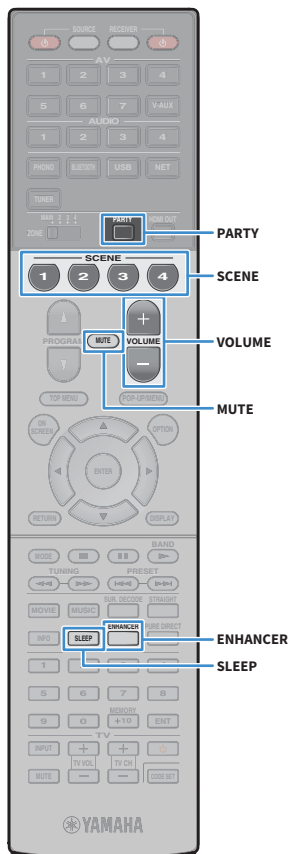

## ■ Other operations for Zone2, Zone3 or Zone4

The following functions are also available when the zone you want to operate is enabled.

### Adjusting the volume (for Zone2 and Zone3 only)

Press VOLUME or MUTE.

### Selecting the input source and settings at once (SCENE)

Press SCENE.



To register the current settings (input source, volume and tone control) to a scene, hold down the desired SCENE key until “SET Complete” appears on the front display. (Only an input source can be registered for Zone4.)

### Setting the sleep timer

Press SLEEP repeatedly to set the time (120 min, 90 min, 60 min, 30 min, off).

### Playing back digitally compressed formats (such as MP3, etc.) with enriched sound (Compressed Music Enhancer)

Press ENHANCER.

## ■ Enjoying the same source in multiple rooms (party mode)

The party mode allows you to play back in all zones the same music that is being played back in the main zone. During the party mode, stereo playback is automatically selected for all zones. Utilize this function when you want to use main zone music as background music for a house party.

### 1 Press PARTY.

Each time you press the key, the party mode is turned on or off.

When the party mode is turned on, “PARTY” lights up in the front display.



You can select the zones to be included in the party mode in “Party Mode Set” (p.155) in the “Setup” menu.



Zone4 output is available only when an HDMI input is selected in the main zone.

## Registering favorite items (shortcut)

You can register up to 40 favorite USB and network contents or Bluetooth input source as shortcuts and access them directly by selecting the shortcut numbers.



- You can also use the “Favorites” feature to register Internet radio stations (p.107).
- Only the input source will be registered for Bluetooth and AirPlay. Individual contents cannot be registered.

## Registering an item

Select a desired item and register it to a shortcut number.

- 1 Play back a song or a radio station to be registered.
- 2 Press MEMORY.



Shortcut number (flashes)



To change a shortcut number to which the item will be registered, use numeric keys to select the shortcut number after Step 2.



“Empty” (not in use) or item currently registered

- 3 To confirm the registration, press MEMORY.



## Recalling a registered item

Recall a registered item by selecting the shortcut number.

- 1 Press BLUETOOTH, USB or NET.
- 2 Use the numeric keys to enter a shortcut number (01 to 40).

You can also use PRESET on the front panel to select a shortcut.



- “No Presets” appears when no items are registered.
- “Empty” appears when a preset number not in use is entered.
- The registered item cannot be recalled in the following cases.
  - The USB storage device which contains the registered item is not connected to the unit.
  - The PC/NAS which contains the registered item is turned off or not connected to the network.
  - The registered network content is temporarily unavailable or out of service.
  - The registered item (file) has been deleted or moved to another location.
  - A Bluetooth connection cannot be established.
- When you register music files stored on a USB storage device or a PC/NAS, the unit memorizes the relative position of the music files in the folder. If you have added or deleted any music files to or from the folder, the unit may not recall the music file correctly. In such cases, register the items again.
- The registered content (songs and Internet radio stations) can be displayed as a list and easily recalled by using MusicCast CONTROLLER (p.74) on your mobile device.

# Controlling the unit from a web browser (web control)

You can control the unit with the web control screen displayed in a web browser.

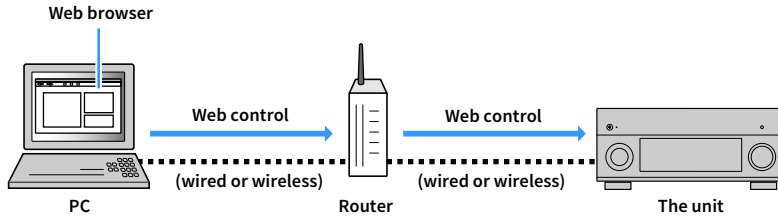

- To use this function, the unit and your PC must be connected to the same router.
- Some security software installed on your PC may block the access of the unit to your PC. In these cases, configure the security software appropriately.
- To display the web control screen or turn on the unit from the web control when the unit is in standby mode, set “Network Standby” (p.119) to “On”.
- We recommend using one of the following web browsers.
  - Internet Explorer 11.x
  - Safari 9.x

**1** Start the web browser.

**2** Enter the IP address of the unit in the address bar of the web browser.

(Example)

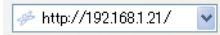

- You can check the IP address of the unit in “Network” (p.160) in the “Information” menu.
- You can bookmark the unit’s IP address in the browser or create a shortcut link (p.119) to access the web control screen quickly in the future. However, if you are using a DHCP server, the IP address of the unit may change each time the unit is turned on.
- If you have enabled the MAC Address Filter (p.151), you need to specify the MAC address of your PC to allow the PC to access the unit. For information on how to check the MAC address of your PC, refer to its instruction manual.
- By using the application for smartphone/tablet “AV CONTROLLER”, you can control the unit from an iPhone, iPad, iPod touch or Android devices (p.12).

## Top menu screen

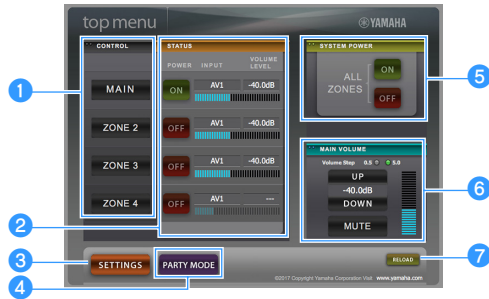

- 1 CONTROL**  
Moves to the control screen for the selected zone.
- 2 STATUS**  
Turns on/off the power for each zone or displays the input source and volume set for each zone.
- 3 SETTINGS**  
Moves to the settings screen.
- 4 PARTY MODE**  
Turns on/off the party mode (p.115).
- 5 SYSTEM POWER**  
Turns on/off the power for all zones.
- 6 MAIN VOLUME**  
Adjusts the volume or mutes the audio output for the main zone. You can also select the increments used for volume adjustment.
- 7 RELOAD**  
Reloads the current status of the unit.

## Control screen



- 1 PLAY INFO**  
Selects an input source or controls playback for the selected zone.
  - 2 TOP MENU**  
Moves to the top menu screen.
  - 3 SCENE**  
Selects a scene for the selected zone.
  - 4 POWER**  
Turns on/off the power for the selected zone.
  - 5 VOLUME**  
Adjusts the volume or mutes the audio output for the selected zone. You can also select the increments used for volume adjustment.
  - 6 RELOAD**  
Reloads the current status of the unit.
- !**
- Multi-zone volume adjustment is not available when an external amplifier is used.
  - Multi-zone volume adjustment on the web control may not work on the unit depending on the unit's settings.

# Settings screen

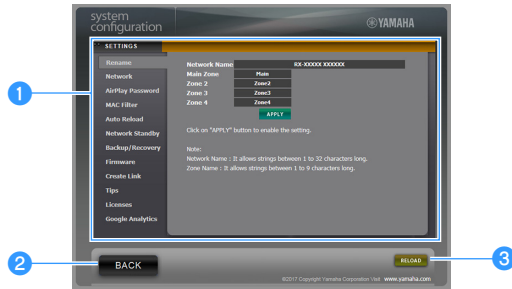

## 1 Rename

Edits the network name (the unit's name on the network) (p.152) or the name of each zone (p.153). Click "APPLY" to apply the changes to the unit.

## Network

Selects the network connection method (p.150) or configures the network parameters (such as IP address) (p.150). Click "APPLY" to apply the changes to the unit.

## AirPlay Password

Sets the password to restrict access to the unit via AirPlay (p.108). Click "APPLY" to apply the changes to the unit.

## MAC Filter

Sets the MAC address filter (p.151) to limit access to the unit from the network devices. Click "APPLY" to apply the changes to the unit.

## Auto Reload

Enables/disables automatic reloading. When "Auto Reload" is "On" (enabled), the web control screen reloads the status of the unit every 5 seconds.

## Network Standby

Enables/disables the network standby function (p.151).

## Backup/Recovery

Creates a backup of the unit's settings on the PC or restores the settings from the backup.

## Firmware

Updates the firmware of the unit by using the firmware you have downloaded on the PC. Follow the on-screen instructions to start the firmware update.

## Create Link

Creates a shortcut link to the desired control screen.

## Tips

Displays tips for use of the web control.

## Licenses

Displays the licenses of the software used in the unit.

## Google Analytics

Displays an explanation of data collection by Google Analytics. Data collection can be enabled or disabled at any time.

## 2 BACK

Moves to the top menu screen.

## 3 RELOAD

Reloads the current status of the unit.

### Note

- If the network settings are changed, you may need to restart the browser or regain access to the unit.
- When using the MAC address filter, make sure you specify the MAC addresses of your network devices correctly. Otherwise, the unit will be inaccessible from your network devices such as PCs and other external devices.
- Do not operate the unit during the recovery process, as this may result in the incorrect recovery of the settings. When the recovery finishes, click "OK" to set the unit to standby mode.
- The backup does not contain user information (such as user account and password) or unit-specific information (such as MAC address and IP address).
- Some characters entered with a PC may not appear correctly on the unit.

## Viewing the current status

You can view the current status (input or DSP program currently selected) on the front panel display or TV.

## Switching information on the front display

- 1 Press INFO repeatedly to select between the various display items.



Item name

About 3 seconds after a display item is selected, its corresponding information appears.



Information



Available items vary depending on the selected input source. The displayed item can also be applied separately to each input source group.

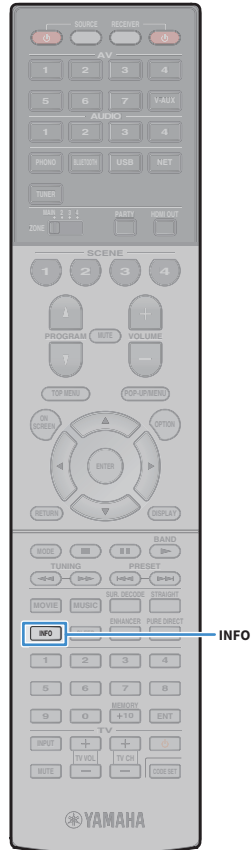

Currently input source	Item
<b>AV 1-7</b>	
<b>VIDEO AUX</b>	DSP Program (sound mode name), Audio Decoder (decoder name <sup>*2</sup> )
<b>AUDIO 1-4<sup>*1</sup></b>	
<b>PHONO</b>	
<b>TUNER (FM/AM)</b>	(AM radio feature is not available on the Australia model) DSP Program (sound mode name), Audio Decoder (decoder name <sup>*2</sup> )
<b>TUNER (DAB)</b>	(Australia model only) See "Displaying the DAB information" (p.89) for details.
<b>Bluetooth</b>	Song (song title), Artist (artist name), Album (album name), DSP Program (sound mode name), Audio Decoder (decoder name <sup>*2</sup> )
<b>USB</b>	Song (song title), Artist (artist name), Album (album name), DSP Program (sound mode name), Audio Decoder (decoder name <sup>*2</sup> )
<b>SERVER</b>	Song (song title), Artist (artist name), Album (album name), DSP Program (sound mode name), Audio Decoder (decoder name <sup>*2</sup> ), IP Address (IP address), Ethernet MAC (Ethernet MAC address), Wi-Fi MAC (Wi-Fi MAC address)
<b>AirPlay</b>	Song (song title), Album (album name), Station (station name), DSP Program (sound mode name), Audio Decoder (decoder name <sup>*2</sup> ), IP Address (IP address), Ethernet MAC (Ethernet MAC address), Wi-Fi MAC (Wi-Fi MAC address)
<b>NET RADIO</b>	Song (song title), Album (album name), Station (station name), DSP Program (sound mode name), Audio Decoder (decoder name <sup>*2</sup> ), IP Address (IP address), Ethernet MAC (Ethernet MAC address), Wi-Fi MAC (Wi-Fi MAC address)
<b>MusicCast Link</b>	DSP Program (sound mode name), Audio Decoder (decoder name <sup>*2</sup> ), IP Address (IP address), Ethernet MAC (Ethernet MAC address), Wi-Fi MAC (Wi-Fi MAC address)

<sup>\*1</sup> AUDIO 4: RX-V3083 only

<sup>\*2</sup> The name of the audio decoder currently activated is displayed. If no audio decoder is activated, "Decoder Off" appears.



## Viewing the status information on the TV

### 1 Press DISPLAY.

The following information is displayed on the TV.

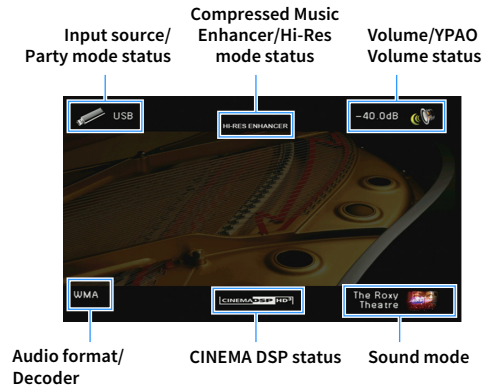

### 2 To close the information display, press DISPLAY.

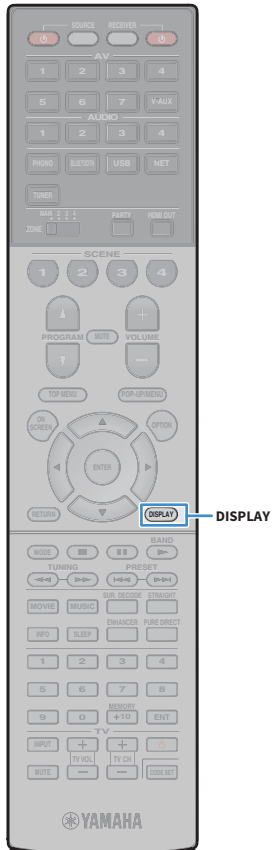

# Configuring playback settings for different playback sources (Option menu)

You can configure separate playback settings for different playback sources. This menu is available on the front panel (or on the TV screen), allowing you to easily configure settings during playback.

## 1 Press OPTION.

### Front display



### TV screen

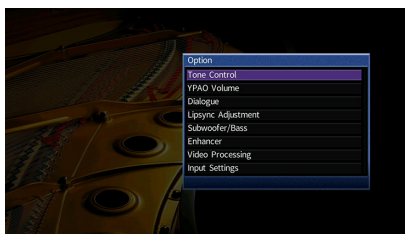

## 2 Use the cursor keys to select an item and press ENTER.



To return to the previous screen during menu operations, press RETURN.

## 3 Use the cursor keys (◀/▶) to select a setting.

## 4 To exit from the menu, press OPTION.

## Option menu items



- Available items vary depending on the selected input source.
- Text in parentheses denotes indicators on the front display.
- Default settings are underlined.

Item	Function	Page
<b>Tone Control</b> ( <b>Tone Control</b> )	Adjusts the level of high-frequency range and low-frequency range individually.	123
<b>YPAO Volume</b> ( <b>YPAO Volume</b> )	<b>YPAO Volume</b> ( <b>YPAO Vol.</b> )	Enables/disables YPAO Volume. 123
	<b>Adaptive DRC</b> ( <b>A.DRC</b> )	Sets whether the dynamic range (from maximum to minimum) is automatically adjusted when the volume is adjusted. 123
<b>Dialogue</b> ( <b>Dialog</b> )	<b>Dialogue Level</b> ( <b>Dialog Lvl</b> )	Adjusts the volume of dialogue sounds. 124
	<b>DTS Dialogue Control</b> ( <b>DTS Dialog</b> )	Adjusts the volume of dialogue sounds for DTS:X contents. 124
	<b>Dialogue Lift</b> ( <b>Dialog Lift</b> )	Adjusts the perceived height of dialogue sounds. 124
<b>Lipsync Adjustment</b> ( <b>Lipsync Adj.</b> )	Adjusts the delay between video and audio output. 124	
<b>Subwoofer/Bass</b> ( <b>Subwoofer/Bass</b> )	<b>Subwoofer Trim</b> ( <b>SW.Trim</b> )	Fine-adjusts the subwoofer volume. 124
	<b>Extra Bass</b> ( <b>Extra Bass</b> )	Enables/disables Extra Bass. 124
<b>Enhancer</b> ( <b>Enhancer</b> )	<b>Enhancer</b> ( <b>Enhancer</b> )	Enables/disables Compressed Music Enhancer. 125
	<b>Hi-Res Mode</b> ( <b>HiRes Mode</b> )	Enables/disables the high-resolution mode (for enhancing the quality of uncompressed digital audio). 125
<b>Video Processing</b> ( <b>Video Process.</b> )	<b>Video Mode</b> ( <b>V.M</b> )	Enables/disables the video signal processing settings configured in the "Setup" menu. 125
	<b>Video Adjustment</b> ( <b>Video Adjust</b> )	Selects a video adjustment setting from presets. 125

Item	Function	Page
Input Settings (Input Settings)	<b>Input Trim (In.Trim)</b> Corrects volume differences between input sources.	126
	<b>Audio Select (A.Sel)</b> Selects the audio input jack to use when more than one audio connection is made for one input source.	126
	<b>Video Out (V.Out)</b> Selects a video to be output with the audio input source.	126
<b>FM Mode (FM Mode)</b>	Switches between stereo and monaural for FM radio reception.	126
<b>Init Scan (Init Scan)</b>	(Australia model only) Performs an initial scan for DAB radio reception.	87
<b>Tune AID (Tune AID)</b>	(Australia model only) Checks reception strength of each DAB channel label.	90
<b>Shuffle (Shuffle)</b>	Configures the shuffle setting for the USB storage device (p.100) or media server (p.104).	—
<b>Repeat (Repeat)</b>	Configures the repeat setting for the USB storage device (p.100) or media server (p.104).	—

## Tone Control (Tone Control)

Adjusts the level of high-frequency range (Treble) and low-frequency range (Bass) individually.

### Choices

Treble (Treble), Bass (Bass)

### Setting range

-6.0 dB to 0.0 dB to +6.0 dB, 0.5 dB increments



- When both “Treble” and “Bass” are 0.0 dB, “Bypass” appears.
- If you set an extreme value, sounds may not match those from other channels.



You can also adjust the “Tone Control” setting with the front panel controls by pressing TONE CONTROL repeatedly to select “Treble” or “Bass”, and PROGRAM to make an adjustment.

## YPAO Volume (YPAO Volume)

Enables/disables YPAO Volume or Adaptive DRC.

### YPAO Volume (YPAO Vol.)

Enables/disables YPAO Volume. When YPAO Volume is enabled, the high- and low-frequency levels are automatically adjusted according to the volume so that you can enjoy natural sounds even at low volume.

#### Settings

Off (Off) Disables YPAO Volume.

On (On) Enables YPAO Volume.



- YPAO Volume works effectively after the measurement results of “Auto Setup” have been already saved (p.54).
- We recommend enabling both YPAO Volume and Adaptive DRC when you are listening at lower volumes or at night.

### Adaptive DRC (A.DRC)

Sets whether the dynamic range (from maximum to minimum) is automatically adjusted when the volume level is adjusted. When it is set to “On”, it is useful for listening to playback at a low volume at night.

#### Settings

Off (Off) The dynamic range is not automatically adjusted.

On (On) Automatically adjusts the dynamic range when YPAO Volume is enabled.

If “On” is selected, the dynamic range becomes narrow at a low volume and wide at a high volume.

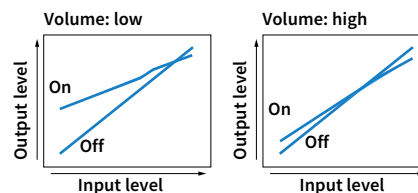

## Dialogue (Dialog)

Adjusts the volume or perceive height of dialogue sounds.

### Dialogue Level (Dialog Lvl)

Adjusts the volume of dialogue sounds. If dialogue sounds cannot be heard clearly, you can turn up its volume by increasing this setting.

#### Setting range

0 to 3



This setting is not available when DTS:X content is played back, or when the Dolby Surround or Neural:X decoder is working.

### DTS Dialogue Control (DTS Dialog)

Adjusts the volume of dialogue sounds for DTS:X contents.

#### Setting range

0 to 6



This setting is available only when DTS:X content which supports the DTS Dialogue Control feature is played back.

### Dialogue Lift (Dialog Lift)

Adjusts the perceived height of dialogue sounds. If the dialogue sounds as if it is coming from below the TV screen, you can raise its perceived height by increasing this setting.



This setting is available only when one of the following conditions is met.

- One of the sound programs (except for 2ch Stereo and 9ch Stereo) is selected when front presence speakers are used.
- Virtual Presence Speaker (VPS) (p.79) is working.  
(You may hear dialogue sounds from the surround speakers depending on the listening position.)

#### Setting range

0 to 5 (The bigger the value the higher the position)

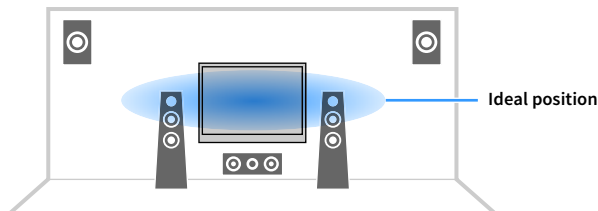

## Lipsync Adjustment (Lipsync Adj.)

Adjusts the delay between video and audio output.

#### Setting range

0 ms to 500 ms (1 ms increments)



This setting is available only when "Delay Enable" (p.145) in the "Setup" menu is set to "Enable" (default).

## Subwoofer/Bass (Subwoofer/Bass)

Adjust the subwoofer volume or bass sound.

### Subwoofer Trim (SW.Trim)

Fine-adjusts the subwoofer volume.

#### Setting range

-6.0 dB to 0.0 dB to +6.0 dB (0.5 dB increments)

### Extra Bass (Extra Bass)

Enables/disables Extra Bass. When Extra Bass is enabled, you can enjoy enhanced bass sounds, regardless of the size of the front speakers and the presence or absence of the subwoofer.

#### Settings

Off (Off)	Disables Extra Bass.
On (On)	Enables Extra Bass.

## ■ Enhancer (Enhancer)

Enables/disables Compressed Music Enhancer and the high-resolution mode.

### Enhancer (Enhancer)

Enables/disables Compressed Music Enhancer (p.83).



- This setting is applied separately to each input source.
- You can also use ENHANCER on the remote control to enable/disable Compressed Music Enhancer (p.83).

#### Settings

Off (Off)	Disables Compressed Music Enhancer.
On (On)	Enables Compressed Music Enhancer.

#### Default

TUNER, Bluetooth, USB, (network sources): On (On)

Others: Off (Off)



Compressed Music Enhancer does not work on the following audio sources.

- Signals whose sampling frequency is over 48 kHz
- DSD audio

### Hi-Res Mode (HiRes Mode)

Enables/disables the high-resolution mode when “Enhancer” is set to “On”. If this function is set to “On”, you can enhance the quality of uncompressed digital audio (such as 2-channel PCM and FLAC) using Compressed Music Enhancer.

#### Settings

On (On)	Enables the high-resolution mode. (The high-resolution mode may not work depending on the audio signal processing condition.)
Off (Off)	Disables the high-resolution mode.

## ■ Video Processing (Video Process.)

Configures the video signal processing settings.

### Video Mode (V.M)

Enables/disables the video signal processing (resolution, aspect ratio and video adjustments) settings configured in “Processing” (p.147) in the “Setup” menu.

#### Settings

Direct (Direct)	Disables the video signal processing.
Processing (Processing)	Enables the video signal processing.

### Video Adjustment (Video Adjust)

Selects a video adjustment setting from presets you have configured in “Adjustment” (p.145) in the “Setup” menu.



This setting is applied separately to each input source.

#### Settings

1 to 6

## Input Settings (Input Settings)

Configures the input settings.



This setting is applied separately to each input source.

### Input Trim (In.Trim)

Corrects volume differences between input sources. If you are bothered by volume differences when switching between input sources, use this function to correct it.

#### Setting range

-6.0 dB to 0.0 dB to +6.0 dB (0.5 dB increments)

### Audio Select (A.Sel)

Selects the audio input jack to use when more than one audio connection is made for one input source.

#### Settings

<u>Auto (Auto)</u>	Automatically selects the audio input jack in the following priority order. 1. HDMI input 2. Digital input (COAXIAL or OPTICAL) 3. Analog input (AUDIO)
HDMI (HDMI)	Always selects HDMI input. No sounds are produced when no signals are input through the HDMI jack.
Coax/Opt (Coax/Opt)	Always selects digital input (COAXIAL or OPTICAL). No sounds are produced when no signals are input through the COAXIAL or OPTICAL jack.
Analog (Analog)	Always selects analog input (AUDIO). No sounds are produced when no signals are input through the AUDIO jacks.

### Video Out (V.Out)

Selects a video to be output with the audio input source.

#### Settings

<u>Off (Off)</u>	Does not output video.
AV 1-7 (AV1-7), VIDEO AUX (V-AUX)	Outputs video input through the corresponding video input jacks.

## FM Mode (FM Mode)

Switches between stereo and monaural for FM radio reception.

#### Settings

<u>Stereo (Stereo)</u>	Receives FM radio in stereo sounds.
Mono (Mono)	Receives FM radio in monaural sounds.

# CONFIGURATIONS

## Configuring input sources (Input menu)

You can change the input source settings using the TV screen.

**1** Press ON SCREEN.

**2** Use the cursor keys to select “Input” and press ENTER.

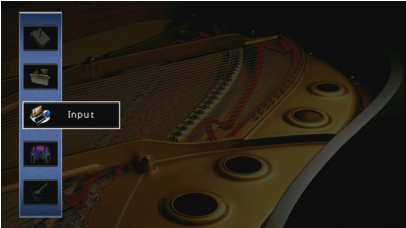

**3** Use the cursor keys (◀/▶) to select an input source to be configured and press the cursor key (▲).

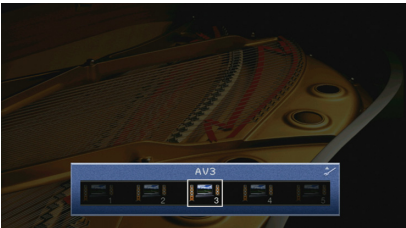

The input source of the unit also changes.



You can still switch the input source by using cursor keys (◀/▶) after Step 3.

**4** Use the cursor keys (▲/▼) to select an item and press ENTER.



To return to the previous screen during menu operations, press RETURN.

**5** Use the cursor keys to select a setting and press ENTER.

**6** To exit from the menu, press ON SCREEN.

# Input menu items



- Available items vary depending on the selected input source.
- Default settings are underlined.

Item	Function	Page
<b>Rename/Icon Select</b>	Changes the input source name and icon.	128
<b>Decoder Mode</b>	Sets the format of digital audio playback to DTS.	129
<b>Volume Interlock</b>	Enables/disables volume controls from iTunes/iPod via AirPlay.	129
<b>DMC Control</b>	Selects whether to allow a DLNA-compatible Digital Media Controller (DMC) to control playback. (RX-V3083 only)	129
<b>Balance Input Attenuator</b>	Selects whether to activate the attenuator for the balance input to avoid sound distortion.	129
<b>Ultra Low Jitter PLL Mode</b>	(RX-V3083 only) Enables/disables the jitter elimination function.	129

## Rename/Icon Select

Changes the input source name and icon displayed on the front display or TV screen.



Some network input sources (such as “AirPlay”) cannot be renamed or have the icons changed.

### Setup procedure

- 1 Use the cursor keys (◀/▶) to select “Auto” or “Manual” and press the cursor key (▼).

If you select “Auto”, the unit creates a name automatically according to the connected device. In this case, skip Steps 3 and 4.



This step is available only when “AV1-7”, “VIDEO AUX” or “AUDIO1-3” (available only when any audio digital input jack is assigned) is selected.

- 2 Use the cursor keys (◀/▶) to select an icon and press the cursor key (▼).
- 3 Press ENTER to enter the name edit screen.

- 4 Use the cursor keys and ENTER to rename and select “ENTER” to confirm the entry.

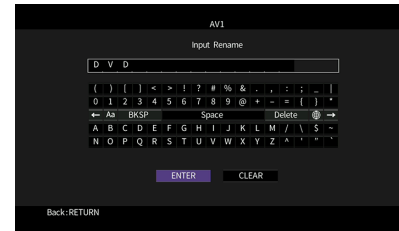

To clear the entry, select “CLEAR”.

- 5 Use the cursor keys to select “OK” and press ENTER.



To restore the default setting, select “RESET”.

- 6 To exit from the menu, press ON SCREEN.



## Decoder Mode

Sets the format of digital audio playback to “DTS”.

For example, if the unit does not detect DTS audio and outputs noise, set “Decoder Mode” to “DTS”.

### Input sources

AV 1-7, VIDEO AUX, AUDIO 1-4 (available only when any audio digital input jack is assigned)

\* **AUDIO 4: RX-V3083 only**

### Settings

<u>Auto</u>	Automatically selects an audio format to match the input audio signal.
DTS	Selects DTS only. (Other audio signals are not reproduced.)

## Volume Interlock

Enables/disables volume controls from iTunes/iPod via AirPlay.

### Input sources

AirPlay

### Settings

Off	Disables volume controls from iTunes/iPod.
<u>Limited</u>	Enables volume controls from iTunes/iPod within the limited range (-80 dB to -20 dB and mute).
Full	Enables volume controls from iTunes/iPod in the full range (-80 dB to +16.5 dB and mute).

## DMC Control

Selects whether to allow DLNA-compatible Digital Media Controller (DMC) to control playback.

### Input source

SERVER

### Settings

Disable	Does not allow DMCs to control playback.
<u>Enable</u>	Allows DMCs to control playback.



A Digital Media Controller (DMC) is a device that can control other network devices through the network. When this function is enabled, you can control playback of the unit from DMCs (such as Windows Media Player 12) on the same network.

## Balance Input Attenuator

(RX-V3083 only)

Selects whether to activate the attenuator for the balance input (AUDIO 4) so that you can avoid sound distortion when high-level signals are input.

Activate the attenuator when connecting an audio device which outputs signals of 3 V (RMS) or higher to the AUDIO 4 (XLR balanced input) jacks (p.46).

### Input source

AUDIO 4

### Settings

<u>Bypass</u>	Does not activate the attenuator for the balance input.
ATT.(-6dB)	Activates the attenuator for the balance input to reduce the signal level (-6dB).

## Ultra Low Jitter PLL Mode

(RX-V3083 only)

Enables/disables the jitter elimination function.

### Input source

AV 1-7, VIDEO AUX, AUDIO 1-4 (available only when any audio digital input jack is assigned), (network sources), Bluetooth, USB

### Settings

Off	Disables the jitter elimination function.
	Enables the jitter elimination function.
<u>Level 1</u> , Level 2, Level 3	The higher level enhances the DAC accuracy, but may cause audio interruptions on some playback devices depending on the audio clock conditions. In this case, select lower level.

## Configuring the SCENE function (Scene menu)

You can change the settings of the SCENE function (p.76) using the TV screen.

1 Press ON SCREEN.

2 Use the cursor keys to select “Scene” and press ENTER.

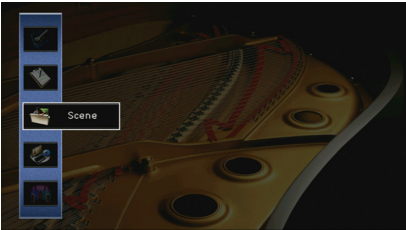

3 Use the cursor keys (◀/▶) to select a scene to be configured and press the cursor key (▲).

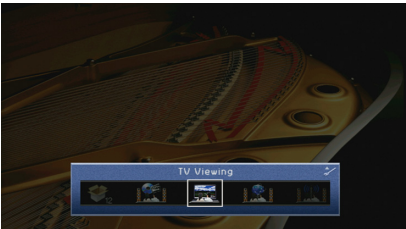

4 Use the cursor keys (▲/▼) to select an item and press ENTER.



5 Use the cursor keys and ENTER to change the setting.

6 To exit from the menu, press ON SCREEN.

## Scene menu items

Item	Function	Page
Save	Registers the current settings in the selected scene.	130
Load	Loads the settings registered for the selected scene. You can also configure the SCENE link playback setting, select items to be included as the scene assignments, or view the settings currently assigned to the selected scene.	131
Rename/Icon Select	Changes the scene name and icon.	132
Reset	Restores the default settings for the selected scene.	132

### Save

Registers the unit's current settings (such as input source and sound program) in the selected scene.



If you have changed the input assignment for a scene, you also need to change the external device assigned to the corresponding SCENE key (p.77).

## Load

Loads the settings registered for the selected scene.

Select “DETAIL” to configure the SCENE link playback setting or view the scene assignments.

## Device Control

Recalls a selected scene and starts its playback on an external device connected to the unit via HDMI. (SCENE link playback)

### Settings

Off	Disables the SCENE link playback function.
HDMI Control	Enables SCENE link playback using HDMI Control signals. Select this if an HDMI Control-compatible device (such as a BD/DVD player) is connected to the unit via HDMI. It also turns on the TV if it supports HDMI Control.

### Default

SCENE1-2: HDMI Control

SCENE3-12: Off



To control playback of an HDMI Control-compatible device by SCENE link playback, you need to set “HDMI Control” in the “Setup” menu to “On” and perform the HDMI Control link setup (p.188).

## Detail

Selects items to be included as the scene assignments. You can also view the settings currently assigned to the selected scene.

To include items as the scene assignments, use the cursor keys to select an item and press ENTER to check the box (or uncheck the box to exclude).

For example, if you often adjust the volume while watching TV but listen to radio with low volume at night, exclude “Volume” from the assignments for SCENE2 and include “Volume” in the assignments for SCENE4.



The scene assignments can include radio stations, or the content on a selected USB storage device and a network device.

### Check or uncheck



### Choices

Input	Input (p.75), Station <sup>*1</sup> , Listening <sup>*1</sup> , Music Content <sup>*2</sup> , Playback <sup>*2</sup> , Audio Select (p.126) <sup>*1</sup> Only when “TUNER” is selected <sup>*2</sup> Only when “Bluetooth”, “USB” or “NET” is selected
HDMI Output	HDMI Output (p.75)
Mode	DSP Program (p.78), Pure Direct Mode (p.146), Enhancer (p.83), Enhancer Hi-Res Mode (p.125)
Sound	Tone Control (p.123), YPAO Volume (p.123), Adaptive DRC (p.123), Extra Bass (p.124)
Surround	CINEMA DSP 3D Mode (p.146), Dialogue Lift (p.124), Dialogue Level (p.124), Subwoofer Trim (p.124)
Video	Video Mode (p.147), Video Adjustment (p.125)
Volume	Master Volume (p.75)
Lipsync	Lipsync (p.145), Delay (p.145)
Speaker Setup	Setting Pattern (p.140), PEQ Select (p.144)

### Default

Input, HDMI Output, Mode: selected

Sound, Surround, Video, Volume, Lipsync, Speaker Setup: not selected

Playing a radio station or content included as the scene assignments automatically when pressing **SCENE**



Individual contents cannot be registered for “Bluetooth” and “AirPlay”. The content lastly played back on each device will be recalled.

- 1 In the “Detail” screen, use the cursor keys (▲/▼) to select “Input” and press the cursor key (▶).
- 2 Use the cursor keys (▲/▼) to set “Listening” or “Playback” to “On”.  
When “TUNER” is selected, “Listening” is available.  
When “Bluetooth”, “USB” or “NET” is selected, “Playback” is available.
- 3 If “Input” is unchecked, press ENTER to check the box.
- 4 To exit from the menu, press ON SCREEN.

## ■ Rename/Icon Select

Changes the scene name and icon displayed on the front display or TV screen.

### ■ Setup procedure

- 1 Use the cursor keys (◀/▶) to select an icon and press the cursor key (▼).



- 2 Press ENTER to enter the name edit screen.
- 3 Use the cursor keys and ENTER to rename and select “ENTER” to confirm the entry.

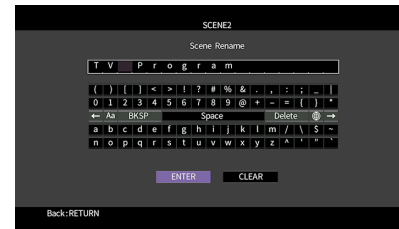

To clear the entry, select “CLEAR”.

- 4 Use the cursor keys to select “OK” and press ENTER.



To restore the default setting, select “RESET”.

- 5 To exit from the menu, press ON SCREEN.

## ■ Reset

Restores the default settings (p.76) for the selected scene.

## Configuring sound programs/surround decoders (DSP Program menu)

You can change the settings of the sound programs and surround decoders using the TV screen.

- 1 Press ON SCREEN.
- 2 Use the cursor keys to select “DSP Program” and press ENTER.

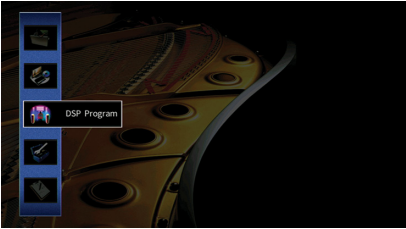

- 3 Use the cursor keys (◀/▶) to select a sound program to be configured and press the cursor key (▲).

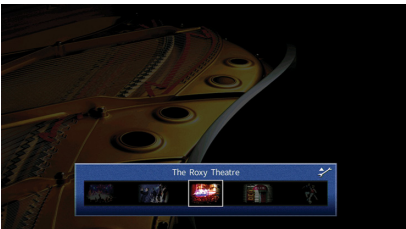

You can still switch the sound program by using cursor keys (◀/▶) after Step 3.

- 4 Use the cursor keys (▲/▼) to select an item and press ENTER.



- To return to the previous screen during menu operations, press RETURN.
- To restore the default settings for the selected sound program, select “Reset”.

- 5 Use the cursor keys to select a setting and press ENTER.
- 6 To exit from the menu, press ON SCREEN.

## DSP Program menu items



- Available items and the default settings vary depending on the selected sound program or surround decoder.
- Default settings are underlined.

### Settings for sound programs

Item	Function	Settings
<b>Decode Type</b>	Selects a surround decoder to be used in combination with the selected sound program.	<u>Auto</u> ,  Dsur*, Neural:X, Neo:6 Cinema, Neo:6 Music* (* Available only when "SURROUND DECODER" is selected)
<b>DSP Level</b>	Adjusts the sound field effect level.	-6 dB to <u>0</u> dB to +3 dB Higher to enhance the sound field effect, and lower to reduce it.
<b>Initial Delay</b>	Adjusts the delay between the direct sound and presence sound field generation.	1 ms to 99 ms Higher to enhance the delay effect, and lower to reduce it.
<b>Surround Initial Delay</b>	Adjusts the delay between the direct sound and surround sound field generation.	1 ms to 49 ms Higher to enhance the delay effect, and lower to reduce it.
<b>Surround Back Initial Delay</b>	Adjusts the delay between the direct sound and surround back sound field generation.	Higher to enhance the delay effect, and lower to reduce it.
<b>Room Size</b>	Adjusts the broadening effect of the presence sound field.	0.1 to 2.0
<b>Surround Room Size</b>	Adjusts the broadening effect of the surround sound field.	Higher to enhance the broadening effect, and lower to reduce it.
<b>Surround Back Room Size</b>	Adjusts the broadening effect of the surround back sound field.	Higher to enhance the broadening effect, and lower to reduce it.
<b>Liveness</b>	Adjusts the loss of the presence sound field.	0 to 10
<b>Surround Liveness</b>	Adjusts the loss of the surround sound field.	Higher to enhance the reflectivity, and lower to reduce it.
<b>Surround Back Liveness</b>	Adjusts the loss of the surround back sound field.	Higher to enhance the reflectivity, and lower to reduce it.

Item	Function	Settings
<b>Reverb Time</b>	Adjust the decay time of the rear reverberant sound.	1.0 s to 5.0 s Higher to enrich the reverberant sound and lower to have clear sound.
<b>Reverb Delay</b>	Adjusts the delay between the direct sound and reverberant sound generation.	0 ms to 250 ms Higher to enhance the delay effect, and lower to reduce it.
<b>Reverb Level</b>	Adjusts the volume of the reverberant sound.	0% to 100% Higher to strengthen the reverberant sound, and lower to weaken it.

The following items are available when you select "9ch Stereo".

Item	Function	Settings
<b>Level</b>	Adjusts the entire volume.	-5 to <u>0</u> to +5
<b>Front / Rear Balance</b>	Adjusts the front and rear volume balance.	-5 to <u>0</u> to +5 Higher to enhance the front side, and lower to enhance the rear side.
<b>Left / Right Balance</b>	Adjusts the left and right volume balance.	-5 to <u>0</u> to +5 Higher to enhance the right side, and lower to enhance the left side.
<b>Height Balance</b>	Adjust the height volume balance using the presence speakers.	0 to <u>5</u> to 10 Higher to enhance the upside, and lower to enhance the downside. (The presence speakers do not produce sounds when "Height Balance" is set to "0".)
<b>Monaural Mix</b>	Enables/disables monaural sound output.	<u>Off</u> , On



Available items in "9ch Stereo" vary depending on the speaker system being used.

## ■ Settings for decoders

The following items are available when you set “Decode Type” of “SURROUND DECODER” to “Dsur” or “Neo:6 Music”.

Decode Type	Item	Function	Settings
<input checked="" type="checkbox"/> Dsur	Center Spread	Selects whether to spread the center channel signals to left and right when 2-channel source is played.	<u>Off</u> , On Select “On” to spread center channel signals to left and right if you feel the center sound is too strong when 2-channel source is played.
Neo:6 Music	Center Image	Adjusts the center orientation level (broadening effect) of the front sound field.	0.0 to <u>0.3</u> to 1.0 Higher to strengthen the center orientation level (less broadening effect) and lower to weaken (more broadening effect).

## Configuring various functions (Setup menu)

You can configure the unit's various function with the menu displayed on the TV screen.

**1** Press ON SCREEN.

**2** Use the cursor keys to select "Setup" and press ENTER.

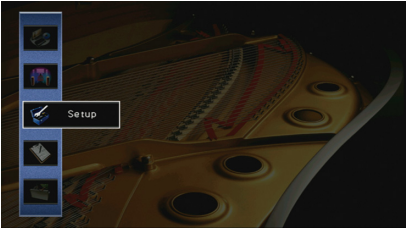

**3** Use the cursor keys (◀/▶) to select a menu.



**4** Use the cursor keys (▲/▼) to select an item and press ENTER.



To return to the previous screen during menu operations, press RETURN.

**5** Use the cursor keys to select a setting and press ENTER.

**6** To exit from the menu, press ON SCREEN.



## Setup menu items

Menu	Item	Function	Page	
Speaker	<b>Auto Setup</b>	Automatically optimizes the speaker settings (YPAO).	54	
	<b>Setting Pattern</b>	Registers two speaker setting patterns and switches between them.	140	
	<b>Setting Data Copy</b>	Copies the "Setting Pattern" parameters in the specified direction.	140	
	<b>Power Amp Assign</b>	Selects a speaker system.	140	
	<b>Front</b>	Selects the size of the front speakers.	141	
	<b>Center</b>	Selects whether or not a center speaker is connected and its size.	141	
	<b>Surround</b>	Selects whether or not surround speakers are connected and their size.	141	
	<b>Surround Back</b>	Selects whether or not surround back speakers are connected and their size.	142	
	<b>Configuration</b>	<b>Front Presence</b>	Selects whether or not front presence speakers are connected and their size.	142
	<b>Rear Presence</b>	Selects whether or not rear presence speakers are connected and their size.	142	
	<b>Subwoofer 1</b>	Selects whether or not a subwoofer is connected to the SUBWOOFER 1 or SUBWOOFER 2 jack and its phase.	142	
	<b>Subwoofer 2</b>			
	<b>Layout</b>	Selects the layouts of the surround speakers, front/rear presence speakers and subwoofers.	143	
	<b>Distance</b>	Sets the distance between each speaker and listening position.	143	
	<b>Level</b>	Adjusts the volume of each speaker.	144	
	<b>Parametric EQ</b>	Adjusts the tone with an equalizer.	144	
	<b>Test Tone</b>	Enables/disables the test tone output.	144	

Menu	Item	Function	Page	
Sound	<b>Delay Enable</b>	Enables/disables the Lipsync adjustment for each input source.	145	
	<b>Lipsync</b>	<b>Auto/Manual Select</b>	Selects the method to adjust the delay between video and audio output.	145
		<b>Adjustment</b>	Adjusts the delay between video and audio output manually.	145
	<b>Dynamic Range</b>	Selects the dynamic range adjustment method for bitstream audio (Dolby Digital and DTS signals) playback.	145	
	<b>Max Volume</b>	Sets the limit value of the volumes.	146	
	<b>Initial Volume</b>	Sets the initial volume for when this receiver is turned on.	146	
	<b>Pure Direct Mode</b>	Selects whether to output video signals during the Pure Direct mode.	146	
	<b>Adaptive DSP Level</b>	Selects whether to automatically adjust the CINEMA DSP effect level.	146	
	<b>CINEMA DSP 3D Mode</b>	Enables/disables CINEMA DSP HD <sup>3</sup> .	146	
	<b>Virtual Presence Speaker</b>	Selects whether to create Virtual Presence Speaker (VPS) using the front, center, and surround speakers.	146	
	<b>Virtual Surround Back Speaker</b>	Selects whether to create Virtual Surround Back Speaker (VSBS) using the surround speakers.	146	
	<b>DAC Digital Filter (RX-V3083 only)</b>	Selects the digital filter type of the audio DAC (digital-to-analog converter).	147	
	<b>Object Decode Mode</b>	Enables/disables playback of object-based audio signals such as Dolby Atmos or DTS:X contents.	147	
<b>Video</b>	<b>Video Mode</b>	Enables/disables the video signal processing (resolution, aspect ratio and video adjustments).	147	
HDMI	<b>HDMI Control</b>	Enables/disables HDMI Control. You can also configure the relevant settings (such as ARC and TV audio input).	149	
	<b>Audio Output</b>	Selects a device to output audio.	150	
	<b>Standby Through</b>	Select whether to output videos/audio (input through HDMI jacks) to the TV when the unit is in standby mode.	150	
Network	<b>Network Connection</b>	Selects the network connection method.	150	
	<b>IP Address</b>	Configures the network parameters (such as IP address).	150	
	<b>Network Standby</b>	Selects whether to enable/disable the function that turns on the unit from other network devices.	151	
	<b>MAC Address Filter</b>	Sets the MAC address filter to limit access to the unit from other network devices.	151	
	<b>Network Name</b>	Edits the network name (the unit's name on the network) displayed on other network devices.	152	
	<b>MusicCast Link Power Interlock</b>	Selects whether turning on the power of the master device of the MusicCast network (the unit) also turns on the power of other devices of the network.	152	
Bluetooth	<b>Bluetooth</b>	Enables/disables the Bluetooth functions.	152	
	<b>Audio Receive</b>	<b>Disconnect</b>	Terminates the Bluetooth connection between the Bluetooth device (such as smartphones) and the unit.	95
		<b>Bluetooth Standby</b>	Selects whether to enable/disable the function that turns on the unit from Bluetooth devices (Bluetooth standby).	152
	<b>Audio Send</b>	<b>Transmitter</b>	Enables/disables the Bluetooth audio transmitter function.	153
		<b>Device Search</b>	Searches available Bluetooth devices (speakers/headphones) when the unit is used as a Bluetooth audio transmitter.	96

Menu	Item	Function	Page	
Multi Zone	Main Zone Set	Zone Rename	Changes the zone name (for main zone) displayed on the front display or TV screen.	153
		Volume	Enables/disables volume adjustments for Zone2 or Zone3 output.	154
		Max Volume	Sets the Zone2 or Zone3 limit value of the volume.	154
		Initial Volume	Sets the Zone2 or Zone3 initial volume for when the unit is turned on.	154
		Audio Delay	Adjusts the audio output timing for Zone2 or Zone3.	154
	Zone2 Set	Mono	Switches between stereo and monaural for Zone2 or Zone3 output.	154
	Zone3 Set	Enhancer	Enables/disables Compressed Music Enhancer for Zone2 or Zone3 output.	154
		Tone Control	Adjusts the level of high-frequency range and low-frequency range for Zone2 or Zone3 output.	154
		Extra Bass	Enables/disables Extra Bass for Zone2 or Zone3 output.	155
		Balance	Adjusts the front speaker balance for Zone2 or Zone3 output.	155
		Zone Rename	Changes the zone name (for Zone2 or Zone3) displayed on the front display or TV screen.	155
	Zone4 Set	Zone Rename	Changes the zone name (for Zone4) displayed on the front display or TV screen.	155
		HDMI OUT2 Assign	Select the zone for which the HDMI OUT 2 (ZONE OUT) jack is used.	155
		Party Mode Set	Enables/disables switching to the party mode for each zone.	155
Function		Input Assignment	Assigns the COMPONENT VIDEO, COAXIAL and OPTICAL jacks to another input source.	156
		Remote PROGRAM Key	Assigns the desired function to the PROGRAM keys of the remote control.	156
	Display Set	Dimmer (Front Display)	Adjusts the brightness of the front display.	156
		Short Message	Selects whether to display short messages on the TV screen when the unit is operated.	156
		Wallpaper	Selects the image to be used as wallpaper on the TV.	157
	Trigger Output1	Trigger Mode	Specifies the condition for the TRIGGER OUT jack to function.	157
	Trigger Output2	Target Zone	Specifies the zone with which the TRIGGER OUT jack functions are synchronized.	157
		Memory Guard	Prevents accidental changes to the settings.	158
ECO	Auto Power Standby	Sets the amount of time for the auto-standby function.	158	
	ECO Mode	Enables/disables the eco mode (power saving mode).	159	
Language		Select an on-screen menu language.	159	

## Speaker (Manual Setup)

Configures the speaker settings manually.



Default settings are underlined.

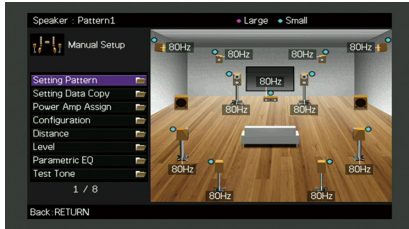

## Setting Pattern

Registers two speaker setting patterns and switches between them.

When you configure the following speaker settings, the settings will be memorized in the selected pattern.

- Measurement results (Auto Setup)
- Power Amp Assign
- Configuration
- Distance
- Level
- Parametric EQ

### Settings

Pattern1, Pattern2



- The setting pattern currently selected is shown at the top of the “Manual Setup” screen.
- This function is useful when you want to save certain settings according to the varying conditions of your listening environment. For example, if you want to switch the settings when curtains are open or closed, you can save the settings suited for each condition and switch between them.

## Setting Data Copy

Copies the “Setting Pattern” parameters in the specified direction.

### Choices

Pattern1 ▶ 2	Copies the “Pattern1” parameters to “Pattern2”.
Pattern2 ▶ 1	Copies the “Pattern2” parameters to “Pattern1”.

## Power Amp Assign

Selects a speaker system.

The unit has 9 built-in amplifiers. You can connect 2 to 11 speakers and up to 2 subwoofers (with built-in amplifier) to create the favorite acoustic space in your room. You can also apply bi-amp connections, channel expansion (using an external power amplifier) or multi-zone configurations to enhance your system.

### Settings

<u>Basic</u>	Select this option when you use the basic speaker configuration (up to 9-channel plus rear presence speakers) (p.21).
7.2 +1Zone	Select this option when you use Zone2 (or Zone3) speakers in addition to the 7.2 system in the main zone (p.32). You can select a zone to be assigned to the EXTRA SP 1 jacks (default: Zone2).
7.2.2 +1Zone	Select this option when you use Zone2 (or Zone3) speakers in addition to the 7.2.2 system in the main zone (p.32). You can select a zone to be assigned to the EXTRA SP 2 jacks (default: Zone2).
7.2 +2Zone	Select this option when you use Zone2 and Zone3 speakers in addition to the 7.2 system in the main zone (p.32). You can select a zone to be assigned to the EXTRA SP 1 and EXTRA SP 2 jacks (default: Zone2 for EXTRA SP 1, Zone3 for EXTRA SP 2).
7.2.4 [ext.RP]	(RX-V3083 only) Select this option when you use the 7.2.4 system including rear presence channel expansion using an external amplifier (p.33).
7.2.4 [ext.Front]	(RX-V3083 only) Select this option when you use the 7.2.4 system including front channel expansion using an external amplifier (p.34).
7.2.4 [ext.FP+RP]	(RX-V3083 only) Select this option when you use the 7.2.4 system including front presence and rear presence channel expansion using an external amplifier (p.34).
7.2.2 [ext.Front] +1Zone	Select this option when you use Zone2 (or Zone3) speakers in addition to the 7.2.2 system (including front channel expansion using an external amplifier) in the main zone (p.35). You can select a zone to be assigned to the EXTRA SP 2 jacks (default: Zone2).

7.2 [ext.Front] +2Zone	Select this option when you use Zone2 and Zone3 speakers in addition to the 7.2 system (including front channel expansion using an external amplifier) in the main zone (p.35). You can select a zone to be assigned to the EXTRA SP 1 and EXTRA SP 2 jacks (default: Zone2 for EXTRA SP 1, Zone3 for EXTRA SP 2).
7.2 Bi-Amp	Select this option when you use the 7.2 system including bi-amp front speakers (p.36).
5.2.2 Bi-Amp	Select this option when you use the 5.2.2 system including bi-amp front speakers (p.36).
7.2 Bi-Amp +1Zone	Select this option when you use Zone2 (or Zone3) speakers in addition to the 7.2 system (including bi-amp front speakers) in the main zone (p.37). You can select a zone to be assigned to the EXTRA SP 2 jacks (default: Zone2). (RX-V3083 only)
7.2.4 Bi-Amp [ext.FP+RP]	Select this option when you use the 7.2.4 system including bi-amp front speakers, and front presence and rear presence channel expansion using an external amplifier) (p.37). (RX-V3083 only)
5.2.4 Bi-Amp [ext.RP]	Select this option when you use the 5.2.4 system including bi-amp front speakers and rear presence channel expansion using an external amplifier) (p.38).

## Configuration

Configures the output characteristics of the speakers.



- When you configure the speaker size, select “Large” if the woofer diameter of your speaker is 16 cm (6-1/4”) or larger or “Small” if it is smaller than 16 cm (6-1/4”) as a guide.
- When the speaker size is set to “Small”, you can configure the “Crossover” setting after pressing ENTER. Frequency sounds lower than the specified value will be output from the subwoofer and higher will be output from the corresponding speakers.

## Front

Selects the size of the front speakers.

### Settings

Large	Select this option for large speakers. The front speakers will produce all of the front channel frequency components.
<u>Small</u>	Select this option for small speakers. The subwoofer will produce front channel low-frequency components lower than the specified crossover frequency (default: 80 Hz).



“Front” is automatically set to “Large” when both “Subwoofer 1” and “Subwoofer 2” are set to “None”.

## Center

Selects whether or not a center speaker is connected and its size.

### Settings

Large	Select this option for large speakers. The center speaker will produce all of the center channel frequency components.
<u>Small</u>	Select this option for small speakers. The subwoofer or front speakers will produce center channel low-frequency components lower than the specified crossover frequency (default: 80 Hz).
None	Select this option when no center speaker is connected. The front speakers will produce center channel audio.

## Surround

Selects whether or not surround speakers are connected and their sizes.

### Settings

Large	Select this option for large speakers. The surround speakers will produce all of the surround channel frequency components.
<u>Small</u>	Select this option for small speakers. The subwoofer or front speakers will produce surround channel low-frequency components lower than the specified crossover frequency (default: 80 Hz).
None	Select this option when no surround speakers are connected. The front speakers will produce surround channel audio. Virtual CINEMA DSP works when you select a sound program.

## Surround Back

Selects whether or not surround back speakers are connected and their sizes.

### Settings

Large x1	Select this option when one large speaker is connected. The surround back speaker will produce all of the surround back channel frequency components.
Large x2	Select this option when two large speakers are connected. The surround back speakers will produce all of the surround back channel frequency components.
Small x1	Select this option when one small speaker is connected. The subwoofer or front speakers will produce surround back channel low-frequency components lower than the specified crossover frequency (default: 80 Hz).
Small x2	Select this option when two small speakers are connected. The subwoofer or front speakers will produce surround back channel low-frequency components lower than the specified crossover frequency (default: 80 Hz).
None	Select this option when no surround back speakers are connected. The surround speakers will produce surround back channel audio.



This setting is not available when “Surround” is set to “None”, or when “Layout (Surround)” is set to “Front”.

## Front Presence

Selects whether or not front presence speakers are connected and their size.

### Settings

Large	Select this option for large speakers.
Small	Select this option for small speakers.
None	Select this option when no front presence speakers are connected.

## Rear Presence

Selects whether or not rear presence speakers are connected and their size.

### Settings

Large	Select this option for large speakers.
Small	Select this option for small speakers.
None	Select this option when no rear presence speakers are connected.



This setting is not available when “Surround” or “Front Presence” is set to “None”.

## Subwoofer 1, Subwoofer 2

Selects whether or not a subwoofer is connected to the SUBWOOFER 1 or SUBWOOFER 2 jack and its phase.

### Settings

Use	Normal	Select this option when a subwoofer is connected to the SUBWOOFER 1 or SUBWOOFER 2 jack (phase not reversed). The subwoofer will produce LFE (low-frequency effect) channel audio and low-frequency components from other channels.
	Reverse	Select this option when a subwoofer is connected to the SUBWOOFER 1 or SUBWOOFER 2 jack (phase reversed). The subwoofer will produce LFE (low-frequency effect) channel audio and low-frequency components from other channels.
None		Select this option when no subwoofer is connected to the SUBWOOFER 1 or SUBWOOFER 2 jack. The front speakers will produce LFE (low-frequency effect) channel audio and low-frequency components from other channels when both “Subwoofer 1” and “Subwoofer 2” are set to “None”.



When the bass sound is lacking or unclear, switch the subwoofer phase.

## Layout

Selects the layouts of the surround speakers, front/rear presence speakers and subwoofers.

### Surround

Selects a surround speaker layout when surround speakers are used.

#### Settings

<u>Rear</u>	Select this option when surround speakers are placed on the rear side of the room.
Front	Select this option when surround speakers are placed on the front side of the room. Virtual CINEMA FRONT (p.81) works in this case.



This setting is not available when “Configuration (Surround)” is set to “None”.

### Front Presence

Selects a front presence layout when front presence speakers are used. This setting facilitates the optimization of the sound field effect.

#### Settings

<u>Front Height</u>	Select this option when front presence speakers are installed on the front side wall.
Overhead	Select this option when front presence speakers are installed to the ceiling.
Dolby Enabled SP	Select this option when using the Dolby Enabled speakers as the front presence speakers.



• This setting is not available when “Configuration (Front Presence)” is set to “None”.

• To play Dolby Atmos contents using the presence speakers, see “Presence speaker layout” (p.26).

### Rear Presence

Selects a rear presence layout when rear presence speakers are used. This setting facilitates the optimization of the sound field effect.

#### Settings

<u>Rear Height</u>	Select this option when rear presence speakers are installed on the rear side wall.
Overhead	Select this option when rear presence speakers are installed to the ceiling.
Dolby Enabled SP	Select this option when using the Dolby Enabled speakers as the rear presence speakers.



- This setting is not available when “Configuration (Surround/Front Presence/Rear Presence)” is set to “None”.
- To play Dolby Atmos contents using the presence speakers, see “Presence speaker layout” (p.26).

### Subwoofer

Selects a subwoofer layout when 2 subwoofers are used.

#### Settings

Left + Right	Select this option when 2 subwoofers are placed on the left and right sides of the room.
Front + Rear	Select this option when 2 subwoofers are placed on the front and rear sides of the room.
<u>Monaural x2</u>	Select this option when 2 subwoofers are placed freely.



This setting is not available when “Subwoofer 1” or “Subwoofer 2” is set to “None”.

## Distance

Sets the distance between each speaker and listening position so that sounds from the speakers reach the listening position at the same time. First, select the unit of distance from “Meter” or “Feet”.

#### Choices

Front L, Front R, Center, Surround L, Surround R, Surround Back L, Surround Back R, Front Presence L, Front Presence R, Rear Presence L, Rear Presence R, Subwoofer 1, Subwoofer 2

#### Setting range

0.30 m to 3.00 m to 24.00 m (1.0 ft to 10.0 ft to 80.0 ft), 0.05 m (0.2 ft) increments

## Level

Adjusts the volume of each speaker.

### Choices

Front L, Front R, Center, Surround L, Surround R, Surround Back L, Surround Back R, Front Presence L, Front Presence R, Rear Presence L, Rear Presence R, Subwoofer 1, Subwoofer 2

### Setting range

-10.0 dB to 0.0 dB to +10.0 dB (0.5 dB increments)

## Parametric EQ

Adjusts the tone with an equalizer.

### Settings

Manual	Select this option when you want to adjust the equalizer manually. For details, see “Manual equalizer adjustment”.
YPAO:Flat	Adjusts individual speakers to achieve the same characteristics.
YPAO:Front	Adjusts individual speakers to achieve the same characteristics as the front speakers.
YPAO:Natural	Adjusts all speakers to achieve a natural sound.
Through	Does not use the equalizer.



“YPAO:Flat”, “YPAO:Front”, and “YPAO:Natural” are available only when the measurement results of “Auto Setup” have already been saved (p.54). Press ENTER again to view the measurement results.

### Manual equalizer adjustment

- 1 Set “Parametric EQ” to “Manual” and press ENTER.
- 2 Press ENTER again to enter the edit screen.
- 3 Use the cursor keys to select a speaker and press ENTER.



- To restore the default settings for all speakers, select “PEQ Data Clear” and then “OK”.
- To copy the parametric equalizer values acquired with “Auto Setup” (p.54) to the “Manual” fields for fine adjustment, select “PEQ Data Copy” and then an equalizer type.

- 4 Use the cursor keys (◀/▶) to select a center frequency from the 7 preset bands (4 for subwoofer) and the cursor keys (▲/▼) to adjust the gain.

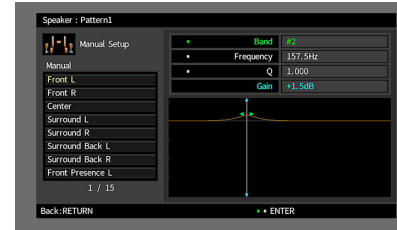

### Setting range

Gain: -20.0 dB to +6.0 dB

- 5 To fine-adjust the center frequency or Q factor (bandwidth), press ENTER repeatedly to select an item.

**Frequency:** Use the cursor keys (◀/▶) to adjust the center frequency of the selected band and the cursor keys (▲/▼) to adjust the gain.

**Q:** Use the cursor keys (◀/▶) to adjust the Q factor (bandwidth) of the selected band and the cursor keys (▲/▼) to adjust the gain.

### Setting range

Center frequency: 15.6 Hz to 16.0 kHz (15.6 Hz to 250.0 Hz for subwoofer)

Q factor: 0.500 to 10.080

- 6 To exit from the menu, press ON SCREEN.

## Test Tone

Enables/disables the test tone output. Test tone output helps you to adjust the speaker balance or equalizer while confirming its effect.

### Settings

Off	Does not output test tones.
On	Outputs test tones automatically when you adjust the speaker balance or equalizer.



## Sound

Configures the audio output settings.



### Lipsync

Adjusts the delay between video and audio by holding up the audio output.

#### Delay Enable

Enables/disables the Lipsync adjustment for each input source.

##### Choices

AV 1-7, VIDEO AUX, AUDIO 1-4\*

\* AUDIO 4: RX-V3083 only

##### Settings

<u>Disable</u>	Disable the Lipsync adjustment for the selected input source.
<u>Enable</u>	Enables the Lipsync adjustment for the selected input source.

#### Auto/Manual Select

Selects the method to adjust the delay between video and audio output.

##### Setting range

<u>Auto</u>	Adjusts the delay between video and audio output automatically when a TV that supports an automatic lipsync function is connected to the unit via HDMI. If necessary, you can fine-adjust the audio output timing in “Adjustment”.
Manual	Select this option when you want to adjust the delay between video and audio output manually. Adjust the audio output timing in “Adjustment”.



Even if “Auto/Manual Select” is set to “Auto”, the automatic adjustment does not work depending on the TV connected to the unit. In this case, adjust the delay manually in “Adjustment”.

## Adjustment

Adjusts the delay between video and audio output manually when “Auto/Manual Select” is set to “Manual”. You can fine-adjust the audio output timing when “Auto/Manual Select” is set to “Auto”.



##### Setting range

0 ms to 500 ms (1 ms increments)



- When “Auto/Manual Select” is set to “Auto”, “Offset” shows the difference between automatic adjustment and fine adjustment.
- This setting is also available in “Lipsync Adjustment” (p.124) in the “Option” menu.

### Dynamic Range

Selects the dynamic range adjustment method for bitstream audio (Dolby Digital and DTS signals) playback.

##### Settings

<u>Maximum</u>	Produces audio without adjusting the dynamic range.
Standard	Optimizes the dynamic range for regular home use.
Minimum/Auto	Sets the dynamic range for clear sound even at night or at low volumes. When playing back Dolby TrueHD signals, the dynamic range is automatically adjusted based on the input signal information.

## ■ Max Volume

Sets the limit value of the volume.

### Setting range

-30.0 dB to +15.0 dB (5.0 dB increments), +16.5 dB

## ■ Initial Volume

Sets the initial volume when the receiver is turned on.

### Settings

<u>Off</u>	Sets the level to the volume level of the unit when it last entered standby mode.
On	Sets at Mute or the specified volume level (-80.0 dB to +16.5 dB, 0.5 dB increments). (Specify a volume level which is lower than the “Max Volume” setting.)

## ■ Pure Direct Mode

Selects whether to output video signals during the Pure Direct mode (p.83).

### Settings

<u>Auto</u>	Automatically outputs video signals when any videos are input from the selected input source or an input source that can be operated with the on-screen display is selected. When no video signals are input, the wall paper is displayed.
Video Off	Does not output video signals including the wall paper.

## ■ Adaptive DSP Level

Selects whether to automatically adjust the CINEMA DSP effect level.

### Settings

Off	Does not adjust the effect level automatically.
<u>On</u>	Adjusts the effect level automatically according to the YPAO measurement results and the volume level.

## ■ CINEMA DSP 3D Mode

Enables/disables CINEMA DSP HD<sup>3</sup> (p.79). If this function is set to “On”, CINEMA DSP HD<sup>3</sup> functions with the selected sound programs (except 2ch Stereo and 9ch Stereo).

### Settings

Off	Disables CINEMA DSP HD <sup>3</sup> .
<u>On</u>	Enables CINEMA DSP HD <sup>3</sup> .

## ■ Virtual Presence Speaker

Selects whether to create Virtual Presence Speaker (VPS) using the front, center, and surround speakers. When VPS is enabled, the unit creates front VPS when no front presence speakers are connected, and creates rear VPS when front presence speakers are connected but no rear presence speakers (p.79).

### Settings

Off	Disables Virtual Presence Speaker (VPS).
<u>On</u>	Enables Virtual Presence Speaker (VPS).



Depending on the installation height of the surround speakers, VPS may not be effective. In this case, set “Virtual Presence Speaker” to “Off”.

## ■ Virtual Surround Back Speaker

Selects whether to create Virtual Surround Back Speaker (VSBS) using the surround speakers. When VSBS is enabled, the unit creates VSBS when no surround back speakers are connected.

### Settings

Off	Disables Virtual Surround Back Speaker (VSBS).
<u>On</u>	Enables Virtual Surround Back Speaker (VSBS).



VSBS is effective only when 6.1- or 7.1-channel content is played back.

## DAC Digital Filter

(RX-V3083 only)

Selects the digital filter type of the audio DAC (digital-to-analog converter) to have favorite sounds.

### Settings

Sharp Roll-off Type	Removes out-of-band noises by the filter with steep attenuation characteristics. It has a tendency to produce clear sounds.
Slow Roll-off Type	Removes out-of-band noises by the filter with gentle attenuation characteristics. It has a tendency to produce soft sounds.
<u>Short Latency Type</u>	Reduces the audio delay caused by the DAC internal digital filter. It has a tendency to produce responsive and rhythmical sounds.

## Object Decode Mode

Enables/disables playback of object-based audio signals such as Dolby Atmos or DTS:X contents.

### Settings

Disable	Disables playback of object-based audio signals. Those signals will be played in normal 5.1-/7.1-channel audio.
<u>Enable</u>	Enables playback of object-based audio signals.



If audio output is not available when Dolby Atmos or DTS:X signals are input, set “Object Decode Mode” to “Enable”.

## Video

Configures the video output settings.

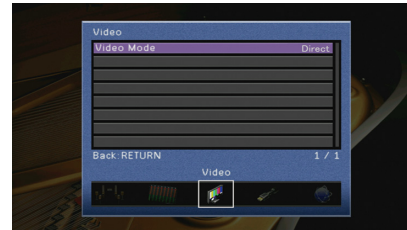

## Video Mode

Enables/disables the video signal processing (resolution, aspect ratio and video adjustments).

### Settings

<u>Direct</u>	Disables the video signal processing.
Processing	Enables the video signal processing. Configure the settings in “Resolution”, “Aspect” and “Adjustment”.



When “Video Mode” is set to “Direct”, the unit transmits video signals with the least circuitry in order to reduce video output delay.

## Resolution

Selects a resolution to output HDMI video signals when “Video Mode” is set to “Processing”.

### Settings

Through	Does not convert the resolution.
<u>Auto</u>	Selects a resolution automatically in accordance with TV resolution.
480p/576p, 720p, 1080i, 1080p, 4K	Output video signals with a selected resolution. (Only the resolutions supported by your TV are selectable.)



If you need to select a resolution that is not supported by your TV, set “MONITOR CHECK” (p.163) in the “ADVANCED SETUP” menu to “SKIP” and try again. (Note that the output video may not be displayed on your TV normally.)

## Aspect

Selects an aspect ratio to output HDMI video signals when “Video Mode” is set to “Processing”.

### Settings

Through	Does not convert the aspect ratio.
16:9 Normal	Outputs 4:3 video signals to a 16:9 TV with black bands on either side of the screen.



This setting functions only when 480i/576i or 480p/576p signals are converted into 720p, 1080i, 1080p, or 2160p (4K) signals.

## Adjustment

Configures the video adjustments when “Video Mode” is set to “Processing”. You can register the video adjustments as presets (up to 6).



The video adjustments work on the video signals with 1080p or lower resolution.

### Setup procedure

- 1 Use the cursor keys (▲/▼) to select a preset number and press ENTER.
- 2 Use the cursor keys (▲/▼) to select an item.

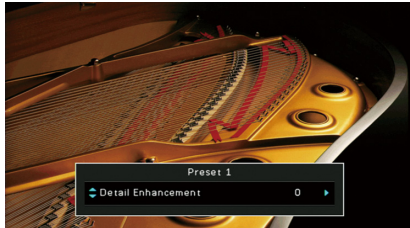

- 3 Use the cursor keys (◀/▶) to select a setting and press ENTER.
- 4 To exit from the menu, press ON SCREEN.

## Detail Enhancement

Adjusts the enhancement effect of video details.

### Setting range

0 to 50

## Edge Enhancement

Adjusts the enhancement effect of video edges.

### Setting range

0 to 50

## Brightness

Adjusts the video brightness.

### Setting range

-100 to 0 to +100

## Contrast

Adjusts the video contrast.

### Setting range

-100 to 0 to +100

## Saturation

Adjusts the video saturation.

### Setting range

-100 to 0 to +100

## HDMI

Configures the HDMI settings.



### HDMI Control

Enables/disables HDMI Control (p.188).

#### Settings

<u>Off</u>	Disables HDMI Control.
On	Enables HDMI Control. Configure the settings in “TV Audio Input”, “ARC” and “Standby Sync”.



To use HDMI control, you need to perform the HDMI Control link setup (p.188) after connecting HDMI Control-compatible devices.

### TV Audio Input

Selects an audio input jack of the unit to be used for TV audio input when “HDMI Control” is set to “On”. The unit’s input source automatically switches to TV audio when the TV input is switched to its built-in tuner.

#### Settings

AUDIO 1-3

#### Default

AUDIO 1



When using ARC to input TV audio to the unit, you cannot use the input jacks selected here for connecting an external device because the input will be used for TV audio input.

## ARC

Enables/disables ARC (p.190) when “HDMI Control” is set to “On”.

#### Settings

<u>Off</u>	Disables ARC.
On	Enables ARC.



You do not need to change this setting normally. In case noises are produced from the speakers connected to the unit because TV audio signals input to the unit via ARC are not supported by the unit, set “ARC” to “Off” and use the TV’s speakers.

### Standby Sync

Select whether to use HDMI control to link the standby behavior of the TV and the unit when “HDMI Control” is set to “On”.

#### Settings

<u>Off</u>	Does not set the unit to standby mode when the TV is turned off.
On	Sets the unit to standby mode when the TV is turned off.
Auto	Sets the unit to standby mode when the TV is turned off only when the unit is receiving TV audio or HDMI signals.

## Audio Output

Selects a device to output audio.



- The “HDMI OUT1” setting is available only when “HDMI Control” is set to “Off”.
- The “HDMI OUT2” setting is available only when “HDMI OUT2 Assign” (p.155) is set to “Main”.

### HDMI OUT1, HDMI OUT2

Enables/disables the audio output from a TV connected to the HDMI OUT 1 jack or HDMI OUT 2 jack.

#### Settings

<u>Off</u>	Disables the audio output from the TV.
On	Enables the audio output from the TV.



The HDMI OUT 1-2 jacks output 2-channel audio signals when the unit is turned on.

## Standby Through

Select whether to output videos/audio (input through HDMI jacks) to the TV when the unit is in standby mode. If this function is set to “On” or “Auto”, you can use the input selection keys (AV 1-7 and V-AUX) to select an HDMI input even when the unit is in standby mode (the standby indicator on the unit blinks).

#### Settings

<u>Off</u>	(This setting is available only when “HDMI Control” is set to “Off”.) Does not output videos/audio to the TV.
On	Outputs videos/audio to the TV. (The unit consumes more power than when “Off” is selected.)
Auto	Outputs videos/audio to the TV. If no signals are detected, the unit is set to the power saving mode.

## Network

Configures the network settings.



### Network Connection

Selects the network connection method.

#### Settings

Wired	Select this option when you want to connect the unit to a network with a commercially-available network cable (p.50).
Wireless (Wi-Fi)	Select this option when you want to connect the unit to a network via the wireless router (access point). For details on settings, see “Connecting the unit to a wireless network” (p.67).
Wireless Direct	Select this option when you want to connect a mobile device to the unit directly. For details on settings, see “Connecting a mobile device to the unit directly (Wireless Direct)” (p.72).

### IP Address

Configures the network parameters (such as IP address).

#### DHCP

Select whether to use a DHCP server.

#### Settings

<u>Off</u>	Does not use a DHCP server. Configure the network parameters manually. For details, see “Manual network settings”.
On	Uses a DHCP server to automatically obtain the unit’s network parameters (such as IP address).

## Manual network settings

- 1 Set “DHCP” to “Off”.
- 2 Use the cursor keys (▲/▼) to select a parameter type and press ENTER.

IP Address	Specifies an IP address.
Subnet Mask	Specifies a subnet mask.
Default Gateway	Specifies the IP address of the default gateway.
DNS Server (P)	Specifies the IP address of the primary DNS server.
DNS Server (S)	Specifies the IP address of the secondary DNS server.

- 3 Use the cursor keys (◀/▶) to move the edit position and the cursor keys (▲/▼) to select a value.
- 4 To confirm the setting, press ENTER.
- 5 To configure another network parameter, repeat steps 2 to 4.
- 6 To save the changes, use the cursor keys to select “OK” and press ENTER.
- 7 To exit from the menu, press ON SCREEN.

## Network Standby

Selects whether the unit can be turned on from other network devices (network standby).

### Settings

Off	Disables the network standby function.
On	Enables the network standby function. (The unit consumes more power than when “Off” is selected.)
Auto	Enables the network standby function. (If “Network Connection” is set to “Wired”, the unit is set to the power saving mode when the network cable is disconnected.)



With an advanced energy saving design, this product achieves a low power consumption of not more than two watts when in Network Standby mode.

## MAC Address Filter

Sets the MAC address filter to limit access to the unit from other network devices.

### Filter

Enables/disables the MAC address filter.

### Settings

Off	Disables the MAC address filter.
On	Enables the MAC address filter. In “MAC Address 1-10”, specify the MAC addresses of the network devices that will be permitted access to the unit.



AirPlay (p.108) and DMC (p.129) operations are not subject to the MAC address filter.

### MAC Address 1-10

Specifies the MAC addresses (up to 10) of the network devices that will be permitted access to the unit when “Filter” is set to “On”.

### Procedure

- 1 Use the cursor keys (▲/▼) to select “MAC Address 1-5” or “MAC Address 6-10” and press ENTER.
- 2 Use the cursor keys (▲/▼) to select an MAC address number and press ENTER.
- 3 Use the cursor keys (◀/▶) to move the edit position and the cursor keys (▲/▼) to select a value.
- 4 To confirm the setting, press ENTER.
- 5 To save the changes, use the cursor keys to select “OK” and press ENTER.
- 6 To exit from the menu, press ON SCREEN.

## Network Name

Edits the network name (the unit's name on the network) displayed on other network devices.

### Setup procedure

- 1 Press ENTER to enter the name edit screen.
- 2 Use the cursor keys and ENTER to rename and select "ENTER" to confirm the entry.



To clear the entry, select "CLEAR".

- 3 Use the cursor keys to select "OK" and press ENTER.



To restore the default setting, select "RESET".

- 4 To exit from the menu, press ON SCREEN.

## MusicCast Link Power Interlock

Selects whether turning on the power of the master device of the MusicCast network (the unit) also turns on the power of other devices of the network.

### Settings

<u>Off</u>	Disables the power interlock from the unit (MusicCast master).
On	Enables the power interlock from the unit (MusicCast master).

## Bluetooth

Configures the Bluetooth settings.



## Bluetooth

Enables/disables the Bluetooth function (p.95).

### Settings

Off	Disables the Bluetooth function.
<u>On</u>	Enables the Bluetooth function.

## Audio Receive

Configures the Bluetooth settings when the unit is used as the Bluetooth audio receiver.

## Bluetooth Standby

Selects whether to enable/disable the function that turns on the unit from Bluetooth devices (Bluetooth standby). If this function is set to "On", the unit automatically turns on when a connect operation is performed on the Bluetooth device.

### Settings

Off	Disables the Bluetooth standby function.
<u>On</u>	Enables the Bluetooth standby function. (The unit consumes more power than when "Off" is selected.)



This setting is not available when "Network Standby" (p.151) is set to "Off".



## Audio Send

Configures the Bluetooth settings when the unit is used as the Bluetooth audio transmitter.

### Transmitter

Enables/disables the Bluetooth audio transmitter function.

When this function is enabled, you can enjoy audio played back on the unit using Bluetooth speakers/headphones (p.96).

#### Settings

Off	Disables the Bluetooth audio transmitter function.
On	Enables the Bluetooth audio transmitter function.

## Multi Zone

Configures the multi zone settings.



## Main Zone Set

Configures the main zone setting.

### Zone Rename

Changes the zone name (for main zone) displayed on the front display or TV screen.

#### Setup procedure

- 1 Press ENTER to enter the name edit screen.
- 2 Use the cursor keys and ENTER to rename and select “ENTER” to confirm the entry.

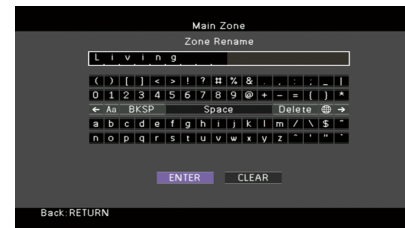

To clear the entry, select “CLEAR”.

- 3 Use the cursor keys to select “OK” and press ENTER.



To restore the default setting, select “RESET”.

- 4 To exit from the menu, press ON SCREEN.

## Zone2 Set, Zone3 Set

Configures the Zone2 or Zone3 settings.

### Volume

Enables/disables volume adjustments for Zone2 or Zone3 output.

If you have connected an external amplifier with volume control to the unit, disable the volume adjustment for the corresponding zone.

#### Settings

Fixed	Disables volume adjustments for Zone2 or Zone3 output.
Variable	Enables volume adjustments for Zone2 or Zone3 output.



This setting is not available depending on the “Power Amp Assign” setting (p.140).

### Max Volume

Sets the Zone2 or Zone3 limit value of the volumes.

#### Setting range

-30.0 dB to +15.0 dB (5.0 dB increments), +16.5 dB



This setting is available only when “Volume” is set to “Variable”.

### Initial Volume

Sets the Zone2 or Zone3 initial volume for when the unit is turned on.

#### Settings

Off	Sets the level at the volume level of the unit when it last entered standby mode.
On	Sets at Mute or the specified volume level (-80.0 dB to +16.5 dB, 0.5 dB increments). (Specify a volume level which is lower than the “Max Volume” setting.)



This setting is available only when “Volume” is set to “Variable”.

### Audio Delay

Adjusts the audio output timing for Zone2 or Zone3 so that the audio is synchronized with the video.

#### Setting range

0 ms to 100 ms (1 ms increments)

### Mono

Switches between stereo and monaural for Zone2 or Zone3 output.

#### Settings

Off	Produces stereo sounds in Zone2 or Zone3.
On	Produces monaural sounds in Zone2 or Zone3.

### Enhancer

Enables/disables Compressed Music Enhancer (p.83) for Zone2 or Zone3 output.

#### Settings

Off	Disables Compressed Music Enhancer.
On	Enables Compressed Music Enhancer.

### Tone Control

Adjusts the level of high-frequency range (Treble) and low-frequency range (Bass) for Zone2 or Zone3 output.

#### Settings

Auto	Adjusts the levels of the high-frequency range (Treble) and low-frequency range (Bass) automatically in synchronization with the main volume, with correction for the auditory response of the human ear.
Manual	Adjusts the level of high-frequency range (Treble) and low-frequency range (Bass) manually (-6.0 to +6.0 dB, 0.5 dB increments).
Bypass	Does not adjust the level of high-frequency range (Treble) and low-frequency range (Bass).

## Extra Bass

Enables/disables Extra Bass for Zone2 or Zone3 output. When Extra Bass is enabled, you can enjoy enhanced bass sounds, regardless of the size of speakers.

### Settings

<u>Off</u>	Disables Extra Bass.
On	Enables Extra Bass.

## Balance

Adjusts the front speaker balance for Zone2 or Zone3 output.

### Setting range

-20 to 0 to +20 (negative to the left and positive to the right)

## Zone Rename

Changes the zone name (for Zone2 or Zone3) displayed on the front display or TV screen.

You can change the zone name in the same manner as “Zone Rename” in “Main Zone Set” (p.153).

## Zone4 Set

Configures the Zone4 settings.

## Zone Rename

Changes the zone name (for Zone4) displayed on the front display or TV screen.

You can change the zone name in the same manner as “Zone Rename” in “Main Zone Set” (p.153).

## HDMI OUT2 Assign

Select the zone for which the HDMI OUT 2 (ZONE OUT) jack is used.

### Settings

Main, Zone2, Zone4



For details on audio signals that can be output to each zone, see “Multi-zone output” (p.188).

## Zone2 - Audio Output

Enables/disables the audio output from the HDMI OUT 2 jack when “HDMI OUT2 Assign” is set to “Zone2”.

On	Enables the audio output.
<u>Off</u>	Disables the audio output (video output only).

## Party Mode Set

Enables/disables switching to the party mode (p.115) for each zone.

### Choice

Target: Zone2, Target: Zone3, Target: Zone4

### Settings

Disable	Disables switching to the party mode.
<u>Enable</u>	Enables switching to the party mode. You can turn on/off the party mode by pressing PARTY on the remote control.

## Function

Configures the functions that make the unit easier to use.



## Input Assignment

Assigns the COMPONENT VIDEO, COAXIAL and OPTICAL jacks to another input source.

### Procedure

Example: assigning the OPTICAL (2) jack to the input source “AV 2”

- 1 Use the cursor keys to select the cell at the intersection of “AV 2” and “Optical”, and press ENTER.

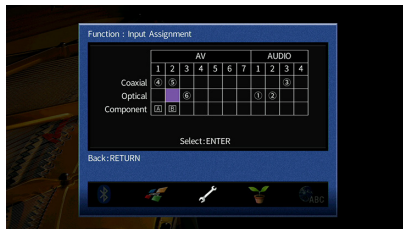

- 2 Use the cursor keys to select “2” and press ENTER.

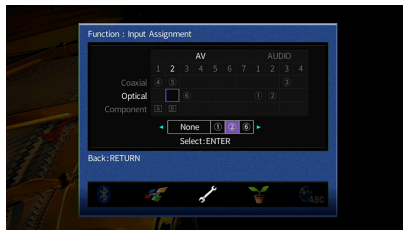

- 3 To exit from the menu, press ON SCREEN.



You cannot assign both COAXIAL and OPTICAL jacks to the same input source.

## Remote PROGRAM Key

Assigns the desired function to the PROGRAM keys of the remote control.

For example, when “INPUT Selection” is selected, the PROGRAM keys will operate as the input switching keys.

### Settings

DSP Program Selection	Select a sound program.
INPUT Selection	Select an input source for playback.
NET Selection	Select a network source.
Preset Selection	Select a registered item (shortcut).
Browse Screen - 1 Page Up/Down	Move to the previous/next page of the browse screen list.
Subwoofer Trim	Adjust the subwoofer volume.
Dialogue Level	Adjust the volume of dialogue sounds.
▲ Repeat / ▼ Shuffle	Select the repeat/shuffle setting for the USB storage device or media server.

## Display Set

Configures the settings related to the front display and TV screen display.

### Dimmer (Front Display)

Adjusts the brightness of the front display.

#### Setting range

-4 to 0 (higher to brighten)



The front display may become dark when “ECO Mode” (p.159) is set to “On”.

### Short Message

Selects whether to display short messages on the TV screen when the unit is operated (such as input selection and volume adjustment).

### Settings

On	Displays short messages on the TV screen.
Off	Does not display short messages on the TV screen.

## Wallpaper

Selects the image to be used as wallpaper on the TV.

### Settings

<u>Piano</u>	Displays the piano image on the TV screen when there is no video signal.
Gray	Displays a gray background on the TV screen when there is no video signal.

## Trigger Output1, Trigger Output2

Sets the TRIGGER OUT 1-2 jacks to function in sync with the power status of each zone or input switching.

## Trigger Mode

Specifies the condition for the TRIGGER OUT jack to function.

### Settings

<u>Power</u>	The TRIGGER OUT jack functions in sync with the power status of the zone specified with "Target Zone".
Source	The TRIGGER OUT jack functions in sync with the input switching in the zone specified with "Target Zone". An electronic signal is transmitted according to the setting made in "Source."
Manual	Select this to manually switch the output level for electronic signal transmission with "Manual".

### Source

Specifies the output level of the electronic signal transmitted with each input, switching when "Trigger Mode" is set to "Source".

### Choices

AV 1-7, VIDEO AUX, AUDIO 1-4\*, PHONO, TUNER, (network sources), Bluetooth, USB

\* AUDIO 4: RX-V3083 only

### Settings

Low	Stops the electronic signal transmission when you switch to the input source specified in this option.
<u>High</u>	Transmits the electronic signal when you switch to the input source specified in this option.

## Manual

Switches the output level for electronic signal transmission manually when "Trigger Mode" is set to "Manual". This setting can also be used to confirm proper function of the external device connected via the TRIGGER OUT jack.

### Choices

Low	Stops the electronic signal transmission.
<u>High</u>	Transmits the electronic signal.

## Target Zone

Specifies the zone with which the TRIGGER OUT jack functions are synchronized.

### Settings

Main	When "Trigger Mode" is set to "Power", electronic signal transmission is synchronized with the power status of the main zone. When "Trigger Mode" is set to "Source", electronic signal transmission is synchronized with the input switching in the main zone.
Zone2	When "Trigger Mode" is set to "Power", electronic signal transmission is synchronized with the power status of Zone2. When "Trigger Mode" is set to "Source", electronic signal transmission is synchronized with the input switching in Zone2.
Zone3	When "Trigger Mode" is set to "Power", electronic signal transmission is synchronized with power status of Zone3. When "Trigger Mode" is set to "Source", electronic signal transmission is synchronized with input switching in Zone3.
Zone4	When "Trigger Mode" is set to "Power", electronic signal transmission is synchronized with power status of Zone4. When "Trigger Mode" is set to "Source", electronic signal transmission is synchronized with input switching in Zone4.
<u>All</u>	When "Trigger Mode" is set to "Power", electronic signal transmission is synchronized with the power status of any zone. When "Trigger Mode" is set to "Source", electronic signal transmission is synchronized with the input switching in any zone.

## Memory Guard

Prevents accidental changes to the settings.

### Settings

Off	Does not protect the settings.
On	Protects the settings until "Off" is selected.



When "Memory Guard" is set to "On", the lock icon (🔒) is displayed on the menu screen.

Icon

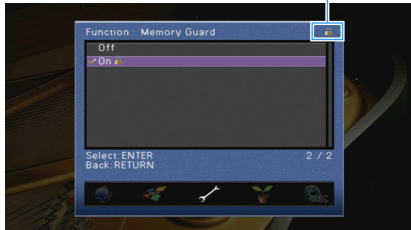

## ECO

Configures the power supply settings.



## Auto Power Standby

Sets the amount of time for the auto-standby function. If you do not operate the unit or if no input signals are detected for the specified time, the unit will automatically go into standby mode.

### Settings

Off	Does not set the unit to standby mode automatically.
20 Minutes	Sets the unit to standby mode when you have not operated the unit and no input signals are detected for 20 minutes.
2 Hours, 4 Hours, 8 Hours, 12 Hours	Sets the unit to standby mode when you have not operated the unit for the specified time. For example, when "2 Hours" is selected, the unit will switch to standby mode if you do not operate it for 2 hours.



Just before the unit enters standby mode, "AutoPowerStdby" appears and then countdown starts in the front display.

## ECO Mode

Enables/disables the eco (power saving) mode.

You can reduce the unit's power consumption by setting "ECO Mode" to "On". After setting, be sure to press ENTER to restart the unit.

### Settings

Off	Disables the eco mode.
On	Enables the eco mode.



- When "ECO Mode" is set to "On", the front panel display may become dark.
- If you want to play audio at high volume, set "ECO Mode" to "Off".

## Language

Select an on-screen menu language.

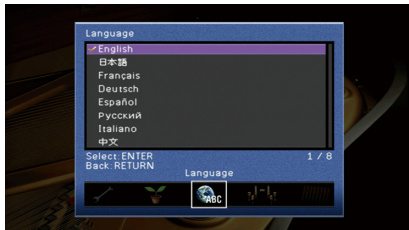

### Settings

English, Japanese, French, German, Spanish, Russian, Italian, Chinese



The information on the front display is provided in English only.

## Viewing information about the unit (Information menu)

You can view information about the unit using the TV screen.



If new firmware is available,  (mail icon) appears at the upper right of the "Information". For details, see "Updating the unit's firmware via the network" (p.169).

- 1 Press ON SCREEN.
- 2 Use the cursor keys to select "Information" and press ENTER.

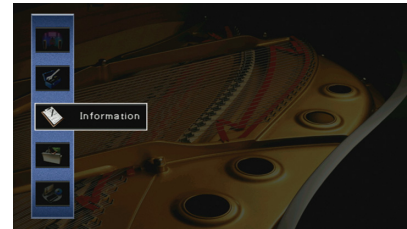

- 3 Use the cursor keys (◀/▶) to select an information type.

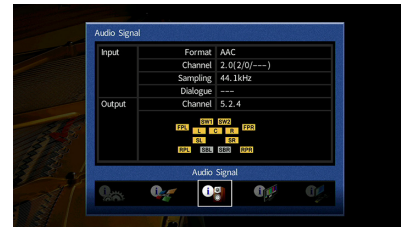

- 4 To exit from the menu, press ON SCREEN.

## Types of information

You can check the following information in the Information menu.

### ■ Audio Signal

Displays information about the current audio signal.

Input	Format	Audio format of the input signal
	Channel	The number of source channels in the input signal (front/surround/LFE)
		For example, “5.1 (3/2/0.1)” means 5.1ch in total (3 front channels, 2 surround channels, and LFE).
	Sampling	The number of samples per second of the input digital signal
Dialogue	The dialogue normalization level of the input bitstream signal	
Output	Channel	The number of signal output channels (for example, “5.1.2” denotes “standard 5.1-channel plus 2 for overhead speaker channels”) and the speaker terminals from which signals are output



- Even when the unit is set to output bitstream signals directly, the signal may be converted depending on the specifications and settings of the playback device.
- Some information may not be available depending on the signal type.

### ■ Video Signal

Displays information about the current video signal.

HDMI Signal	Presence or absence of HDMI signal input/output
HDMI Resolution	Resolutions of input signal (analog or HDMI) and output signal (HDMI)
Analog Resolution	Resolutions of input signal (analog)

### ■ HDMI Monitor

Displays information about the TVs connected to the HDMI OUT jacks.

Use the cursor keys (▲/▼) to switch between “OUT1” and “OUT2”.

Interface	TV interface
Video Resolution	Resolutions supported by the TV

### ■ Network

Displays the network information on the unit.

#### (When using wired or wireless [Wi-Fi] network connection)

IP Address	IP address
Subnet Mask	Subnet mask
Default Gateway	The IP address of the default gateway
DNS Server (P)	The IP address of the primary DNS server
DNS Server (S)	The IP address of the secondary DNS server
MAC Address (Ethernet)	MAC address
MAC Address (Wi-Fi)	
Network Name	Network name (the unit's name on the network) (p.152)
MusicCast Network	The status of the MusicCast network connection
Wired/Wireless	The status of the wired or wireless connection
SSID	(When using wireless [Wi-Fi] network connection) The SSID of the wireless network



### (When using Wireless Direct)

SSID	The SSID of the wireless network
Security	Security method
Security Key	Security key
IP Address	IP address
Subnet Mask	Subnet mask
MAC Address (Wi-Fi)	MAC address
MusicCast Network	The status of the MusicCast network connection
Network Connection	“Wireless Direct” indication

## System

Displays the system information on the unit.

Remote ID	The unit's remote control ID setting (p.163)
TV Format	The unit's video signal type (p.163)
Speaker Impedance	The speaker impedance setting of the unit (p.162)
System ID	System ID number
Firmware Version	The version of firmware installed on the unit



If the unit detects a newer firmware over the network,  (mail icon) appears at the upper right of the “Information” and “System” icons, and the corresponding message will be displayed in this screen. You can update the unit's firmware by pressing ENTER in this screen and following the procedure in “Updating the unit's firmware via the network” (p.169).

## Multi Zone

Displays information about Zone2, Zone3 and Zone4.

Input	The input source selected for Zone2, Zone3 or Zone4
Volume	The volume for Zone2 or Zone3

## Configuring the system settings (ADVANCED SETUP menu)

Configure the system settings of the unit while viewing the front display.

- 1 Set the unit to standby mode.
- 2 While holding down STRAIGHT on the front panel, press MAIN ZONE .

MAIN ZONE  STRAIGHT

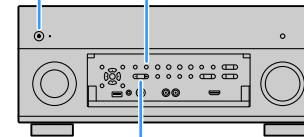

PROGRAM

- 3 Press PROGRAM to select an item.
- 4 Press STRAIGHT to select a setting.
- 5 Press MAIN ZONE  to set the unit to standby mode and turn it on again.

The new settings take effect.

## ADVANCED SETUP menu items



Default settings are underlined.

Item	Function	Page
SPEAKER IMP.	Changes the speaker impedance setting.	162
REMOTE SENSOR	Turns on/off of the remote control sensor on the main unit.	162
REMOTE ID	Selects the unit's remote control ID.	163
TV FORMAT	Switches the video signal type.	163
MONITOR CHECK	Removes the limitation on HDMI video output.	163
4K MODE	Selects the HDMI 4K (60 Hz/50 Hz) signal format.	164
DTS MODE	Switches the DTS format notification setting.	164
RECOV./BACKUP	Creates backup of the settings of the unit, or recovers the settings from the backup.	164
INITIALIZE	Restores the default settings.	165
FIRM. UPDATE	Updates the firmware.	165
VERSION	Checks the version of firmware currently installed on the unit.	165

## Changing the speaker impedance setting (SPEAKER IMP.)



Change the unit's speaker impedance settings depending on the impedance of the speakers connected.

### Settings

<u>6 Ω MIN</u>	Select this option when you connect 6-ohm speakers to the unit. You can also use 4-ohm speakers as the front speakers.
<u>8 Ω MIN</u>	Select this option when you connect 8-ohm or higher speakers to the unit.

## Turning on/off the remote control sensor (REMOTE SENSOR)



Turn on/off the remote control sensor on the main unit. While the remote control sensor is turned off, you cannot control the unit from the remote control.

### Settings

<u>ON</u>	Turns on the remote control sensor.
OFF	Turns off the remote control sensor.

## Selecting the remote control ID (REMOTE ID)



Change the unit's remote control ID so that it matches the remote control's ID (default: ID1). When using multiple Yamaha AV receivers, you can set each remote control with a unique remote control ID for its corresponding receiver.

### Settings

ID1, ID2

#### ■ Changing the remote control ID of the remote control

- 1 To select ID1, hold down the cursor key (◀) and SCENE1 together for 3 seconds.  
To select ID2, hold down the cursor key (◀) and SCENE2 together for 3 seconds.

## Switching the video signal type (TV FORMAT)



Switch the video signal type of the unit so that it matches to the format of your TV.

### Settings

NTSC, PAL

## Removing the limitation on HDMI video output (MONITOR CHECK)



The unit automatically detects resolutions supported by a TV connected to the HDMI OUT jack. Disable the monitor check function if you want to specify a resolution in "Resolution" (p.147) when the unit cannot detect the TV's resolution or when you want to specify a different resolution than the detected resolution.

### Settings

<u>YES</u>	Enables the monitor check function. (Outputs video signals with a resolution supported by the TV only.)
SKIP	Disables the monitor check function. (Outputs video signals with a specified resolution regardless of compatibility with the TV.)



Reset to "YES" if the unit becomes inoperable because video from the unit cannot be displayed on the TV after "MONITOR CHECK" has been set to "SKIP".

## Selecting the HDMI 4K signal format (4K MODE)



Selects the format of signals input/output at the unit when HDMI 4K compatible TV and playback device are connected to the unit.

### Settings

	Inputs/outputs 4K signals shown in the table below.
<u>MODE 1</u>	Depending on the connected device or HDMI cables, video may not be displayed correctly. In this case, select "MODE 2".
MODE 2	Inputs/outputs 4K signals shown in the table below.

### Format

		MODE 1			MODE 2		
		8 bit	10 bit	12 bit	8 bit	10 bit	12 bit
4K/60, 50 Hz	RGB 4:4:4	✓	—	—	—		
	YCbCr 4:4:4	✓	—	—	—		
	YCbCr 4:2:2	✓			—		
	YCbCr 4:2:0	✓			✓	—	
4K/30, 25, 24 Hz	RGB 4:4:4	✓			✓	—	
	YCbCr 4:4:4	✓			✓	—	
	YCbCr 4:2:2	✓			✓		



- When "MODE 1" is selected, use a Premium High Speed HDMI Cable or Premium High Speed Cable with Ethernet.
- Regardless of the setting, 4K signals are input as "MODE 2" for the VIDEO AUX (HDMI IN) jack.

## Switching the DTS format notification setting (DTS MODE)



Switches the DTS format notification setting.

This setting informs the video device (such as BD/DVD player) about the DTS formats that the unit supports.

### Settings

<u>MODE 1</u>	This mode conforms to the DTS:X standard. Use this setting under normal circumstances.
MODE 2	Use this setting if the video device (such as BD/DVD player) fails to properly output a DTS signal even when it is playing back DTS-HD or DTS:X content.

## Backing up/recovering the settings (RECOV./BACKUP)



Creates backup of the settings of the unit, or recovers the settings from the backup.

### Backup/recovery procedure

- Press STRAIGHT repeatedly to select "BACKUP" or "RECOVERY" and press INFO to start the process.

### Choices

BACKUP	Creates backup of the settings of the unit in the internal memory.
RECOVERY	Recovers the settings of the unit from the backup (available only when backup has been created).

### Note

- Do not turn off the unit during the recovery process. Otherwise, the settings may not be restored correctly.
- The backup does not contain user information (such as user accounts and passwords).

## Restoring the default settings (INITIALIZE)



Restores the default settings for the unit.

### Choices

VIDEO	Restores the default settings for video configurations.
ALL	Restores the default settings for the unit.
CANCEL	Does not perform an initialization.

## Updating the firmware (FIRM. UPDATE)



New firmware that provides additional features or product improvements will be released as needed. Updates can be downloaded from the Yamaha website. If the unit is connected to the Internet, you can download the firmware via the network. For details, refer to the information supplied with updates.

### Firmware update procedure

Do not perform this procedure unless firmware update is necessary. Also, make sure you read the information supplied with updates before updating the firmware.

- 1 Press STRAIGHT repeatedly to select “USB” or “NETWORK” and press INFO to start firmware update.

### Choices

USB	Update the firmware using a USB memory device.
NETWORK	Update the firmware via the network.



If the unit detects newer firmware over the network, the corresponding message will be displayed after ON SCREEN is pressed. In this case, you can also update the unit’s firmware by following the procedure in “Updating the unit’s firmware via the network” (p.169).

## Checking the firmware version (VERSION)



Check the version of firmware currently installed on the unit.



- You can also check the firmware version in “System” (p.161) in the “Information” menu.
- It may take a while until the firmware version is displayed.

## Controlling external devices with the remote control

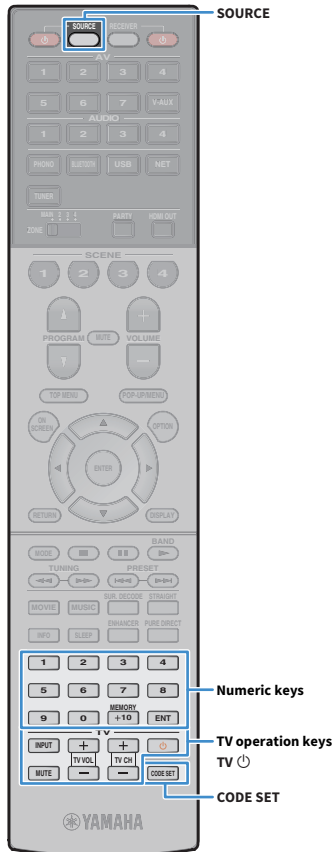

You can use the unit's remote control to operate external devices (such as BD/DVD players) if you have registered the remote control code of the external device.



- You cannot control an external device that does not have a remote control sensor.
- Ensure that the remote control ID of the external device is set to "ID1". If any other ID is selected, the remote control operations may not work properly.
- If the unit's remote control is without batteries for more than 2 minutes, the registered codes may be cleared. If this happens, insert new batteries and register the codes again.



Under the unit's default settings, the amplifier code (Yamaha: 5098) is set for all the input selection keys. With this setting, you can control HDMI Control-compatible devices connected to the unit with the remote control. (This function may not work depending on the specification of the external device.)

## Registering the remote control code for a TV

You can use the unit's remote control to operate a TV if you have registered its remote control code.



You can also register your TV's remote control code to the unit's input selection keys (p.167). This would allow you to use the cursor keys or numeric keys to operate the TV (this function may not be available on some TV models).

- 1 See "List of remote control codes" (p.196) to find your TV's remote control code.



If there are multiple remote control codes, register the first code in the list. If that does not work, try the other codes.

- 2 Press **CODE SET**.

SOURCE blinks twice.

Perform each of the following steps within 1 minute. Otherwise, the setting will be canceled. If this happens, repeat from Step 2.

- 3 Press **TV** .

- 4 Use the numeric keys to enter the 4-digit remote control code.

Once the remote control code is successfully registered, SOURCE blinks twice.

If it blinks six times, registration has failed. Repeat from Step 2.

## TV operations

Once you have registered the remote control code for your TV, you can control it using the TV operation keys, regardless of the input source selected on the unit.

	INPUT	Switches the video inputs of the TV.
	MUTE	Mutes the audio output of the TV.
TV operation keys	TV VOL	Adjust the volume of the TV.
	TV CH	Switch the channels of the TV.
	TV 	Turns on/off the TV.

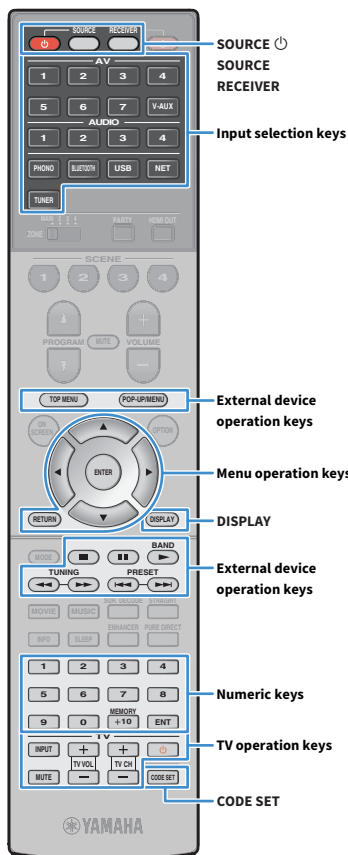

## Registering the remote control codes for playback devices

You can use the unit's remote control to operate playback devices if you have registered their remote control codes. You can also use the input selection keys to change the playback devices that are controlled by the remote control, because their remote control codes are assigned to the input selection keys.

- 1 See "List of remote control codes" (p.196) to find the remote control code for your playback device.



If there are multiple remote control codes, register the first code in the list. If that does not work, try the other codes.

- 2 Press CODE SET.

SOURCE blinks twice.

Perform each of the following steps within 1 minute. Otherwise, the setting will be canceled. If this happens, repeat from Step 2.

- 3 Press the input selection key.

For example, press AV 1 to set the remote control code for the playback device connected to the AV 1 jack.

- 4 Use the numeric keys to enter the 4-digit remote control code.

Once the remote control code is registered successfully, SOURCE blinks twice.

If it blinks six times, registration has failed. Repeat from Step 2.



For details on how to register a remote control code to a SCENE key, refer to "Registering a scene" (p.77).

## Playback device operations

Once you have registered the remote control code for your playback device, you can control it using the following keys after selecting the input source or scene.



By pressing SOURCE or RECEIVER, you can switch the devices (the unit or external device) that are operated by the menu operation keys, DISPLAY and numeric keys. You can operate the unit after pressing RECEIVER (lights up in orange), and an external device after pressing SOURCE (lights up in green). For example, if you register the remote control code of your external device on TUNER, you can operate the unit's built-in FM/AM radio after pressing RECEIVER and the external device after pressing SOURCE.

SOURCE		Turns on/off the playback device.
Menu operation keys	Cursor keys	Select an item.
	ENTER	Confirms a selected item.
	RETURN	Returns to the previous screen.
DISPLAY		Switches information on the display.
External device operation keys	TOP MENU	Displays the top menu.
	POP-UP/MENU	Displays the pop-up menu.
		Stops playback.
		Stops playback temporarily.
		Starts playback of the selected song/video.
		Searches forward/backward (by holding down).
External device operation keys		Skips forward/backward.
	Numeric keys	Enter numerical values.
TV operation keys		Control the TV (p.166).



These keys work only if the corresponding function is available on your playback device and if the device can be operated with an infrared remote control.

## Resetting remote control codes

You can reset a remote control code registered to each input selection key.

### 1 Press CODE SET.

SOURCE blinks twice.

Perform each of the following steps within 1 minute. Otherwise, the setting will be canceled. If this happens, repeat from Step 1.

### 2 Press the input selection key.

### 3 Use the numeric keys to enter “5098”.

Once the remote control code is reset successfully, SOURCE blinks twice.

If it blinks six times, resetting has failed. Repeat from Step 1.

To reset the remote control to factory default settings

- 1 Press CODE SET.
- 2 Press RECEIVER.
- 3 Use the numeric keys to enter “9981”.

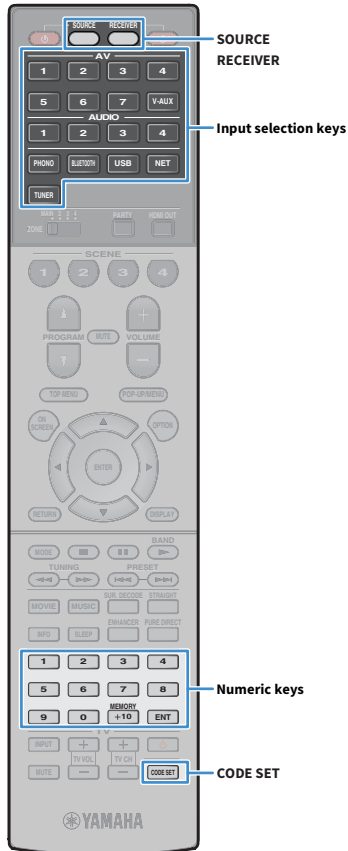



# Updating the unit's firmware via the network

New firmware that provides additional features or product improvements will be released as needed. If the unit is connected to the Internet, you can download the firmware via the network and update it.

### Note

- Do not operate the unit or disconnect the power cable or network cable during firmware update. Firmware update takes about 20 minutes or more (depending on your Internet connection speed).
- If the unit is connected to the wireless network, network update may not be possible depending on the condition of the wireless connection. In this case, update the firmware using the USB memory device (p.165).
- For details on update, visit the Yamaha website.



- You can also update the firmware using the USB memory device from the "ADVANCED SETUP" menu (p.165).
- The firmware update indicator (p.15) on the front display lights up when a firmware update is available via the network.

A firmware update is available if the following message is displayed after ON SCREEN is pressed.

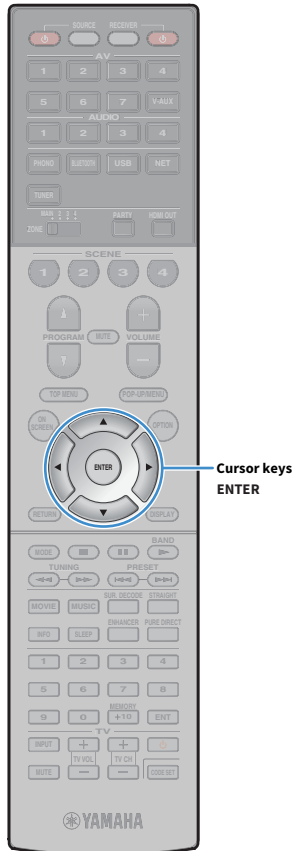
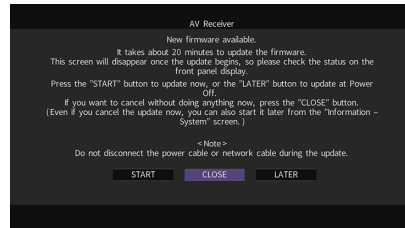

Cursor keys  
ENTER

# Updating the unit's firmware immediately

- 1 Read the on-screen description.
- 2 To start the firmware update, use the cursor keys to select "START" and press ENTER.
- 3 If "UPDATE SUCCESS PLEASE POWER OFF!" appears on the front display, press MAIN ZONE  on the front panel.

The firmware update is complete.



If you want to cancel without doing anything now, select "CLOSE".  (mail icon) appears at the upper right of the "Information" and "System" icons, and a message will be displayed in the "System" screen (p.161). You can update the unit's firmware by pressing ENTER in the "System" screen.

Information icon

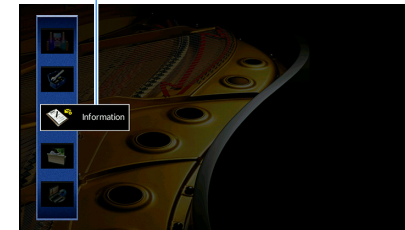

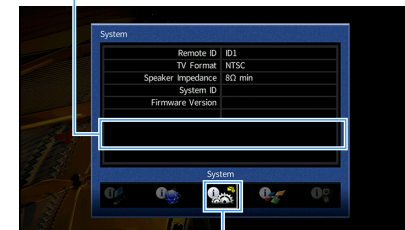

Message

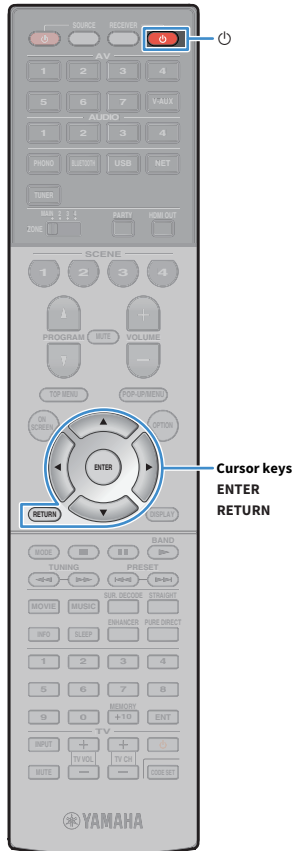

System Icon

## Updating the unit's firmware at power off



- 1 Read the on-screen description.
- 2 To set the firmware to update at power off, use the cursor keys to select “LATER” and press ENTER.
- 3 Press  (receiver power) to turn off the unit.

The following message is displayed on the front display.

Firmware update indicator (flashes)



The unit turns off automatically without performing the firmware update 2 minutes after Step 3.

- 4 To start the firmware update, press ENTER.



- To cancel the firmware update and turn off the unit, press RETURN.
- You can also start the firmware update by pressing INFO on the front panel.
- The unit turns off without performing the firmware update if you turn off the unit with AV CONTROLLER or MusicCast CONTROLLER.

If the firmware update is complete, the unit turns off automatically.

# APPENDIX

## Frequently asked questions

### **The new speaker system does not provide an ideal sound balance...**

If you have changed speakers or have a new speaker system, use “Auto Setup” to optimize the speaker settings again (p.54). If you want to adjust the speaker settings manually, use “Manual Setup” in the “Setup” menu (p.140).

### **Since we have small children, we want to set limitations on the volume control...**

If a small child accidentally operates the controls on the main unit or remote control, the volume may suddenly increase. This may also cause injury or damage the unit or speakers. We recommend using “Max Volume” in the “Setup” menu to set the maximum volume level for the unit in advance (p.146). You can also set the maximum volume for Zone2 or Zone3 (p.154).

### **I am occasionally startled by a sudden loud sound when turning on the unit...**

By default, the volume level when the unit last entered standby mode is automatically applied. If you want to fix the volume, use “Initial Volume” in the “Setup” menu to set the volume to be applied when the receiver is turned on (p.146). You can also set the initial volume for Zone2 or Zone3 (p.154).

### **We are bothered by volume differences when switching between input sources...**

You can correct volume differences between input sources by utilizing “Input Trim” in the “Option” menu (p.126).

### **I made HDMI connections but HDMI Control does not work at all...**

To use HDMI Control, you need to perform the HDMI Control link setup (p.188). After connecting HDMI Control-compatible devices (such as BD/DVD players) to the unit, enable HDMI Control on each device and perform the HDMI Control link setup. This setup is required

every time you add a new HDMI Control-compatible device to your system. For information on how HDMI Control works between your TV and playback devices, refer to the instruction manuals for each device.

### **I want to turn off the on-screen messages displayed during operations...**

By default, short messages are displayed on the TV screen when the unit is operated (such as input selection and volume adjustment). If the short messages bother you when you are watching movies or sports, configure “Short Message” (p.156) in the “Setup” menu to turn off the short messages.

### **I want to prevent accidental changes to the settings...**

You can protect the settings configured on the unit (such as speaker settings) by utilizing “Memory Guard” in the “Setup” menu (p.158).

### **The unit’s remote control is simultaneously controlling another Yamaha product as well as the unit...**

When using multiple Yamaha products, the remote control may work on another Yamaha product or another remote control may work on the unit. If this happens, register different remote control IDs for the devices that you want to control with each remote control (p.163).

### **I want to enjoy videos/audio played back on the video device even when the unit is in standby mode...**

If you have connected a video device to the unit with HDMI, you can output videos/audio played back on the video device to the TV even when the unit is in standby mode. To use this function, set “Standby Through” (p.150) in the “Setup” menu to “On” or “Auto”. You can also switch the input source using the remote control of the unit when this function is enabled.

## Troubleshooting

Refer to the table below when the unit does not function properly.

If the problem you are experiencing is not listed below or if the instructions below do not help, turn off the unit, disconnect the power cable, and contact the nearest authorized Yamaha dealer or service center.

### First, check the following:

- 1 The power cables of the unit, TV and playback devices (such as BD/DVD players) are connected to AC wall outlets securely.
- 2 The unit, subwoofer, TV and playback devices (such as BD/DVD players) are turned on.
- 3 The connectors of each cable are securely inserted in to jacks on each device.

### Power, system and remote control

Problem	Cause	Remedy
<b>The power does not turn on.</b>	The protection circuitry has been activated three times consecutively. When the unit is in this condition, the standby indicator on the unit blinks if you try to turn on the power.	As a safety precaution, capability to turn on the power is disabled. Contact your nearest Yamaha dealer or service center to request repair.
<b>The power does not turn off.</b>	The internal microcomputer has frozen, due to an external electric shock (such as lightning or excessive static electricity) or to a drop in the power supply voltage.	Hold down on the front panel for more than 10 seconds to initialize and reboot the unit. (If the problem persists, disconnect the power cable from the AC wall outlet and plug it again.)
<b>The power turns off (standby mode) immediately.</b>	The unit was turned on while a speaker cable was shorted.	Twist the bare wires of each speaker cable firmly and reconnect to the unit and speakers (p.29).
<b>The unit enters standby mode automatically.</b>	The sleep timer worked.	Turn on the unit and start playback again.
	The auto-standby function activated because the unit was not used for the specified time.	To disable the auto-standby function, set "Auto Power Standby" in the "Setup" menu to "Off" (p.158).
	The speaker impedance setting is incorrect.	Set the speaker impedance to match your speakers (p.162).
	The protection circuitry has been activated because of a short circuit.	Twist the bare wires of each speaker cable firmly and reconnect to the unit and speakers (p.29).
	The protection circuitry has been activated because the volume of the unit is too high.	Turn down the volume. If "ECO Mode" in the "Setup" menu is set to "On", set it to "Off" (p.159).
<b>The unit is not reacting.</b>	The internal microcomputer is frozen, due to an external electric shock (such as lightning or excessive static electricity) or to a drop in the power supply voltage.	Hold down MAIN ZONE  on the front panel for more than 10 seconds to initialize and reboot the unit. (If the problem persists, disconnect the power cable from the AC wall outlet and plug it again.)

Problem	Cause	Remedy
<b>The unit cannot be controlled using the remote control.</b>	The unit is out of the operating range.	Use the remote control within the operating range (p.6).
	The batteries are weak.	Replace with new batteries.
	The unit's remote control sensor is exposed to direct sunlight or strong lighting.	Adjust the lighting angle, or reposition the unit.
	The remote control is set to control external devices.	Press RECEIVER to set the remote control to control the unit (the key lights up in orange).
	The remote control IDs of the unit and the remote control are not identical.	Change the remote control ID of the unit or the remote control (p.163).
	The remote control sensor on the main unit is turned off.	Set "REMOTE SENSOR" in the "ADVANCED SETUP" menu to "ON" (p.162).
<b>External devices cannot be controlled using the remote control.</b>	The remote control is set to control the unit.	Press SOURCE to set the remote control to control external devices (the key lights up in green).
	The corresponding remote control code is not set properly.	Set the remote control code again (p.166). Even if the remote control code is registered properly, some products may not respond to the remote control.

# Audio

Problem	Cause	Remedy
<b>No sound.</b>	Another input source is selected.	Select an appropriate input source with the input selection keys.
	Signals that the unit cannot reproduce are being input.	Some digital audio formats cannot be played back on the unit. To check the audio format of the input signal, use "Audio Signal" in the "Information" menu (p.160).
	The cable connecting the unit and playback device is defective.	If there is no problem with the connection, replace with another cable.
<b>The volume cannot be increased.</b>	The maximum volume is set.	Use "Max Volume" in the "Setup" menu to adjust the maximum volume (p.146).
	A device connected to the output jacks of the unit is not turned on.	Turn on all devices connected to the output jacks of the unit.
<b>No sound is coming from a specific speaker.</b>	The playback source does not contain a signal for the channel.	To check it, use "Audio Signal" in the "Information" menu (p.160).
	The currently selected sound program/decoder does not use the speaker.	To check it, use "Test Tone" in the "Setup" menu (p.144).
	Audio output of the speaker is disabled.	Perform "Auto Setup" (p.54) or use "Configuration" in the "Setup" menu to change the speaker settings (p.141).
	The volume of the speaker is set too low.	Perform "Auto Setup" (p.54) or use "Level" in the "Setup" menu to adjust the speaker volume (p.144).
	The speaker cable connecting the unit and the speaker is defective.	If there is no problem with the connection, replace with another speaker cable.
	The speaker is malfunctioning.	To check it, replace with another speaker. If the problem persists, the unit may be malfunctioning.
<b>No sound is coming from the subwoofer.</b>	The playback source does not contain LFE or low-frequency signals.	To check if the subwoofer is working properly, use "Test Tone" in the "Setup" menu (p.144).
	Subwoofer output is disabled.	Perform "Auto Setup" (p.54) or set "Subwoofer 1" or "Subwoofer 2" in the "Setup" menu to "Use" (p.142).
	The volume of the subwoofer is too low.	Adjust the volume on the subwoofer.
	The subwoofer has been turned off by its auto-standby function.	Disable the auto-standby function of the subwoofer or adjust its sensitivity level.
<b>No sound from the playback device (connected to the unit with HDMI).</b>	The TV does not support HDCP (High-bandwidth Digital Content Protection).	Refer to the instruction manuals for the TV and check the TV's specifications.
	The number of devices connected to the HDMI OUT jack exceeds the limit.	Disconnect some of the HDMI devices.
<b>No sound from the playback device (when HDMI Control is used).</b>	The TV is set to output audio from the TV speakers.	Change the audio output setting on your TV so that the playback device audio is output from the speakers connected to the unit.
	TV audio is selected as the input source.	Select an appropriate input source with the input selection keys.

Problem	Cause	Remedy
<b>No sound from the TV (when HDMI Control is used).</b>	The TV is set to output audio from the TV speakers.	Change the audio output setting on your TV so that the TV audio is output from the speakers connected to the unit.
	A TV that does not support ARC is connected to the unit only with an HDMI cable.	Use a digital optical cable to make an audio connection (p.41).
	(If the TV is connected to the unit with an audio cable) The TV audio input setting does not match the actual connection.	Use "TV Audio Input" in the "Setup" menu to select the correct audio input jack (p.149).
	(If you are trying to use ARC) ARC is disabled on the unit or TV.	Set "ARC" in the "Setup" menu to "On" (p.149). Also, enable ARC on the TV.
<b>No sound from the Zone2 TV (connected to the unit with HDMI).</b>	The audio output from the HDMI OUT 2 (ZONE OUT) jack is disabled.	Set "Zone2 - Audio Output" in the "Setup" menu to "On" (p.155).
<b>Only the front speakers work on multichannel audio.</b>	The playback device is set to output 2-channel audio (such as PCM) only.	To check it, use "Audio Signal" in the "Information" menu (p.160). If necessary, change the digital audio output setting on the playback device.
<b>Noise/hum is heard.</b>	The unit is too close to another digital or radio frequency device.	Move the unit further away from the device.
	The cable connecting the unit and playback device is defective.	If there is no problem with the connection, replace with another cable.
<b>The sound is distorted.</b>	The volume of the unit is too high.	Turn down the volume. If "ECO Mode" in the "Setup" menu is set to "On", set it to "Off" (p.159).
	A device connected to the unit's output jacks is not turned on.	Turn on all devices connected to the unit's output jacks.
<b>The sound is interrupted.</b>	If the HDMI OUT 2 (ZONE OUT) jack is assigned to Zone2 or Zone4, HDMI audio output may be interrupted during some zone operations due to internal circuitry switching.	For details, see "Connecting an HDMI-compatible device to play back videos/audio" (p.112).

## Video

Problem	Cause	Remedy
<b>No video.</b>	Another input source is selected on the unit.	Select an appropriate input source with the input selection keys.
	Another input source is selected on the TV.	Switch the TV input to display the video from the unit.
	The video signal output from the unit is not supported by the TV.	Set "MONITOR CHECK" in the "ADVANCED SETUP" menu to "YES" (p.163).
	The cable connecting the unit and TV (or playback device) is defective.	If there is no problem with the connection, replace with another cable.
<b>No video from the playback device (connected to the unit with HDMI).</b>	The input video signal (resolution) is not supported by the unit.	To check the information about the current video signal (resolution), use "Video Signal" in the "Information" menu (p.160). For information about video signals supported by the unit, see "HDMI signal compatibility" (p.190).
	The TV does not support HDCP (High-bandwidth Digital Content Protection).	Refer to the instruction manuals for the TV and check the TV's specifications. If you want to play back contents that require HDCP 2.2-compatible devices, both the TV and playback device must support HDCP 2.2.
	The playback device that supports HDCP 2.2 is connected to the VIDEO AUX (HDMI IN) jack.	To play back contents that require HDCP 2.2-compatible devices, connect the playback device to the HDMI (AV 1-7) jack (p.44).
	The number of devices connected to the HDMI OUT jack is over the limit.	Disconnect some of the HDMI devices.
<b>The menu of the unit is not displayed on the TV.</b>	Another input source is selected on the TV.	Switch the TV input to display the video from the unit (HDMI OUT jack).
<b>The video is interrupted.</b>	(If you are using 2 TVs in the main zone) Another TV is turned off when "HDMI OUT 1+2" is selected.	Select "HDMI OUT 1" or "HDMI OUT 2" to output the signals only to the TV you are using (p.75).
	(If the HDMI OUT 2 jack is assigned to Zone2 or Zone4) HDMI audio output may be interrupted during some zone operations due to internal circuitry switching.	For details, see "Connecting an HDMI-compatible device to play back videos/audio" (p.112).



## FM/AM radio (AM radio feature is not available on the Australia model)

Problem	Cause	Remedy
<b>FM radio reception is weak or noisy.</b>	There is multi-path interference.	Adjust the FM antenna height or orientation, or place it in a different location.
	Your area is too far from the FM station transmitter.	Set "FM Mode" in the "Option" menu to "Mono" to select monaural FM radio reception (p.126). Use an outdoor FM antenna. We recommend using a sensitive multi-element antenna.
<b>AM radio reception is weak or noisy.</b>	The noises may be caused by fluorescent lamps, motors, thermostats, or other electrical equipment.	It is difficult to completely eliminate noise. It may be reduced by using an outdoor AM antenna.
<b>Radio stations cannot be selected automatically.</b>	Your area is too far from the FM station transmitter.	Select the station manually (p.84).
		Use an outdoor antenna. We recommend using a sensitive multi-element antenna.
	The AM radio signal is weak.	Adjust the AM antenna orientation.
		Select the station manually (p.84). Use an outdoor AM antenna. Connect it to the ANTENNA (AM) jack together with the supplied AM antenna.
<b>AM radio stations cannot be registered as presets.</b>	Auto Preset has been used.	Auto Preset is for registering FM radio stations. Register AM radio stations manually (p.84).

## DAB radio (Australia model only)

Problem	Cause	Remedy
<b>No DAB radio reception.</b>	An initial scan has not been performed.	Perform an initial scan to receive DAB radio (p.87).
<b>No DAB radio reception even after performing an initial scan.</b>	Reception strength of DAB radio is poor.	Check reception strength in "Tune AID" in the "Option" menu (p.90), and adjust the antenna height or orientation, or place it in a different location.
	There is no DAB coverage in your area.	Check with your dealer or WorldDMB online at " <a href="http://www.worlddab.org">http://www.worlddab.org</a> " for a listing of the DAB coverage in your area.
<b>DAB radio reception is weak or noisy.</b>	There is multi-path interference.	Check reception strength in "Tune AID" in the "Option" menu (p.90), and adjust the antenna height or orientation, or place it in a different location.
	Your area is too far from the DAB station transmitter.	Use an outdoor antenna. We recommend using a sensitive multi-element antenna.
<b>DAB information is not available or is inaccurate.</b>	The selected DAB radio station may be temporarily out of service or may not provide information.	Contact the DAB broadcaster.
<b>No DAB radio sound.</b>	The selected DAB radio station may be temporarily out of service.	Try the station later or select another station.

# Bluetooth

Problem	Cause	Remedy
<b>A Bluetooth connection cannot be established.</b>	The Bluetooth function of the unit is disabled.	Enable the Bluetooth function (p.152).
	Another Bluetooth device is already connected to the unit.	Terminate the current Bluetooth connection and then establish a new connection (p.95).
	The unit and the Bluetooth device are too far apart.	Move the Bluetooth device closer to the unit.
	There is a device (such as microwave oven and wireless LAN) that outputs signals in the 2.4 GHz frequency band nearby.	Move the unit away from those devices.
	The Bluetooth device does not support A2DP.	Use a Bluetooth device that supports A2DP.
	The connection information registered on the Bluetooth device is not working for some reason.	Delete the connection information on the Bluetooth device, and then establish a connection between the Bluetooth device and the unit again (p.95).
<b>No sound is produced, or the sound is interrupted during playback.</b>	The volume of the Bluetooth device is set too low.	Turn up the volume of the Bluetooth device.
	The Bluetooth device is not set to send audio signals to the unit.	Switch the audio output of the Bluetooth device to the unit.
	The Bluetooth connection has been terminated.	Establish a Bluetooth connection between the Bluetooth device and the unit again (p.95).
	The unit and the Bluetooth device are too far apart.	Move the Bluetooth device closer to the unit.
	There is a device (such as microwave oven and wireless LAN) that outputs signals in the 2.4 GHz frequency band nearby.	Move the unit away from those devices.

## USB and network

Problem	Cause	Remedy
<b>The unit does not detect the USB device.</b>	The USB device is not connected to the USB jack securely.	Turn off the unit, reconnect your USB device, and turn the unit on again.
	The file system of the USB device is not FAT16 or FAT32.	Use a USB device with FAT16 or FAT32 format.
<b>Folders and files in the USB device cannot be viewed.</b>	The data in the USB device is protected by the encryption.	Use a USB device without an encryption function.
<b>The files in the USB device cannot be played back continuously.</b>	Files not supported by the unit exist in the selected folder.	If the unit detects a series of unsupported files (such as images and hidden files) during playback, playback stops automatically. Do not store the unsupported files in the playback folder.
<b>The network feature does not function.</b>	The network parameters (IP address) have not been obtained properly.	Enable the DHCP server function on your router and set “DHCP” in the “Setup” menu to “On” on the unit (p.150). If you want to configure the network parameters manually, check that you are using an IP address which is not used by other network devices in your network (p.150).
<b>The unit cannot connect to the Internet via a wireless router (access point).</b>	The wireless router (access point) is turned off.	Turn on the wireless router.
	The unit and the wireless router (access point) are too far apart.	Place the unit and the wireless router (access point) closer to each other.
	There is an obstacle between the unit and the wireless router (access point).	Move the unit and the wireless router (access point) in a location where there are no obstacles between them.
<b>Wireless network is not found.</b>	Microwave ovens or other wireless devices in your neighborhood might disturb the wireless communication.	Turn off these devices.
	Access to the network is restricted by the firewall settings of the wireless router (access point).	Check the firewall setting of the wireless router (access point).
<b>The unit does not detect the PC.</b>	The media sharing setting is not correct.	Configure the sharing setting and select the unit as a device to which music contents are shared (p.101).
	Some security software installed on your PC is blocking the access of the unit to your PC.	Check the settings of security software installed on your PC.
	The unit and PC are not in the same network.	Check the network connections and your router settings, and then connect the unit and the PC to the same network.
	The MAC address filter is enabled on the unit.	In “MAC Address Filter” in the “Setup” menu, disable the MAC address filter or specify the MAC address of your PC to allow it to access to the unit (p.151).
<b>The files in the PC cannot be viewed or played back.</b>	The files are not supported by the unit or the media server.	Use the file format supported by both the unit and the media server. For information about the file formats supported by the unit, see “Playing back music stored on media servers (PCs/NAS)” (p.101).
<b>The files in the PC cannot be played back continuously.</b>	Files not supported by the unit exist in the selected folder.	If the unit detects a series of unsupported files (such as images and hidden files) during playback, playback stops automatically. Do not store the unsupported files in the playback folder.

Problem	Cause	Remedy
<b>The Internet radio cannot be played.</b>	The selected Internet radio station is currently not available.	There may be a network problem at the radio station, or the service may have been stopped. Try the station later or select another station.
	The selected Internet radio station is currently broadcasting silence.	Some Internet radio stations broadcast silence at certain of times of the day. Try the station later or select another station.
	Access to the network is restricted by the firewall settings of your network devices (such as the router).	Check the firewall settings of your network devices. The Internet radio can be played only when it passes through the port designated by each radio station. The port number varies depending on the radio station.
<b>The iPod does not recognize the unit when using AirPlay.</b>	The unit is connected to a multiple SSID router.	Access to the unit might be restricted by the network separation function on the router. Connect the iPod to the SSID which can access the unit.
<b>The application for smartphone/tablet “AV CONTROLLER” does not detect the unit.</b>	The unit and smartphone/tablet are not in the same network.	Check the network connections and your router settings, and then connect the unit and smartphone/tablet to the same network.
	The MAC address filter is enabled on the unit.	In “MAC Address Filter” in the “Setup” menu, disable the MAC address filter or specify the MAC address of your smartphone/tablet to allow it to access to the unit (p.151).
<b>No sound from the MusicCast compatible device.</b>	The MusicCast compatible device is turned off.	Turn on the MusicCast compatible device.
	The MusicCast compatible device is not connected to the MusicCast network.	Connect the device with “MusicCast CONTROLLER”.
<b>The MusicCast connection cannot be made on “MusicCast CONTROLLER”.</b>	The mobile device which “MusicCast CONTROLLER” is installed is not connected to the wireless network at your home.	Connect the mobile device to the wireless router and start “MusicCast CONTROLLER”. Disable the cellular data transmission.
	The MusicCast compatible device is turned off.	Turn on the MusicCast compatible device.
<b>“MusicCast CONTROLLER” does not detect a MusicCast compatible device.</b>	The mobile device which “MusicCast CONTROLLER” is installed is not connected to the wireless network at your home.	Connect the mobile device to the wireless router and set the MusicCast compatible device with “MusicCast CONTROLLER”.
	The MusicCast compatible device is turned off.	Turn on the MusicCast compatible device.
		Enable the network standby function on the MusicCast compatible device.
<b>Firmware update via the network is failed.</b>	It may not be possible depending on the condition of the network.	Update the firmware via the network again or use a USB memory device (p.165).

## Error indications on the front display

Message	Cause	Remedy
<b>Access denied</b>	Access to the PC is denied.	Configure the sharing settings and select the unit as a device to which music contents are shared (p.101).
<b>Access error</b>	The unit cannot access the USB device.	Turn off the unit and reconnect your USB device. If the problem persists, try another USB device.
	There is a problem with the signal path from the network to the unit.	Make sure your router and modem are turned on. Check the connection between the unit and your router (or hub) (p.50).
<b>Check SP Wires</b>	The speaker cables short circuit.	Twist the bare wires of the cables firmly and connect to the unit and speakers properly.
<b>Internal Error</b>	An internal error has occurred.	Contact the nearest authorized Yamaha dealer or service center.
<b>No content</b>	There are no playable files in the selected folder.	Select a folder that contains files supported by the unit.
<b>No device</b>	The unit cannot detect the USB device.	Turn off the unit and reconnect your USB device. If the problem persists, try another USB device.
<b>Please wait</b>	The unit is preparing for connecting to the network.	Wait until the message disappears. If the message stays more than 3 minutes, turn off the unit and turn it on again.
<b>RemID Mismatch</b>	The remote control IDs of the unit and the remote control are not identical.	Change the remote control ID of the unit or the remote control (p.163).
<b>Remote Off</b>	The unit cannot be operated from remote control because the remote control sensor on the main unit is turned off.	Use the controls on the front panel. To use the remote control, set "REMOTE SENSOR" in the "ADVANCED SETUP" menu to "ON" (p.162).
<b>Unable to play</b>	The unit cannot play back the songs stored on the USB device for some reasons.	Check the song data. If it cannot be played on another device, the song data may be defective.
	The unit cannot play back the songs stored on the PC for some reason.	Check if the format of files you are trying to play is supported by the unit. For information about the formats supported by the unit, see "Playing back music stored on media servers (PCs/NAS)" (p.101). If the unit supports the file format, but still cannot play back any files, the network may be overloaded with heavy traffic.
<b>Update failed.</b>	Firmware update is failed.	Update the firmware again.
<b>USB Overloaded</b>	An overcurrent is flowing through the USB device.	Turn off the unit and reconnect your USB device. If the problem persists, try another USB device.
<b>Version error</b>	Firmware update is failed.	Update the firmware again.

This section explains the technical terms used in this manual.

## Audio information (audio decoding format)

### Dolby Atmos

Introduced first in the cinema, Dolby Atmos brings a revolutionary sense of dimension and immersion to the Home Theater experience. Dolby Atmos is an adaptable and scalable object based format that reproduces audio as independent sounds (or objects) that can be accurately positioned and move dynamically throughout the 3 dimensional listening space during playback. A key ingredient of Dolby Atmos is the introduction of a height plane of sound above the listener.

### Dolby Atmos Stream

Dolby Atmos content will be delivered to your Dolby Atmos enabled AV receiver via Dolby Digital Plus or Dolby TrueHD on Blu-ray Disc, downloadable files and streaming media. A Dolby Atmos stream contains special metadata that describes the positioning of sounds within the room. This object audio data is decoded by a Dolby Atmos AV receiver and scaled for optimum playback through Home Theater speaker systems of every size and configuration.

### Dolby Digital

Dolby Digital is a compressed digital audio format developed by Dolby Laboratories, Inc. that supports 5.1-channel audio. This technology is used for audio on most DVD discs.

### Dolby Digital Plus

Dolby Digital Plus is a compressed digital audio format developed by Dolby Laboratories, Inc. that supports 7.1-channel audio. Dolby Digital Plus remains fully compatible with the existing multichannel audio systems that support Dolby Digital. This technology is used for audio on BD (Blu-ray discs).

### Dolby Enabled Speaker

A convenient alternative to speakers built into the ceiling, products utilizing Dolby speaker technology employ the ceiling above you as a reflective surface for reproducing audio in the height plane above the listener. Dolby enabled speakers feature a unique upward firing driver and special signal processing that can be built into a conventional speaker, or a standalone speaker module, minimally impacting the overall speaker system footprint while providing an immersive listening experience during Dolby Atmos and Dolby surround playback.

### Dolby Surround

Dolby surround is a next generation surround technology that intelligently up mixes stereo; 5.1 and 7.1 content for playback through your surround speaker system. Dolby surround is compatible with traditional speaker layouts, as well as Dolby Atmos enabled playback systems that employ in-ceiling speakers or products with Dolby speaker technology.

### Dolby TrueHD

Dolby TrueHD is an advanced lossless audio format developed by Dolby Laboratories, Inc. to offer a high-definition home theater experience with the quality of the studio master. Dolby TrueHD can carry up to eight channels of 96 kHz/24-bit audio (up to six channels of 192 kHz/24-bit audio) simultaneously. This technology is used for audio on BD (Blu-ray discs).

### DSD (Direct Stream Digital)

DSD (Direct Stream Digital) technology stores audio signals on digital storage media, such as SACD (Super Audio CDs). The signals are stored at a high-frequency sampling rate (such as 2.8224 MHz and 5.6448 MHz). The highest frequency response is equal to or higher than 100 kHz, with a dynamic range of 120 dB. This technology offers better audio quality than that used for CDs.

### DTS 96/24

DTS 96/24 is a compressed digital audio format that supports 5.1-channel and 96 kHz/24-bit audio. This format remains fully compatible with the existing multichannel audio systems that support DTS Digital Surround. This technology is used for music DVDs, etc.

### DTS Dialog Control

DTS Dialog Control allows you to boost the dialog. This can be useful in noisy environments to help make the dialog more intelligible. People with impaired hearing may also benefit. Note that the content creator may disable the use of this feature in the mix, so that DTS Dialog Control may not always be available. Note that updates to your AVR may add more functionality to DTS Dialog Control or increase the range of the feature.

### DTS Digital Surround

DTS Digital Surround is a compressed digital audio format developed by DTS, Inc. that supports 5.1-channel audio. This technology is used for audio on most DVD discs.

### DTS-ES

DTS-ES creates total 6.1-channel audio from 5.1-channel sources that are recorded with DTS-ES. This decoder adds a surround back sound to the original 5.1-channel sound. In the DTS-ES Matrix 6.1 format, a surround back sound is recorded in the surround channels, and in the DTS-ES Discrete 6.1 format, a discrete surround back channel is recorded.

### DTS Express

DTS Express is a compressed digital audio format that supports 5.1-channel audio and allows a higher compression rate than the DTS Digital Surround format developed by DTS, Inc. This technology is developed for audio streaming services on the Internet and secondary audio on BD (Blu-ray discs).

### DTS-HD High Resolution Audio

DTS-HD High Resolution Audio is a compressed digital audio format developed by DTS, Inc. that supports 7.1-channel and 96 kHz/24-bit audio. DTS-HD High Resolution Audio remains fully compatible with the existing multichannel audio systems that support DTS Digital Surround. This technology is used for audio on BD (Blu-ray discs).

### DTS-HD Master Audio

DTS-HD Master Audio is an advanced lossless audio format developed to offer a high-definition home theater experience with the quality of the studio master by DTS, Inc. DTS-HD Master Audio can carry up to eight channels of 96 kHz/24-bit audio (up to six channels of 192 kHz/24-bit audio) simultaneously. This technology is used for audio on BD (Blu-ray discs).

### **DTS Neo:6**

DTS Neo:6 enables 6-channel playback from 2-channel sources. There are two modes available: “Music mode” for music sources and “Cinema mode” for movie sources. This technology provides discrete full-bandwidth matrix channels of surround sound.

### **DTS:X**

DTS:X is the next generation object-based, multi-dimensional audio technology from DTS. Unbound from channels, DTS:X conveys the fluid movement of sound to create an incredibly rich, realistic and immersive soundscape - in front of, behind, beside and above the audience - more accurately than ever before. DTS:X offers the ability to automatically adapt the audio to the speaker layout that best fits the space, from a television’s built-in speakers to a home surround theater system to a dozen or more speakers in a commercial cinema. Immerse yourself at [www.dts.com/dtsx](http://www.dts.com/dtsx)

### **FLAC**

FLAC is a file format for lossless audio data compression. FLAC is inferior to lossy compressed audio formats in compression rate but provides higher audio quality.

### **MP3**

One of the compressed digital audio format used by MPEG. With psychoacoustic technologies, this compression method achieves a high compression rate. Reportedly, it is capable of compressing data quantity by about 1/10 maintaining a certain level of audio quality.

### **MPEG-4 AAC**

An MPEG-4 audio standard. It is used for mobile telephones, portable audio players, and audio streaming services on Internet because it allows a high compression rate of data while maintaining better audio quality than MP3.

### **Neural:X**

Neural:X is the latest downmixing/upmixing and spatial remapping technology from DTS. It is built in to DTS:X to provide upmix of Neural:X-encoded and non-encoded (PCM) data. In DTS:X for AVRs and Sound Bars, Neural:X can produce up to 11.x channels.

### **PCM (Pulse Code Modulation)**

PCM is a signal format under which an analog audio signal is digitized, recorded, and transmitted. This technology is the basis of all other audio format. This technology is used as a lossless audio format called Linear PCM for audio on a variety of media, including CDs and BD (Blu-ray discs).

### **Sampling frequency/Quantization bit**

Sampling frequency and quantization bits indicate the quantity of information when an analog audio signal is digitized. These values are noted as in the following example: “48 kHz/24-bit”.

- Sampling frequency

Sampling frequency (the number of times the signal is sampled per second) is called the sampling rate. When the sampling frequency is higher, the range of frequencies that can be played back are wider.

- Quantization bit

The number of quantization bits indicate the degree of accuracy when converting the sound level into a numeric value. When the number of quantized bits is higher, the expression of the sound level is more accurate.

### **WAV**

Windows standard audio file format, which defines the method of recording the digital data obtained by converting audio signals. By default, the PCM method (no compression) is used, but you can also use other compression methods.

### **WMA (Windows Media Audio)**

One of the compressed digital audio formats developed by Microsoft Corporation. With psychoacoustic technologies, this compression method achieves a high compression rate. Reportedly, it is capable of compressing data quantity by about 1/20 maintaining a certain level of audio quality.

## Audio Information (Others)

---

### Bi-amplification connection (Bi-amp)

A bi-amplification connection uses two amplifiers for a speaker. When you use the bi-amplification connection, the unit drives the tweeter and woofer in a speaker with the discrete amplifiers. As a consequence, the tweeter and woofer provide clear audio signal without the interference.

### LFE (Low Frequency Effects) 0.1 channel

This channel reproduces low-frequency bass signals and has a frequency range from 20 Hz to 120 Hz. This channel is added to the channels for all bands with Dolby Digital or DTS to enhance low frequency audio effects. This channel is labeled 0.1 because it is limited to only low frequency audio.

### Lip sync

Video output sometimes lags behind audio output due to the complexity of signal processing caused by an increase in video signal capacity. Lip sync is a technique for automatically correcting the timing lag between audio and video output.

## HDMI and video information

---

### Component video signal

With the component video signal system, the video signal is separated into the Y signal for luminance and the Pb and Pr signals for chrominance. Color can be reproduced more faithfully with this system because each of these signals is independent.

### Composite video signal

With the composite video signal system, color, brightness, and synchronization data signals are combined and transmitted with a single cable.

### Deep Color

Deep Color is a technology that HDMI specification supports. Deep Color increases the number of available colors within the boundaries defined by the RGB or YCbCr color space. Conventional color systems process the color using 8 bits. Deep Color processes the color with 10, 12, or 16 bits. This technology allows HDTVs and other displays to increase from millions of colors to billions of colors and eliminate on-screen color banding for smooth tonal transitions and subtle gradations between colors.

### HDCP

HDCP (High-bandwidth Digital Content Protection) is a digital copy protection form that prevents copying of digital contents as it travels across connections (such as HDMI).

### HDMI

HDMI (High-Definition Multimedia Interface) is the world-wide standard interface for digital audio/video signal transmission. This interface transmits both digital audio and digital video signals using a single cable without any loss. HDMI complies with HDCP (High-bandwidth Digital Content Protection) and provides a secure audio/video interface. For further information on HDMI, visit the HDMI website at "<http://www.hdmi.org/>".

### x.v.Color

"x.v.Color" is a technology that the HDMI specification supports. It is a more extensive color space than sRGB and allows the expression of colors that were not hitherto possible. While remaining compatible with the color gamut of sRGB standards, "x.v.Color" expands the color space, and thus can produce more vivid, natural images.



## Network information

---

### SSID

SSID (Service Set Identifier) is a name that identifies a particular wireless LAN access point.

### Wi-Fi

Wi-Fi (Wireless Fidelity) is a technology that allows an electronic device to exchange data or connect to the Internet wirelessly using radio waves. Wi-Fi offers the advantage of eliminating the complexity of making connections with network cables by using wireless connection. Only products that complete Wi-Fi Alliance interoperability tests can carry the “Wi-Fi Certified” trademark.

### WPS

WPS (Wi-Fi Protected Setup) is a standard established by the Wi-Fi Alliance, which allows easy establishment of a wireless home network.

## Yamaha technologies

---

### CINEMA DSP (Digital Sound Field Processor)

Since the surround sound systems were originally designed for use in movie theaters, their effect is best experienced in a theater that has many speakers designed for acoustic effects. Since home conditions (such as room size, wall material, and number of speakers) can differ so widely, it is inevitable that there are differences in the sound that you hear. Based on a wealth of actually measured data, CINEMA DSP, Yamaha’s original DSP technology provides the audiovisual experience of a movie theater in your own home.

### CINEMA DSP HD<sup>3</sup>

The actually measured sound field data contain the information of the height of the sound images. CINEMA DSP HD<sup>3</sup> feature achieves the reproduction of the accurate height of the sound images so that it creates the accurate and intensive stereoscopic sound fields in a listening room.

### Compressed Music Enhancer

The Compressed Music Enhancer feature compensates for missing harmonics in compression music formats (such as MP3). As a result, this technology provides improved performance for the overall sound system.

### SILENT CINEMA

Yamaha has developed a natural, realistic sound effect DSP algorithm for headphones. Parameters for headphones have been set for each sound program, so that accurate representations of all the sound programs can be enjoyed on headphones.

### Virtual CINEMA DSP

Virtual CINEMA DSP allows the system to virtually reproduce the sound field of the surround speakers with front left and right speakers. Even if the surround speakers are not connected, the unit creates the realistic sound field in a listening room.

### Virtual CINEMA FRONT

Virtual CINEMA FRONT allows the system to virtually reproduce the sound field of the surround speakers with front surround speakers. Even if the surround speakers placed in the front, the unit creates the realistic sound field in a listening room.

### Virtual Presence Speaker (VPS)

Virtual Presence Speaker allows the system to virtually reproduce the height of the 3D sound field without presence speakers. Even if the presence speakers are not connected, the unit creates the 3D sound field in your room.

### Virtual Surround Back Speaker (VSBS)

Virtual Surround Back Speaker allows the system to virtually reproduce the sound field of the surround back speakers. Even if the surround back speakers are not connected, the unit adds a sense of depth to the rear sound field of CINEMA DSP.

## Supported devices and file formats

This section explains the devices and file formats supported by the unit.

### Supported devices

For information about specifications of each device, refer to the instruction manual of it.

#### Bluetooth device

- The unit supports Bluetooth devices that support A2DP or AVRCP.
- A Bluetooth device may not be detected by the unit or some feature may not be compatible, depending on the model.

#### USB devices

- The unit supports USB mass storage class devices (e.g., flash memories or portable audio players) using FAT16 or FAT32 format.
- Do not connect devices other than USB mass storage class devices (such as USB chargers or USB hubs), PCs, card readers, an external HDD, etc.
- USB devices with encryption cannot be used.
- Some features may not be compatible, depending on the model or manufacturer of the USB storage device.

#### AirPlay

AirPlay works with iPhone, iPad, and iPod touch with iOS 4.3.3 or later, Mac with OS X Mountain Lion or later, and PC with iTunes 10.2.2 or later.

Made for.

iPhone 7 Plus, iPhone 7, iPhone SE, iPhone 6s Plus, iPhone 6s, iPhone 6 Plus, iPhone 6, iPhone 5s, iPhone 5c, iPhone 5, iPhone 4s

iPad Pro (9.7" and 12.9"), iPad mini 4, iPad Air 2, iPad mini 3, iPad Air, iPad mini 2, iPad mini, iPad (3rd and 4th generation), iPad 2

iPod touch (5th and 6th generation)

(as of May 2017)

## File formats

For information about specifications of each file, refer to the instruction manual of your recording device or consult file's help.

### USB/PC (NAS)

File	Sampling frequency (kHz)	Quantization bitrate (bit)	Bitrate	The number of channels	Gapless playback
WAV *	32/44.1/48/88.2/96/176.4/192	16/24	—	2	✓
MP3	32/44.1/48	—	8 to 320	2	—
WMA	32/44.1/48	—	8 to 320	2	—
MPEG-4 AAC	32/44.1/48	—	8 to 320	2	—
FLAC	32/44.1/48/88.2/96/176.4/192	16/24	—	2	✓
ALAC	32/44.1/48/88.2/96	16/24	—	2	✓
AIFF	32/44.1/48/88.2/96/176.4/192	16/24	—	2	✓
DSD	2.8 MHz/5.6 MHz	1	—	2	—

\* Linear PCM format only



- To play back FLAC files stored on a PC or NAS, you need to install server software that supports sharing of FLAC files via DLNA on your PC or use a NAS that supports FLAC files.
- Digital Rights Management (DRM) contents cannot be played back.

## Video signal flow

Video signals input from a video device to the unit are output to a TV as shown below.

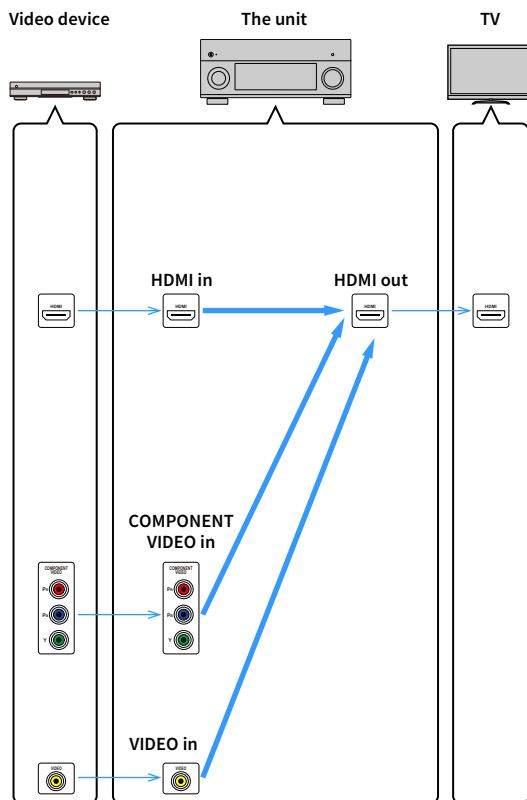

## Video conversion table



- You can select the resolution and the aspect ratio applied to HDMI-output video processing in “Video Mode” (p.147) in the “Setup” menu.
- The unit does not convert 480-line and 576-line video signals interchangeably.

		HDMI out					
		Resolution	480i/576i	480p/576p	720p	1080i	1080p
HDMI in	480i/576i	→	→	→	→	→	→
	480p/576p		→	→	→	→	→
	720p			→	→	→	→
	1080i			→	→	→	→
	1080p/50, 60 Hz			→	→	→	→
	1080p/24 Hz					→	→
	4K						→
COMPONENT VIDEO in	480i/576i	→	→	→	→	→	→
	480p/576p		→	→	→	→	→
	720p			→	→	→	→
	1080i			→	→	→	→
VIDEO in	480i/576i	→	→	→	→	→	→

→ : Available

## Multi-zone output

Audio signals that can be output to Zone2, Zone3 and Zone4 vary depending on how you connect the device in each zone to the unit's output jacks.

In \ Out	Using the unit's internal amplifier (p.39)		Using an external amplifier (p.111)			
	EXTRA SP 1-2 jacks		ZONE OUT jacks		HDMI OUT 2 (ZONE OUT) jack	
	Zone2	Zone3	Zone2	Zone3	Zone2 (*1)	Zone4 (*2)
Digital audio (HDMI)	→ (*3)		→ (*3)		→ (*4)	→ (*5)
Digital audio (COAXIAL/OPTICAL)	→ (*6)	→ (*6)	→ (*6)	→ (*6)	→ (*6)	
Analog audio (AUDIO)	→	→	→	→	→	
USB (*7)	→	→	→	→	→	
Network sources (*7)	→	→	→	→	→	
TUNER	→	→	→	→	→	

→: Available

\*1 Available when "HDMI OUT2 Assign" (p.155) in the "Setup" menu is set to "Zone2" (Zone2 - Audio Output: On)

\*2 Available when "HDMI OUT2 Assign" (p.155) in the "Setup" menu is set to "Zone4"

\*3 Available when 2-channel PCM signals are input (stereo output [down mixed to 2-channels] when the input source selected in the main zone is selected)

Available when "HDMI OUT2 Assign" (p.155) in the "Setup" menu is set to "Zone2"

\*4 Available when 2-channel PCM signals are input (stereo output [down mixed to 2-channels] when the input source selected in the main zone is selected)

\*5 HDMI audio pass-through (stereo output [down mixed to 2-channels] when the input source selected in the main zone is selected)

\*6 Available when 2-channel PCM signals are input

\*7 To play back DSD audio in Zone2/Zone3, select "Main Zone Sync" as the Zone2/Zone3 input with the web control (p.117) or use the party mode (p.115).

## Information on HDMI

This section explains the functions related to HDMI and its signal compatibility.

### HDMI Control

HDMI Control allows you to operate external devices via HDMI. If you connect a TV that supports HDMI Control to the unit with an HDMI cable, you can control the unit (such as power and volume) with TV remote control operations. You can also control playback devices (such as HDMI Control-compatible BD/DVD players) connected to the unit with an HDMI cable.

For details on connections, see "Connecting a TV and playback devices" (p.41) and "Connecting video devices (such as BD/DVD players)" (p.44).

#### Operations available from the TV's remote control

- Standby synchronization
- Volume control including mute
- Switching to input audio from the TV when the TV input is switched to its built-in tuner
- Switching to input video/audio from the selected playback device
- Switching between audio output devices (the unit or TV speaker)

#### (Example)

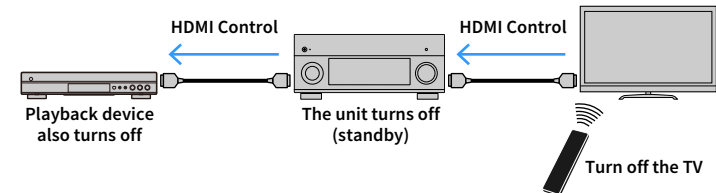

#### Operations available from the unit's remote control

- Starting playback on the playback device and turning on the TV with a scene selection (p.76)
- Switching the TV input to display the on-screen menu (when ON SCREEN is pressed)
- Controlling the playback device (playback and menu operations) without registering remote control codes (p.167)

**(Example)**

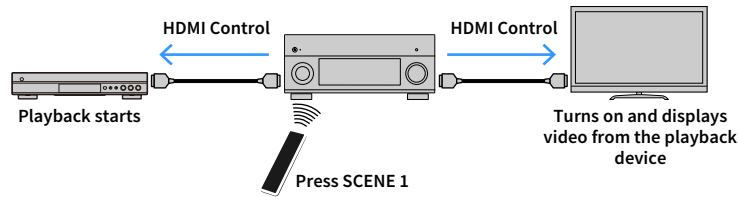

To use HDMI Control, you need to perform the following HDMI Control link setup after connecting the TV and playback devices.

For details on settings and operating your TV, refer to the instruction manual for the TV.



This setup is required every time you add a new HDMI Control-compatible device to your system.

**1** Turn on the unit, TV, and playback devices.

**2** Configure the settings of the unit.

**1** Switch the TV input to display video from the unit.

**2** Press ON SCREEN.

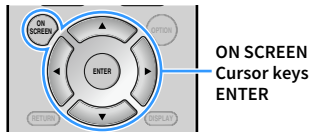

**3** Use the cursor keys to select “Setup” and press ENTER.

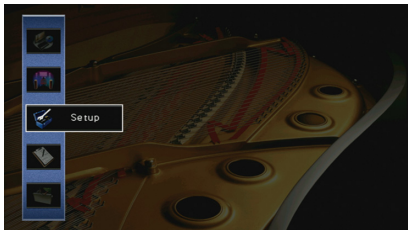

**4** Use the cursor keys (◀/▶) to select “HDMI”.



**5** Use the cursor keys (▲/▼) to select “HDMI Control” and press ENTER.

**6** Use the cursor keys to select “On”.

**7** Press ON SCREEN.

**3** Enable HDMI Control on the TV and playback devices (such as HDMI Control-compatible BD/DVD players).

**4** Turn off the main power of the TV and then turn off the unit and playback devices.

**5** Turn on the unit and playback devices and then turn on the TV.

**6** Check the followings.

On the unit: The input to which the playback device is connected is selected. If not, select the input source manually.

On the TV: The video from the playback device is displayed.

**7** Switch the TV input to display the video from the unit.

**8** Check that the unit is properly synchronized with the TV by turning off the TV or adjusting the TV volume with the TV remote control.



- If HDMI Control does not work properly, try unplugging the TV in Step 3 and plugging in the TV again in Step 4. It may solve the problem. Also, HDMI Control may not work if the number of connected devices exceeds the limit. In this case, disable HDMI Control on the devices not in use.
- If the unit is not synchronized to the TV's power operations, check the priority of the audio output setting on the TV.
- We recommend using TV and playback devices from the same manufacturer so that HDMI Control works more effectively.
- We do not assure the operation of all HDMI Control-compatible devices.

## Audio Return Channel (ARC)

ARC allows you to input TV audio to the unit with the HDMI cable which transmits video signal to the TV.

Check the following after the HDMI Control settings.

- 1** Select a TV program with the TV remote control.
- 2** Check that the input source of the unit will be automatically switched to “AUDIO 1” and the TV audio will be played back on the unit.

If you cannot hear the TV audio, check the following:

- “ARC” (p.149) in the “Setup” menu is set to “On”.
- The HDMI cable is connected to the ARC-compatible HDMI jack (HDMI jack marked “ARC”) on the TV.

Some HDMI jack on the TV is not compatible with ARC. For details, refer to the instruction manual for the TV.



- If the audio is interrupted while using ARC, set “ARC” (p.149) in the “Setup” menu to “Off” and use an audio cable (digital optical or stereo pin cable) to input TV audio to the unit (p.43).
- When using ARC, connect a TV with an HDMI cable that supports ARC.



“AUDIO 1” is set as TV audio input at the factory. If you have connected any external device to the AUDIO 1 jacks, use “TV Audio Input” (p.149) in the “Setup” menu to change the TV audio input assignment. To use the SCENE function (p.77), you also need to change the input assignment for SCENE 2.

## HDMI signal compatibility

- When CPPM copy-protected DVD-Audio is played back, video/audio signals may not be output, depending on the type of the DVD player.
- The unit is not compatible with HDCP-incompatible HDMI or DVI devices. For details, refer to the instruction manual for each device.
- To decode audio bitstream signals on the unit, set the input source device appropriately so that the device outputs the bitstream audio signals directly (does not decode the bitstream signals on the playback device). For details, refer to the instruction manual for the playback device.

## DOLBY ATMOS®

Manufactured under license from Dolby Laboratories. Dolby, Dolby Atmos, Dolby Surround, and the double-D symbol are trademarks of Dolby Laboratories.



For DTS patents, see <http://patents.dts.com>. Manufactured under license from DTS, Inc. DTS, the Symbol, DTS in combination with the Symbol, DTS:X, and the DTS:X logo are registered trademarks or trademarks of DTS, Inc. in the United States and/or other countries. © DTS, Inc. All Rights Reserved.



Supports iOS 7 or later for setup using Wireless Accessory Configuration.

“Made for iPod,” “Made for iPhone,” and “Made for iPad” mean that an electronic accessory has been designed to connect specifically to iPod, iPhone, or iPad, respectively, and has been certified by the developer to meet Apple performance standards.

Apple is not responsible for the operation of this device or its compliance with safety and regulatory standards.

Please note that the use of this accessory with iPod, iPhone, or iPad may affect wireless performance.

iTunes, AirPlay, iPad, iPhone, iPod, iPod touch, and Apple TV are trademarks of Apple Inc., registered in the U.S. and other countries.

iPad Air and iPad mini are trademarks of Apple Inc.

App Store is a service mark of Apple Inc.



The Bluetooth® word mark and logos are registered trademarks owned by Bluetooth SIG, Inc. and any use of such marks by Yamaha Corporation is under license.

## Bluetooth protocol stack (Blue SDK)

Copyright 1999-2014 OpenSynergy GmbH

All rights reserved. All unpublished rights reserved.



(Australia model)

The unit supports DAB/DAB+ tuning.



The terms HDMI, the HDMI Logo, and High-Definition Multimedia Interface are trademarks or registered trademarks of HDMI Licensing LLC in the United States and other countries.

## x.v.Color™

“x.v.Color” is a trademark of Sony Corporation.



DLNA™ and DLNA CERTIFIED™ are trademarks or registered trademarks of Digital Living Network Alliance. All rights reserved. Unauthorized use is strictly prohibited.

## Windows™

Windows is a registered trademark of Microsoft Corporation in the United States and other countries.

Internet Explorer, Windows Media Audio and Windows Media Player are either registered trademarks or trademarks of Microsoft Corporation in the United States and/or other countries.

## Android™ Google Play™

Android and Google Play are trademarks of Google Inc.

Blu-ray is a trademark of the Blu-ray Disc Association.



The Wi-Fi CERTIFIED™ Logo is a certification mark of Wi-Fi Alliance®.

The Wi-Fi Protected Setup™ Identifier Mark is a certification mark of Wi-Fi Alliance®.



MusicCast is a trademark or registered trademark of Yamaha Corporation.



Yamaha Eco-Label is a mark that certifies products of high environmental performance.



“SILENT CINEMA” is a trademark of Yamaha Corporation.

## Google Noto Fonts (Version 1.001)

Copyright © 2012 Google Inc. All rights reserved.

Licensed under the Apache License, Version 2.0 (the “License”); you may not use this file except in compliance with the License.

You may obtain a copy of the License at <http://www.apache.org/licenses/LICENSE-2.0>

Unless required by applicable law or agreed to in writing, software distributed under the License is distributed on an “AS IS” BASIS, WITHOUT WARRANTIES OR CONDITIONS OF ANY KIND, either express or implied.

See the License for the specific language governing permissions and limitations under the License.

### Explanations regarding GPL

This product utilizes GPL/LGPL open-source software in some sections. You have the right to obtain, duplicate, modify, and redistribute this open-source code only. For information on GPL/LGPL open source software, how to obtain it, and the GPL/LGPL license, refer to the Yamaha Corporation website (<http://download.yamaha.com/sourcecodes/musiccast/>).

## Input jacks

- Analog Audio  
[RX-V3083]
  - Audio (Unbalance) x 9 (AV 1-4, AUDIO 1-3, PHONO, VIDEO AUX)
  - Audio (Balance) x 1 (AUDIO 4) (1:GHD, 2:HOT, 3:COLD)
- [RX-V2083]
  - Audio (Unbalance) x 9 (AV 1-4, AUDIO 1-3, PHONO, VIDEO AUX)
- Digital Audio
  - Optical x 3 (AV 3, AUDIO 1-2)  
(Supported sampling frequencies: 32 kHz to 96 kHz)
  - Coaxial x 3 (AV 1-2, AUDIO 3)  
(Supported sampling frequencies: 32 kHz to 192 kHz)
- Video
  - Composite x 4 (AV 1-4)
  - Component x 2 (AV 1-2)
- HDMI Input
  - HDMI x 8 (AV 1-7, VIDEO AUX)
- Others
  - USB x 1 (USB2.0)
  - NETWORK x 1 (100Base-TX/10Base-T)

## Output jacks

- Analog Audio
  - Speaker Out x 11 (9 ch) (FRONT L/R, CENTER, SURROUND L/R, SURROUND BACK L/R, EXTRA SP 1 L/R \*1, EXTRA SP 2 L/R \*2)
    - \*1 Note: Assignment is possible  
[F.PRESENCE, ZONE2, ZONE3, BI-AMP (FRONT L/R)]
    - \*2 Note: Assignment is possible  
[R.PRESENCE, ZONE2, ZONE3, F.PRESENCE]
  - Subwoofer Out x 2  
(SUBWOOFER 1-2, Stereo/Front&Rear/Monox2)
  - Headphone x 1
- [RX-V3083]
  - Pre Out x 11 (FRONT L/R, CENTER, SURROUND L/R, SURROUND BACK L/R, F.PRESENCE L/R \*3, R.PRESENCE L/R \*4)
    - \*3 Note: barter to ZONE2
    - \*4 Note: barter to ZONE3

- [RX-V2083]
  - Pre Out x 7 (FRONT L/R, CENTER, SURROUND L/R, SURROUND BACK L/R)
  - ZONE OUT x 2 (ZONE2/ZONE3)
- HDMI Output
  - HDMI OUT x 2 (HDMI OUT 1-2 \*5)
    - \*5 barter to ZONE OUT (ZONE2/ZONE4)

## Other jacks

- YPAO MIC x 1
- REMOTE IN x 1
- REMOTE OUT x 1
- TRIGGER OUT x 2
- RS-232C x 1

## HDMI

- HDMI Features
  - 4K UltraHD Video (include 4K/60,50Hz 10/12bit)
  - 3D Video
  - ARC (Audio Return Channel)
  - HDMI Control (CEC)
  - Auto Lip Sync
  - 21:9 Aspect Ratio
  - Deep Color
  - x.v.Color
  - BT.2020 Colorimetry
  - HDR (High Dynamic Range)
  - HD audio playback
  - Selectable HDMI input in HDMI standby mode
  - HDMI Zone Output

- Video Format (Repeater Mode)
  - VGA
  - 480i/60 Hz
  - 576i/50 Hz
  - 480p/60 Hz
  - 576p/50 Hz
  - 720p/60 Hz, 50 Hz
  - 1080i/60 Hz, 50 Hz
  - 1080p/60 Hz, 50 Hz, 30 Hz, 25 Hz, 24 Hz
  - 4K/60 Hz, 50Hz, 30 Hz, 25 Hz, 24 Hz
- Supported Audio Formats
  - Dolby Atmos
  - DTS:X
  - Dolby TrueHD
  - Dolby Digital Plus
  - Dolby Digital
  - DTS-HD Master Audio
  - DTS-HD High Resolution
  - DTS Express
  - DTS
  - DSD 2.8 MHz 2-ch to 6-ch
  - PCM 2-ch to 8-ch (Max. 192 kHz/24 bit)
- Content Protection: HDCP compatible  
(HDMI [AV 1-7]: HDCP 2.2 compatible)

## TUNER

- Analog Tuner
  - [Australia model]  
DAB/FM x 1 (TUNER)
  - [China model]  
FM/AM x 1 (TUNER)

## USB

- Capable of Mass Storage Class USB Memory
- Current Supply Capacity: 1 A



## Bluetooth

- Sink Function
  - Source Device to AVR (ex. Smartphone/Tablet)
- Source Function
  - AVR to Sink Device (ex. Bluetooth Headphone)
- Capable of Play/Stop Operation from Sink Device
- Bluetooth Version ..... Ver. 2.1+EDR
- Supported Profile
  - Sink Function ..... A2DP, AVRCP
  - Source Function ..... A2DP, AVRCP
- Supported Codec
  - Sink Function ..... SBC, AAC
  - Source Function ..... SBC
- Wireless Output ..... Bluetooth Class 2
- Radio Frequency (Operational Frequency) ... 2402 MHz to 2480 MHz
- Maximum Output Power (E.I.R.P) ..... 4.0 dBm (2.5 mW)
- Maximum Communication Distance ..... 10 m (33 ft)

## MusicCast

- Controlled by MusicCast Application (iOS, Android)
- MusicCast Link Client ..... Main, Zone2, Zone3
- MusicCast Link Master (Input Source) ..... NET/USB/Bluetooth, Analog External Input, Digital External Input, Zone2
- Network Connectivity ..... Extend Mode, Connect

## Network

- PC Client Function
- Compatible with DLNA ver. 1.5
- AirPlay supported
- Internet Radio
- Wi-Fi function
  - Capable of WPS by PIN Method and Push-Button-Method
  - Capable of sharing with iOS devices by wireless connection and USB connection
  - Capable of Direct Connection with Mobile Device
  - Available Security Method: WEP, WPA2-PSK (AES), Mixed Mode
  - Radio Frequency Band: 2.4 GHz
  - Wireless LAN Standards: IEEE 802.11 b/g/n
  - Radio Frequency (Operational Frequency): 2412 MHz to 2472 MHz
  - Maximum Output Power (E.I.R.P): 17.5 dBm (56.2 mW)

## Compatible Decoding Formats

- Decoding Format
  - Dolby Atmos
  - Dolby TrueHD, Dolby Digital Plus
  - Dolby Digital
  - DTS:X
  - DTS-HD Master Audio, DTS-HD High Resolution Audio, DTS Express
  - DTS 96/24, DTS-ES Matrix 6.1, DTS-ES Discrete 6.1
  - DTS Digital Surround
- Post Decoding Format
  - Dolby Surround
  - Neural:X
  - DTS Neo:6 Music, DTS Neo:6 Cinema

## Audio Section

- Rated Output Power (2-channel driven)

[RX-V3083]

(20 Hz to 20 kHz, 0.06% THD, 6 Ω)

Front L/R ..... 165 W+165 W

Center ..... 165 W

Surround L/R ..... 165 W+165 W

Surround Back L/R ..... 165 W+165 W

Front Presence L/R ..... 165 W+165 W

(20 Hz to 20 kHz, 0.06% THD, 8 Ω)

Front L/R ..... 150 W+150 W

Center ..... 150 W

Surround L/R ..... 150 W+150 W

Surround Back L/R ..... 150 W+150 W

Front Presence L/R ..... 150 W+150 W

(1 kHz, 0.9% THD, 8 Ω)

Front L/R ..... 165 W+165 W

Center ..... 165 W

Surround L/R ..... 165 W+165 W

Surround Back L/R ..... 165 W+165 W

Front Presence L/R ..... 165 W+165 W

[RX-V2083]

(20 Hz to 20 kHz, 0.06% THD, 6 Ω)

Front L/R ..... 150 W+150 W

Center ..... 150 W

Surround L/R ..... 150 W+150 W

Surround Back L/R ..... 150 W+150 W

Front Presence L/R ..... 150 W+150 W

(20 Hz to 20 kHz, 0.06% THD, 8 Ω)

Front L/R ..... 140 W+140 W

Center ..... 140 W

Surround L/R ..... 140 W+140 W

Surround Back L/R ..... 140 W+140 W

Front Presence L/R ..... 140 W+140 W

(1 kHz, 0.9% THD, 8 Ω)	
Front L/R .....	155 W+155 W
Center .....	155 W
Surround L/R .....	155 W+155 W
Surround Back L/R .....	155 W+155 W
Front Presence L/R .....	155 W+155 W

• Rated Output Power (1-channel driven)

[RX-V3083]

(1 kHz, 0.9% THD, 6 Ω)

Front L/R .....	200 W/ch
Center .....	200 W/ch
Surround L/R .....	200 W/ch
Surround Back L/R .....	200 W/ch
Front Presence L/R .....	200 W/ch

(1 kHz, 0.9% THD, 8 Ω)

Front L/R .....	185 W/ch
Center .....	185 W/ch
Surround L/R .....	185 W/ch
Surround Back L/R .....	185 W/ch
Front Presence L/R .....	185 W/ch

[RX-V2083]

(1 kHz, 0.9% THD, 6 Ω)

Front L/R .....	190 W/ch
Center .....	190 W/ch
Surround L/R .....	190 W/ch
Surround Back L/R .....	190 W/ch
Front Presence L/R .....	190 W/ch

(1 kHz, 0.9% THD, 8 Ω)

Front L/R .....	175 W/ch
Center .....	175 W/ch
Surround L/R .....	175 W/ch
Surround Back L/R .....	175 W/ch
Front Presence L/R .....	175 W/ch

• Maximum Effective Output Power (1-channel driven)

[RX-V3083]

(1 kHz, 10% THD, 6 Ω)

Front L/R .....	230 W/ch
Center .....	230 W/ch
Surround L/R .....	230 W/ch
Surround Back L/R .....	230 W/ch
Front Presence L/R .....	230 W/ch

(1 kHz, 10% THD, 8 Ω)

Front L/R .....	230 W/ch
Center .....	230 W/ch
Surround L/R .....	230 W/ch
Surround Back L/R .....	230 W/ch
Front Presence L/R .....	230 W/ch

[RX-V2083]

(1 kHz, 10% THD, 6 Ω)

Front L/R .....	220 W/ch
Center .....	220 W/ch
Surround L/R .....	220 W/ch
Surround Back L/R .....	220 W/ch
Front Presence L/R .....	220 W/ch

(1 kHz, 10% THD, 8 Ω)

Front L/R .....	220 W/ch
Center .....	220 W/ch
Surround L/R .....	220 W/ch
Surround Back L/R .....	220 W/ch
Front Presence L/R .....	220 W/ch

• Dynamic Power (IHF)

[RX-V3083]

Front L/R (8/6/4/2 Ω) ..... 175/220/295/410 W

[RX-V2083]

Front L/R (8/6/4/2 Ω) ..... 165/210/285/405 W

• Damping Factor

Front L/R, 1 kHz, 8 Ω ..... 150 or more

• Input Sensitivity / Input Impedance

PHONO (1 kHz, 100 W/8 Ω) ..... 3.5 mV/47 kΩ

AUDIO 2 etc. (1 kHz, 100 W/8 Ω) ..... 200 mV/47 kΩ

• Maximum Input Signal

PHONO (1 kHz, 0.5% THD) ..... 45 mV or more

AUDIO 2 etc. (1 kHz, 0.5% THD) ..... 2.4 V or more

• Rated Output Level / Output Impedance

PRE OUT

SUBWOOFER (50 Hz) ..... 1.0 V/470 Ω

Except SUBWOOFER (1 kHz) ..... 1.0 V/470 Ω

ZONE OUT ..... 1.0 V/470 Ω

• Maximum Output Level

PRE OUT/ZONE OUT ..... 2.0 V or more

• Headphone Impedance

..... 16 Ω or more

• Frequency Response

AUDIO 2 etc. (10 Hz to 100 kHz) ..... +0/-3 dB

• RIAA Equalization Deviation

PHONO (20 Hz to 20 kHz) ..... 0±0.5 dB

• Total Harmonic Distortion

[RX-V3083]

PHONO to PreOut (1 kHz, 1 V) ..... 0.04% or less

AUDIO 2 etc. to Speaker Out (20 Hz to 20 kHz, 75 W/ 8 Ω)

..... 0.04% or less

[RX-V2083]

PHONO to PreOut (1 kHz, 1 V) ..... 0.04% or less

AUDIO 2 etc. to Speaker Out (20 Hz to 20 kHz, 70 W/ 8 Ω)

..... 0.04% or less

• Signal to Noise Ratio (IHF-A Network)

(Pure Direct, Input 1 kΩ Shorted, Speaker Out)

PHONO ..... 95 dB or more

AUDIO 2 etc. .... 110 dB or more

• Residual Noise (IHF-A Network)

Speaker Out ..... 150 μV or less

• Channel Separation

(Input 1 kΩ Shorted, 1 kHz/10 kHz)

PHONO ..... 75 dB/60 dB or more

AUDIO 2 etc. .... 75 dB/60 dB or more

• Volume Control

Main Zone ..... MUTE, -80 dB to +16.5 dB (0.5 dB Step)

Zone2/Zone3 ..... MUTE, -80 dB to +16.5 dB (0.5 dB Step)

- Tone Control Characteristics

Main Zone

- Bass Boost/Cut ..... ±6.0 dB/50 Hz (0.5 dB Step)
- Bass Turnover..... 350 Hz
- Treble Boost/Cut..... ±6.0 dB/20 kHz (0.5 dB Step)
- Treble Turnover..... 3.5 kHz

Zone2/Zone3

- Bass Boost/Cut ..... ±6.0 dB/50 Hz (0.5 dB Step)
- Bass Turnover..... 350 Hz
- Treble Boost/Cut..... ±6.0 dB/20 kHz (0.5 dB Step)
- Treble Turnover..... 3.5 kHz

- Filter Characteristics

(fc=40/60/80/90/100/110/120/160/200 Hz)

H.P.F. (Front, Center, Surround, Surround Back: Small)

..... 12 dB/oct.

L.P.F. (Subwoofer) ..... 24 dB/oct.

## Video Section

- Video Signal Type ..... NTSC/PAL/SECAM

- Video Signal Level

Composite..... 1 Vp-p/75 Ω

Component

Y..... 1 Vp-p/75 Ω

Pb/Pr..... 0.7 Vp-p/75 Ω

- Video Maximum Input Level..... 1.5 Vp-p or more

## FM Section

- Tuning Range..... 87.50 MHz to 108.00 MHz

- 50 dB Quiet Sensitivity (IHF, 1 kHz, 100% MOD.)

Mono .....3 μV (20.8 dBf)

- Signal to Noise Ratio (IHF)

Mono/Stereo ..... 69 dB/68 dB

- Harmonic Distortion (IHF, 1 kHz)

Mono/Stereo ..... 0.5%/0.6%

- Antenna Input..... 75 Ω unbalanced

## AM section (China model)

- Tuning Range..... 531 kHz to 1611 kHz

## DAB section (Australia model)

- Tuning Range ..... 174 MHz to 240 MHz (Band III)

- Support Audio Format ..... MPEG 1 Layer II/MPEG-4 HE-AAC v2

- Antenna ..... 75 Ω unbalanced

## General

- Power Supply

[China model]..... AC 220 V, 50 Hz

[Australia model] ..... AC 240 V, 50 Hz

- Power Consumption ..... 490 W

- Standby Power Consumption

HDMI Control Off, Standby Through Off, Network Standby Off  
..... 0.1 W

HDMI Control On, Standby Through On (No Signals),  
Network Standby Off ..... 1.5 W

HDMI Control Off, Standby Through Off, Network Standby On,  
Bluetooth Standby Off

Wired ..... 1.8 W

Wireless (Wi-Fi) ..... 1.8 W

Wireless Direct ..... 1.9 W

HDMI Control Off, Standby Through Off,  
Network Standby On (Wired), Bluetooth Standby On ..... 1.7 W

HDMI Control On, Standby Through On, Network Standby On  
(Wireless Direct), Bluetooth Standby On ..... 2.7 W

- Dimensions (W x H x D)

.....435 x 192 x 474 mm (17-1/8" x 7-1/2" x 18-5/8")

\* Including legs and protrusions

- Reference Dimensions (W x H x D) (with wireless antenna upright)

..... 435 x 247 x 474 mm (17-1/8" x 9-3/4" x 18-5/8")

\* Including legs and protrusion

- Weight

[RX-V3083]

[China model] ..... 19.6 kg (43.2 lbs)

[Australia model] ..... 18.1 kg (39.9 lbs)

[RX-V2083] ..... 17.0 kg (37.5 lbs)

\* The contents of this manual apply to the latest specifications as of the publishing date. To obtain the latest manual, access the Yamaha website then download the manual file.

## List of remote control codes

### TV

A.R. Systems	0320	Asuka	0277, 0282, 0337, 0340, 0342	Carena	0320	Daewoo	0007, 0008, 0026, 0037, 0053,
Acme	0342	Atlantic	0277, 0320, 0342, 0349, 0350	Carnivale	0050		0167, 0266, 0275, 0277, 0282,
Acura	0323, 0343	Atori	0323, 0343	Carrefour	0344		0315, 0320, 0323, 0331, 0335,
ADC	0337	Auchan	0321	Carver	0010		0342, 0343, 0350, 0381, 0465
Admiral	0054, 0178, 0336, 0337, 0339,	Audiosonic	0161, 0282, 0320, 0340, 0342,	Cascade	0320, 0323, 0343	Dainichi	0277, 0340
	0346, 0347		0343, 0349, 0350	Casio	0367	Dansai	0277, 0282, 0320, 0337, 0349,
Advent	0158	AudioTon	0161, 0282, 0342	Cathay	0320, 0349, 0350		0350
Adventura	0057	Audiovox	0058, 0179, 0194	CCE	0183, 0282	Dantax	0161, 0349
Adyson	0277, 0282, 0342	Ausind	0171	Celebrity	0055, 0107	Dawa	0320
Agashi	0277, 0282	Autovox	0171, 0282, 0337, 0339, 0342	Celera	0039	Daytron	0007, 0008, 0026, 0323, 0343
Agazi	0337	Aventura	0051	Centurion	0320, 0349, 0350	De Graaf	0346
Aiko	0277, 0282, 0320, 0323, 0342,	Awa	0277, 0282	Century	0339	Decca	0282, 0320, 0342, 0349, 0350
	0343	Axion	0156	CGE	0161, 0171	Dell	0145, 0245
Aim	0320	Baird	0282	Changhong	0039	Denver	0358, 0362
Aiwa	0078, 0379	Bang & Olufsen	0180, 0339	Chimei	0273	Desmet	0320, 0349, 0350
Akai	0050, 0055, 0109, 0159, 0181,	Basic Line	0282, 0320, 0323, 0340, 0343,	Cimline	0323, 0343	Diamant	0320
	0277, 0282, 0320, 0323, 0340,		0350	Citizen	0007, 0008, 0026, 0050, 0058	Diamond	0277
	0343, 0349, 0350	Bastide	0282, 0342	City	0323, 0343	DiamondVision	0135, 0143
	0320, 0340	Baur	0320, 0349	Clarion	0179	Dimensia	0049
Akiba	0320, 0323, 0337, 0340	Bazin	0282	Clarivox	0349	Disney	0219
Alaron	0277	Beko	0161, 0269, 0294, 0302, 0311,	Clatronic	0161, 0171, 0282, 0320, 0323,	Dixi	0282, 0320, 0323, 0343, 0349,
Alba	0161, 0277, 0320, 0323, 0340,		0320, 0328, 0351		0337, 0340, 0342, 0343, 0350,		0350
	0342, 0343, 0344, 0349, 0351,	Belcor	0008		0351	Dream Vision	0461, 0498
	0372, 0382	Bell & Howell	0019, 0054	CMS	0277	DTS	0323, 0343
Albatron	0140	Benq	0097, 0242, 0361	CMS Hightec	0282	Dual	0282, 0320, 0342
Alcyon	0171	Beon	0320, 0349, 0350	Coby	0197	Dual-Tec	0342, 0343
Alleron	0059	Best	0161	Colortyme	0008, 0026	Dumont	0008, 0030, 0062, 0282, 0339,
Allorgan	0282	Bestar	0161, 0320, 0350	Commercial Solutions			0341, 0342
Allstar	0320, 0350	BGH	0400		0021	Durabrand	0031, 0051, 0179, 0215
America Action	0179	Binatone	0282, 0342	Concerto	0008, 0026	Dux	0349
AMOi	0276	Blue Sky	0320, 0340	Concorde	0323, 0343	Dwin	0178
Amplivision	0161, 0282, 0321, 0342	Blue Star	0348	Condor	0161, 0277, 0320, 0323, 0342,	Dynatron	0320, 0349, 0350
Amstrad	0320, 0323, 0337, 0340, 0343	Boots	0282, 0342		0350, 0351	Dynex	0228, 0231
Amtron	0058	BPL	0320, 0348	Contec	0179, 0277, 0323, 0342, 0343,	EIZO	0509
Anam	0179, 0343	Bradford	0058, 0179		0344	Elbe	0161, 0168, 0282, 0320
Anam National	0052, 0058	Brandt	0322, 0345	Contec/Cony	0012, 0058	Elcit	0339
Anglo	0323, 0343	Brilliant	0182	Continental Edison		Electa	0348
Anitech	0171, 0320, 0323, 0337, 0343	Brinkmann	0320		0345	ELECTRO TECH	0343
Ansonic	0161, 0168, 0320, 0323, 0341,	Brionvega	0320, 0339, 0349, 0350	Cosmel	0323, 0343	Electroband	0055, 0107
	0343	Britannia	0277, 0282, 0342	Craig	0058, 0179	Electrograph	0176
AOC	0008, 0026, 0050, 0053	Brockwood	0008	Crosley	0010, 0037, 0171, 0339	Electrohome	0008, 0026, 0052, 0055
Apex	0039, 0111, 0217	Broksonic	0109, 0179	Crown	0058, 0161, 0171, 0179, 0320,	Element	0230
Arcam	0277, 0282	Bruns	0339		0323, 0343, 0349, 0350, 0351	Elin	0277, 0320, 0323, 0342, 0349,
Arcam Delta	0342	BTC	0340	CS Electronics	0277, 0340, 0342		0350
Aristona	0320, 0349, 0350	Bush	0269, 0282, 0283, 0304, 0320,	CTC Clatronic	0341	Elite	0320, 0340, 0350
Arthur Martin	0321		0323, 0328, 0332, 0340, 0343,	CTX	0205	Elman	0341
ASA	0339, 0347		0344, 0346, 0348, 0349, 0350,	Curtis Mathes	0007, 0008, 0010, 0019, 0021,	Ela	0277, 0323, 0343
Asberg	0171, 0320, 0350		0372, 0382, 0463, 0470, 0472		0026, 0049, 0050, 0178	Emerson	0000, 0007, 0008, 0012, 0013,
Astra	0343	byd:sign	0093	CXC	0058, 0179		0019, 0026, 0031, 0037, 0051,
		Candle	0008, 0026, 0050, 0057	Cybertron	0340		0058, 0059, 0161, 0179, 0320,
		Capsonic	0337	Cytron	0152		0339

Emprex	0154	Genexxa	0320, 0340, 0347, 0350	Hygashi	0277, 0282, 0342	Kendo	0161, 0320, 0341, 0346
Envision	0008, 0026, 0050	GFM	0128, 0227	Hyper	0277, 0282, 0323, 0342, 0343	Kenwood	0008, 0026, 0050
Epson	0155, 0206, 0359	Giant	0282	Hypson	0282, 0320, 0321, 0337, 0342, 0348, 0349, 0350	KIC	0282
Erres	0320, 0349, 0350	Gibraltar	0008, 0030, 0050, 0062	Hyundai	0141	Kingsley	0277, 0342
ESA	0051	GoldHand	0277	Iberia	0320	KLH	0039
ESC	0282	Goldline	0320	ICE	0277, 0282, 0320, 0323, 0337, 0340, 0342, 0343, 0350	Kloss Novabeam	0057, 0058
Etron	0343	GoldStar	0007, 0008, 0012, 0026, 0031, 0050, 0053, 0161, 0277, 0282, 0320, 0323, 0342, 0343, 0346, 0349, 0350	ICeS	0277	Kneissel	0161, 0168, 0320
Eurofeel	0282			Ilo	0148, 0153	Kolster	0320, 0350
Euro-Feel	0337			IMA	0058	Konka	0340
Euroline	0349			Imperial	0161, 0171, 0320, 0347, 0350, 0351	Korpel	0320, 0349, 0350
Euroman	0161, 0277, 0282	Goodmans	0246, 0272, 0282, 0320, 0323, 0337, 0343, 0344, 0349, 0350, 0462, 0473, 0477			Korting	0161, 0339
Euromann	0320, 0337, 0342, 0350					Kosmos	0320
Europhon	0277, 0282, 0320, 0341, 0342, 0350					Koyoda	0343
		Gorenje	0161, 0351	Indiana	0320, 0349, 0350	KTV	0007, 0050, 0058, 0179, 0183, 0282, 0342
Expert	0321	GPM	0340	Infinity	0010		
Exquisit	0320	GPX	0129	InFocus	0250, 0327, 0363, 0479, 0508	Kyoto	0277, 0282
Fenner	0323, 0343	Gradiente	0240	Ingelen	0347	Lasat	0161
Ferguson	0322, 0345, 0349	Graetz	0347	Ingersol	0323, 0343	Lenco	0323, 0343
Fidelity	0277, 0320, 0342, 0346	Granada	0171, 0282, 0320, 0321, 0342, 0344, 0346, 0349, 0350	Initial	0153	Lenoir	0323, 0342, 0343
Filsai	0282			Inno Hit	0171, 0282, 0320, 0323, 0340, 0342, 0343, 0349, 0350	Leyco	0320, 0337, 0349, 0350
Finlandia	0346	Grandin	0340, 0343, 0348, 0349			LG	0031, 0053, 0066, 0116, 0117, 0140, 0161, 0164, 0175, 0195, 0269, 0277, 0282, 0300, 0309, 0317, 0320, 0323, 0328, 0342, 0343, 0346, 0349, 0350, 0366, 0368, 0377, 0466, 0471, 0478
Finlux	0171, 0282, 0320, 0339, 0341, 0342, 0349, 0350	Gronic	0282	Innovation	0337, 0343		
FIRST LINE	0342, 0343, 0350	Grundig	0160, 0161, 0171, 0310, 0320	Insignia	0131, 0228, 0236, 0238	LG/GoldStar	0164
Firstline	0277, 0282, 0320, 0323	Grunpy	0058, 0059, 0179	Inteq	0030	Liesenk	0349
Fisher	0019, 0161, 0282, 0339, 0342, 0344, 0351	Haier	0157, 0233	Interactive	0161	Liesenkotter	0320
Flint	0320, 0350	Halifax	0277, 0282, 0337, 0342	Interbuy	0323, 0343	Life	0337, 0343
Formenti	0171, 0277, 0336, 0339, 0342, 0349	Hallmark	0008, 0026, 0031	Interfunk	0161, 0320, 0339, 0347, 0349, 0350	Lifetec	0320, 0323, 0337, 0343
		Hampton	0277, 0282, 0342			Lloyds	0323
Formenti/Phoenix	0277	Hanseatic	0161, 0168, 0282, 0320, 0323, 0342, 0343, 0344, 0349, 0350	International	0277	Loewe	0161, 0168, 0265, 0320, 0330, 0352
Fortress	0336, 0339	Hantarex	0320, 0323, 0343	Intervision	0161, 0282, 0320, 0337, 0341, 0342	Loewe Opta	0339, 0349, 0350
Fraba	0161, 0320	Hantor	0320	Irradio	0171, 0320, 0323, 0340, 0343, 0349, 0350	Logik	0054
Friac	0161	Harman/Kardon	0010			Luma	0320, 0323, 0346, 0349
Frontech	0282, 0323, 0337, 0343, 0346, 0347	Harvard	0058, 0179	Isukai	0320, 0340	Lumatron	0282, 0320, 0346, 0349, 0350
Fujitsu	0059, 0069, 0074, 0075, 0282	Harwood	0320, 0323	ITC	0282, 0342	Lux May	0350
Fujitsu General	0282	Havermy	0178	ITS	0277, 0320, 0340, 0348, 0350	Luxman	0008, 0026
Fujitsu Siemens	0504, 0505, 0507, 0510, 0511	HCM	0282, 0320, 0323, 0337, 0342, 0343, 0348	ITT	0343, 0347	Luxor	0282, 0342, 0346
Funai	0051, 0058, 0059, 0112, 0113, 0115, 0118, 0119, 0179, 0337, 0488, 0489			ITV	0320, 0343, 0349	LXI	0010, 0019, 0021, 0026, 0027, 0031, 0049, 0111
		Hema	0282, 0323	Janeil	0057	M Electronic	0342, 0343, 0345, 0347, 0349, 0350
Futuretech	0058, 0179	Hewlett Packard	0192	JBL	0010	MAG	0096
Galaxi	0320, 0351	Higashi	0277	JC Penney	0007, 0008, 0026, 0027, 0049, 0053, 0056	Magnadyne	0339, 0341, 0349
Galaxis	0161, 0320	HiLine	0320			Magnafon	0171, 0277, 0341, 0342
Gateway	0176, 0177, 0241	Hinari	0320, 0323, 0340, 0343, 0344, 0349, 0350	JCB	0055, 0107	Magnavox	0008, 0009, 0010, 0013, 0026, 0032, 0033, 0048, 0050, 0128, 0211, 0212, 0224, 0226, 0239
GBC	0323, 0343, 0344			Jensen	0008, 0026		
GE	0008, 0021, 0023, 0026, 0027, 0031, 0034, 0049, 0052, 0056, 0209	Hisawa	0321, 0340, 0348	JVC	0012, 0014, 0015, 0056, 0064, 0065, 0067, 0169, 0174, 0297, 0314, 0344, 0350, 0375		
Geant Casino	0321	Hisense	0247				
GEC	0282, 0320, 0342, 0347, 0349, 0350	Hitachi	0008, 0012, 0026, 0066, 0084, 0092, 0093, 0120, 0172, 0173, 0255, 0270, 0271, 0282, 0320, 0335, 0338, 0342, 0344, 0346, 0347, 0365, 0382, 0448, 0456, 0467, 0482, 0484, 0487	Kaisui	0277, 0282, 0320, 0323, 0340, 0342, 0343, 0348		
Geloso	0323, 0343, 0346			Kamosonic	0342		
General Technic	0323, 0343	Hornyphon	0320, 0350	Kamp	0277, 0342		
		Hoshai	0340	Kapsch	0347	Magnum	0337, 0343
		Huanyu	0277, 0342	Karcher	0161, 0320, 0342, 0343, 0349	Majestic	0054
				Kawasho	0008, 0026, 0055, 0277	Mandor	0337
				KEC	0179		

Manesth	0282, 0320, 0337, 0342, 0349, 0350	NEI	0320, 0349, 0350	Philips	0008, 0009, 0010, 0011, 0012, 0032, 0048, 0049, 0052, 0122, 0128, 0134, 0186, 0187, 0213, 0221, 0224, 0226, 0239, 0256, 0257, 0259, 0261, 0263, 0267, 0280, 0281, 0287, 0296, 0299, 0301, 0303, 0305, 0313, 0319, 0320, 0324, 0333, 0339, 0342, 0349, 0350, 0353, 0357, 0360, 0380, 0383, 0452, 0459, 0460	Radiomarelli	0320, 0339
Marantz	0008, 0010, 0026, 0050, 0204, 0320, 0349, 0350	Net-TV	0176	Phoenix	0011, 0032, 0033	Radiotone	0161, 0320, 0323, 0350
Marelli	0339	Neufunk	0320, 0323	Phonola	0277, 0320, 0339, 0349, 0350	Rank	0344
Mark	0277, 0282, 0320, 0323, 0349, 0350	New Tech	0343, 0350	Pilot	0007, 0008, 0050	RCA	0008, 0021, 0024, 0025, 0026, 0027, 0042, 0049, 0052, 0053, 0063, 0136, 0225
Masuda	0282	New World	0340	Pioneer	0008, 0026, 0094, 0095, 0161, 0320, 0345, 0347, 0349, 0350, 0458, 0480	Realistic	0019, 0031, 0050, 0179
Matsui	0282, 0320, 0323, 0342, 0343, 0344, 0346, 0349, 0350, 0455	NewTech	0282, 0320, 0323	Plantron	0320, 0323, 0337, 0350	Recor	0320
Matsushita	0017	Nicamagic	0277, 0342	Playsonic	0282	Redstar	0320
Maxent	0147, 0176	Nikkai	0277, 0282, 0320, 0323, 0337, 0340, 0342, 0349, 0350	Polaroid	0039, 0142, 0202, 0234	Reflex	0320
Mediator	0320, 0349, 0350	Nobliko	0171, 0277, 0341, 0342	Poppy	0323, 0343	Revox	0161, 0320, 0349, 0350
Medion	0320, 0337, 0343	Nokia	0347	Portland	0007, 0008, 0026, 0053	Rex	0337, 0346, 0347
Megapower	0140	Norcent	0201	Prandoni-Prince	0171, 0346	RFT	0161, 0168, 0339
Megatron	0026, 0031	Nordic	0282	Precision	0282, 0342	Rhapsody	0277
MElectronic	0277, 0282, 0320, 0323	Nordmende	0339, 0345, 0347, 0350	Prima	0157, 0243, 0323, 0343, 0347	R-Line	0320, 0349, 0350
Melvox	0321	Nordvision	0349	Princeton	0140	Roadstar	0323, 0337, 0340, 0343
Memorex	0019, 0026, 0031, 0053, 0054, 0137, 0215, 0323, 0343	Novatronic	0320	Prism	0023, 0056	Robotron	0339
Memphis	0323, 0343	Oceanic	0321, 0347	Profex	0323, 0343	Rowa	0277, 0282, 0400, 0403, 0494
Mercury	0320, 0323	Okano	0161, 0320, 0351	Profi-Tronic	0320, 0350	Royal Lux	0161
Metz	0339	Olevia	0102, 0199, 0200, 0207, 0222	Proline	0320, 0350	RTF	0339
MGA	0008, 0026, 0031, 0050, 0053	ONCEAS	0342	Proscan	0021, 0027, 0049	Runco	0030, 0050, 0062
Micromaxx	0337, 0343	Onwa	0058, 0179	Prosonic	0161, 0277, 0282, 0320, 0342, 0349	Saba	0298, 0322, 0339, 0345, 0347
Microstar	0337, 0343	Opera	0320	Protech	0282, 0337, 0341, 0342, 0343, 0349, 0350	Saisho	0282, 0323, 0337, 0342, 0343
Midland	0007, 0021, 0023, 0027, 0030, 0056, 0062	Oppo	0130	Proton	0008, 0012, 0026, 0031	Salora	0346, 0347
Minerva	0171	Optimus	0017, 0019	Prottron	0196	Sambers	0171, 0341
Minoka	0320, 0350	Optoma	0144	PROVIEW	0096, 0246	Sampo	0007, 0008, 0026, 0050, 0176, 0400
Mintek	0153	Optonica	0178	Provision	0320, 0349	Samsung	0004, 0005, 0006, 0007, 0008, 0012, 0026, 0031, 0036, 0050, 0053, 0076, 0077, 0079, 0114, 0124, 0125, 0126, 0127, 0139, 0161, 0183, 0185, 0190, 0191, 0258, 0264, 0277, 0282, 0320, 0323, 0334, 0337, 0342, 0343, 0349, 0350, 0351, 0373, 0453, 0468
Mitsubishi	0008, 0026, 0031, 0053, 0066, 0084, 0093, 0098, 0150, 0178, 0289, 0320, 0339, 0344, 0350, 0376	Orbit	0320, 0350	Pulsar	0008, 0030, 0062	Sandra	0277, 0282, 0342
Mivar	0161, 0168, 0171, 0277, 0282, 0342	Orion	0043, 0146, 0283, 0320, 0323, 0328, 0343, 0349, 0350	Pye	0256, 0320, 0349, 0350, 0378	Sansui	0043, 0109, 0320, 0350, 0400
Monivision	0140	Orline	0320	Pymi	0323, 0343	Sanyo	0008, 0019, 0068, 0070, 0071, 0099, 0161, 0168, 0223, 0237, 0277, 0282, 0288, 0295, 0323, 0342, 0344, 0369, 0469
Montgomery Ward	0054	Osaki	0282, 0320, 0337, 0340, 0342	Quandra Vision	0321	SBR	0320, 0349
Motion	0171	Oso	0340	Quasar	0017, 0023, 0052, 0056	Sceptre	0235, 0244
Motorola	0052, 0178	Otto Versand	0282, 0320, 0336, 0342, 0344, 0348, 0349, 0350	Quelle	0282, 0320, 0337, 0342, 0349, 0350	Schaub Lorenz	0347
MTC	0008, 0026, 0050, 0053, 0161, 0277	Pael	0277, 0342	Quella	0350	Schneider	0282, 0316, 0318, 0320, 0333, 0340, 0342, 0349, 0350, 0382
Multi System	0349	Palladium	0161, 0282, 0320, 0342, 0351	Questa	0344	Scotch	0026, 0031
Multitech	0058, 0161, 0179, 0183, 0277, 0282, 0320, 0323, 0341, 0342, 0343, 0344, 0346, 0349	Palsonic	0282	Radialva	0320	Scott	0008, 0012, 0026, 0031, 0058, 0059, 0149, 0179
Murphy	0277, 0342	Panama	0277, 0282, 0320, 0323, 0337, 0342, 0343	RadioShack	0019, 0021, 0031, 0050, 0179, 0320	Sears	0008, 0010, 0019, 0021, 0026, 0027, 0031, 0049, 0051, 0059, 0111
NAD	0026, 0031, 0111	Panasonic	0016, 0017, 0020, 0022, 0023, 0035, 0052, 0056, 0084, 0085, 0133, 0163, 0193, 0284, 0286, 0290, 0292, 0320, 0325, 0347, 0356, 0483, 0485, 0490	RadioShack/Realistic	0007, 0008, 0012, 0026, 0049, 0058	SEG	0277, 0282, 0320, 0323, 0337, 0341, 0342, 0344, 0349, 0382
Naonis	0346	Panavision	0320	Radiola	0282, 0320, 0349, 0350		
NEC	0008, 0026, 0050, 0052, 0053, 0072, 0103, 0282, 0344	Pathe Cinema	0161, 0168, 0277, 0321, 0342				
Neckermann	0161, 0282, 0320, 0339, 0342, 0346, 0349, 0350, 0351	Pausa	0323, 0343				
		Penney	0021, 0023, 0031, 0050, 0111				
		Perdio	0277, 0320				
		Perfekt	0320				
		Philco	0008, 0009, 0010, 0012, 0026, 0050, 0052, 0053, 0161, 0171, 0320, 0339				
		Philharmonic	0282, 0342				

SEI	0320	SuperTech	0277, 0320, 0323	Tomashi	0348	White Westinghouse	
SEI-Sinudyne	0339, 0341, 0347	Supra	0323, 0343	Toshiba	0018, 0019, 0040, 0041, 0046, 0073, 0100, 0103, 0108, 0109, 0111, 0121, 0132, 0166, 0208, 0210, 0214, 0217, 0260, 0268, 0282, 0283, 0293, 0304, 0306, 0307, 0329, 0344, 0355, 0454, 0491		0037, 0090, 0277, 0320, 0341, 0342, 0349
Seleco	0344, 0346, 0347	Supre-Macy	0057			Wincom	0101, 0106
Sencora	0323, 0343	Supreme	0055, 0107			Xrypton	0320
Sentra	0323	Susumu	0340			Yamaha	0008, 0026, 0050, 0053, 0080, 0081, 0082, 0083, 0086, 0087
Serino	0277	Sutron	0323, 0343			Yamishi	0282, 0320
Sharp	0000, 0001, 0002, 0003, 0007, 0008, 0012, 0026, 0060, 0088, 0089, 0091, 0138, 0165, 0170, 0178, 0198, 0229, 0262, 0278, 0279, 0291, 0308, 0312, 0336, 0344, 0354, 0370, 0449, 0450, 0451, 0464, 0474, 0476, 0481	SVA	0151			Yokan	0320
		Sydney	0277, 0282, 0342			Yoko	0161, 0277, 0282, 0320, 0323, 0337, 0340, 0342, 0343, 0349, 0350
		Sylvania	0008, 0009, 0010, 0011, 0013, 0026, 0048, 0050, 0051, 0128, 0227, 0253	Totevision	0007	Yorx	0340
				Towada	0282, 0347	Zanussi	0282, 0346
		Symphonic	0051, 0058, 0062, 0128, 0179, 0215	Trakton	0282	Zenith	0008, 0028, 0029, 0030, 0031, 0054, 0061, 0062
				Trans Continens	0282, 0320		
		Syntax	0199	Transtec	0277		
Sheng Chia	0178	Syntax-Brilliant	0199	Trident	0282		
Shogun	0008	Sysline	0349	Triumph	0320		
Siarem	0320, 0339, 0341	Sytong	0277	Uher	0161, 0171, 0320, 0347, 0350		
Sierra	0320, 0350	Tandy	0178, 0282, 0336, 0340, 0342, 0347	Ultravox	0277, 0320, 0339, 0341, 0342		
Siesta	0161			Unic Line	0320		
Signature	0054	Tashiko	0277, 0282, 0342, 0344, 0346	United	0349		
Silva	0277	Tatung	0052, 0177, 0282, 0320, 0342, 0349, 0350	Universum	0161, 0171, 0282, 0320, 0337, 0349, 0350, 0351		
Silver	0344			Univox	0320		
Singer	0321, 0339, 0341	TCM	0337, 0343	Vector Research	0050		
Sinudyne	0320, 0339, 0341, 0349	TCL	0400, 0401, 0403, 0406, 0494	Vestel	0282, 0320, 0346, 0347, 0349, 0350, 0351		
Skantic	0347	Teac	0282, 0320, 0400				
Skyworth	0402, 0492, 0493, 0495	Tec	0282, 0323, 0342, 0343	Vexa	0320, 0323, 0343, 0349		
Solavox	0347	Technics	0017, 0023, 0056	Victor	0015, 0344, 0350		
Sonitron	0161, 0282	TechniSat	0274, 0496, 0497, 0499	VIDEOLOGIC	0277		
Sonoko	0282, 0320, 0323, 0337, 0342, 0343, 0349, 0350	Techwood	0008, 0023, 0026, 0056	Videologique	0277, 0282, 0340, 0342		
		TEDELEX	0282	VideoSystem	0320, 0350		
Sonorlor	0321, 0347	Teknika	0007, 0008, 0010, 0012, 0026, 0053, 0054, 0058, 0059, 0179	Videotechnic	0277, 0282		
Sontec	0161, 0320, 0349, 0350			Vidikron	0010		
Sony	0038, 0044, 0045, 0047, 0055, 0090, 0104, 0105, 0107, 0110, 0123, 0184, 0220, 0248, 0249, 0251, 0252, 0254, 0326, 0343, 0344, 0371, 0374, 0457, 0475, 0486	Teleavia	0345	Vidtech	0008, 0026, 0031, 0053		
		Telecor	0282, 0320	Viewsonic	0176, 0203, 0232, 0364		
Sound & Vision	0340, 0341	Telefunken	0320, 0322, 0345, 0350	Viking	0057		
Soundesign	0008, 0026, 0031, 0058, 0059, 0179	Telegazi	0320	Viore	0148		
		Telemeister	0320	Visiola	0277, 0342		
Soundwave	0320, 0349, 0350	Telesonic	0320	Vision	0282, 0320, 0350		
Squareview	0051	Telestari	0320	Vizio	0008, 0177, 0218, 0242, 0500, 0501, 0502, 0503, 0506		
SSS	0008, 0058, 0179	Teletech	0320, 0323, 0343, 0349				
Standard	0282, 0320, 0323, 0340, 0342, 0343, 0350	Teleton	0282, 0342	Vortec	0320, 0349, 0350		
		Televideon	0277	Voxson	0171, 0320, 0339, 0346, 0347, 0350		
Starlite	0058, 0179, 0320, 0323, 0349	Televiso	0321				
Stenway	0348	Tensai	0282, 0320, 0323, 0340, 0343, 0350	Waltham	0282, 0320, 0342		
Stern	0346, 0347	Tesmet	0350	Wards	0008, 0009, 0010, 0026, 0031, 0048, 0049, 0050, 0053, 0054, 0059		
Strato	0320, 0323	Tevion	0337, 0343				
Stylandia	0282	Texet	0277, 0282, 0323, 0342	Watson	0320, 0349, 0350		
Sunkai	0343	Thomson	0162, 0188, 0189, 0285, 0320, 0322, 0342, 0345, 0350	Watt Radio	0277, 0341, 0342		
Sunstar	0320, 0323			Waycon	0111		
Sunwood	0320, 0323, 0343, 0350	Thorn	0320, 0349	Wega	0320, 0339, 0344		
Superla	0277, 0282, 0342	TMK	0008, 0026, 0031	Wegavox	0323		
Superscan	0013, 0178	TNCi	0030	Weltblick	0282, 0320, 0349, 0350		
		Tokai	0282, 0320, 0350	Westinghouse	0107, 0216, 0220		
		Tokyo	0277, 0342				

Bush	1008, 1009, 1024, 1025, 1029, 1049, 1051, 1063, 1217	Fisher	1065	Instant Replay	1068	Mitsubishi	1026, 1028, 1079
Calix	1071	Flint	1024	Interbuy	1008, 1031	Motorola	1068
Candle	1070, 1071	Formenti/Phoenix	1028	Interfunk	1028	MTC	1070
Canon	1068	Frontech	1030	Intervision	1009, 1026	Multitech	1008, 1026, 1028, 1029, 1030, 1069, 1070
Cathay	1009	Fuji	1068	Irradio	1008, 1029, 1031	Murphy	1026
Catron	1030	Fujitsu	1026	ITT	1027	NEC	1027, 1064, 1065
CGE	1026, 1027	Funai	1026, 1069	ITV	1009, 1025, 1031	Neckermann	1027, 1028
Cimline	1008, 1024, 1029	Galaxy	1026	JC Penney	1064, 1065, 1068, 1070, 1071	NEI	1028
CineVision	1104	Garrard	1069	JCL	1068	Nesco	1008, 1029
Citizen	1070, 1071	Gateway	1016	JVC	1007, 1018, 1027, 1039, 1064, 1065, 1066, 1067, 1078, 1089, 1092, 1093, 1094, 1095, 1113, 1208, 1209, 1212, 1213, 1215, 1218	Nikkai	1008, 1009, 1030
Clatronic	1008, 1030	GBC	1029, 1030			Nikko	1071
Colortyme	1064	GE	1068, 1070			Niveus Media	1016
Condor	1009, 1025, 1030	GEC	1028			Noblex	1070
Craig	1070, 1071	Geloso	1029	Kaisui	1008, 1029	Nokia	1009, 1027
Crown	1008, 1009, 1025, 1029, 1030	General	1030	Karcher	1028	Nordmende	1027
Curtis Mathes	1064, 1068, 1070	General Technic	1024	Kendo	1008, 1024, 1025, 1030	Northgate	1016
Cybernex	1070	GOI	1018	Kenwood	1027, 1064, 1065	Oceanic	1026, 1027
CyberPower	1016	GoldHand	1008, 1029	Kodak	1068, 1071	Okano	1008, 1009, 1024
Daewoo	1009, 1025, 1030, 1038, 1069, 1223	Goldstar	1026, 1031, 1064, 1071	Korpel	1008, 1029	Olympus	1068
Dansai	1008, 1009, 1029	Goodmans	1008, 1009, 1025, 1026, 1029, 1030, 1031	Kyoto	1008	Optimus	1071
Dantax	1024	Gradiente	1069	Lenco	1025	Orion	1023, 1024, 1051, 1115, 1217
Daytron	1009, 1025	Graetz	1027	Leyco	1008, 1029	Orson	1026
DBX	1064	Granada	1028	LG	1010, 1026, 1031, 1047, 1054, 1056, 1071, 1103, 1221	Osaki	1008, 1026, 1029, 1031
De Graaf	1028	Grandin	1008, 1009, 1025, 1026, 1029, 1030, 1031	Lifetec	1024	Otto Versand	1028
Decca	1026, 1027, 1028	Grundig	1028, 1029	Linksys	1016	Palladium	1008, 1027, 1029, 1031
Dell	1016	Hanseatic	1009, 1028, 1031	Lloyd's	1069	Panasonic	1000, 1022, 1044, 1055, 1068, 1072, 1085, 1090, 1091, 1120, 1121, 1214
Denko	1008	Harley Davidson	1069	Loewe Opta	1028, 1031	Pathe Marconi	1027
DiamondVision	1096	Harman/Kardon	1064	Logik	1008, 1029	Perdio	1026
DigiFusion	1014	Harwood	1008	Lumatron	1009, 1025	Philco	1008, 1068
DIRECTV	1019, 1105, 1110, 1111, 1113, 1116, 1122	HCM	1008, 1029	Luxor	1008	Philips	1006, 1013, 1028, 1035, 1040, 1045, 1046, 1050, 1058, 1059, 1061, 1068, 1076, 1101, 1110, 1113, 1116, 1117, 1122, 1126, 1210, 1211
Dish Network	1018	Headquarter	1065	LXI	1071	Philips Magnavox	1076
Dishpro	1018	Hewlett Packard	1016	M Electronic	1026	Phonola	1028
Dual	1009, 1027, 1028	Hinari	1008, 1009, 1024, 1029	Magnavox	1020, 1068, 1114, 1126	Pilot	1071
Dumont	1026, 1028	Hisawa	1024	Magnin	1071	Pioneer	1028, 1036
Durabrand	1114	Hitachi	1011, 1026, 1027, 1028, 1046, 1062	Manesth	1008, 1029	Polaroid	1088, 1099
Dynatech	1069	HNS	1110	Marantz	1028, 1064, 1065, 1068	Portland	1009, 1025, 1030
Echostar	1018	Howard Computers		Mark	1009	Prinz	1026
Elbe	1009		1016	Marta	1071	Profex	1029
Elcotech	1008	HP	1016	Matsui	1024, 1031	Proline	1026
Electrohome	1071	HTS	1018	Matsushita	1068	Proscan	1019
Electrophonic	1071	Hughes	1111, 1113, 1122	Media Center PC	1016	Prosonic	1009, 1024
Elsay	1008	Hughes Network Systems		Mediator	1028	Pulsar	1114
Elta	1008, 1009, 1029		1110, 1116	Medion	1024	Pye	1028, 1102
Emerson	1008, 1020, 1068, 1069, 1071	Humax	1012, 1110, 1113	MEI	1068	Quarter	1065
ESC	1009, 1025	Hush	1016	Memorex	1023, 1026, 1031, 1065, 1068, 1069, 1070, 1071, 1098, 1114	Quartz	1065
Etzuko	1008, 1029	Hypson	1008, 1009, 1024, 1029	Memphis	1008, 1029	Quasar	1068
Expressvu	1018	iBUYPOWER	1016	MGN Technology	1070	Quelle	1026, 1028
Ferguson	1027	Impego	1030	Micromaxx	1024	Radialva	1008
Fidelity	1008, 1026	Imperial	1026	Microsoft	1016		
Finlandia	1028	Inno Hit	1008, 1009, 1025, 1028, 1029, 1030	Microstar	1024		
Finlux	1026, 1027, 1028	Innovation	1024	Migros	1026		
Firstline	1008, 1024, 1029, 1031			Mind	1016		



RadioShack	1071	Stack 9	1016	Voodoo	1016	California Audio Labs	
RadioShack/Realistic		Standard	1009, 1025	Wards	1068, 1069, 1070, 1071		2151
	1065, 1068, 1069, 1070, 1071	Stern	1009	Weltblick	1031	Cambridge Audio	2354
Radiola	1028	STS	1068	XR-1000	1068, 1069	CAT	2352, 2353
Radix	1071	Sunkai	1024	Yamaha	1064, 1065	CAVS	2192
Randex	1071	Sunstar	1026	Yamishi	1008, 1029	Centrum	2353
RCA	1019, 1068, 1070, 1075, 1110, 1113, 1122, 1125	Suntronic	1026	Yokan	1008, 1029	CGV	2354, 2362
Realistic	1065, 1068, 1069, 1070, 1071	Sunwood	1008, 1029	Yoko	1008, 1029, 1030, 1031	Changhong	2140
ReplayTV	1022, 1123	Superscan	1020	Zenith	1114	Cinotec	2363
Rex	1027	Sylvania	1020, 1068, 1069, 1102, 1126	ZT Group	1016	CineVision	2133, 2237
RFT	1008, 1028, 1030	Symphonic	1008, 1069, 1126			Clatronic	2358, 2367
Ricavision	1016	Systemax	1016			Coby	2031, 2046, 2360
Roadstar	1008, 1009, 1025, 1029, 1031	Tagar Systems	1016			Conia	2383
Royal	1008	Taisho	1024			Continental Edison	
Runco	1114	Tandberg	1009				2363
Saba	1027	Tandy	1065			Crown	2362
Saisho	1024, 1029	Tashiko	1026, 1071			C-Tech	2355
Samsung	1002, 1034, 1041, 1043, 1057, 1060, 1070, 1084, 1110, 1116, 1122, 1124, 1220, 1222	Tatung	1026, 1027, 1028			Curtis Mathes	2139
		TCM	1015, 1024, 1042			CVG	2377
		Teac	1009, 1069			CyberHome	2022, 2098, 2138, 2187, 2336
		Tec	1008, 1009, 1030			Cytron	2244
Samurai	1008, 1030	Technics	1068			Daenyx	2363
Sanky	1114	Teknika	1068, 1069, 1071			Daewoo	2001, 2133, 2276, 2298, 2330, 2362, 2363, 2377
Sansui	1023, 1027, 1106, 1115	Teleavia	1027			Daewoo International	
Sanyo	1032, 1065, 1070	Telefunken	1027				2363
Saville	1009	Teletech	1008, 1009			Dalton	2357
SBR	1028	Tenosal	1008, 1029			Dansai	2362, 2381
Schaub Lorenz	1026, 1027	Tensai	1008, 1026, 1029, 1031			Daytek	2184, 2195, 2363
Schneider	1008, 1009, 1024, 1025, 1026, 1028, 1029, 1030, 1031	Tevion	1024			Dayton	2363
		Thomson	1005, 1027			DEC	2358
Sears	1065, 1068, 1071	Thorn	1027			Decca	2362
SEG	1008, 1009, 1029	Tivo	1108, 1110, 1111, 1113, 1117, 1118, 1119, 1122			Denon	2059, 2151, 2193, 2332
SEI-Sinudyne	1028					Denver	2356, 2358, 2360, 2370
Seleco	1027	TMK	1070			Denzel	2380
Sentra	1008, 1030	Tokai	1008, 1029, 1031			Desay	2205
Sentron	1008, 1029	Tonsai	1029			Diamond	2354, 2355
Sharp	1003, 1033, 1077, 1107, 1127, 1219	Toshiba	1004, 1016, 1027, 1028, 1037, 1049, 1052, 1086, 1087, 1097, 1109, 1112, 1194			DiamondVision	2225, 2232
						Disney	2010, 2028
Shintom	1008, 1029					DK Digital	2339
Shivaki	1031	Totevision	1070, 1071			Dmtech	2176
Shogun	1070	Touch	1016			Dual	2380
Siemens	1031	Towada	1008, 1029			DUNE	2509
Silva	1031	Towika	1008, 1029			Durabrand	2136
Silver	1009	TVA	1030			DVX	2355
Singer	1068	Uher	1031			Easy Home	2359
Simudyne	1028	UltimateTV	1019			Eclipse	2354
Solavox	1030	Ultravox	1009			E-Dem	2364
Sonic Blue	1022, 1123	Unitech	1070			Electrohome	2362
Sonneclair	1008	United Quick Star	1009, 1025			Elin	2362
Sonoko	1009, 1025	Universum	1026, 1028, 1031			Elta	2341, 2361, 2362
Sontec	1031	Vector Research	1064			Emerson	2129, 2137, 2150
Sony	1001, 1016, 1048, 1053, 1073, 1074, 1080, 1081, 1082, 1083, 1108, 1118, 1216	Video Concepts	1064			Enterprise	2129
		Videon	1024			Enzer	2380
		Videosonic	1070			Epson	2247
Stack	1016	Viewsonic	1016				

---

## DVD

4Kus	2051		
Accurian	2142		
Advent	2155, 2251		
AEG	2362		
Airis	2364		
Aiwa	2322		
Akai	2145, 2177, 2179, 2248		
Akura	2356		
Alba	2064, 2165, 2186, 2337, 2346		
Alco	2149		
Alize	2361		
Allegro	2133		
Amitech	2362		
Amphion MediaWorks			
	2195		
AMW	2195, 2363		
Apex	2030, 2124, 2125, 2126, 2127, 2130, 2131		
Apple	2241		
Argo	2138		
Ason	2364		
Aspire	2152, 2222		
Astar	2240		
ATACOM	2364		
Audiovox	2061, 2149		
Avious	2367		
Awa	2363		
Axion	2249		
Bang & Olufsen	2128		
Baze	2367		
BBK	2364		
Bellagio	2363		
Best Buy	2359		
Blaupunkt	2131		
Blue Parade	2157		
Boghe	2382		
Brainwave	2362		
Brandt	2148, 2188		
Broksonic	2145, 2146		
Bush	2064, 2110, 2170, 2268, 2290, 2346, 2358, 2367, 2383		

ESA	2137	Kiss	2380	Optim	2381	Rowa	2154, 2383
Finlux	2354, 2362, 2367	KLH	2131, 2149	Optimus	2180	Rownsonic	2353
Fintec	2377	Koda	2358	Orava	2358	Saba	2148, 2188
Fisher	2134	Koss	2013, 2148, 2158	Orbit	2363	Sabaki	2355
Funai	2137	KXD	2359	Orion	2073, 2110	Saivod	2362
Gateway	2051	Landel	2143	Oritron	2148, 2158	Sampo	2141
GE	2029, 2131, 2156	Lasonic	2132	P&B	2358	Samsung	2000, 2045, 2077, 2112, 2113, 2114, 2115, 2151, 2200, 2216, 2219, 2228, 2264, 2265, 2271, 2279, 2294, 2303, 2329, 2365
Gericom	2351	Lawson	2355	Pacific	2355	Sansui	2073, 2145, 2354, 2355, 2362
GFM	2226	Lecson	2381	Panasonic	2011, 2024, 2034, 2042, 2058, 2062, 2066, 2067, 2093, 2116, 2117, 2118, 2119, 2120, 2121, 2122, 2123, 2151, 2159, 2164, 2166, 2167, 2172, 2173, 2175, 2209, 2214, 2275, 2277, 2278, 2281, 2282, 2283, 2301, 2374, 2470	Sanyo	2134, 2145, 2217, 2292
Giec	2382	Lenco	2358, 2362, 2367			ScanMagic	2186
Global Solutions	2355	Lenoxx	2136, 2153			Schaub Lorenz	2362
Global Sphere	2355	LG	2002, 2033, 2038, 2057, 2129, 2133, 2189, 2191, 2223, 2238, 2270, 2288, 2335, 2373, 2375			Schneider	2176
Go Video	2133, 2213					Scientific Labs	2355
Goodmans	2165, 2280, 2291, 2358, 2371, 2376, 2382	Life	2182	Parasound	2197	Scott	2161, 2357
GPX	2227	Lifetec	2182	peeKTON	2364	Seeltech	2364
Gradiente	2151	Limit	2355	Philips	2008, 2012, 2025, 2044, 2050, 2051, 2053, 2060, 2072, 2108, 2111, 2147, 2159, 2163, 2169, 2174, 2181, 2185, 2230, 2261, 2266, 2267, 2286, 2287, 2289, 2295, 2300, 2302, 2317, 2328, 2338, 2342, 2350, 2467	SEG	2161, 2355, 2363, 2380
Graetz	2380	Liquid Video	2158			Sharp	2006, 2040, 2088, 2091, 2182, 2194, 2220, 2221, 2231, 2236, 2293, 2340
Greenhill	2131	Liteon	2043, 2051, 2142			Shinsonic	2245
Grundig	2349	Loewe	2320			Sigmathek	2359, 2364
Grunkel	2362, 2366	LogicLab	2355			Silva	2356
GVG	2377	Magnavox	2025, 2050, 2137, 2150, 2159, 2224, 2230, 2358			Singer	2354, 2355
H&B	2358					Skymaster	2325, 2355
H_her	2364	Magnex	2367			Skyworth	2356
Haaz	2354, 2355	Majestic	2360	Phonotrend	2367	Slim Art	2362
Haier	2254	Marantz	2328	Pioneer	2016, 2017, 2018, 2019, 2035, 2092, 2094, 2095, 2109, 2157, 2180, 2190, 2212, 2269, 2272, 2299, 2304, 2305, 2306, 2307, 2308, 2309, 2310, 2311, 2344, 2345, 2347, 2379	SM Electronic	2355
Harman/Kardon	2047, 2135	Marquant	2362			Sonic Blue	2133
HiMAX	2359	Matsui	2148, 2378			Sontech	2366
Hitachi	2062, 2090, 2115, 2274, 2316, 2359, 2380	McIntosh	2199			Sony	2004, 2005, 2007, 2009, 2014, 2015, 2023, 2026, 2027, 2052, 2068, 2069, 2070, 2071, 2074, 2075, 2084, 2085, 2087, 2168, 2171, 2208, 2210, 2211, 2258, 2273, 2284, 2285, 2312, 2313, 2314, 2315, 2318, 2319, 2466
Hiteker	2130	Mecotek	2362			Soundmaster	2355
Home Tech Industries		Medion	2182			Soundmax	2355
	2364	Memorex	2028, 2145, 2234	Pointer	2362	Spectra	2363
Hyundai	2366	MiCO	2354, 2382	Polaroid	2125, 2215, 2235	Spectroniq	2201
Ilo	2245	Micromaxx	2182	Portland	2362	Standard	2355
Initial	2131, 2245	Microsoft	2156	Powerpoint	2363	Star Cluster	2355
Innovation	2182	Microstar	2182	Prima	2252	Starmedia	2358, 2364
Insignia	2002, 2137, 2253	Minoka	2362	Proceed	2130	Sungale	2204
Integra	2157	Minowa	2367	Proscan	2156	Sunkai	2362
Irradio	2053	Mintek	2131, 2245	Prosonic	2360, 2377	Superscan	2150
iSymphony	2246	Mitsubishi	2003	Prottron	2202	Supervision	2355
JBL	2135	Mizuda	2358, 2359	Provision	2358	Sylvania	2012, 2137, 2150, 2178, 2230, 2239
JVC	2020, 2096, 2097, 2099, 2100, 2101, 2102, 2103, 2106, 2107, 2160, 2257, 2260, 2262, 2263, 2321, 2324, 2326, 2327, 2343, 2464, 2465, 2468, 2469, 2471	Monyka	2380	Pye	2144	Symphonic	2108, 2230
		Mustek	2186	Qwestar	2148	Synn	2355
Jwin	2198	Mx Onda	2354	Raite	2380	T.D.E. Systems	2366
Kansai	2360	Mystral	2366	RCA	2021, 2029, 2104, 2105, 2131, 2149, 2156, 2157, 2229		
Kawasaki	2149	Naiko	2362	RedStar	2356, 2360, 2362		
Kennex	2362	Nesa	2131	Regent	2153		
Kenwood	2041, 2151, 2348	Neufunk	2380	Reoc	2355		
KeyPlug	2362	Nevir	2362	Rimax	2361		
Kiuro	2362	Next Base	2143	Rio	2133		
Kingavon	2358	Nexstech	2243	Roadstar	2331, 2358		
		NU-TEC	2383	Ronin	2363		
		Onkyo	2159, 2368	Rotel	2203		
		Oopla	2051				
		Oppo	2196, 2255				

Tatung	2001, 2362
TCM	2182, 2297
Teac	2149, 2333, 2355, 2383
Tec	2356
Technics	2151
Technika	2362, 2367
Telefunken	2353
Tensai	2362
Tevion	2182, 2355, 2357
Theta Digital	2157
Thomson	2183, 2188, 2334, 2372
Tokai	2356, 2380
Top Suxess	2364
Toshiba	2032, 2036, 2037, 2039, 2048, 2049, 2054, 2055, 2072, 2073, 2076, 2078, 2079, 2086, 2145, 2159, 2218, 2233, 2256, 2259, 2296, 2369, 2508
TRANScontinents	2363, 2367
Transonic	2367
Trio	2362
Trutech	2242
TruVision	2359
TSM	2364
Umax	2361
United	2367
Urban Concepts	2159
US Logic	2245
Venturer	2149
Viewmaster	2364
Vocopro	2206
VocoStar	2207
Waitec	2364
Welltech	2382
Westinghouse	2063, 2250
Wharfedale	2354, 2355
Woxter	2361, 2364
Xbox	2156, 2183
Xlogic	2355, 2362
XMS	2362
Xoro	2382
Yamada	2051, 2361, 2363
Yamaha	2056, 2064, 2065, 2080, 2081, 2082, 2083, 2089, 2118, 2151, 2323
Yamakawa	2363, 2380
Yukai	2186
Zenith	2002, 2129, 2133, 2159, 2223

## Blu-ray Disc

Denon	2452, 2500, 2501
Hitachi	2460, 2461, 2463

JVC	2472, 2473, 2475, 2478, 2496, 2499, 2511
LG	2033, 2456, 2457
Marantz (US)	2454, 2455
Mitsubishi	2450, 2451
Onkyo	2504
Panasonic	2011, 2209, 2214, 2476, 2477, 2479
Philips	2510
Pioneer	2212, 2506
Samsung	2045, 2113, 2498
Sharp	2194, 2220, 2221, 2497, 2502, 2503
Sony	2075, 2453, 2458, 2459, 2507
Toshiba	2462
Yamaha	2064, 2448, 2449, 2474, 2505

## DVR

Bush	2110
Hitachi	2090
Panasonic	2066, 2067, 2093, 2116, 2117, 2119, 2120, 2122, 2123
Philips	2108, 2111
Pioneer	2016, 2017, 2018, 2019, 2092, 2094, 2095, 2109
RCA	2105
Samsung	2113, 2219
Sharp	2088, 2091
Sony	2084, 2085, 2087
Toshiba	2086
Victor	2475
Yamaha	2089, 2118

## DVD Recorder

Aspire	2222
Astar	2240
Broksonic	2146
Go Video	2213
Hitachi	2062
Insignia	2002
Irradio	2053
JVC	2100, 2101, 2106, 2107
LG	2033, 2057, 2223, 2238
Liteon	2043
Panasonic	2011, 2034, 2058, 2062, 2116, 2117, 2119, 2120, 2121, 2123
Philips	2008, 2044, 2050, 2051, 2147
Pioneer	2017, 2035
Pye	2144
Samsung	2000, 2112, 2216
Sansui	2073

Sanyo	2217
Sony	2004, 2005, 2007, 2052, 2068, 2069, 2074, 2208, 2210, 2211
Sylvania	2239
Toshiba	2032, 2036, 2037, 2039, 2049, 2054, 2055, 2076
Yamaha	2056

## Cable

ABC	3002, 3003, 3017, 3066, 3067, 3086, 3093, 3119, 3122
ADB	3020
Adelphia	3081
Alcatel	3016
Americast	3124
Amstrad	3022, 3098
Antronix	3065, 3070
Archer	3070
Arcon	3098
AT&T	3095
Axis	3098
Bell South	3124
Cable Vision	3092
Cabletenna	3065
Cabletime	3104
Cableview	3087
Clearmaster	3127
ClearMax	3127
Clyde Cablevision	3105
Colour Voice	3068
Comcast	3084, 3088, 3117
Comcrypt	3107
Comtronics	3069
Contec	3074
Coolmax	3127
COX	3084
Cryptovision	3110
Director	3084
Eastern	3075
Everquest	3123
Fidelity	3098
Filmnet	3107
Filmnet Cablecrypt	3111
Filmnet Comcrypt	3111
Finlux	3097
FIOS	3005
Focus	3126
Foxtel	3022
France Telecom	3100, 3101
Freebox	3023
GC Electronics	3070

GE	3066, 3093
GEC	3105
Gemini	3072, 3123
General Instrument	3017, 3025, 3066, 3084, 3090, 3096, 3117
Goldstar	3120
Gooding	3099
Grundig	3098, 3099
Hamlin	3073, 3078
Hirschmann	3097
Hitachi	3066
HomeChoice	3106
Humax	3021, 3080, 3083
ITT Nokia	3097
Jasco	3123
Jerrold	3017, 3018, 3025, 3066, 3072, 3084, 3090, 3096, 3119, 3123
JVC	3099
Kabel Deutschland	3024, 3027, 3121
Macab	3101
Magnavox	3079
Maspro	3099
Matsui	3099
MegaCable	3117
Memorex	3076, 3122
Minerva	3099
Mnet	3107
Motorola	3025, 3026, 3084, 3088, 3090, 3095, 3117
Movie Time	3077, 3109
Mr Zapp	3101
Multichoice	3107
Multitech	3127
NEC	3064
NET Brazil	3085
Nokia	3097
Noos	3101
NSC	3077
Oak	3074
Pace	3006, 3089, 3121
Palladium	3099
Panasonic	3112, 3118, 3122
Paragon	3122
Philips	3068, 3071, 3079, 3099, 3100, 3101, 3103
Pioneer	3001, 3006, 3094, 3098, 3114, 3116, 3120
Popular Mechanics	3126
Proscan	3066, 3093
Pulsar	3122
PVP Stereo Visual Matrix	3018

Quasar 3122  
 RadioShack 3123, 3127  
 RCA 3030, 3031, 3087, 3118  
 Realistic 3070  
 Recoton 3126  
 Regal 3078  
 Regency 3075  
 Rembrandt 3066  
 Runco 3122  
 Sagem 3101  
 Samsung 3069, 3089, 3114, 3120  
 SAT 3098  
 Scientific Atlanta 3000, 3001, 3002, 3003, 3006,  
 3028, 3029, 3081, 3086, 3089,  
 3094, 3095, 3108  
 Signal 3072, 3123  
 Signature 3066  
 Sony 3092, 3125  
 Sprucer 3118  
 Standard Component  
 3115  
 Starcom 3017, 3072, 3119, 3123  
 Stargate 3072, 3123  
 Starquest 3072, 3123  
 Supercable 3090  
 Supermax 3127  
 Tele+1 3107, 3111  
 TELENET 3004  
 Telepiu 3107  
 Thomson 3082, 3091  
 TIME WARNER 3084  
 Tocom 3067  
 Torx 3017  
 Toshiba 3122  
 Tristar 3127  
 Tudi 3102  
 Tusa 3072, 3123  
 TV86 3077  
 Unika 3065, 3070  
 United Cable 3018, 3119  
 Universal 3065, 3070  
 Universum 3097, 3099  
 V2 3127  
 Verizon Fios 3007  
 Videoway 3019  
 View Star 3074, 3077, 3079  
 Viewmaster 3127  
 Vision 3127  
 Visiopass 3097, 3100, 3101  
 Vortex View 3127  
 Wittenberg 3098  
 Zenith 3113, 3122, 3124  
 Zentek 3126

## Satellite

AB Sat 4216, 4217  
 AccessHD 4104  
 ADB 4220  
 AGS 4216  
 Akai 4053, 4055  
 Alba 4001, 4004, 4006, 4007, 4062,  
 4217  
 Aldes 4005, 4007, 4010  
 Allsat 4048, 4053, 4055  
 Allsonic 4005, 4008, 4024  
 Alltech 4217  
 Alpha 4053  
 Alpha Digital 4104  
 Alphastar 4077  
 Amitronica 4217  
 Amstrad 4011, 4035, 4217, 4218  
 Anglo 4217  
 Ankaro 4005, 4008, 4024, 4217  
 Anttron 4001, 4004  
 Apollo 4001  
 Armstrong 4011, 4053  
 Artec 4100  
 Asat 4053, 4055  
 ASLF 4217  
 Astacom 4216  
 Astra 4009, 4011, 4054, 4217, 4219  
 Astro 4004, 4008, 4010, 4015, 4024,  
 4213, 4218, 4219  
 AudioTon 4004, 4048  
 Aurora 4222, 4246  
 Auster 4222, 4246  
 Axiel 4216  
 Axis 4008, 4009, 4024, 4050  
 BBK 4205  
 Best 4008, 4024  
 Blaupunkt 4015  
 Blue Sky 4217  
 Boca 4011, 4054, 4059, 4217  
 Boston 4216  
 Brain Wave 4013  
 Broadcast 4012  
 Broco 4217  
 BSkyB 4035, 4041  
 BT 4216  
 Bubu Sat 4217  
 Bush 4006, 4045  
 Cambridge 4218  
 Canal Satellite 4213  
 Canal+ 4213  
 CaptiveWorks 4099  
 Channel Master 4007, 4110  
 Chaparral 4075

CHEROKEE 4216  
 Chess 4212, 4217  
 CityCom 4006, 4215, 4219  
 Clatronic 4013  
 CNT 4010  
 Comag 4080, 4081, 4082, 4083, 4086  
 Commlink 4005  
 Comtech 4050  
 Condor 4008, 4024, 4219  
 Connexions 4014, 4024  
 Conrad 4024, 4215, 4218, 4219  
 Conrad Electronic 4217, 4219  
 Contec 4050  
 Coolsat 4096  
 Cosat 4048  
 Coship 4109  
 Crown 4011  
 Daeryung 4014  
 Daewoo 4057, 4217  
 DDC 4007  
 Delega 4007  
 Dew 4050  
 Diamond 4051  
 Digiality 4219  
 Digital Stream 4105  
 DIRECTV 4056, 4064, 4067, 4068, 4070,  
 4071, 4074, 4107, 4116, 4119,  
 4121, 4122, 4123, 4127, 4192,  
 4193, 4194, 4195, 4196, 4197,  
 4198, 4199, 4200, 4201, 4202,  
 4203, 4206, 4207, 4221  
 Discoverer 4212  
 Discovery 4216  
 Diseqc 4216  
 Dish Network 4018, 4065, 4089, 4092, 4094,  
 4095, 4117  
 Dishpro 4018, 4117  
 Distrisat 4053  
 Ditristrad 4048  
 DNT 4014, 4053, 4055  
 Drake 4072  
 DStv 4222, 4246  
 Dune 4024, 4240, 4242  
 Echostar 4014, 4018, 4065, 4089, 4117,  
 4217  
 Einhell 4001, 4005, 4011, 4217, 4218  
 Elap 4216, 4217  
 Elekta 4010  
 Elsat 4217  
 Elta 4001, 4008, 4024, 4048, 4053,  
 4055  
 Emanon 4001  
 Emme Esse 4008, 4024  
 Engel 4217  
 Ep Sat 4006

EURIEULT 4031  
 Eurodec 4052  
 Europa 4053, 4218, 4219  
 Europhon 4219  
 Eurosat 4011  
 Eurosky 4008, 4011, 4215, 4218, 4219,  
 4024  
 Eurostar 4011, 4215, 4219  
 Eutelsat 4217  
 Exator 4001, 4004  
 Expressvu 4117  
 Fenner 4024, 4212, 4217  
 Ferguson 4006, 4052, 4214  
 Fidelity 4218  
 Finlandia 4006  
 Finlux 4006  
 FinnSat 4050, 4052  
 Flair Mate 4217  
 Foxtel 4204, 4222, 4244, 4245, 4246,  
 4247  
 Freecom 4001, 4049, 4218  
 FTEmaximal 4024, 4217  
 Fuba 4001, 4008, 4014, 4015, 4024,  
 4055, 4215  
 Galaxis 4005, 4008, 4009, 4024, 4048,  
 4050, 4215, 4222, 4246  
 GE 4066, 4093, 4111, 4197  
 General Instrument  
 4019, 4073  
 GMI 4011  
 GOI 4117  
 Goldbox 4213  
 GoldStar 4049  
 Goodmans 4002, 4006, 4029  
 Goodmind 4111  
 Grandin 4031  
 Grothusen 4001, 4049  
 Grundig 4004, 4006, 4015, 4035, 4211,  
 4218, 4222, 4246  
 Hänsel & Gretel 4219  
 Hantor 4001, 4013  
 Hanuri 4010  
 Hauppauge 4044  
 Heliocom 4219  
 Helium 4219  
 Hinari 4007  
 Hirschmann 4015, 4024, 4210, 4216, 4218,  
 4219  
 Hisawa 4013  
 Hisense 4016  
 Hitachi 4006, 4114, 4199, 4203  
 Homecast 4084, 4085, 4087  
 Houston 4048  
 HTS 4117

Hughes	4064, 4068, 4192, 4194, 4196, 4202	Maspro	4006, 4217	Panasonic	4006, 4035, 4036, 4121, 4124, 4126, 4198, 4221	Satec	4217
Hughes Network Systems	4071	Matsui	4216	Panda	4006, 4219	Satelco	4024
Humax	4025, 4030, 4060, 4097	Max	4219	Pansat	4125	Satford	4012
Huth	4005, 4011, 4012, 4013, 4048, 4050, 4219, 4223	Mediabox	4213	Patriot	4216	Satmaster	4012
Hypson	4031	Mediamarkt	4011	Paysat	4127	Satplus	4212
Ilo	4016	Mediasat	4009, 4213, 4218	PCT	4110	Schneider	4008, 4212, 4216
Imex	4031	Medion	4217	Philco	4101	Schwaiger	4051, 4212, 4219
Innovation	4008	Mega	4053, 4055	Philips	4006, 4033, 4053, 4055, 4061, 4068, 4071, 4127, 4196, 4201, 4202, 4203, 4206, 4213, 4216	SCS	4215
Insighnia	4107	Memorex	4127	Phoenix	4050	Seemann	4009, 4011, 4014
Intertronic	4011	Metronix	4001, 4004, 4005, 4010, 4028, 4031, 4217	Phonotrend	4006, 4005, 4048	SEG	4001, 4008, 4013, 4024
Intervision	4048, 4219	Metz	4015	Pioneer	4046, 4213	Seleco	4048
ITT Nokia	4006	Micro electronic	4217, 4218, 4219	Polsat	4052	Servi Sat	4031, 4217
Jerrold	4019	Micro Technology	4217	Predki	4013	Siemens	4015
Johansson	4013	MicroGem	4106	Premiere	4048, 4213	Silva	4049
JOK	4216	Micromaxx	4008, 4024	Priesner	4011	Skantin	4217
JSR	4048	Microstar	4008	Primestar	4076	Skardin	4009
JVC	4029, 4065, 4089, 4117	Microtec	4217	Profile	4216	Skinsat	4218
Kamm	4217	Minerva	4015	Promax	4006	SKR	4217
Kathrein	4015, 4034, 4042, 4053, 4055, 4063, 4215, 4216, 4217	Mitsubishi	4006, 4015, 4202	Prosat	4005, 4007	Sky Italia	4204
Kathrein Eurostar	4215	Mitsumi	4054	Proscan	4066, 4093, 4122, 4197	Skymaster	4005, 4017, 4022, 4212, 4217
Klap	4216	Morgan's	4011, 4053, 4054, 4055, 4217	Protek	4051	Skymax	4053, 4055
Konig	4219	Motorola	4019, 4088, 4090, 4091	Proton	4016	SkySat	4212, 4217, 4218, 4219
Kosmos	4049	Multichoice	4222, 4246	Provision	4010	Skyvision	4048
KR	4004	Multitec	4212	Quadral	4005, 4007, 4008, 4216, 4024	SM Electronic	4212, 4217
Kreiselmeier	4015	Muratto	4049	Quelle	4015, 4215, 4219	Smart	4215, 4217
K-SAT	4217	Mysat	4217	Quiero	4052	Sony	4067, 4070, 4213
Kyostar	4001	Navex	4013	RadioShack	4019	SR	4011, 4054
L&S Electronic	4024	Neuhaus	4009, 4048, 4217, 4218, 4219	Radiola	4053, 4055	Star Choice	4019
Lasat	4008, 4010, 4024, 4054, 4212, 4215, 4219	Neusat	4217	Radix	4014, 4037	Starland	4217
Lasonic	4108	Next Level	4019	Rainbow	4004	Starring	4013
Lenco	4001, 4024, 4049, 4215, 4217, 4219	NextWave	4223	RCA	4066, 4093, 4112, 4113, 4116, 4118, 4119, 4197, 4122, 4207	Start Trak	4001
Leng	4013	Nikko	4011, 4217	Realistic	4078	Strong	4001, 4004, 4008, 4024, 4049, 4222, 4246
Lennox	4048	Nokia	4006, 4040	Redpoint	4009	STS	4115
Lenson	4218	Nordmende	4001, 4006, 4007, 4010, 4052	Redstar	4008, 4024	STVI	4031
Lexus	4053	Nova	4222	RFT	4005, 4053, 4055	Sumida	4011
LG	4049, 4103, 4107	Novis	4013	Roadstar	4217	Sunny Sound	4024
Lifesat	4008, 4024, 4212, 4217	Oceanic	4051	Roch	4031	Sunsat	4217
Lifetec	4008	Octagon	4001, 4004, 4050	Rover	4024, 4217	Sunstar	4011, 4024, 4054
Lorenzen	4219	Okano	4011	Saba	4010, 4215, 4216, 4219	Supermax	4223
Lorraine	4049	Optex	4048	Sabre	4006	Tandberg	4052
Lupus	4008, 4024	Optus	4204, 4213, 4222, 4223, 4246	Sagem	4023, 4052	Tandy	4004
Luxor	4218	Orbitech	4001, 4212, 4213, 4218	Sakura	4050	Tantec	4006
Lyonnaise	4052	OSat	4004	Samsung	4000, 4001, 4003, 4032, 4064, 4069, 4071, 4120, 4123, 4196, 4200	TCM	4008
Macab	4052	Otto Versand	4015	SAT	4007, 4218	Techniland	4012
Magnavox	4127, 4101	Pace	4006, 4015, 4035, 4043, 4047, 4204, 4216, 4243	Sat Cruiser	4223	TechniSat	4014, 4021, 4026, 4027, 4038, 4039, 4053, 4212, 4213, 4218
Manata	4031, 4216, 4217	Pacific	4051	Sat Partner	4001, 4004, 4010, 4013, 4049, 4218	Technology	4222
Manhattan	4006, 4010, 4048, 4216	Packsat	4216	Sat Team	4217	Technosat	4223
Marantz	4055	Palcom	4007	Satcom	4012, 4219	Technowelt	4219
Mascom	4010	Palladium	4011, 4218			Teco	4011, 4054
		Palsat	4212, 4218			Telanor	4007
		Panasat	4222, 4246			Telasat	4215, 4219
						Telecom	4217
						Telefunken	4001, 4017, 4216

Teleka 4004, 4011, 4014, 4218, 4219  
 Telemaster 4010  
 TELENET 4241  
 Telesat 4219  
 Telestar 4212, 4213, 4218  
 Televes 4006, 4218  
 Telewire 4048  
 Tempo 4223  
 Tevion 4008, 4217  
 Thomson 4006, 4020, 4052, 4058, 4208,  
 4213, 4215, 4216, 4217, 4219  
 4051  
 Thorens  
 Thorn 4006  
 Tivax 4104  
 Tivo 4196  
 Tokai 4053  
 Tonna 4006, 4012, 4048, 4217, 4218  
 Toshiba 4194, 4202, 4203  
 Triad 4049  
 Triasat 4218  
 Triax 4015, 4215, 4217, 4218  
 Turnsat 4217  
 Tvonics 4214  
 Twinner 4031, 4217  
 UEC 4204, 4222, 4246  
 Uher 4212  
 UltimateTV 4070  
 Uniden 4079, 4127  
 Unisat 4011, 4050, 4053  
 Unitor 4013  
 Universum 4015, 4215, 4219  
 US Digital 4016  
 Variosat 4015  
 Vega 4024  
 Ventana 4053, 4055  
 Viewsat 4098  
 Visiosat 4013, 4048, 4216, 4217  
 Voom 4019  
 Vortec 4001  
 Welltech 4212  
 WeTeKom 4212, 4218  
 Wevasat 4006  
 Wewa 4006  
 Winersat 4013  
 Wisi 4006, 4014, 4015, 4218, 4219  
 Woorisat 4010  
 Worldsat 4216  
 Xrypton 4024  
 XSat 4217  
 Zehnder 4008, 4209, 4010, 4215, 4024  
 Zenith 4102, 4107, 4195  
 Zodiac 4004

---

## CD

Yamaha 5082, 5095, 5114

---

## CD Recorder

Yamaha 5083

---

## MD

Yamaha 5080, 5081, 5086

---

## Tape

Yamaha 5084, 5087

---

## Tuner

Yamaha 5066, 5085, 5088, 5090, 5092

---

## LD

Yamaha 2080

---

## Amplifier

Yamaha 5098

---

## Apple TV

Apple 2241

Yamaha Global Site  
<https://www.yamaha.com/>

Yamaha Downloads  
<http://download.yamaha.com/>

Manual Development Group  
© 2017 Yamaha Corporation

Published 05/2017 AM-A0

YJ291A0/EN2