



CD-N500

Network CD Player



IMPORTANT SAFETY INSTRUCTIONS

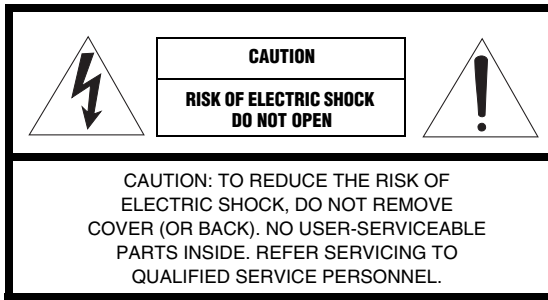

• Explanation of Graphical Symbols

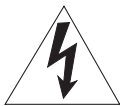

The lightning flash with arrowhead symbol, within an equilateral triangle, is intended to alert you to the presence of uninsulated “dangerous voltage” within the product’s enclosure that may be of sufficient magnitude to constitute a risk of electric shock to persons.



The exclamation point within an equilateral triangle is intended to alert you to the presence of important operating and maintenance (servicing) instructions in the literature accompanying the appliance.

IMPORTANT

Please record the serial number of this unit in the space below.

MODEL:

Serial No.:

The serial number is located on the rear of the unit. Retain this manual in a safe place for future reference.

- 1 Read these instructions.
- 2 Keep these instructions.
- 3 Heed all warnings.
- 4 Follow all instructions.
- 5 Do not use this apparatus near water.
- 6 Clean only with dry cloth.
- 7 Do not block any ventilation openings. Install in accordance with the manufacturer’s instructions.
- 8 Do not install near any heat sources such as radiators, heat registers, stoves, or other apparatus (including amplifiers) that produce heat.
- 9 Do not defeat the safety purpose of the polarized or grounding-type plug. A polarized plug has two blades with one wider than the other. A grounding type plug has two blades and a third grounding prong. The wide blade or the third prong are provided for your safety. If the provided plug does not fit into your outlet, consult an electrician for replacement of the obsolete outlet.
- 10 Protect the power cord from being walked on or pinched particularly at plugs, convenience receptacles, and the point where they exit from the apparatus.
- 11 Only use attachments/accessories specified by the manufacturer.
- 12 Use only with the cart, stand, tripod, bracket, or table specified by the manufacturer, or sold with the apparatus. When a cart is used, use caution when moving the cart/apparatus combination to avoid injury from tip-over.
- 13 Unplug this apparatus during lightning storms or when unused for long periods of time.
- 14 Refer all servicing to qualified service personnel. Servicing is required when the apparatus has been damaged in any way, such as power-supply cord or plug is damaged, liquid has been spilled or objects have fallen into the apparatus, the apparatus has been exposed to rain or moisture, does not operate normally, or has been dropped.



We Want You Listening For A Lifetime

Yamaha and the Electronic Industries Association’s Consumer Electronics Group want you to get the most out of your equipment by playing it at a safe level. One that lets the sound come through loud and clear without annoying blaring or distortion – and, most importantly, without affecting your sensitive hearing. Since hearing damage from loud sounds is often undetectable until it is too late, Yamaha and the Electronic Industries Association’s Consumer Electronics Group recommend you to avoid prolonged exposure from excessive volume levels.



FCC INFORMATION (for US customers)

1 **IMPORTANT NOTICE: DO NOT MODIFY THIS UNIT!**

This product, when installed as indicated in the instructions contained in this manual, meets FCC requirements. Modifications not expressly approved by Yamaha may void your authority, granted by the FCC, to use the product.

2 **IMPORTANT:** When connecting this product to accessories and/or another product use only high quality shielded cables. Cable/s supplied with this product **MUST** be used. Follow all installation instructions. Failure to follow instructions could void your FCC authorization to use this product in the USA.

3 **NOTE:** This product has been tested and found to comply with the requirements listed in FCC Regulations, Part 15 for Class "B" digital devices. Compliance with these requirements provides a reasonable level of assurance that your use of this product in a residential environment will not result in harmful interference with other electronic devices.

This equipment generates/uses radio frequencies and, if not installed and used according to the instructions found in the users manual, may cause interference harmful to the operation of other electronic devices.

Compliance with FCC regulations does not guarantee that interference will not occur in all installations. If this product is found to be the source of interference, which can be determined by turning the unit "OFF" and "ON", please try to eliminate the problem by using one of the following measures:

Relocate either this product or the device that is being affected by the interference.

Utilize power outlets that are on different branch (circuit breaker or fuse) circuits or install AC line filter/s.

In the case of radio or TV interference, relocate/reorient the antenna. If the antenna lead-in is 300 ohm ribbon lead, change the lead-in to coaxial type cable.

If these corrective measures do not produce satisfactory results, please contact the local retailer authorized to distribute this type of product. If you can not locate the appropriate retailer, please contact Yamaha Corporation of America A/V Division, 6600 Orangethorpe Ave., Buena Park, CA 90620.

The above statements apply **ONLY** to those products distributed by Yamaha Corporation of America or its subsidiaries.

COMPLIANCE INFORMATION STATEMENT (DECLARATION OF CONFORMITY PROCEDURE)

Responsible Party: Yamaha Corporation of America
A/V Division
Address: 6600 Orangethorpe Avenue
Buena Park, CA 90620, USA
Telephone: 1-714-522-9011
Type of Equipment: Network CD Player
Model Name: CD-N500

- This device complies with Part 15 of the FCC Rules.
 - Operation is subject to the following conditions:
 - This device may not cause harmful interference.
 - This device must accept any interference received including interference that may cause undesired operation.
- See the troubleshooting section in this Owner's Manual if interference to radio reception is suspected.

FCC CAUTION

Change or modifications not expressly approved by the party responsible for compliance could void the user's authority to operate the equipment.

CAUTION: READ THIS BEFORE OPERATING YOUR UNIT.

- 1 To assure the finest performance, please read this manual carefully. Keep it in a safe place for future reference.
- 2 Install this sound system in a well ventilated, cool, dry, clean place - away from direct sunlight, heat sources, vibration, dust, moisture, and/or cold. For proper ventilation, allow the following minimum clearances.
Top: 10 cm (4 in)
Rear: 10 cm (4 in)
Sides: 10 cm (4 in)
- 3 Locate this unit away from other electrical appliances, motors, or transformers to avoid humming sounds.
- 4 Do not expose this unit to sudden temperature changes from cold to hot, and do not locate this unit in an environment with high humidity (i.e. a room with a humidifier) to prevent condensation inside this unit, which may cause an electrical shock, fire, damage to this unit, and/or personal injury.
- 5 Avoid installing this unit where foreign object may fall onto this unit and/or this unit may be exposed to liquid dripping or splashing. On the top of this unit, do not place:
 - Other components, as they may cause damage and/or discoloration on the surface of this unit.
 - Burning objects (i.e. candles), as they may cause fire, damage to this unit, and/or personal injury.
 - Containers with liquid in them, as they may fall and liquid may cause electrical shock to the user and/or damage to this unit.
- 6 Do not cover this unit with a newspaper, tablecloth, curtain, etc. in order not to obstruct heat radiation. If the temperature inside this unit rises, it may cause fire, damage to this unit, and/or personal injury.
- 7 Do not plug in this unit to a wall outlet until all connections are complete.
- 8 Do not operate this unit upside-down. It may overheat, possibly causing damage.
- 9 Do not use force on switches, knobs and/or cords.
- 10 When disconnecting the power cable from the wall outlet, grasp the plug; do not pull the cable.
- 11 Do not clean this unit with chemical solvents; this might damage the finish. Use a clean, dry cloth.
- 12 Only voltage specified on this unit must be used. Using this unit with a higher voltage than specified is dangerous and may cause fire, damage to this unit, and/or personal injury. Yamaha will not be held responsible for any damage resulting from use of this unit with a voltage other than specified.
- 13 To prevent damage by lightning, keep the power cable and outdoor antennas disconnected from a wall outlet or this unit during a lightning storm.
- 14 Do not attempt to modify or fix this unit. Contact qualified Yamaha service personnel when any service is needed. The cabinet should never be opened for any reasons.
- 15 When not planning to use this unit for long periods of time (i.e. vacation), disconnect the AC power plug from the wall outlet.
- 16 Be sure to read the “TROUBLESHOOTING” section on common operating errors before concluding that this unit is faulty.
- 17 Before moving this unit, press \odot to set this unit to the standby mode, and disconnect the AC power plug from the wall outlet.
- 18 Condensation will form when the surrounding temperature changes suddenly. Disconnect the power cable from the outlet, then leave this unit alone.
- 19 When using this unit for a long time, this unit may become warm. Turn the power off, then leave this unit alone for cooling.
- 20 Install this unit near the AC outlet and where the AC power plug can be reached easily.
- 21 The batteries shall not be exposed to excessive heat such as sunshine, fire or the like.
 - Keep the batteries in a location out of reach of children. Batteries can be dangerous if a child were to put in his or her mouth.
 - If the batteries grow old, the effective operation range of the remote control decreases considerably. If this happens, replace the batteries with two new ones as soon as possible.
 - Do not use old batteries together with new ones.
 - Do not use different types of batteries (such as alkaline and manganese batteries) together. Read the packaging carefully as these different types of batteries may have the same shape and color.
 - Exhausted batteries may leak. If the batteries have leaked, dispose of them immediately. Avoid touching the leaked material or letting it come into contact with clothing, etc. Clean the battery compartment thoroughly before installing new batteries.
 - If you plan not to use the unit for a long period of time, remove the batteries from the unit. Otherwise, the batteries will wear out, possibly resulting in a leakage of battery liquid that may damage the unit.
 - Do not throw away batteries with general house waste. Dispose of them correctly in accordance with your local regulations.
- 22 Excessive sound pressure from earphones and headphones can cause hearing loss.

This unit is not disconnected from the AC power source as long as it is connected to the wall outlet, even if this unit itself is turned off by \odot . This state is called the standby mode. In this state, this unit is designed to consume a very small quantity of power.

WARNING

TO REDUCE THE RISK OF FIRE OR ELECTRIC SHOCK, DO NOT EXPOSE THIS UNIT TO RAIN OR MOISTURE.

WARNING

DO NOT TOUCH THIS UNIT WHEN IT IS USED CONTINUOUSLY AT HIGH VOLUME BECAUSE THE BOTTOM OF THIS UNIT MAY BECOME HOT. IT MAY LEAD TO INJURIES SUCH AS BURNS, ETC.

WHAT YOU CAN DO WITH THIS UNIT

This unit is a network CD player, on which you can enjoy playing back music files stored on your media server (PC or NAS), audio contents on the Internet, CD, iPod and USB devices, by connecting the unit to your home network (DLNA) and audio system on the same network.



For details on DLNA or NAS, see “ADDITIONAL INFORMATION” (P.30).

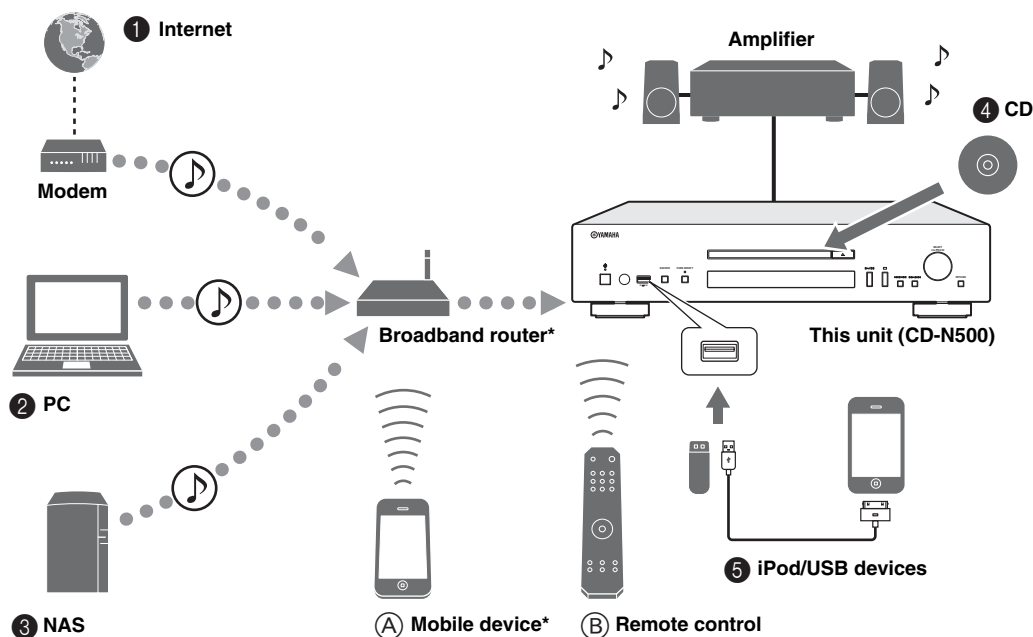

* You need a commercially available WiFi broadband router when you use a mobile device.

■ Sources that can be played back on this unit

- ① Play back audio contents on the Internet (P.16)
- ② Play back music files stored on your PC (P.11, 14)
- ③ Play back music files stored on your NAS (P.11, 14)
- ④ Play back a CD (P.18)
- ⑤ Play back your iPod or USB devices (P.20)



For details on connecting the devices, see “CONNECTIONS” (P.9).

■ Devices that can control this unit

- (A) Control this unit using your mobile devices (P.11, 13)
- (B) Control this unit using the remote control (P.6, 14, 16, 18, 20, 22, 23)

FREQUENTLY ASKED QUESTIONS

What kind of settings do I need to make?

- For details on settings of your PC, NAS or mobile devices, see “SETUP OF YOUR PC/NAS/MOBILE DEVICES” (P.11).
- For details on the setup menu on this unit, see “SETUP MENU” (P.23).

Why can't I find music files on my PC?

- Check the media sharing settings of your PC or media server, such as Windows Media Player 12 (P.11).
- Check if the music files are playable (P.31).

Can I control this unit with my iPhone?

- For details on controlling this unit from your mobile device, see “Operations from your mobile device” (P.13).

I can't find this unit using the dedicated application installed on my mobile device!

- Check if this unit is properly connected to the same network via the broadband router.
- Check if access to this unit is restricted by MAC address filter function (P.27).

What music files are playable on this unit?

- For details on playable files and formats, see “PLAYABLE DISCS AND FILE FORMATS” (P.31).

How can I listen to Internet radio on this unit?

- For details on listening to Internet radio stations, see “PLAYBACK OF AUDIO CONTENTS ON THE INTERNET” (P.16).

How do I play back my iPod or USB devices?

- For details on playback of your iPod or USB devices, see “PLAYBACK OF YOUR iPod/USB DEVICES” (P.20).

What do the messages on the front panel display stand for?

- For details on the front panel display messages, see “Front panel display messages” (P.29).

For latest information, please visit Yamaha website.

CONTENTS

PREPARATION

WHAT YOU CAN DO WITH THIS UNIT	1
FREQUENTLY ASKED QUESTIONS	2
SUPPLIED ACCESSORIES	4
REMOTE CONTROL PREPARATION.....	4
CONTROLS AND FUNCTIONS	5
Front panel	5
Remote control.....	6
Rear panel	8
CONNECTIONS	9
Connecting to an amplifier.....	9
Connecting to a network (PC/NAS/Internet connection).....	10
Turning on this unit.....	10

OPERATIONS

SETUP OF YOUR PC/NAS/MOBILE DEVICES	11
Sharing music files stored on your PC.....	12
Operations from your mobile device	13
PLAYBACK OF MUSIC FILES ON YOUR PC/NAS.....	14
Operations from the main unit or remote control	14
PLAYBACK OF AUDIO CONTENTS ON THE INTERNET	16
Listening to Internet radio stations	16
PLAYBACK OF CDS	18
Playing back a CD	18
Using program playback mode	19
PLAYBACK OF YOUR iPod/USB DEVICES	20
Connecting your iPod or USB devices	20
Playing back your iPod	20
Using extended playback mode for your iPod	21
Playing back USB devices	22
SETUP MENU	23
Setup menu operations	23
Setup menu list.....	24
Advanced setup menu	25

OTHERS

TROUBLESHOOTING	26
Front panel display messages.....	29
ADDITIONAL INFORMATION	30
PLAYABLE DISCS AND FILE FORMATS	31
Playable media and devices	31
Playable discs and file formats	32
SPECIFICATIONS.....	33
(at the end of this manual) Information about software	i

About this manual

- Notes contain important information about safety and operating instructions.  indicates a tip for your operation.
- “iPod” described in this manual may also refer to “iPhone” or “iPad”.

SUPPLIED ACCESSORIES

Check that you have received all of the following items.

Remote control

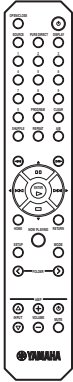

RCA stereo cable

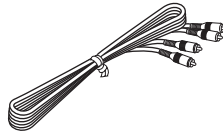

Power cable

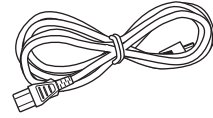

Batteries (AA, R6, UM-3) (x 2)

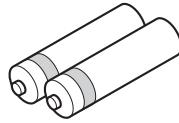

Owner's manual



REMOTE CONTROL PREPARATION

■ Installing the batteries

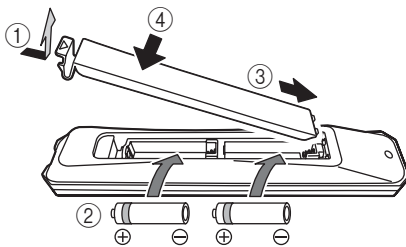

Notes

- Change all batteries if the operation range of the remote control narrows.
- Before inserting new batteries, wipe the compartment clean.

■ Operation range

Aim the remote control directly at the remote control sensor on the main unit during operation.

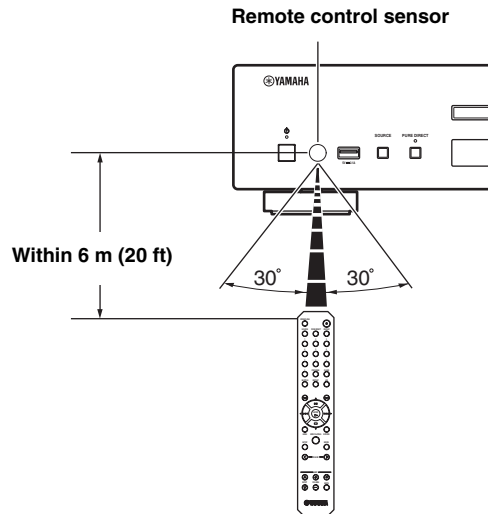

CONTROLS AND FUNCTIONS

Front panel

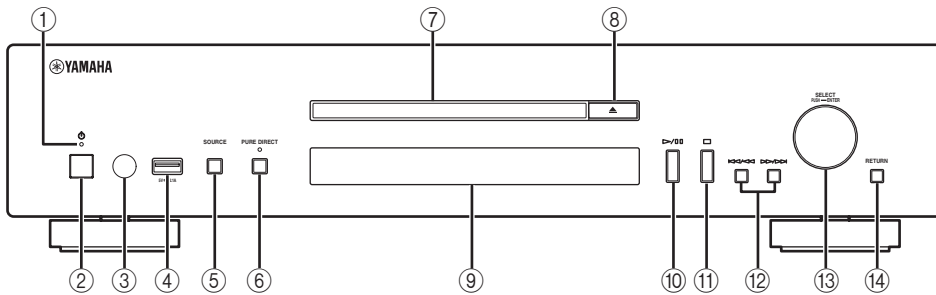

① Power indicator

• Lights up:

This unit is in a state that you can switch the unit to on or standby mode with the remote control or mobile devices (when network standby mode is on), or this unit is turned on.

• Lights up dimly:

This unit is in a state that you can turn the unit on with the remote control (when network standby mode is off).

• Off:

This unit is turned off and you can turn the unit on with the power switch on the front panel of the main unit only.



You can switch the setting of the network standby mode to on or off in the setup menu (☞ P.24).

② Power switch (☞ P.10)

Switches this unit between on and off.



③ Remote control sensor (☞ P.4)

Receives infrared signals from the remote control.

④ USB port (☞ P.20)

Connects your iPod or USB devices.

⑤ SOURCE (☞ P.14, 16, 18, 20, 22)

Selects an audio source. Each press cycles the audio sources as follows.

CD → USB → SERVER → NET RADIO → Back to CD

⑥ PURE DIRECT

Turns on or off PURE DIRECT mode. Audio quality will be improved when PURE DIRECT mode is on.



The PURE DIRECT indicator lights up when PURE DIRECT mode is on.

⑦ Disc tray

Loads a disc.

⑧ (Open/Close)

Opens or closes the disc tray.

⑨ Front panel display

Shows menu items, playback information, etc.



For details on display messages, see “Front panel display messages” (☞ P.29).

⑩ ▷/⏸ (Play/Pause)

Starts or pauses playback.

⑪ □ (Stop)

Stops playback.

⑫ ⏮/⏪ (Skip/Search backward)

⏩/⏭ (Skip/Search forward)

Skips back to the previous/beginning of the current track or to the next track, or searches backward/forward. Operations differ depending on audio sources.

⑬ SELECT/ENTER (jog dial) (☞ P.14, 16, 18, 21, 22, 24)

Rotate to select an item and press to confirm the selection.

⑭ RETURN (☞ P.14, 16, 21, 22)

Shows the upper-level menu in the front panel display.

Remote control

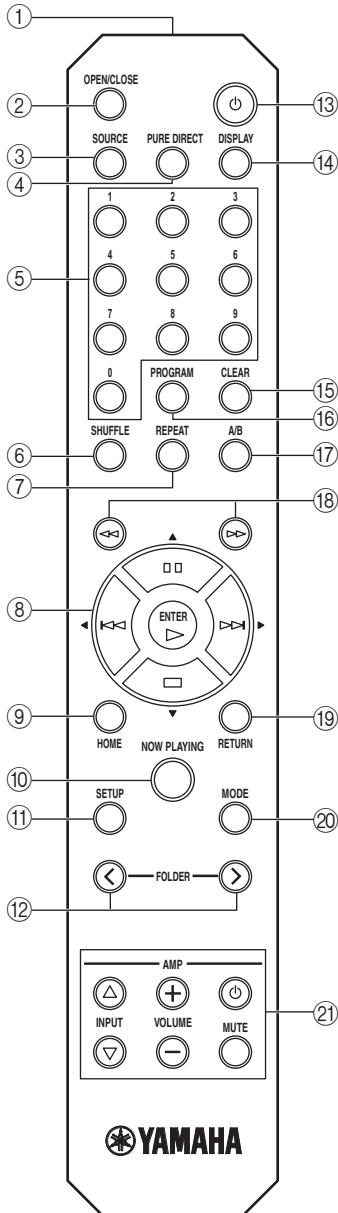

- ① **Remote control signal transmitter**
Transmits infrared signals to the main unit.
- ② **OPEN/CLOSE**
Opens or closes the disc tray.
- ③ **SOURCE** (☞ P.14, 16, 18, 20, 22)
Selects an audio source. Each press cycles the audio sources as follows.
CD → USB → SERVER → NET RADIO → Back to CD
- ④ **PURE DIRECT**
Turns on or off PURE DIRECT mode. Audio quality will be improved when PURE DIRECT mode is on.
- ⑤ **Numeric buttons** (☞ P.18)
Use to select directly a track on the disc or the current folder.
- ⑥ **SHUFFLE** (☞ P.15, 18, 21, 22)
Switches shuffle modes.
- ⑦ **REPEAT** (☞ P.15, 18, 21, 22)
Switches repeat modes.
- ⑧ **Playback buttons** (☞ P.14, 16, 18, 21, 22, 23)
 - ▶ (Play)
Starts playback.
 - (Stop)
Stops playback.
 - ⏸ (Pause)
Pauses playback.
 - ◀◀ (Skip backward)
Skips backward.
 - ▶▶ (Skip forward)
Skips forward.
 - ▲/▼/◀/▶ (Cursor buttons)/ENTER
Use the cursor buttons to select an item and press ENTER to confirm the selection.
- ⑨ **HOME** (☞ P.14, 16, 21, 22)
Shows the top-level menu in the front panel display.
- ⑩ **NOW PLAYING** (☞ P.15, 17, 21, 22)
Shows the playback information in the front panel display.
- ⑪ **SETUP** (☞ P.23)
Shows the setup menu in the front panel display.
- ⑫ **FOLDER (</>)** (☞ P.18)
Switches playback folders when playing music on data CDs.
- ⑬ **Power** (☞ P.10)
Switches this unit between on and standby mode.
☞
For details on standby mode, see “Front panel” (☞ P.5).
- ⑭ **DISPLAY** (☞ P.15, 17, 18, 21, 22)
Switches information shown in the front panel display, such as playback information.

15 CLEAR (☞ P.19)

Erases the last programmed track of an audio CD (except data CDs) during program editing mode.

16 PROGRAM

Turns on or off program playback mode. In program playback mode, you can playback tracks of an audio CD (except data CDs) in a programmed sequence. For details, see “Using program playback mode” (☞ P.19).

17 A/B

Repeats playback of a specified section of a track during audio CD playback (except data CDs). To set the starting and end points (A and B), press A/B twice during playback. To cancel the repeat A-B function, press A/B again.



- A data CD is defined as a disc in which MP3 or WMA files are recorded.
- You cannot set the repeat A-B function over two tracks.
- You cannot set the repeat A-B function for data CDs and USB devices.
- The repeat A-B function is canceled when (Stop) is pressed.
- You cannot set the repeat A-B function when this unit is in PURE DIRECT mode.
- You cannot set the repeat A-B function when the unit is showing the remaining playback time of the track or disc in the front panel display.

18 <<(Search backward), >>(Search forward)
(☞ P.18, 21)

Searches tracks backward/forward while the button is pressed and held during playback.

19 RETURN (☞ P.14, 16, 21, 22)

Shows the upper-level menu in the front panel display.

20 MODE (☞ P.21)

Switches between standard mode and extended mode when playing back your iPod.

21 Amplifier control buttons

Controls the corresponding functions of a Yamaha amplifier.

⏻ (Power)

Turns your amplifier on and off.

INPUT (Δ/▽)

Switches input sources.

VOLUME (+/-)

Adjusts the volume.

MUTE

Turns mute on or off.

For details on operations, refer to the manual of your amplifier.



These buttons may not work for some Yamaha amplifiers.

Rear panel

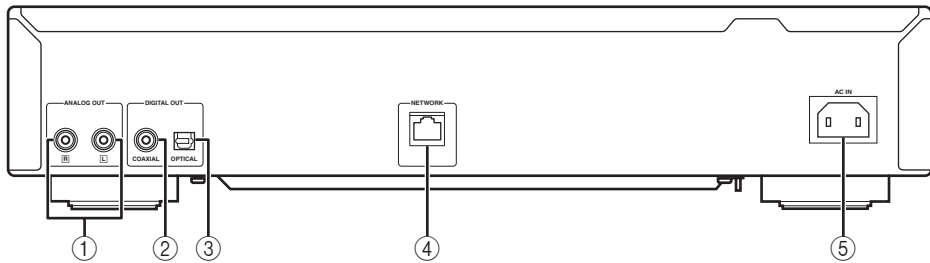

- ① **ANALOG OUT terminal (P.9)**
Outputs L/R analog audio signals. Connect to your amplifier or audio system using the RCA stereo cable (supplied).
- ② **DIGITAL OUT terminal (COAXIAL) (P.9)**
Outputs digital audio signals. Connect to your amplifier or audio system using a coaxial digital audio cable (commercially available).
- ③ **DIGITAL OUT terminal (OPTICAL) (P.9)**
Outputs digital audio signals. Connect to your amplifier or audio system using an optical cable (commercially available).
- ④ **NETWORK terminal (P.10)**
Connects to a network using a network cable (commercially available).
- ⑤ **AC IN socket (P.9)**
Connects to an AC outlet using the power cable (supplied).

CONNECTIONS

This section describes connections required before playing back with this unit.

Notes

- Do not connect the power cable of this unit until all connections are completed.
- You need to connect this unit to an amplifier and speakers before playing back.
- This unit can output digital signals up to 192 kHz/24 bits linear PCM signals.
- Proper playback may not be possible depending on the connected device and environment. Verify the settings and specifications of the connected playback source device.

Connecting to an amplifier

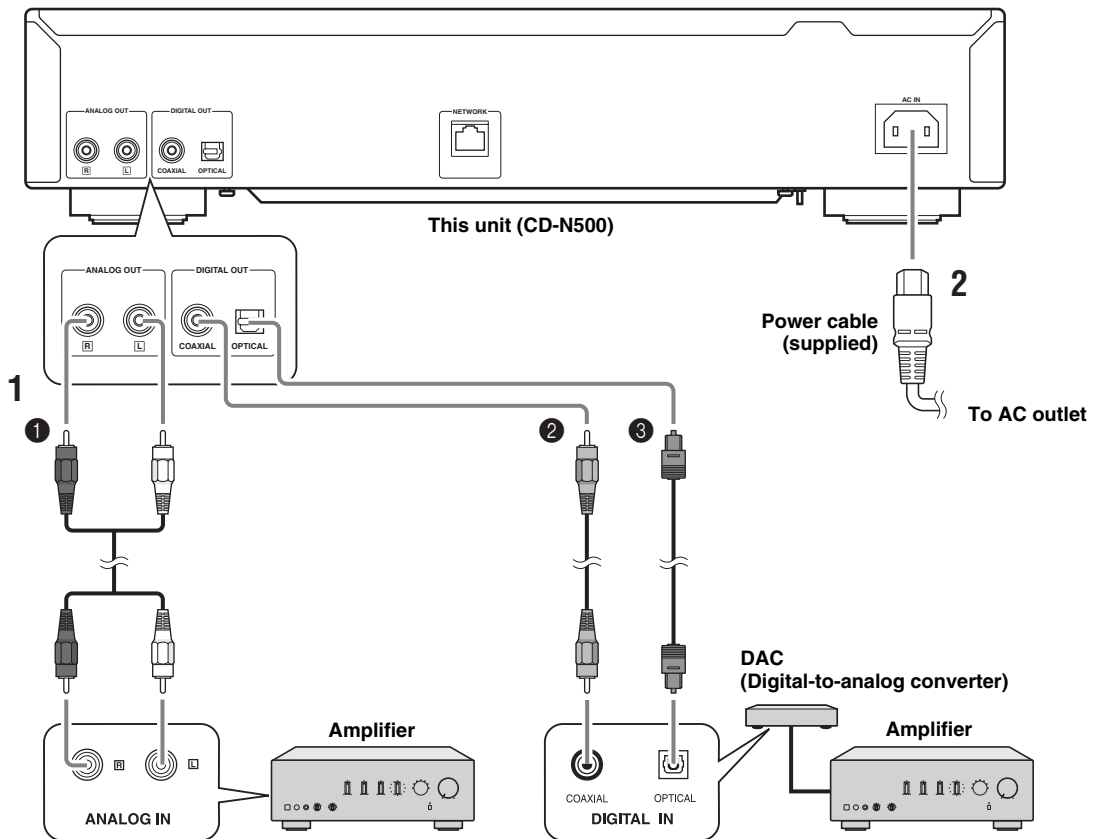

* The digital output is turned off when this unit is in PURE DIRECT mode.

1 Connect this unit to your amplifier with one of the following cables.

- ❶ RCA stereo cable (supplied)
- ❷ Coaxial digital audio cable (commercially available)
- ❸ Optical digital cable (commercially available)

2 Connect the supplied power cable to the AC IN socket, then plug into an AC outlet.



For details on speaker connections, refer to the manual of your amplifier or speakers.

Note

When using a digital connection, audio output may be interrupted at the beginning of a track depending on the audio system (amplifier, etc.).

Connecting to a network (PC/NAS/Internet connection)

You can play back music files stored on your PC or NAS, audio contents on the Internet, by connecting this unit to a network.
 Connect with a commercially available STP (shielded twisted pair) network cable (CAT-5 or higher, straight-through cable).

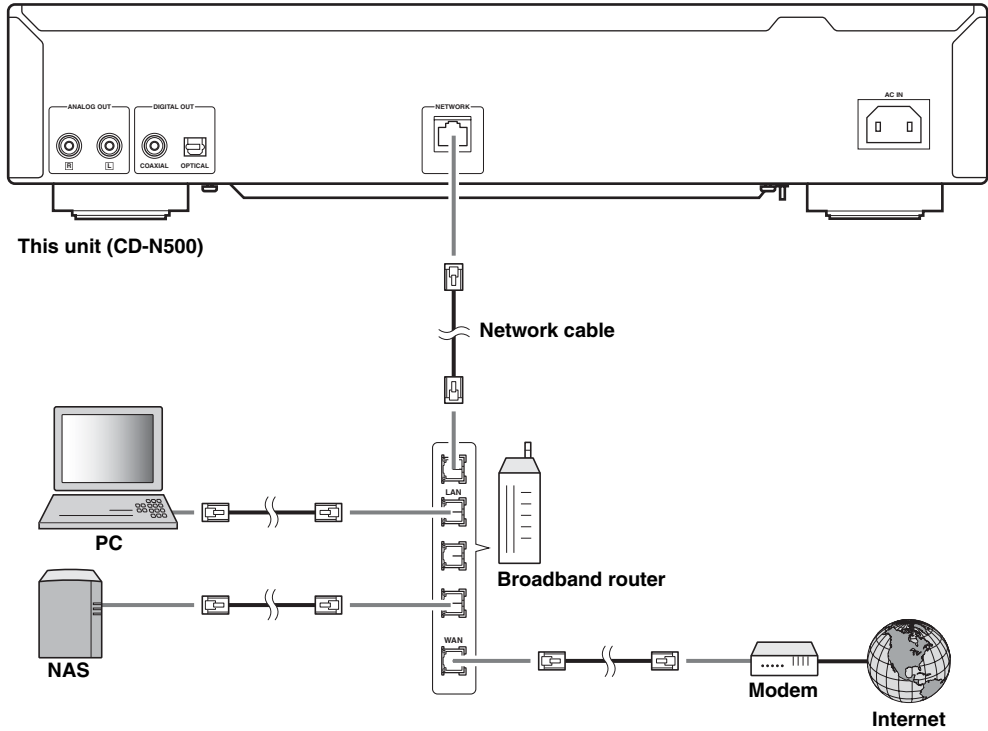

Notes

- All devices other than this unit are sold separately.
- You need to configure your PC or NAS after connecting. For details on settings, see “SETUP OF YOUR PC/NAS/MOBILE DEVICES” (P.11).
- Wired connections are recommended for each device to sustain high sound quality.

Turning on this unit

When you have established all cable connections, turn on this unit and other system components.

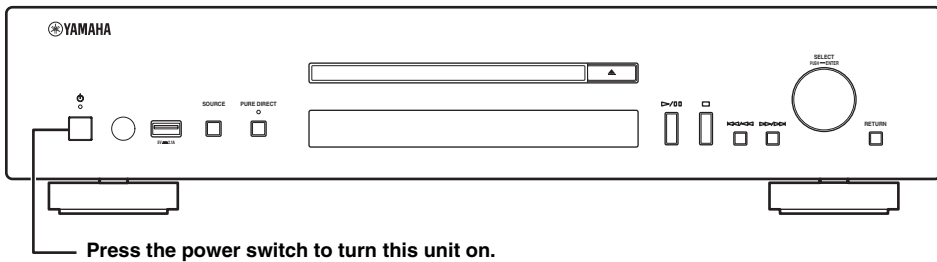

- With the power switch on, you can switch this unit to on or standby mode by pressing the power button on the remote control (P.6).
- For details on standby mode, see “Front panel” (P.5).

SETUP OF YOUR PC/NAS/MOBILE DEVICES

Configure your PC or NAS connected to the network to play back music files stored on the PC or NAS, or configure your mobile device to control this unit.



For details on Internet connection, please refer to the manual of your network devices.

■ Configuring your PC

What you want to do	Setup	Page
Play back music files stored on your PC 	You need to configure the media sharing setting of your PC. <ul style="list-style-type: none"> • Configure the media sharing setting of music files on Windows Media Player 12. 	12



You can operate from your PC using Windows Media Player. For details, refer to Windows Media Player help.

■ Configuring your NAS

What you want to do	Setup	Page
Play back music files stored on your NAS 	You need to configure the following settings to access your NAS. <ul style="list-style-type: none"> • Configure media sharing settings of your NAS. • Enable DHCP setting of your NAS.* Setup operations differ depending on your NAS. Refer to the NAS manual.	—

* In case that you use DHCP and automatically obtain necessary information for network, such as IP address. If you want to configure the network parameters manually, check that you are using an IP address which is not used by other network devices in your network.

■ Configuring your mobile device

What you want to do	Setup	Page
Operate this unit with your mobile device 	You need to download the dedicated application, and install it. <ul style="list-style-type: none"> • Enable DHCP setting of your mobile device.* 	13

* In case that you use DHCP and automatically obtain necessary information for network, such as IP address. If you want to configure the network parameters manually, check that you are using an IP address which is not used by other network devices in your network.

Sharing music files stored on your PC

To browse folders (directories) on your PC from this unit, you need to change the media sharing setting of Windows Media Player 12 or Windows Media Player 11 to make those folders accessible from this unit. For details on Windows Media Player, please refer to Windows Media Player help.



You can connect up to 16 media servers to this unit.

■ When using Windows Media Player 12 (on Windows 7)

- 1 Start Windows Media Player 12 on your PC.
- 2 Select “Stream”, then “Turn on media streaming”.

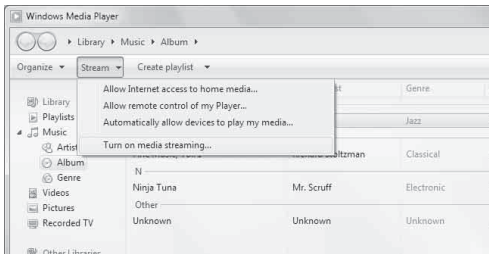

The Control Panel window of your PC appears.

- 3 Click “Turn on media streaming”.

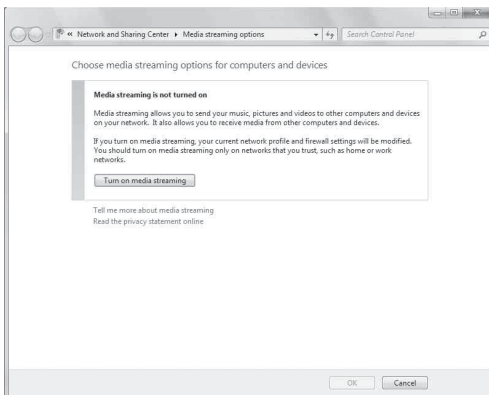

- 4 Select “Allowed” from the drop-down list next to “CD-N500”.

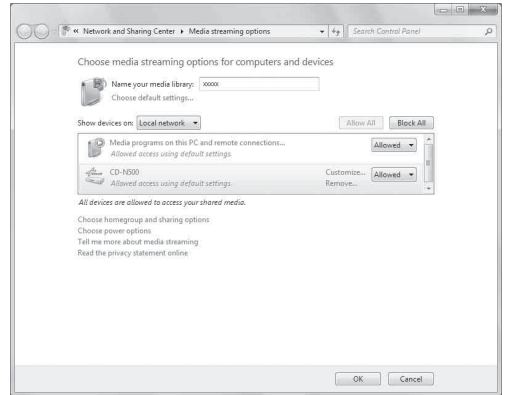

- 5 In the same way, select the icons for devices to be used as external media controllers (other PCs or mobile devices), then click “Allowed”.

- 6 Click “OK” to exit.

■ When using Windows Media Player 11

- 1 Start Windows Media Player 11 on your PC.
- 2 Select “Library” then “Media Sharing”.
- 3 Check the “Share my media to” box, select the “CD-N500” icon, then click “Allow”.
- 4 In the same way, select the icons for devices to be used as external media controllers (other PCs or mobile devices), then click “Allow”.
- 5 Click “OK” to exit.

Operations from your mobile device

You can operate this unit by viewing the screen of your mobile device.

■ Using the dedicated application

You can do the following operations from your mobile device using the dedicated application (free application).

- You can select and play back music files stored on your PC or NAS.
- You can select the Internet radio stations.
- You can operate playback of CDs and USB devices.



For configuring the PC or NAS settings, see “SETUP OF YOUR PC/NAS/MOBILE DEVICES” (P.11).

■ About the dedicated application

Download and install the dedicated application on your mobile device.

For details, please visit Yamaha website.

PLAYBACK OF MUSIC FILES ON YOUR PC/NAS

This section describes how to play back using the front panel buttons on the main unit, or the remote control.

Operations from the main unit or remote control



For details on the controls on the main unit or remote control, see "CONTROLS AND FUNCTIONS" (P.5).

1 Press SOURCE repeatedly to switch the audio source to "SERVER".

Main unit/Remote control

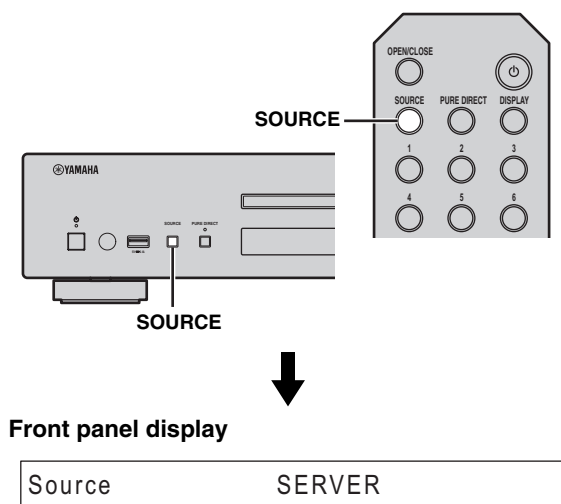

2 Use the following controls to select a menu item until you find a desired music file.

Main unit

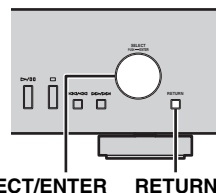

SELECT/ENTER (Jog dial)

Rotate to select a menu item and press to confirm the selection.

RETURN

Shows the upper-level menu in the front panel display.

Remote control

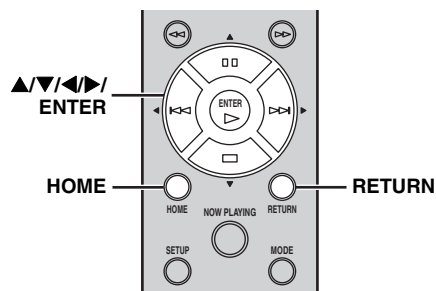

▲/▼/◀/▶ (Cursor buttons)/ ENTER

Press ▲/▼ to select a menu item (or press ◀/▶ to display the gauge indicating the current position of the content), then press ENTER to confirm the selection.

RETURN

Shows the upper-level menu in the front panel display.

HOME

Shows the top-level menu in the front panel display.

3 When playback starts, use the following controls to operate desired functions.

Main unit

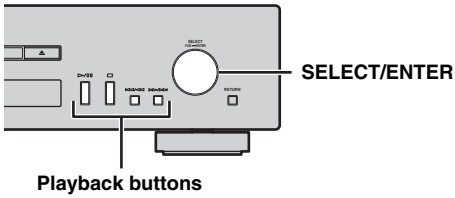

Remote control

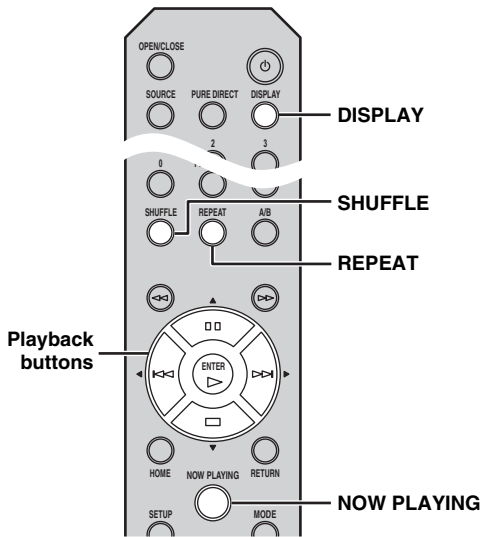

SELECT/ENTER (Jog dial)

Rotate while playing to skip to the next track, or back to the previous/beginning of the current track.

Playback buttons

Use these buttons to operate audio contents (☞ P.5, 6).

DISPLAY

If you press this button while a song is playing or paused, the information on the front panel display will be switched in the following order.

Song → Artist → Album → Time → Source
 ↑

SHUFFLE

Switches shuffle mode in the following order.

On → Off
 ↑

REPEAT

Switches repeat mode in the following order.

One → All → Off
 ↑

NOW PLAYING

Shows the current playback information in the front panel display.



- If the song being played is stopped, the track that you listened will start playback from the beginning of the track the next time you play.
- For details on playable files, see “PLAYABLE DISCS AND FILE FORMATS” (☞ P.31).

PLAYBACK OF AUDIO CONTENTS ON THE INTERNET

Listening to Internet radio stations

■ Operations from the main unit or remote control

- 1 Press **SOURCE** repeatedly to switch the audio source to “NET RADIO”.

Main unit/Remote control

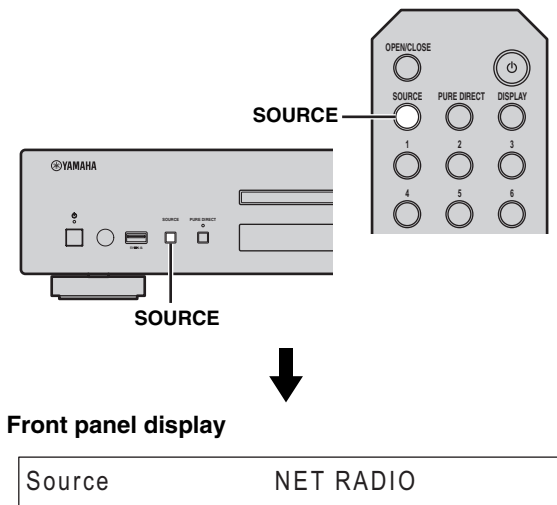

- 2 Use the following controls to select a menu item until you find a desired Internet radio station.

Main unit

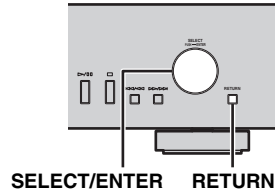

SELECT/ENTER (Jog dial)

Rotate to select a menu item and press to confirm the selection.

RETURN

Shows the upper-level menu in the front panel display.

Remote control

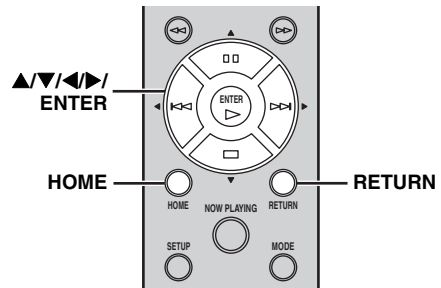

▲/▼/◀/▶ (Cursor buttons)/ ENTER

Press ▲/▼ to select a menu item (or press ◀/▶ to display the gauge indicating the current position of the content), then press ENTER to confirm the selection.

RETURN

Shows the upper-level menu in the front panel display.

HOME

Shows the top-level menu in the front panel display.

3 When playback starts, use the following controls to operate desired functions.

Main unit

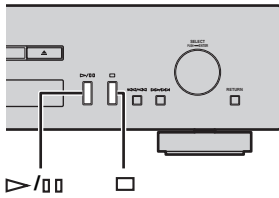

Remote control

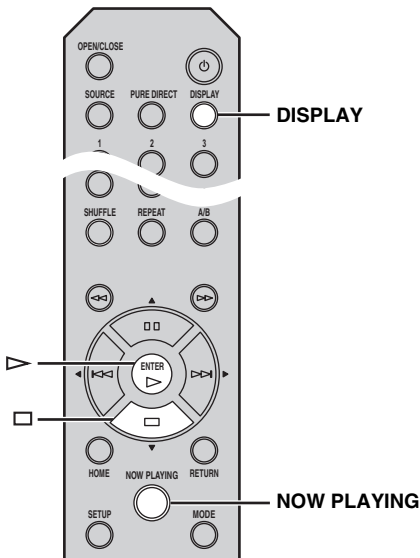

▷/□□ (Play/Pause) or ▷ (Play)

Starts playback.

□ (Stop)

Stops playback.

DISPLAY

If you press this button while a song is playing or paused, the information on the front panel display will be switched in the following order.

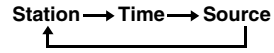

NOW PLAYING

Shows the current playback information in the front panel display.



You can register and bookmark your favorite Internet radio stations by accessing the “vTuner Radio Guide” website. To use this feature, you need the MAC address of this unit (P.24) as the ID for your Media player and your e-mail address to create your personal account.

For details, visit the website below.

<http://yradio.vtuner.com/>

PLAYBACK OF CDS

Playing back a CD

- 1 Press **SOURCE** repeatedly to switch the audio source to "CD".

Main unit/Remote control

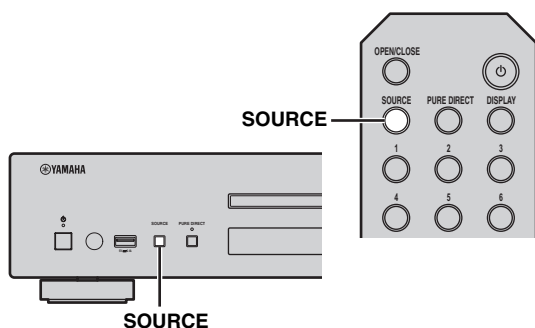

Front panel display



- 2 Press \triangle (Open/Close) on the main unit to open the disc tray, then load a CD.

- 3 Press \triangle (Open/Close) again to close the disc tray.
Playback automatically starts.

- 4 When playback starts, use the following controls to operate desired functions.

Main unit

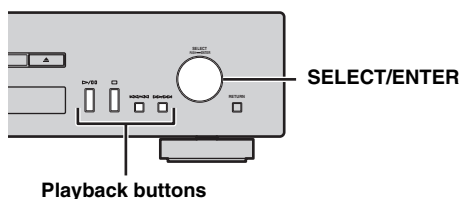

Remote control

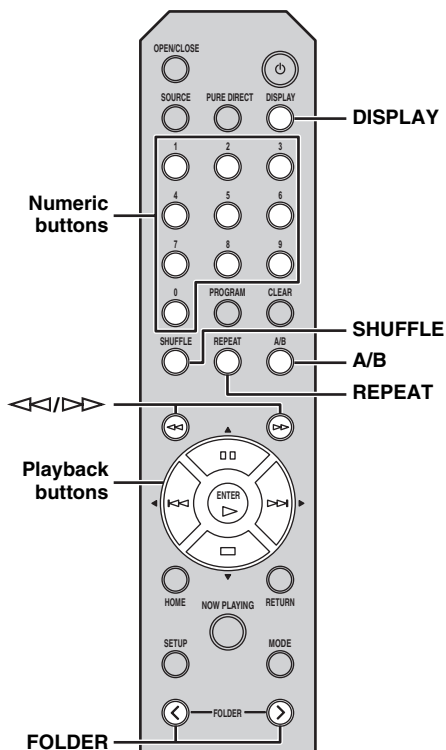

SELECT/ENTER (Jog dial)

Rotate while playing to skip to the next track, or back to the previous/beginning of the current track.

Playback buttons

Use these buttons to operate audio contents (P.5, 6).

Numeric buttons (Audio CD only)

Use to select directly a track on the CD.

\lll (Search backward)/ \ggg (Search forward)

Searches backward/forward.

FOLDER (\langle/\rangle) (Data CD only)

Selects the desired folder.

DISPLAY

If you press this button while a song is playing or paused, the information on the front panel display will be switched in the following order.

Audio CD:

Time → (Song) → (Artist) → (Album) → Source



- “Time” cycles through the three steps as follows each time you press this button.
 - Track number and elapsed playback time.
 - Track number and remaining playback time of the track.
 - Remaining playback time of the disc.
- “Song”, “Artist” and “Album” are shown only if text information is included in the disc.

Data CD:

Time → Song → Artist → Album → Source

SHUFFLE

Switches shuffle mode to “Folder”, “All” and “Off” as follows.

Audio CD:

All → Off

Data CD:

Folder → All → Off

A/B (Audio CD only)

Repeats playback of a specified section of a track during audio CD playback (except data CDs) (☞ P.7).

REPEAT

Switches repeat mode in the following order.

Audio CD:

One → All → Off

Data CD:

One → Folder → All → Off



- If the song being played is stopped, the track that you listened will start playback from the beginning of the track the next time you play.
- If you press □ (Stop) while playback is stopped, the first track of the CD you listened will start playback the next time you play.
- For details on playable discs and files, see “PLAYABLE DISCS AND FILE FORMATS” (☞ P.31).

Using program playback mode

In program playback mode, you can play back tracks in a programmed sequence.

1 Press PROGRAM on the remote control while playback is stopped.

This unit enters program editing mode.

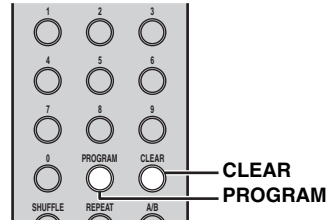
**2 Select a track by using the numeric buttons and press ENTER to confirm.****3 Repeat step 2 to program the next track.**

You can program up to 50 tracks.



To cancel the programmed track, press CLEAR during program editing mode. The last programmed track will be deleted.

4 Press ▷/⏸ (Play/Pause) on the main unit or ▷ (Play) on the remote control.

Playback starts from the beginning of the programmed sequence.



- To erase all programmed tracks, press CLEAR while playback is stopped.
- You cannot set a program playback for data CDs.

Note

The programmed tracks are erased when the disc is ejected or this unit is turned off.

PLAYBACK OF YOUR iPod/USB DEVICES

Connecting your iPod or USB devices

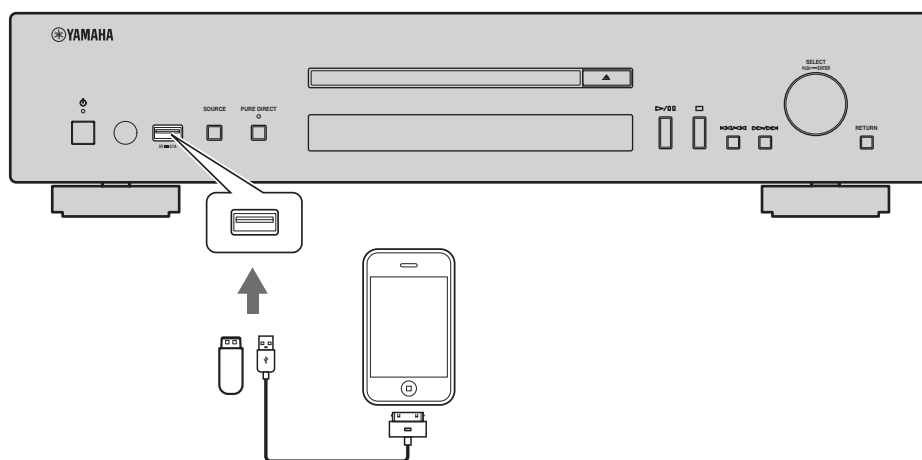

- Connect your iPod using the USB cable supplied with your iPod.
- Remove a USB device after you stop playback.
- Do not use a USB hub. This unit does not recognize a USB device if the USB device is connected via a USB hub.

Playing back your iPod

- 1 Press **SOURCE** repeatedly to switch the audio source to “USB”.

Main unit/Remote control

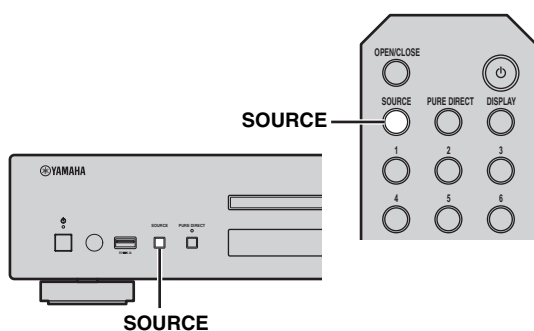

Front panel display



- 2 Connect your iPod to the USB port on the main unit.

- 3 Start playback on your iPod.

Operate your iPod to start playback, select a track, pause, and stop playback (standard playback mode).



- You can also operate to play, pause, stop, skip forward/backward, and search forward/backward from the playback buttons on the main unit and remote control during standard playback mode.

Main unit:

▷/□□, □, ◀◀/◀◀, ▶▶/▶▶

Remote control:

▷, □□, □, ▶▶, ◀◀, ▶▶, ◀◀

- You cannot operate shuffle and repeat modes from your iPod and the remote control during standard playback mode.

Note

iPod may not function properly with this unit if software on iPod is not updated. Be sure to use the latest version of iPod software. For details on supported iPod, see “Supported iPod via USB port” (P.31).

Using extended playback mode for your iPod

You can operate your iPod from the main unit or remote control in extended mode.

1 Press MODE on the remote control while playing back your iPod.

It switches to extended playback mode.

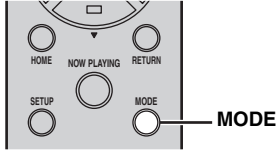

2 Use the following controls to operate desired functions.

Main unit

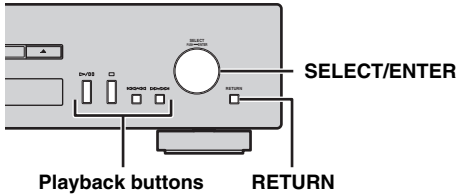

Remote control

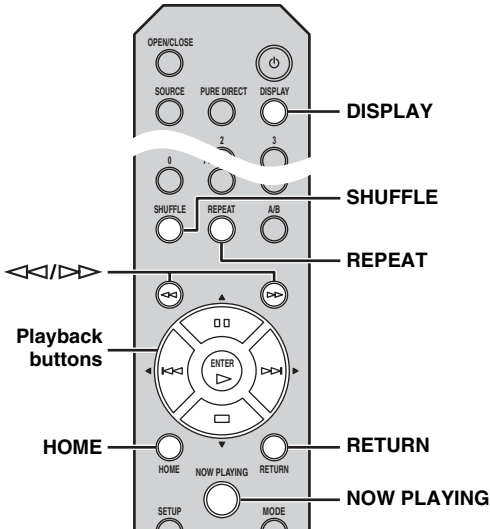

SELECT/ENTER (Jog dial)

Rotate while playing to skip to the next track, or back to the previous/beginning of the current track.

Playback buttons*

Use these buttons to operate audio contents (P.5, 6).

RETURN

Shows the upper-level menu in the front panel display.

◀◀ (Search backward)/▶▶ (Search forward)*
Searches backward/forward.

HOME

Shows the top-level menu in the front panel display.

DISPLAY

If you press this button while a song is playing or paused, the information on the front panel display will be switched in the following order.

Song → Artist → Album → Time → Source
↑

SHUFFLE*

Switches shuffle mode of your iPod.

Songs → Albums → Off
↑

REPEAT*

Switches repeat mode in the following order.

One → All → Off
↑

NOW PLAYING

Shows the current playback information in the front panel display.

* Operations differ depending on your iPod.



Playable file formats via iPod depends on your iPod.

Playing back USB devices

1 Press SOURCE on the main unit or remote control to switch the audio source to “USB” (P.20).

2 Connect your USB device to the USB port on the main unit.

File name is displayed in the front panel display and playback starts automatically in order by date and time of creation if playable files are in the USB device.

3 When playback starts, use the following controls to operate desired functions.

Main unit

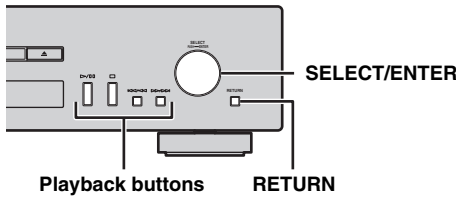

Remote control

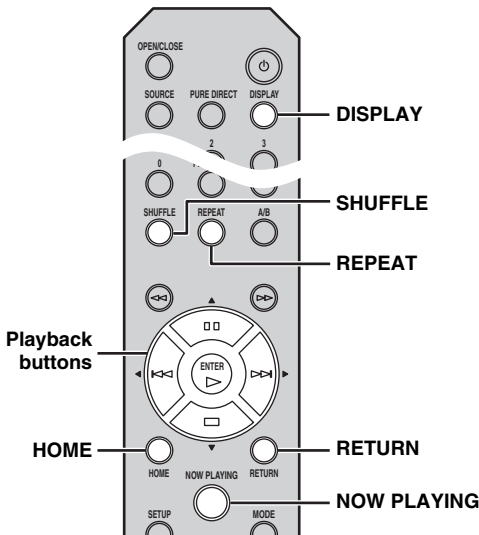

SELECT/ENTER (Jog dial)

Rotate while playing to skip to the next track, or back to the previous/beginning of the current track.

Playback buttons

Use these buttons to operate audio contents (P.5, 6).

RETURN

Shows the upper-level menu in the front panel display.

HOME

Shows the top-level menu in the front panel display.

DISPLAY

If you press this button while a song is playing or paused, the information on the front panel display will be switched in the following order.



SHUFFLE

Switches shuffle mode in the following order.

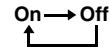

REPEAT

Switches repeat mode in the following order.

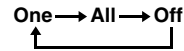

NOW PLAYING

Shows the current playback information in the front panel display.



- If the song being played is stopped, the track that you listened will start playback from the beginning of the track the next time you play.
- For details on playable files, see “PLAYABLE DISCS AND FILE FORMATS” (P.31).

SETUP MENU

You can configure the various settings of this unit using the setup menu.

Setup menu operations

Operations from the remote control



For details on the controls on the main unit or remote control, see "CONTROLS AND FUNCTIONS" (P.5).

1 Press SETUP to enter the setup menu (P.24).

To make the advanced setup menu items (P.25) selectable, press SETUP while holding down RETURN (on the main unit).

Remote control

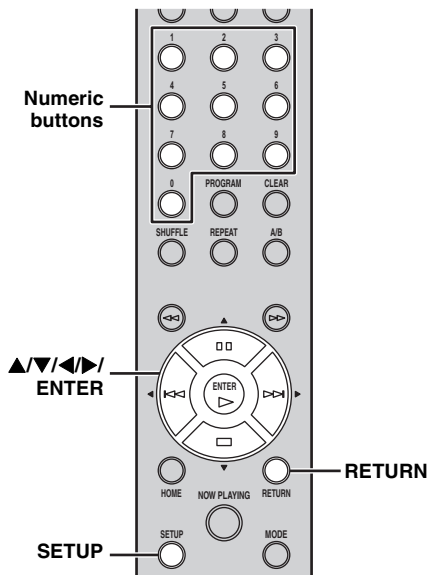

Main unit

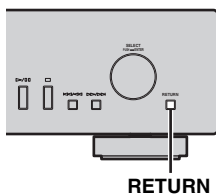

Front panel display



2 Press ▲/▼ to select a menu item to configure, then press ENTER.

For some menu items, repeat step 2 to select a submenu item.



3 Press ▲/▼ to select a parameter, then press ENTER.



You need to enter a numerical address for some menu items. In this case, press ◀/▶ to move the target and ▲/▼ to select a number, or use the numeric buttons. Then press ENTER to confirm it.



Setup menu list

Menu	Submenu	Settings (Bold: default)	Function
Network Configuration	DHCP	On , Off	Select “On” to use the DHCP server to automatically configure the network settings of this unit or “Off” to configure manually.
	IP Address		Specify the IP address when “DHCP” is “Off”. *1
	Subnet Mask		Specify the subnet mask when “DHCP” is “Off”. *1
	Default Gateway		Specify the default gateway when “DHCP” is “Off”. *1
	DNS Server (P)		Specify the primary DNS server when “DHCP” is “Off”. *1
	DNS Server (S)		Specify the secondary DNS server when “DHCP” is “Off”. *1
Network Information	MAC Address		The MAC address of this unit is shown. The MAC address is also used as a vTuner ID.
	Status		The network status of this unit is shown (“Connected” or “Not connected”).
	System ID		The system ID number is shown.
Network Standby		On , Off	Select “On” to enable the network standby mode.
Auto Power Down		4 Hours, 8 Hours, 12 Hours, Off	This unit automatically enters standby mode if it is left turned on for the selected time without playback or any other operation being performed.
Dimmer		-3 to 0	Adjust the brightness of the front panel display.
Firmware Version			The firmware version of this unit is shown.
Firmware Update		Network , USB	Update the firmware of this unit after selecting “Network” or “USB”. When “Press ENTER to start” appears, press ENTER to start firmware update. Do not operate this unit until “UPDATE SUCCESS” appears. Then turn off this unit once and turn it on again.

*1: When “DHCP” is “On”, you can check the values (IP address, etc.) assigned by the DHCP server.

Advanced setup menu

The following menu items are available only when you enter the setup menu by pressing SETUP (on the remote control) while holding down RETURN (on the main unit).

Menu	Settings (Bold: default)	Function
MAC Address Filter	On, Off	Select "On" to specify the MAC addresses (up to 5) of the network components that will be permitted access to this unit ("Address1" to "Address5"). Select "Off" to disable the MAC address filter function.
Gapless Playback	On , Off	Select "On" to skip silence between each track and enable seamless playback. Select "Off" to disable the gapless playback function. This function works on "SERVER" audio contents only.  When "Gapless Playback" is "On", this unit starts to read data of the next track at the end of the current track. Some playback operations (skip, repeat, etc.) will work on the next track during this process.
vTuner Account Reset	Yes, No	Select "Yes" and press ENTER on the remote control to reset the vTuner account.  <ul style="list-style-type: none"> • If you reset your vTuner account, your user name, password and bookmarks will be reset. • To create a new account, visit the website below. http://yradio.vtuner.com/ You need the MAC address of this unit as the ID for your Media player and your e-mail address.
Initialize	Yes, No	Select "Yes" to reset the settings of this unit to factory default. The reset operation will be reflected the next time you turn on this unit.

TROUBLESHOOTING

Refer to the table below when this unit does not function properly. If the problem you are experiencing is not listed below or if the instruction below does not help, turn off this unit, disconnect the power cable, and contact the nearest authorized Yamaha dealer or service center.

■ General

Problem	Cause	Remedy	Page
This unit fails to turn on.	The power cable is not connected to the AC IN socket on the main unit or not plugged into an AC outlet.	Connect the power cable firmly.	9
	This unit has been exposed to a strong external electric shock (such as lightning or strong static electricity).	Turn off this unit, disconnect the power cable, plug it back in after 30 seconds, then use it normally.	—
	The protection circuitry has been activated three times consecutively. When this unit is in this condition, the power indicator on the main unit blinks if you try to turn on the power.	As a safety precaution, capability to turn on the power is disabled. Contact your nearest Yamaha dealer or service center to request repair.	—
The power indicator on the front panel flashes.	There is a problem with the internal circuitries of this unit.	Turn off this unit, disconnect the power cable, then contact the nearest authorized Yamaha dealer or service center.	—
This unit suddenly turns off.	This unit entered standby mode.	This unit enters standby mode after the time set for “Auto Power Down” in the setup menu has elapsed.	24
No sound.	The audio cable connection between this unit and amplifier is improper.	Connect the audio cable firmly. If the problem persists, use another audio cable.	9
	The input setting on the amplifier is incorrect.	Select the correct input (from this unit) on the amplifier.	—
	The amplifier is not compatible with the digital signals.	Use an analog signal connection.	9
Noise is heard.	This unit is too close to the digital or radio-frequency equipment.	Move this unit away from such equipment.	—
	The audio cable between this unit and the media server is defective.	Connect the audio cable firmly. If the problem persists, use another audio cable.	—

Problem	Cause	Remedy	Page
The remote control does not work or function properly.	Wrong distance or angle.	The remote control functions within a maximum range of 6 m (20 ft) and no more than 30 degrees off-axis from the front panel of the main unit.	4
	Direct sunlight or lighting is striking the remote control sensor of this unit.	Adjust the lighting angle, or reposition this unit.	—
	The batteries are weak.	Replace both batteries with new ones.	4
The amplifier control buttons on the remote control do not work on the amplifier.	Your amplifier is not one of Yamaha amplifiers. (These buttons may not work on some Yamaha amplifiers.)	Use the remote control of your amplifier.	—

■ Network

Problem	Cause	Remedy	Page
The network feature does not function.	The network parameters (IP address) have not been obtained properly.	Enable the DHCP server function on the broadband router and set "DHCP" in the setup menu to "On" on this unit. If you want to configure the network parameters manually, check that you are using an IP address which is not used by other network devices in your network.	24
This unit does not detect the digital media server (PC).	The media sharing setting is not correct.	Configure the media sharing setting of your PC.	11
	Some security software installed on your PC is blocking the access of this unit to your PC.	Check the settings of security software installed on your PC.	—
	This unit and your PC are not in the same network.	Check the network connections and the broadband router settings, then connect this unit and your PC to the same network.	10
	Access to this unit is restricted by MAC address filter function	Disable MAC address filter function in the setup menu of this unit.	24
	There are more than two routers in use that are overlapping among the network devices.	Disconnect the Internet connection temporarily and check via your local network, or connect the network devices you want to use to the same router.	—

Problem	Cause	Remedy	Page
The files in your PC cannot be viewed or played back.	The files are not supported by this unit or the media server.	Use the file format supported by both this unit and the media server. For details on the supported file formats by the unit, see “PLAYABLE DISCS AND FILE FORMATS”.	31
Some audio files cannot be played back on this unit.	You are trying to play back DRM audio files you purchased on iTunes Store.	You cannot play back DRM audio files you purchased on iTunes Store.	31

■ Audio contents on the Internet

Problem	Cause	Remedy	Page
The Internet radio cannot be played.	The selected Internet radio station is currently not available.	There may be a network problem at the radio station, or the service may have been stopped. Try the station later or select another station.	—
	The selected Internet radio station is currently broadcasting silence.	Some Internet radio stations broadcast silence at certain of times of the day. Try the station later or select another station.	—
	Access to the network is restricted by the firewall settings of your network devices (such as the broadband router).	Check the firewall settings of your network devices. The Internet radio can be played only when it passes through the port designated by each radio station. The port number varies depending on the radio station.	—

■ CD

Problem	Cause	Remedy	Page
The disc tray does not close completely.	A foreign object is obstructing the tray.	Carefully check the disc tray and remove the foreign object.	—
Disc playback does not start.	The disc is damaged.	Check the disc carefully and replace it if necessary.	—
	There is moisture on the laser pickup.	Wait 20 to 30 minutes after turning this unit on before trying to play back a disc.	—
	The disc is loaded upside down.	Reload the disc with the label side up.	—
	The disc is dirty.	Clean the disc.	32
	The format of the MP3 or WMA file is not compatible with this unit.	Replace the disc with a correctly recorded disc playable with this unit.	31

Problem	Cause	Remedy	Page
Disc playback does not start.	The CD-RW (ReWritable) disc is not recorded correctly.	Replace the disc with a correctly recorded disc playable with this unit.	31
	The disc is a non-standard disc not playable with this unit.	Replace the disc with a correctly recorded disc playable with this unit.	31
Playback is delayed, or begins at the wrong place.	The disc is scratched or damaged.	Check the disc carefully and replace it if necessary.	32
Noise from inside of the disc tray.	The disc is warped.	Replace the disc.	—

■ iPod/USB

Problem	Cause	Remedy	Page
iPod playback does not start though iPod is connected.	The connected iPod is not compatible with this unit.	Connect an iPod compatible with this unit.	31
USB playback does not start.	The USB device is not connected properly.	Connect the USB device again.	20
	The format of the MP3 or WMA file is not compatible with this unit.	Replace the file with a correctly recorded file playable with this unit.	31
	This unit is set to an audio source than "USB".	Press SOURCE on the main unit or remote control to switch the audio source to "USB".	22

Front panel display messages

Message	Status
Access error	This unit cannot access the USB device.
	This unit cannot access the iPod.
	The connected iPod is not supported by the unit.
	There is a problem with the signal path from the network to the unit.
Unable to play	This unit cannot play back specified content.
List updated	The content list of the media server has been updated.
No content	This unit cannot find any content.
Not available	The operation you have performed is not available.
Searching...	This unit is searching for content.
No disc	A CD is not inserted in the disc tray.
Connect error	Connection to your iPod or USB device failed.
No device	Your iPod or USB device is not connected.
USB overloaded	An overcurrent is flowing through the USB device.
Loading...	The specified content is being loaded.
Unknown iPod	The connected iPod is not compatible.

ADDITIONAL INFORMATION

This section describes about general ideas of DLNA (Digital Living Network Alliance) and NAS (Network Attached Storage).

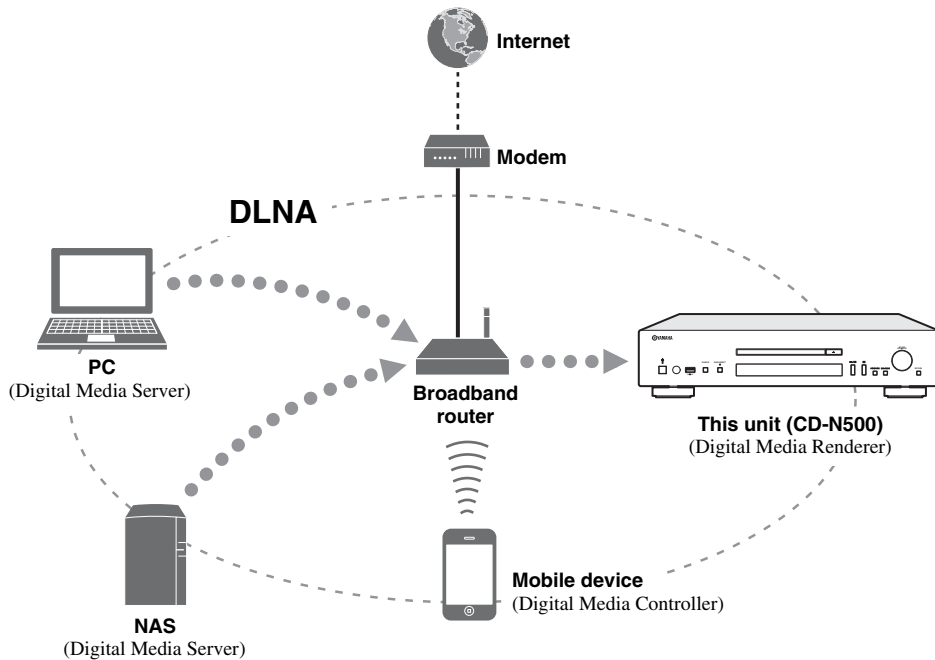

■ DLNA

“DLNA” stands for Digital Living Network Alliance, and is a guideline to promote standardization of interconnection of home network devices such as digital consumer electronics.

DLNA components are separated into four device classes: Digital Media Server (DMS), Digital Media Renderer (DMR), Digital Media Player (DMP) and Digital Media Controller (DMC).

“Digital Media Server (DMS)” is a device that is used to store or distribute digital contents such as music files. For the system using this unit, PCs and NAS are regarded as “Digital Media Server (DMS)”.

“Digital Media Controller (DMC)” is a device to control digital contents. The dedicated mobile device application corresponds to “Digital Media Controller (DMC)” for the system using this unit.

“Digital Media Renderer (DMR)” is a device to receive instructions from “Digital Media Controller (DMC)” and play back digital contents such as this unit.

Similarly, “Digital Media Player (DMP)” is a device that can play back digital contents stored on “Digital Media Server (DMS)”.

■ NAS

“NAS” stands for Network Attached Storage. By connecting your NAS and home network with a network cable directly, NAS can be a storage device, such as a hard disc drive. If your NAS is compatible with DLNA, you can share your music, pictures, or movies on the same home network as a digital media server.

PLAYABLE DISCS AND FILE FORMATS

Playable media and devices

■ Supported PC

PC with Windows Media Player 11 or Windows Media Player 12 installed.

■ Supported NAS

NAS that is compatible with DLNA version 1.5.

■ Supported USB devices

Device	Class/Protocol	File formats
USB memory devices	MSC (Mass Storage Class)	FAT16/32
USB audio player	MSC (Mass Storage Class)	FAT16/32

Notes

- Some devices may not work properly even if they meet the requirements.
- This unit does not support encrypted USB memory devices.
- Do not connect devices other than USB mass storage class devices: USB chargers, USB hubs, PCs, external HDD, etc.
- Yamaha and suppliers accepts no liability for the loss of data saved on the USB devices connected to this unit. It is recommended that the files are made backup copies.
- Playability of and power supply to all kinds of USB devices are not guaranteed.

■ Supported iPod via USB port

iPod	iPhone	iPad
iPod touch, iPod nano (2nd through 6th generations)	iPhone, iPhone 3G, iPhone 3GS, iPhone 4, iPhone 4S	iPad, iPad 2, iPad (3rd generation)

* As of August 2012

Notes







- iPod is licensed on the condition that individuals perform privately duplication and playback of uncopyrighted material or material legally approved of duplication and playback. Infringement of copyright is prohibited by law.
- Yamaha and suppliers accepts no liability for the loss of data saved on iPod connected to this unit. It is recommended that the files are made backup copies.

■ Supported mobile devices

For details, please visit Yamaha website.

■ Playable discs

Use compact discs bearing the marks below.

Mark	Details
	Compact discs (digital audio)
   	<p>CD-R, CD-RW digital audio discs</p> <ul style="list-style-type: none"> • CD-R or CD-RW discs bearing one of the following phrases. FOR CONSUMER FOR CONSUMER USE FOR MUSIC USE ONLY • Finalized CD-R or CD-RW discs only. <p>Note</p> <p>This unit may not be able to play some CD-R/CD-RW discs or discs on which recording was not made correctly.</p>
	<p>CD-TEXT discs</p> <p>The disc title, artist name, and track name are also displayed in addition to the time displays when playing back a CD with CD TEXT.</p>

To play back an 8-cm (3-inch) CD

Place it in the inner recessed area of the disc tray. Do not put a normal 12-cm (5-inch) CD on top of an 8-cm (3-inch) CD.

Notes

- Do not use any nonstandard shaped disc (heart, etc.) available on the market because it might damage the unit.
- Do not use a disc with tape, stickers, or paste on it. If you use such a disc, the disc may get stuck in the unit, or damage to the unit may result.



■ About handling discs

- Always handle with care so that the playing surface is not scratched. Do not warp discs.



- To keep clean the playing surface, wipe with a clean, dry cloth. Do not use any type of disc cleaner, spray, or any other chemical-based liquid.
- Do not wipe with a circular motion; wipe straight outward from the center.

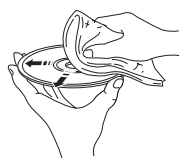

- Use a soft-tipped pen when writing on the label side of the disc.
- When a disc is not being used, remove it from this unit and store in an appropriate case.
- Do not expose discs to direct sunlight, high temperature or high humidity for a long time.

Note

Do not use any lens cleaners as they may be a cause of malfunction.

Playable discs and file formats

■ DLNA/USB

Formats	Sampling frequency (kHz)	Quantization bit
WAV *1	8 to 192	16/24
MP3 *2	8 to 48	16
WMA *3	8 to 48	16
AAC	8 to 48	16
FLAC	8 to 192	16/24
ALAC *4	44.1 to 48	16

*1 Only Linear PCM format files are playable.

*2 MP3 PRO files are not supported.

*3 WMA PRO and Lossless files are not supported.

*4 ALAC stands for Apple Lossless Audio Codec.



- Playable file formats via iPod depends on your iPod.
- Files recorded with multi-channels are not supported.
- Playback for USB starts in order by date and time of creation.

■ Discs

Formats	Sampling frequency (kHz)	Quantization bit
MP3	8 to 48	16
WMA	16 to 48	16

Notes

- Playback for MP3 or WMA files starts in alphanumeric order.
- Copyright-protected WMA (DRM) files cannot be played back by this unit.
- The disc must be ISO 9660 compatible.
- Elapsed time may not be displayed correctly while playing back variable bitrate contents.

SPECIFICATIONS

INPUT/OUTPUT

- NETWORK
 - Ethernet connection100Base-TX/10Base-T
 - DLNA version1.5
- ANALOG OUT2ch (L/R)
- DIGITAL OUT
 - Optical × 1
 - Coaxial × 1
- USB × 1

AUDIO SECTION

- Output level
 - 1 kHz, 0 dB, fs 44.1 kHz2.0 ± 0.3 V
- Signal to noise ratio (IHF-A network)
 - 1 kHz, 0 dB, fs 44.1 kHz 110 dB or more
- Dynamic range
 - 1 kHz, 0 dB, fs 44.1 kHz 100 dB or more
- Harmonic distortion
 - 1 kHz, 0 dB, fs 44.1 kHz0.003% or less
- Frequency response (CD)
 - fs 44.1 kHz2 Hz to 20 kHz, -3 dB
- (NETWORK)
 - fs 48 kHz2 Hz to 24 kHz, -3 dB
 - fs 96 kHz2 Hz to 48 kHz, -3 dB
 - fs 192 kHz2 Hz to 96 kHz, -3 dB

GENERAL

- Power supply
 - [Europe model] AC 230-240 V, 50 Hz
 - [U.S.A and Canada models]AC 120 V, 60 Hz
 - [Asia model]AC 110-120/220-240 V, 50/60 Hz
 - [Australia model] AC 230-240 V, 50 Hz
 - [China model]AC 220 V, 50 Hz
- Power consumption28 W
- Standby power consumption when network standby mode is enabled (reference data).....3.5 W
- Standby power consumption when network standby mode is disabled (reference data).....0.35 W
- Dimensions (W × H × D).....435 × 96 × 313.3 mm
(17-1/8 × 3-3/4 × 12-1/3 in)
- Weight.....5.25 kg (11.6 lb)

* Please note that all specifications are subject to change without notice.

iPod, iPhone, iPad

iPad, iPhone, iPod, iPod nano, and iPod touch are trademarks of Apple Inc., registered in the U.S. and other countries.

“Made for iPod,” “Made for iPhone,” and “Made for iPad” mean that an electronic accessory has been designed to connect specifically to iPod, iPhone, or iPad, respectively, and has been certified by the developer to meet Apple performance standards. Apple is not responsible for the operation of this device or its compliance with safety and regulatory standards. Please note that the use of this accessory with iPod, iPhone, or iPad may affect wireless performance.

Android™ is a trademark of Google Inc.

Windows™

Windows is a registered trademark of Microsoft Corporation in the United States and other countries.

Windows XP, Windows Vista, Windows 7, Windows Media Audio and Windows Media Player are either registered trademarks or trademarks of Microsoft Corporation in the United States and/or other countries.



DLNA™ and DLNA CERTIFIED™ are trademarks or registered trademarks of Digital Living Network Alliance. All rights reserved. Unauthorized use is strictly prohibited.



Fraunhofer Institut Integrierte Schaltungen

MPEG Layer-3 audio coding technology licensed from Fraunhofer IIS and Thomson.

■ Information about software

This product uses the following free software.
For information (copyright, etc) about each software, read the original sentences stated below.

About The Independent JPEG Group's JPEG software

The Independent JPEG Group's JPEG software

Copyright © 1991-2010, Thomas G. Lane, Guido Vollbeding.
All Rights Reserved except as specified below.

The authors make NO WARRANTY or representation, either express or implied, with respect to this software, its quality, accuracy, merchantability, or fitness for a particular purpose. This software is provided "AS IS", and you, its user, assume the entire risk as to its quality and accuracy.

Permission is hereby granted to use, copy, modify, and distribute this software (or portions thereof) for any purpose, without fee, subject to these conditions:

- (1) If any part of the source code for this software is distributed, then this README file must be included, with this copyright and no-warranty notice unaltered; and any additions, deletions, or changes to the original files must be clearly indicated in accompanying documentation.
- (2) If only executable code is distributed, then the accompanying documentation must state that "this software is based in part on the work of the Independent JPEG Group".
- (3) Permission for use of this software is granted only if the user accepts full responsibility for any undesirable consequences; the authors accept NO LIABILITY for damages of any kind.

These conditions apply to any software derived from or based on the IJG code, not just to the unmodified library. If you use our work, you ought to acknowledge us.

Permission is NOT granted for the use of any IJG author's name or company name in advertising or publicity relating to this software or products derived from it. This software may be referred to only as "the Independent JPEG Group's software".

We specifically permit and encourage the use of this software as the basis of commercial products, provided that all warranty or liability claims are assumed by the product vendor.

About PNG Reference Library

libpng versions 1.2.6, August 15, 2004, through 1.4.5, December 9, 2010, are Copyright © 2004, 2006-2010 Glenn Randers-Pehrson, and are distributed according to the same disclaimer and license as libpng-1.2.5 with the following individual added to the list of Contributing Authors
Cosmin Truta

libpng versions 1.0.7, July 1, 2000, through 1.2.5 - October 3, 2002, are Copyright © 2000-2002 Glenn Randers-Pehrson, and are distributed according to the same disclaimer and license as libpng-1.0.6 with the following individuals added to the list of Contributing Authors
Simon-Pierre Cadieux
Eric S. Raymond
Gilles Vollant

and with the following additions to the disclaimer:

There is no warranty against interference with your enjoyment of the library or against infringement. There is no warranty that our efforts or the library will fulfill any of your particular purposes or needs. This library is provided with all faults, and the entire risk of satisfactory quality, performance, accuracy, and effort is with the user.

libpng versions 0.97, January 1998, through 1.0.6, March 20, 2000, are Copyright © 1998, 1999 Glenn Randers-Pehrson, and are distributed according to the same disclaimer and license as libpng-0.96, with the following individuals added to the list of Contributing Authors:
Tom Lane
Glenn Randers-Pehrson
Willem van Schaik

libpng versions 0.89, June 1996, through 0.96, May 1997, are Copyright © 1996, 1997 Andreas Dilger Distributed according to the same disclaimer and license as libpng-0.88, with the following individuals added to the list of Contributing Authors:
John Bowler
Kevin Bracey
Sam Bushell
Magnus Holmgren
Greg Roelofs
Tom Tanner

libpng versions 0.5, May 1995, through 0.88, January 1996, are Copyright © 1995, 1996 Guy Eric Schalnat, Group 42, Inc.

For the purposes of this copyright and license, "Contributing Authors" is defined as the following set of individuals:

Andreas Dilger
Dave Martindale
Guy Eric Schalnat
Paul Schmidt

Tim Wegner

The PNG Reference Library is supplied "AS IS". The Contributing Authors and Group 42, Inc. disclaim all warranties, expressed or implied, including, without limitation, the warranties of merchantability and of fitness for any purpose. The Contributing Authors and Group 42, Inc. assume no liability for direct, indirect, incidental, special, exemplary, or consequential damages, which may result from the use of the PNG Reference Library, even if advised of the possibility of such damage.

Permission is hereby granted to use, copy, modify, and distribute this source code, or portions hereof, for any purpose, without fee, subject to the following restrictions:

1. The origin of this source code must not be misrepresented.
2. Altered versions must be plainly marked as such and must not be misrepresented as being the original source.
3. This Copyright notice may not be removed or altered from any source or altered source distribution.

The Contributing Authors and Group 42, Inc. specifically permit, without fee, and encourage the use of this source code as a component to supporting the PNG file format in commercial products. If you use this source code in a product, acknowledgment is not required but would be appreciated.

About zlib Library

Copyright notice:

©1995-2010 Jean-loup Gailly and Mark Adler

This software is provided "as-is", without any express or implied warranty. In no event will the authors be held liable for any damages arising from the use of this software.

Permission is granted to anyone to use this software for any purpose, including commercial applications, and to alter it and redistribute it freely, subject to the following restrictions:

1. The origin of this software must not be misrepresented; you must not claim that you wrote the original software. If you use this software in a product, an acknowledgment in the product documentation would be appreciated but is not required.
2. Altered source versions must be plainly marked as such, and must not be misrepresented as being the original software.
3. This notice may not be removed or altered from any source distribution.

About FLAC codec Library

Copyright ©2000,2001,2002,2003,2004,2005,2006,2007, 2008,2009 Josh Coalsoun
Redistribution and use in source and binary forms, with or without modification, are permitted provided that the following conditions are met:

- Redistributions of source code must retain the above copyright notice, this list of conditions and the following disclaimer.
- Redistributions in binary form must reproduce the above copyright notice, this list of conditions and the following disclaimer in the documentation and/or other materials provided with the distribution.
- Neither the name of the Xiph.org Foundation nor the names of its contributors may be used to endorse or promote products derived from this software without specific prior written permission.

THIS SOFTWARE IS PROVIDED BY THE COPYRIGHT HOLDERS AND CONTRIBUTORS "AS IS" AND ANY EXPRESS OR IMPLIED WARRANTIES, INCLUDING, BUT NOT LIMITED TO, THE IMPLIED WARRANTIES OF MERCHANTABILITY AND FITNESS FOR A PARTICULAR PURPOSE ARE DISCLAIMED. IN NO EVENT SHALL THE FOUNDATION OR CONTRIBUTORS BE LIABLE FOR ANY DIRECT, INDIRECT, INCIDENTAL, SPECIAL, EXEMPLARY, OR CONSEQUENTIAL DAMAGES (INCLUDING, BUT NOT LIMITED TO, PROCUREMENT OF SUBSTITUTE GOODS OR SERVICES; LOSS OF USE, DATA, OR PROFITS; OR BUSINESS INTERRUPTION) HOWEVER CAUSED AND ON ANY THEORY OF LIABILITY, WHETHER IN CONTRACT, STRICT LIABILITY, OR TORT (INCLUDING NEGLIGENCE OR OTHERWISE) ARISING IN ANY WAY OUT OF THE USE OF THIS SOFTWARE, EVEN IF ADVISED OF THE POSSIBILITY OF SUCH DAMAGE.

About lwIP Library

Copyright © 2001-2004 Swedish Institute of Computer Science.
All rights reserved.

Copyright © 2002-2003, Adam Dunkels.
All rights reserved.

Copyright © 2001-2004 Leon Woestenberg
<leon.woestenberg@gmx.net>
Copyright © 2001-2004 Axon Digital Design B.V., The Netherlands.
All rights reserved.

Copyright © 2007 Dominik Spies <kontakt@dspies.de>
All rights reserved.

Redistribution and use in source and binary forms, with or without modification, are permitted provided that the following conditions are met:

1. Redistributions of source code must retain the above copyright notice, this list of conditions and the following disclaimer.
2. Redistributions in binary form must reproduce the above copyright notice, this list of

conditions and the following disclaimer in the documentation and/or other materials provided with the distribution.

3. The name of the author may not be used to endorse or promote products derived from this software without specific prior written permission.

THIS SOFTWARE IS PROVIDED BY THE AUTHOR "AS IS" AND ANY EXPRESS OR IMPLIED WARRANTIES, INCLUDING, BUT NOT LIMITED TO, THE IMPLIED WARRANTIES OF MERCHANTABILITY AND FITNESS FOR A PARTICULAR PURPOSE ARE DISCLAIMED. IN NO EVENT SHALL THE AUTHOR BE LIABLE FOR ANY DIRECT, INDIRECT, INCIDENTAL, SPECIAL, EXEMPLARY, OR CONSEQUENTIAL DAMAGES (INCLUDING, BUT NOT LIMITED TO, PROCUREMENT OF SUBSTITUTE GOODS OR SERVICES; LOSS OF USE, DATA, OR PROFITS; OR BUSINESS INTERRUPTION) HOWEVER CAUSED AND ON ANY THEORY OF LIABILITY, WHETHER IN CONTRACT, STRICT LIABILITY, OR TORT (INCLUDING NEGLIGENCE OR OTHERWISE) ARISING IN ANY WAY OUT OF THE USE OF THIS SOFTWARE, EVEN IF ADVISED OF THE POSSIBILITY OF SUCH DAMAGE.

Copyright © 2002 CITEL Technologies Ltd.
All rights reserved.

Redistribution and use in source and binary forms, with or without modification, are permitted provided that the following conditions are met:

1. Redistributions of source code must retain the above copyright notice, this list of conditions and the following disclaimer.
2. Redistributions in binary form must reproduce the above copyright notice, this list of conditions and the following disclaimer in the documentation and/or other materials provided with the distribution.
3. Neither the name of CITEL Technologies Ltd nor the names of its contributors may be used to endorse or promote products derived from this software without specific prior written permission.

THIS SOFTWARE IS PROVIDED BY CITEL TECHNOLOGIES AND CONTRIBUTORS "AS IS" AND ANY EXPRESS OR IMPLIED WARRANTIES, INCLUDING, BUT NOT LIMITED TO, THE IMPLIED WARRANTIES OF MERCHANTABILITY AND FITNESS FOR A PARTICULAR PURPOSE ARE DISCLAIMED. IN NO EVENT SHALL CITEL TECHNOLOGIES OR CONTRIBUTORS BE LIABLE FOR ANY DIRECT, INDIRECT, INCIDENTAL, SPECIAL, EXEMPLARY, OR CONSEQUENTIAL DAMAGES (INCLUDING, BUT NOT LIMITED TO, PROCUREMENT OF SUBSTITUTE GOODS OR SERVICES; LOSS OF USE, DATA, OR PROFITS; OR BUSINESS INTERRUPTION) HOWEVER CAUSED AND ON ANY THEORY OF LIABILITY, WHETHER IN CONTRACT, STRICT LIABILITY, OR TORT (INCLUDING NEGLIGENCE OR OTHERWISE) ARISING IN ANY WAY OUT OF THE USE OF THIS SOFTWARE, EVEN IF ADVISED OF THE POSSIBILITY OF SUCH DAMAGE.

Notice for Windows Media DRM

Use or distribution of such technology outside of this product is prohibited without a license from Microsoft.

Content owners use Windows Media digital rights management technology (WMDRM) to protect their intellectual property, including copyrights. This device uses WMDRM software to access WMDRM protected content. If the WMDRM software fails to protect the content, content owners may ask Microsoft to revoke the software's ability to use WMDRM to play or copy protected content. Revocation does not affect unprotected content. When you download licenses for protected content, you agree that Microsoft may include a revocation list with the licenses. Content owners may require you to upgrade WMDRM to access their content. If you decline an upgrade, you will not be able to access content that requires the upgrade.

Do not disassemble, decompile, or reverse engineer the software included in Yamaha AV products.

About Apple Lossless Audio Codec

Copyright © 2011 Apple Inc. All rights reserved.

Licensed under the Apache License, Version 2.0 (the "License"); you may not use this file except in compliance with the License.
You may obtain a copy of the License at

<http://www.apache.org/licenses/LICENSE-2.0>

Unless required by applicable law or agreed to in writing, software distributed under the License is distributed on an "AS IS" BASIS, WITHOUT WARRANTIES OR CONDITIONS OF ANY KIND, either express or implied.
See the License for the specific language governing permissions and limitations under the License.

CAUTION

Use of controls or adjustments or performance of procedures other than those specified herein may result in hazardous radiation exposure.

LASER SAFETY

This unit employs a laser. Due to possible eye injury, only a qualified service person should remove the cover or attempt to service this device.

DANGER

This unit emits visible laser radiation when open. Avoid direct eye exposure to beam. When this unit is plugged into the wall outlet, do not place your eyes close to the opening of the disc tray and other openings to look into inside.

LASER

Type	Semiconductor laser GaAs/GaAlAs
Wave length	790 nm
Output Power	10 mW

The laser component in this product is capable of emitting radiation exceeding the limit for Class 1.

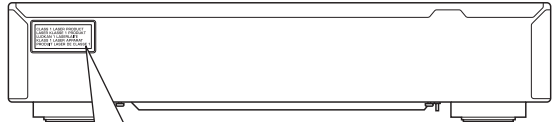

CLASS 1 LASER PRODUCT
LASER KLASSE 1 PRODUKT
LUOKAN 1 LASERLAITE
KLASS 1 LASER APPARAT
PRODUIT LASER DE CLASSE 1

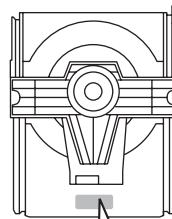

CAUTION: INVISIBLE LASER RADIATION WHEN OPEN.
DO NOT STARE INTO BEAM.
DANGER: INVISIBLE LASER RADIATION WHEN OPEN.
AVOID DIRECT EXPOSURE TO THE BEAM.

