

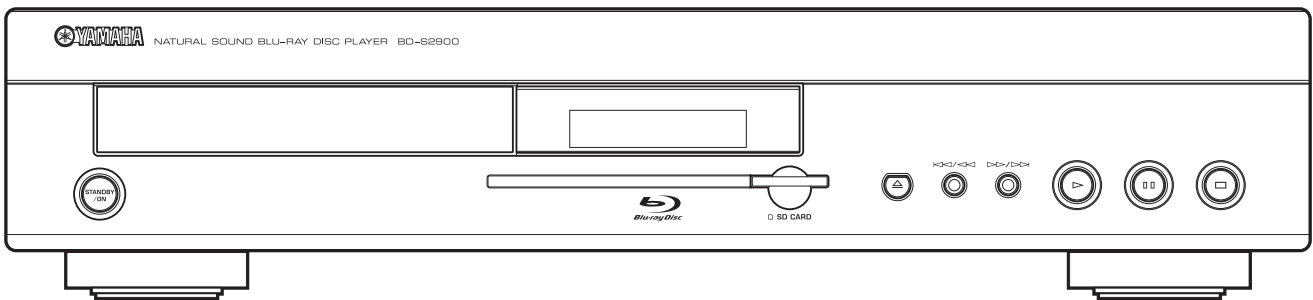

BLU-RAY DISC PLAYER

BD-S2900

OWNER'S MANUAL



BD-Video



BONUS VIEW™



CAUTION: READ THIS BEFORE OPERATING THIS UNIT.

- To assure the finest performance, please read this manual carefully. Keep it in a safe place for future reference.
- Install this unit in a well ventilated, cool, dry, clean place — away from direct sunlight, heat sources, vibration, dust, moisture, or cold. In a cabinet, allow about 2.5 cm (1 inch) of free space all around this unit for adequate ventilation.
- Locate this unit away from other electrical appliances, motors, or transformers to avoid humming sounds.
- Do not expose this unit to sudden temperature changes from cold to hot, nor locate this unit in an environment with high humidity (i.e., a room with a humidifier) to prevent condensation inside this unit, which may cause an electrical shock, fire, damage to this unit, and/or personal injury.
- Avoid installing this unit in a location where foreign objects may fall onto this unit or where this unit may be exposed to liquid dripping or splashing. On the top of this unit, do not place:
 - Other components, as they may cause damage and/or discoloration on the surface of this unit.
 - Burning objects (i.e., candles), as they may cause fire, damage to this unit, and/or personal injury.
 - Containers with liquid in them, as they may fall, spilling the liquid and causing an electrical shock to the user and/or damage to this unit.
- Do not cover this unit with a newspaper, tablecloth, curtain, etc. in order not to obstruct heat radiation. If the temperature inside this unit rises, it may cause fire, damage to this unit, and/or personal injury.
- Do not plug in this unit to a wall outlet until all connections are complete.
- Do not operate this unit upside-down. It may overheat, possibly causing damage.
- Do not use excessive force on switches, knobs and/or cords.
- When disconnecting the power cord from the wall outlet, grasp the plug; do not pull the cord.
- Do not clean this unit with chemical solvents; this might damage the finish. Use a clean, dry cloth.
- Use only the voltage specified on this unit. Using this unit with a higher voltage than specified is dangerous and may cause fire, damage to this unit, and/or personal injury. Yamaha will not be held responsible for any damage resulting from use of this unit with a voltage other than as specified.
- Do not attempt to modify or fix this unit. Contact qualified Yamaha service personnel when any service is needed. The cabinet should never be opened for any reason.
- When not planning to use this unit for long periods of time (i.e., vacation), disconnect the AC power plug from the wall outlet.
- Be sure to read the “TROUBLESHOOTING GUIDE” section on common operating errors before concluding that this unit is faulty.
- Before moving this unit, press STANDBY/ON to set the unit in standby mode, then disconnect the AC power plug from the wall outlet.
- Install this unit near the AC outlet and where the AC power plug can be reached easily.

- The batteries shall not be exposed to excessive heat such as sunshine, fire or the like.

The unit is not disconnected from the AC power source as long as it is connected to the wall outlet, even if this unit itself is turned off by STANDBY/ON. This state is called the standby mode. In this state, this unit is designed to consume a very small quantity of power.

WARNING

TO REDUCE THE RISK OF FIRE OR ELECTRIC SHOCK, DO NOT EXPOSE THIS UNIT TO RAIN OR MOISTURE.

CAUTION

Use of controls or adjustments or performance of procedures other than those specified herein may result in hazardous radiation exposure.

LASER Specification:

Class I LASER Product

- Wave length: 782 nm (CDs)/662 nm (DVDs)/405 nm (BDs)
- Laser power: No hazardous radiation is emitted with the safety protection

LASER SAFETY

This unit employs a laser. Due to possible eye injury, only a qualified service person should remove the cover or attempt to service this device.

DANGER

This unit emits visible laser radiation when open. Avoid direct eye exposure to beam.

When this unit is plugged into a wall outlet, do not place your eyes close to the opening of the disc tray and other openings or look inside.

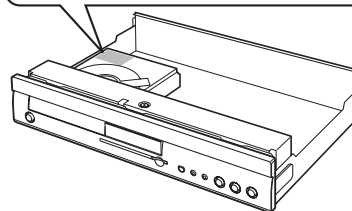
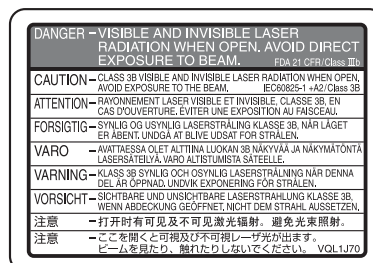

Region management information

BD-Video

This unit plays BD-Video marked with labels containing the region code B.

Example:



DVD-Video

This unit plays DVD-Video marked with labels containing the region number “4” or “ALL”.

Example:



TABLE OF CONTENTS

GETTING STARTED

| | |
|---------------------------------|---|
| ACCESSORY INFORMATION | 1 |
| DISC AND CARD INFORMATION | 2 |
| USING REMOTE CONTROL..... | 3 |
| CONNECTION | 4 |
| CONTROL REFERENCE GUIDE..... | 7 |
| EASY SETTING..... | 8 |

PLAYBACK

| | |
|--|----|
| BASIC PLAY (PLAYING VIDEO CONTENTS)..... | 9 |
| DIFFERENT KINDS OF PLAYBACK FOR BD-VIDEO.. | 11 |
| CHAPTER PLAYBACK..... | 12 |
| PLAYING STILL PICTURES | 12 |
| PLAYING MUSIC..... | 14 |
| SHOWING FUNCTIONS MENU | 14 |
| ABOUT MP3/JPEG FILES | 15 |
| LINKED OPERATIONS WITH THE TV | 16 |

SETTINGS

| | |
|---|----|
| CHANGING SETTINGS WITH THE ON-SCREEN MENU | 17 |
| CHANGING THE UNIT'S SETTINGS | 19 |

REFERENCE

| | |
|---------------------------------|------------|
| FREQUENTLY ASKED QUESTIONS..... | 23 |
| TROUBLESHOOTING GUIDE..... | 24 |
| MESSAGES | 27 |
| DISC AND CARD HANDLING | 27 |
| MAINTENANCE | 27 |
| SPECIFICATIONS..... | 28 |
| GLOSSARY..... | 29 |
| INDEX..... | BACK COVER |

GETTING STARTED

ACCESSORY INFORMATION

Please check and identify the supplied accessories.



Remote control



Audio/Video cable



Batteries (AA, R6, UM-3) (x 2)
for remote control

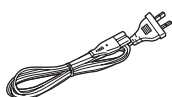

Power cable



- For use with this unit only. Do not use it with other equipment.
Also, do not use power cables for other equipment with this unit.

DISC AND CARD INFORMATION

Packaged discs

This chart shows the different type of retail/commercial discs you can use, and also includes the industry-standard logos that should appear on the discs and/or packaging.





| Type of media/Logo | Features | Indicated as |
|---|--|--------------|
| BD-Video  BD-Video | High Definition (HD) movie and music discs | BD-V |

| Type of media/Logo | Features | Indicated as |
|---|---|--------------|
| DVD-Video  | High quality movie and music discs | DVD-V |
| CD  | Compact Discs (CD's) that contain audio and music <ul style="list-style-type: none"> Operation and sound quality of CDs that do not conform to CD-DA specifications (copy control CDs, etc.) cannot be guaranteed. | CD |

Recorded discs

This chart shows the different type of discs recorded with DVD recorders, DVD video cameras, personal computers, etc. that you can use.

Finalized This mark means you must finalize the disc with the DVD recorder, etc. before playback. For details about finalizing, refer to the operating instructions for your equipment.

| Type of media/Logo | Formats | Indicated as |
|---|---|---|
| BD-RE  | <ul style="list-style-type: none"> Version 3 of the BD-RE Recording Format JPEG format | BD-V JPEG |
| BD-R  | <ul style="list-style-type: none"> Version 2 of the BD-R Recording Format | BD-V |
| DVD-RAM  | <ul style="list-style-type: none"> Version 1.1 of the DVD Video Recording Format JPEG format AVCHD format | DVD-VR JPEG AVCHD |
| DVD-R/RW Finalized   | <ul style="list-style-type: none"> DVD-Video Format Version 1.1 of the DVD Video Recording Format AVCHD format | DVD-V DVD-VR AVCHD |

| Type of media/Logo | Formats | Indicated as |
|--|---|---|
| DVD-R DL Finalized  | <ul style="list-style-type: none"> DVD-Video Format Version 1.2 of the DVD Video Recording Format AVCHD format | DVD-V DVD-VR AVCHD |
| DVD+R/+RW/+R DL Finalized | <ul style="list-style-type: none"> DVD+VR (DVD+R/+RW Video Recording) Format AVCHD format | DVD-V AVCHD |
| CD-R/RW Finalized | <ul style="list-style-type: none"> CD-DA format MP3 format JPEG format | CD MP3 JPEG |

- It may not be possible to play the above discs in some cases due to the type of discs, the condition of the recording, the recording method and how the files were created.
- When a disc recorded in the AVCHD format is being played, the video may be paused for a few seconds at portions spliced, due to deletion or editing.

SD cards

This chart shows the different type of cards recorded with High Definition Camcorder or personal computers, etc. that you can use.

| Type of media | Formats | Indicated as |
|--|---|---|
| SD Memory Card* (from 8 MB to 2 GB) SDHC Memory Card (from 4 GB to 16 GB) | <ul style="list-style-type: none"> JPEG format AVCHD format |  |

- * Including miniSD Card and microSD Card
- When using from 4 GB to 16 GB SD cards, only SD cards that display the SDHC logo can be used.
- This unit is compatible with SD Memory Cards that meet SD Card Specifications FAT 12 and FAT 16 formats, as well as SDHC Memory Cards in FAT 32 format.

- In this owner's manual, the cards shown in the table (⇒ left) are comprehensively called SD cards.
- A miniSD Card and a microSD Card must be used with the attached adaptor that comes with the card.
- Usable memory is slightly less than the card capacity.
- If the SD card is formatted on a PC, you may not be able to use it on this unit.
- Keep the Memory Card out of reach of children to prevent swallowing.
- When a card recorded in the AVCHD format is being played, the video may be paused for a few seconds at portions spliced, due to deletion or edition.
- Switch the write-protect switch to the "LOCK" position to protect the content from accidental erasure.



Regarding BD-Video

- Enjoy *Final Standard Profile* functions (⇒ 11), such as picture-in-picture. The various functions differ depending on the disc.
- When playing a set of two or more BD-Video discs, the menu screen of the previous disc may continue to display even if the disc has been ejected.
- **Regarding high specification audio (7.1ch) of BD-Video such as Dolby Digital Plus, Dolby TrueHD, DTS-HD High Resolution Audio and DTS-HD Master Audio (⇒ 20)**
 - they can be reproduced in the original format only when connected to a compatible amplifier/receiver with a HDMI AV OUT terminal (⇒ 5) and when "BD-Video Secondary Audio" is set to "Off" and "Bitstream" is selected in each format.
 - they are output only as Dolby Digital bitstream when "BD-Video Secondary Audio" is set to "On" even when the unit is connected using the HDMI AV OUT terminal.
 - they are output only as Dolby Digital or DTS bitstream (depending to the original format) when the unit is connected using the DIGITAL AUDIO OUT terminal.

Discs that cannot be played

- BD-RE with the cartridge
- 2.6 GB and 5.2 GB DVD-RAM
- 3.95 GB and 4.7 GB DVD-R for Authoring
- DVD-RAM that cannot be removed from their cartridges
- Version 1.0 of DVD-RW
- DVD+R 8 cm (3"), DVD-ROM, CD-ROM, CDV, Photo CD, MV-Disc and PD
- SACD (except for CD layer)
- DVD-Audio (except for DVD-Video part)
- Video CD and SVCD
- WMA discs
- DivX discs
- HD DVD
- Other discs that are not specifically supported

USING REMOTE CONTROL

Batteries

Insert so the poles (+ and -) match those in the remote control.

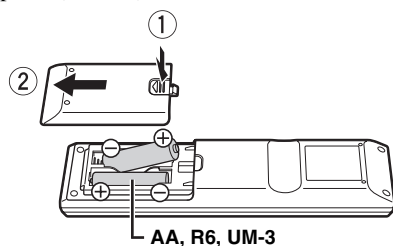

- Do not use rechargeable type batteries.
- Do not mix old and new batteries.
- Do not use different types at the same time.
- Do not heat or expose to flame.
- Do not leave the battery(ies) in an automobile exposed to direct sunlight for a long period of time with doors and windows closed.
- Do not take apart or short circuit.
- Do not attempt to recharge alkaline or manganese batteries.
- Do not use batteries if the covering has been peeled off.

Mishandling of batteries can cause electrolyte leakage which can damage items the fluid contacts and may cause a fire.

Remove batteries if the remote control is not going to be used for a long period of time. Store in a cool, dark place.

Use

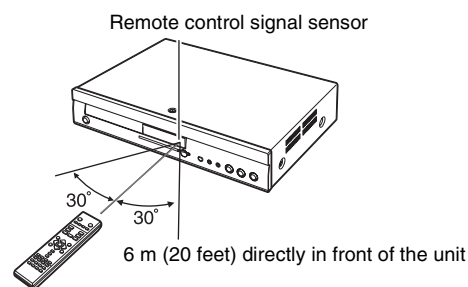

CONNECTION

From the list below, please choose the connection method that fits your TV viewing environment best.

- If you connect to a television using an included Audio/Video cable ⇒ **A**
- If you connect to an HDMI (⇒ 29) compatible television ⇒ **B**
- If you connect to an HDMI compatible television and an HDMI compatible amplifier/receiver to enjoy surround sound ⇒ **C** (⇒ 5)
- For other connection methods, please see pages 5 and 6.

- **Do not connect through the video cassette recorder.** Due to copy guard protection, the picture may not display properly.
- Turn off all equipment before connection and read the appropriate operating instructions.

Conserving power

This unit consumes a small amount of power even when it is turned off (less than 1 W). To save power when the unit is not to be used for a long time, unplug it from the household AC mains socket.

- **Non-HDMI-compliant cables cannot be utilized.**
- **Please use HIGH SPEED HDMI cables that have the HDMI logo (as shown on the cover).**

Basic connections

A Connecting to a television with an Audio/Video cable

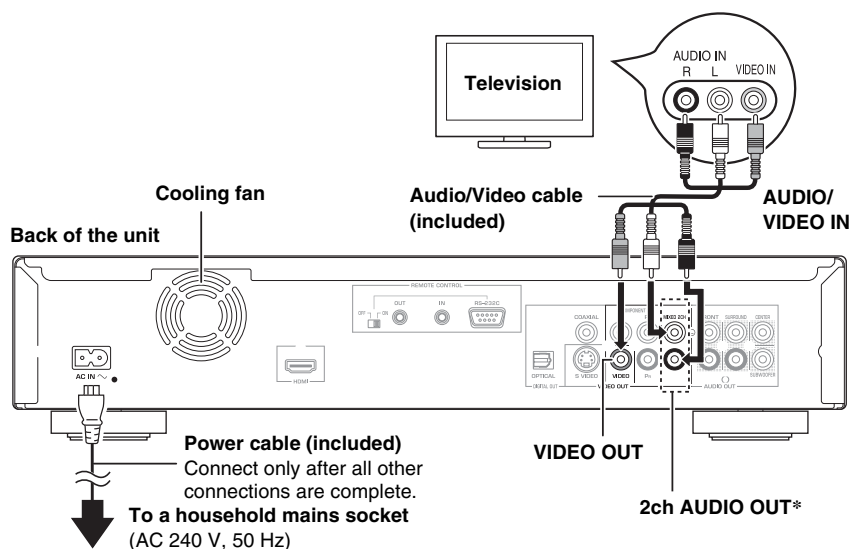

Notes

- Connect terminals of the same colour.
- High definition video cannot be output with this connection. Use connection **B**, **C** or **E** (⇒ 5) for high definition video.

Tips

- * With audio cables, connect the AUDIO OUT terminals to the two-channel audio input terminals of an analog amplifier/receiver or system component in place of a television to enjoy stereo sound.

To improve picture quality

- Use connections **D** or **E** (⇒ 5).

To enjoy a richer sound

- Use connections **F** or **G** (⇒ 6). (Unplug the red and white plugs.)

B Connecting to an HDMI compatible television

You can enjoy high quality, digital video and audio.

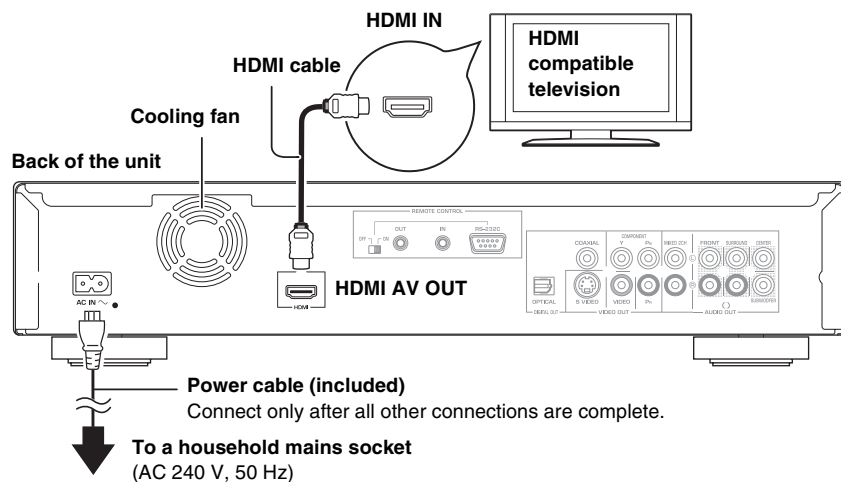

Note

NECESSARY SETTINGS

- “HDMI Video Mode” and “HDMI Audio Output” : “On” (⇒ 21)

Tips

To enjoy a richer sound

- Use connections **F** or **G** (⇒ 6) additionally. In this case, set “HDMI Video Mode” to “On” and “HDMI Audio Output” to “Off” (⇒ 21).

With this connection, you can use linked operations with the TV (⇒ 16).

C Connecting to an HDMI compatible television and HDMI compatible amplifier/receiver

When connected to a compatible amplifier/receiver, you can enjoy surround sound recorded with Dolby Digital Plus, Dolby TrueHD or DTS-HD.

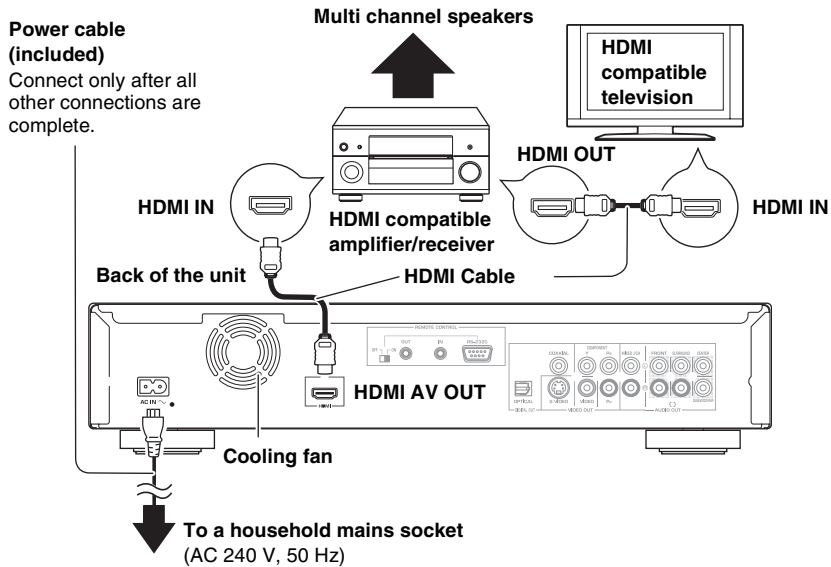

Notes

NECESSARY SETTINGS

- “HDMI Video Mode” and “HDMI Audio Output” : “On” (⇒ 21)
- “Speaker” : “Multi Channel” (⇒ 21)
- “Digital Audio Output” : Depending on the connected amplifier/receiver (⇒ 20)

Tip

With this connection, you can use linked operations with the TV (⇒ 16).

Connection methods for using other video terminals

D With S VIDEO OUT

The S VIDEO OUT terminal provides a more vivid picture than the VIDEO OUT terminal.

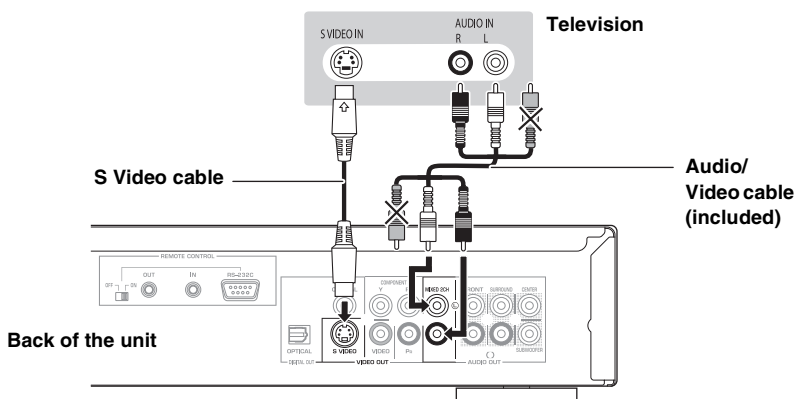

Notes

- High definition video cannot be output with this connection.
Use connection B (⇒ 4), C or E for high definition video.
- Unplug the yellow plug of Audio/Video cable.
- Actual video quality depends on the television.

E With COMPONENT VIDEO OUT

You can enjoy high definition images by connecting to a component video terminals that supports 720p (750p) and 1080i (1125i) signals.

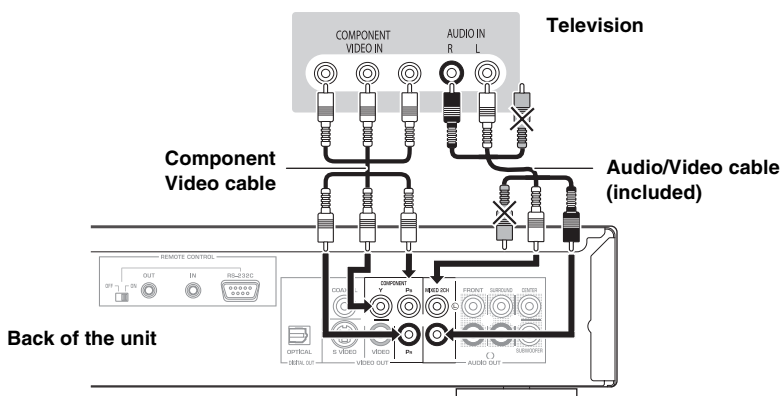

Notes

- Connect terminals of the same colour.
- Unplug the yellow plug of Audio/Video cable.
- The video output resolution is restricted to “576p/480p” when DVD-Video and BD-Video discs recorded at a rate of 50 frames per second is output from the COMPONENT VIDEO OUT terminals.

Tips

If you have a regular television (CRT: cathode ray tube)

- Progressive output may cause some flickering, even if it is progressive compatible. Turn off “Progressive” if you are concerned about it. This is the same for multi system televisions using PAL mode. (⇒ 18, “Progressive”)

To enjoy high definition/progressive video

- Connect to a television that supports 576p/480p or higher.
- Set “Component Resolution” to “576p/480p”, “720p” or “1080i”. (⇒ 21)
- Set “HDMI Video Mode” to “Off”. (⇒ 21)
Otherwise, the video is output as 576i/480i.

Connecting an amplifier/receiver (excluding HDMI connection)

F With 5.1ch AUDIO OUT

When connected to a compatible amplifier/receiver using the 5.1ch AUDIO OUT terminals, you can enjoy surround sound.

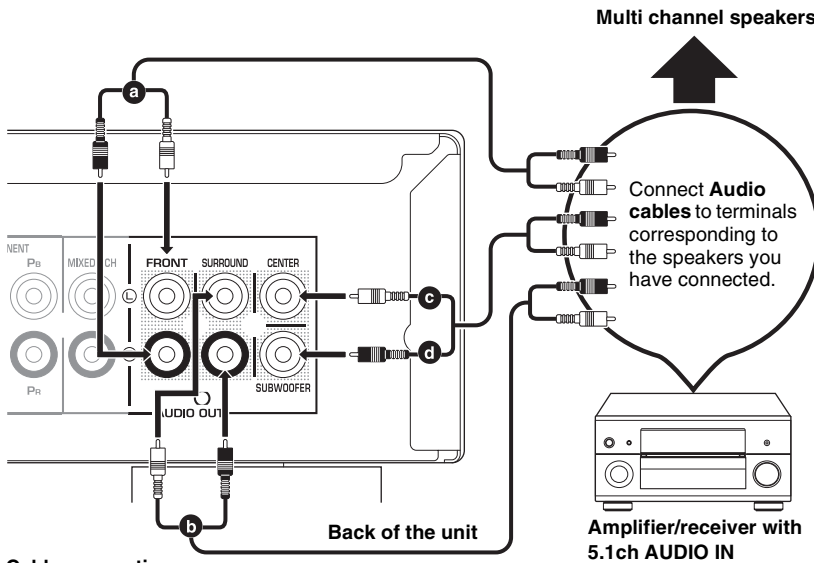

Cable connections

- a** Front speaker (L/R)
- b** Surround speaker (L/R)
- c** Centre speaker
- d** Subwoofer

Notes

NECESSARY SETTINGS

- “Speaker” : “Multi-Channel” (⇒ 21)
- 7.1 channel disc is mixed down to 5.1 channel audio.

When connected to an HDMI compatible television (⇒ 4, B)

- “HDMI Audio Output” : “Off” (⇒ 21)
(Otherwise, the sound is output from the television.)
- Depending on how the disc was recorded, the audio may not be output properly on the number of channels desired.

G With DIGITAL AUDIO OUT

You can enjoy surround sound, when connected to an amplifier/receiver using the COAXIAL or OPTICAL terminal.

With COAXIAL

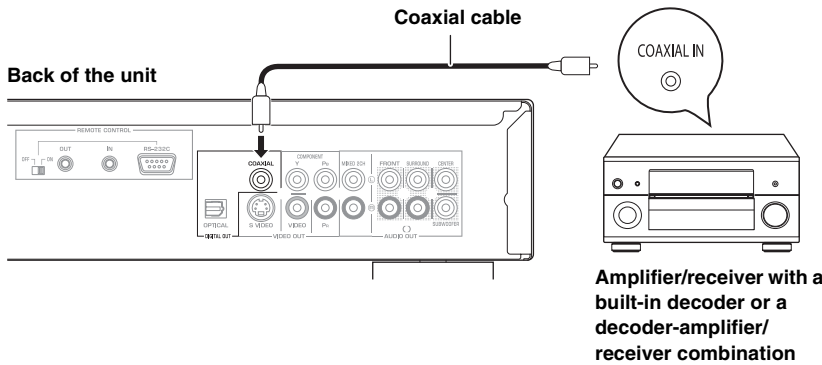

Notes

NECESSARY SETTINGS

- “Digital Audio Output” : Depending on the connected amplifier/receiver (⇒ 20)

When connected to an HDMI compatible television (⇒ 4, B)

- “HDMI Audio Output” : “Off” (⇒ 21)
(Otherwise, the sound may not be output with the desired settings.)

With OPTICAL

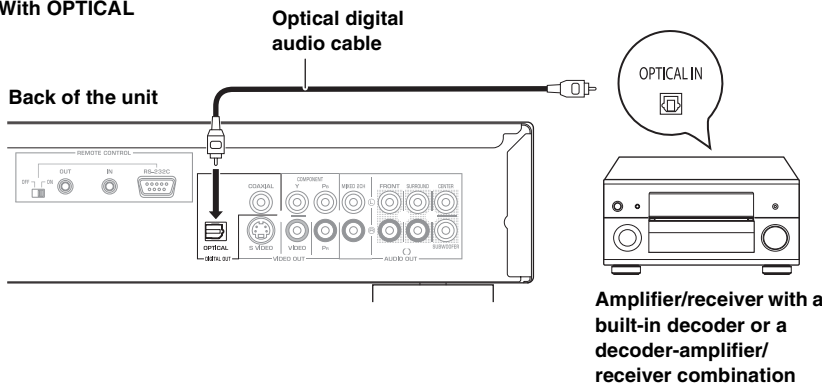

Using remote control functions

Back of the unit

Monaural 3.5 mm mini plug cable

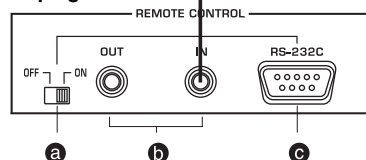

Amplifier/receiver
with REMOTE OUT
jack

a REMOTE CONTROL (ON, OFF) switch

Switches the remote control (RS-232C) on or off. When using REMOTE CONTROL (RS-232C) terminal, set this switch to ON.

b REMOTE CONTROL (IN/OUT) jacks

Connect to the remote control output/input jack of your audio/video component. If your AV amplifier/receiver is a Yamaha product and has the capability to transmit of SCENE control signals, you can use the SCENE function by connecting REMOTE CONTROL IN jack of this unit to the REMOTE OUT jack of the amplifier/receiver.

c REMOTE CONTROL (RS-232C) terminal

Use as an expansion terminal for commercial use. Consult your dealer for details.

Tips

- For details about the SCENE function, refer to the owner's manual supplied with your Yamaha AV amplifier/receiver.
- The REMOTE CONTROL (IN, OUT) jacks are also used in custom installation.
- You can connect a Yamaha component (such as DVD player and CD player) corresponds with the SCENE function to the REMOTE CONTROL (OUT) jack of this unit.

Note

When using the SCENE function, do not connect a power cable of this unit to AC outlet on the rear panel of AV amplifier/receiver.

CONTROL REFERENCE GUIDE

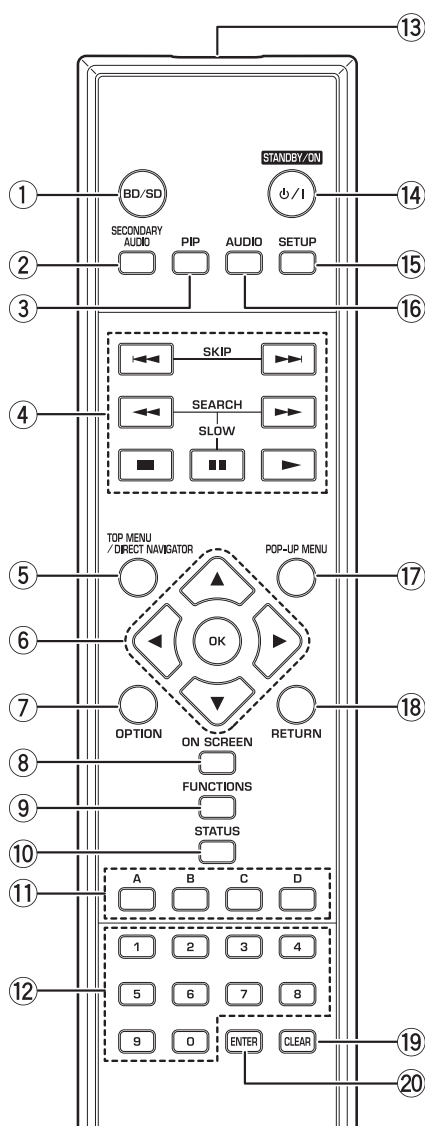

- ① Select disc drive or SD card drive (⇒ 9)
- ② Switch on/off Secondary Audio (⇒ 11)
- ③ Switch on/off Secondary Video (Picture-in-picture) (⇒ 11)
- ④ Basic playback control buttons (⇒ 9, 11)
- ⑤ Show TOP MENU/DIRECT NAVIGATOR (⇒ 9)
- ⑥ Selection/OK, Frame-by-frame (⇒ 10)
- ⑦ Show OPTION menu (⇒ 12)
- ⑧ Show on-screen menu (⇒ 17)
- ⑨ Show FUNCTIONS menu (⇒ 14)
- ⑩ Show status messages (⇒ 10)
- ⑪ These buttons are used when operating a BD-Video disc that includes Java™ applications (BD-J). For more information about operating this kind of disc, please read the instructions that came with the disc.
The [A] and [B] buttons are also used with the “Title View”, “Picture View” and “Album View” screens (⇒ 12).
- ⑫ Numbered buttons
Select title numbers, etc./Enter numbers (⇒ 10)
- ⑬ Transmit the remote control signal
- ⑭ Turn the unit on and off (⇒ 8)
- ⑮ Show Setup menu (⇒ 19)
- ⑯ Select audio (⇒ 10)
- ⑰ Show Pop-up menu (⇒ 11)
- ⑱ Return to previous screen
- ⑲ Clear
- ⑳ Provides the same function as OK button
This button is used to fix the setting immediately after pressing the numbered buttons.

CAUTION

Do not place objects in front of the unit. The disc tray may collide with objects when it is opened, and this may cause injury.

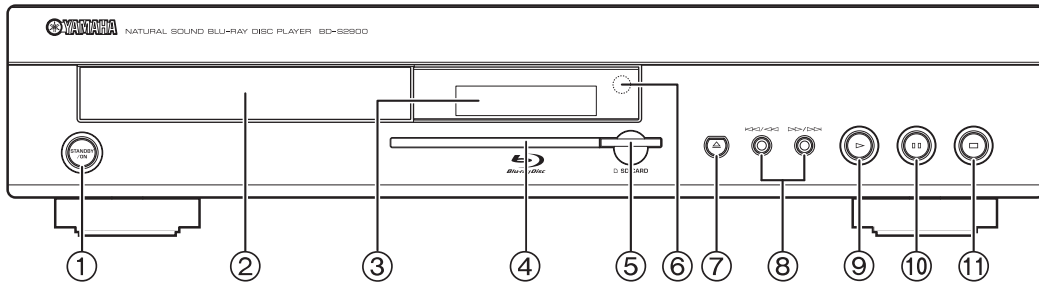

① **STANDBY/ON** button (⇒ 8)

Press to switch the unit from on to standby mode or vice versa. In standby mode, the unit is still consuming a small amount of power.

② Disc tray (⇒ 9)

③ Display



Disc indicator



SD SD card indicator

The indicator blinks when reading data from a disc or card.

④ SD Card LED

- It is possible to set the LED to turn on/off. (⇒ 21, SD Card LED Control)

⑤ SD card slot (⇒ 12)

⑥ Remote control signal sensor (⇒ 3)

⑦ Open or close the disc tray (⇒ 9)

⑧ Search/Slow-motion/Skip (⇒ 10)

Search: Press and hold (During play)

Slow-motion: Press and hold (During pause)

Skip: Press

⑨ Start play (⇒ 9)

⑩ Pause (⇒ 10)

⑪ Stop (⇒ 10)

Rear panel terminals (⇒ 4-7)

EASY SETTING

After connecting your new player and pressing the standby/on button, a screen for the basic settings will appear.

Preparation

Turn on the television and select the appropriate video input on the television.

1 Press [/ I **STANDBY/ON**].

→ Setup screen appears.

2 Follow the on-screen instructions and make the settings with [,] and [**OK**].

→ “TV Aspect” (⇒ 19) is set.

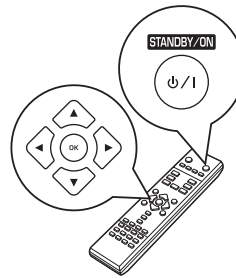

Tips

- You can perform this setup anytime by selecting “Easy Setting” in the Setup menu. (⇒ 19)
- You can also change these settings individually. (⇒ 19)
- If this unit is connected to a Panasonic TV (VIERA) supporting HDAVI Control 2 or HDAVI Control 3 via an HDMI cable, then the “TV Aspect” setting information on the TV is captured from the TV.

PLAYBACK

BASIC PLAY (PLAYING VIDEO CONTENTS)

Instructions for operations are generally described using the remote control in this owner's manual.

Preparation

Turn on the television and select the appropriate video input on the television.

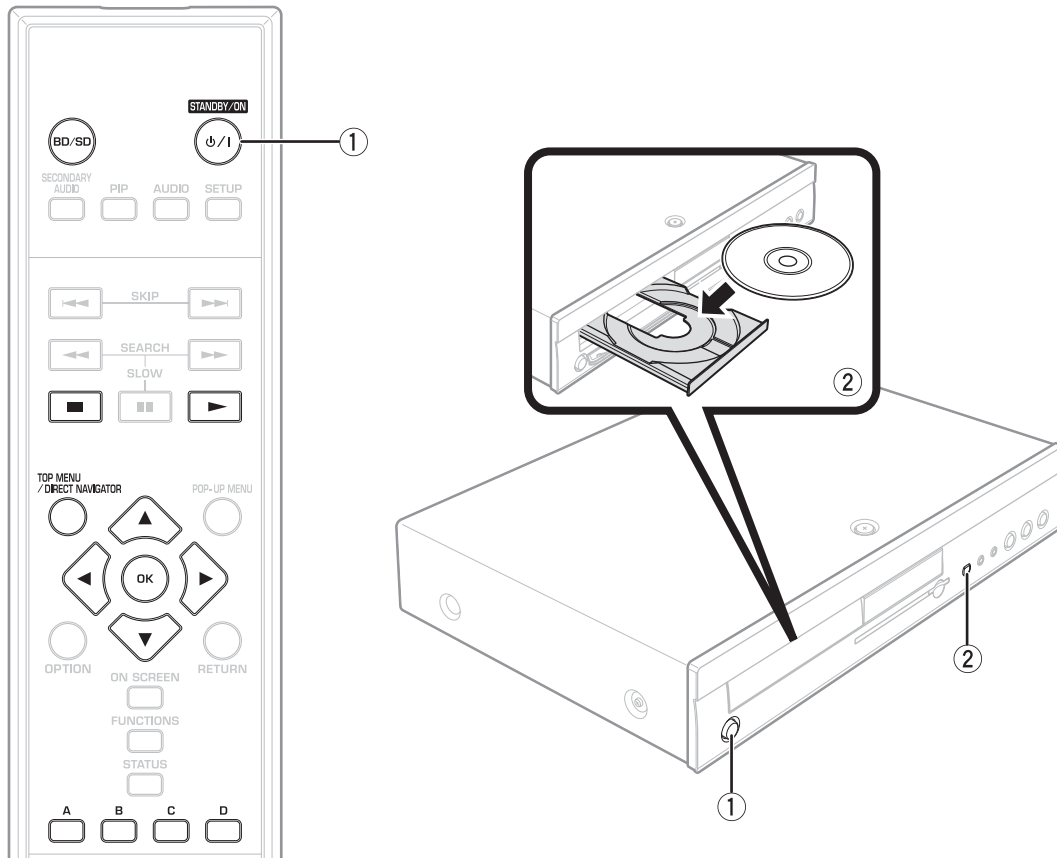
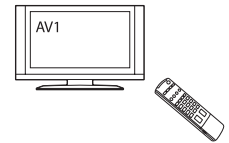

1 Press [**⏻/|** **STANDBY/ON**] to turn on the unit.

2 Press [**⏻** **OPEN/CLOSE**] to open the disc tray and load the disc.

- Press the button again to close the tray.
- Load double-sided discs so the label for the side you want to play is facing up.
- DVD-RAM: Remove discs from their cartridges before use.

Play starts.

- If a disc with data in different file formats is inserted, the file selection menu is displayed. Press [**▲**, **▼**] to select the desired file format and press [**OK**].
- If play does not start, press [**▶**] (PLAY).

e.g., **BD-V**



e.g., **DVD-VR**

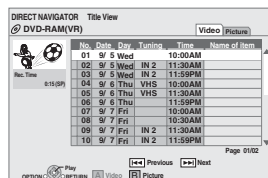

- If the menu is displayed, press [**▲**, **▼**, **◀**, **▶**] to select the item and press [**OK**].
- If the screen prompting you to use the colour buttons appears, continue to operate with the colour buttons on the remote control.

e.g.,



Notes

- Signal from PAL discs is output as PAL. Signal from NTSC discs is output as "NTSC" or "PAL60". You can select "NTSC" or "PAL60" in "NTSC Contents Output" for NTSC discs. (⇒ 19)
- DISCS CONTINUE TO ROTATE WHILE MENUS ARE DISPLAYED. Press [**■**] when you have finished playback to protect the unit's motor, your television screen and so on.

🌟 Tips

To switch drives

Press [**BD/SD**] to select "BD" to play a disc.

- If a disc or an SD card is inserted while the unit is stopped, the drive switches automatically depending on the inserted media.

To display menus

[**BD-V**] [**AVCHD**] [**DVD-VR**] [**DVD-V**]

Press [**TOP MENU/DIRECT NAVIGATOR**].

- The producers of the disc can control how discs are played. So you may not always be able to control play as described in this owner's manual. Read the disc's instructions carefully.

🌟 Tip

You can play data in AVCHD format recorded on an SD card.

Other operations during play

These functions may not work depending on the disc.

Stop

The stopped position is memorized.

Resume play function

Press [▶] (PLAY) to restart from this position.

- The position is cleared if the tray is opened or you press [■] several times to display "STOP" on unit's display.
- CD MP3**: The position is cleared if the unit is turned off.

Pause

- Press [■] again or [▶] (PLAY) to restart play.

Search/Slow-motion

The speed increases up to 5 steps.

- Press [▶] (PLAY) to revert to normal playback speed.
- For some discs, the speed may not change.

Search

While playing, press [◀◀] or [▶▶].

- Press and hold [◀◀] or [▶▶] on the main unit.
- BD-V AVCHD DVD-VR DVD-V**: Audio is heard during first level of forward search.
- CD MP3**: The speed is fixed to a single step.

Slow-motion

While paused, press [◀◀] or [▶▶].

- Press and hold [◀◀] or [▶▶] on the main unit.
- BD-V AVCHD**: Forward direction [▶▶] only.
- DVD-VR**: If continued for approx. 5 minutes, slow-motion play pauses automatically.

Skip

Skip to the title, chapter or track you want to play.

- Each press increases the number of skips.

Starting from a selected item





Play starts from the selected title or chapter.

BD-V AVCHD

e.g., 5: [0] ⇒ [0] ⇒ [5]
15: [0] ⇒ [1] ⇒ [5]

DVD-V

e.g., 5: [0] ⇒ [5]
15: [1] ⇒ [5]

- While stopped (the image on the right is displayed on the screen), the title is designated.
- While playing, the chapter is designated.



Frame-by-frame

While paused, press [◀] or [▶].

Each press shows the next frame.

- Press and hold to change in succession forward or backward.
- Press [▶] (PLAY) to revert to normal playback speed.
- BD-V AVCHD**: Forward direction [▶] only.

Screen Aspect

When black bars are shown at the top, bottom, left, and right sides of the screen, you can enlarge the image to fill the screen.

- Press [OPTION].
- Press [▲, ▼] to select "Screen Aspect" and press [OK].
- Press [◀, ▶] to select "Side cut" or "Zoom".

Normal: Normal output

Side cut: The black bars on the right and left sides of the 16:9 image disappear and the image is enlarged. Please note that the right and left sides of the image are cut off when the black bar is not displayed.

Zoom: The black bars on the top and bottom sides of the 4:3 image disappear and the image is enlarged. Please note that the top and bottom sides of the image are cut off when the black bar is not displayed.

- When "TV Aspect" (⇒ 21) is set to "4:3 Pan & Scan" or "4:3 Letterbox", the "Zoom" effect is disabled.

Status messages

The status messages give you information about what is currently being played. Each time you press [STATUS], the information displayed will change.

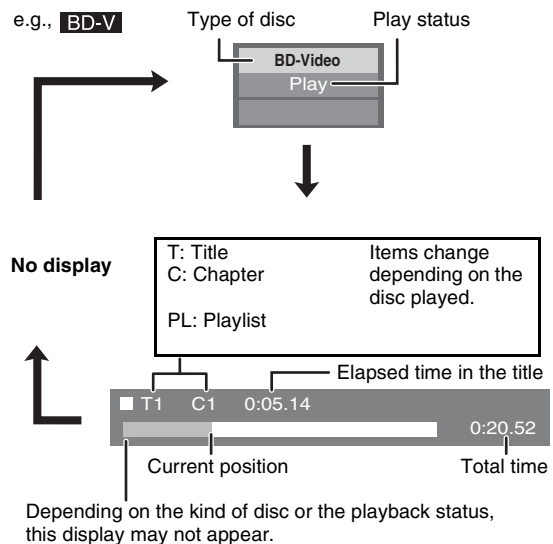

Changing audio during play

BD-V AVCHD DVD-V

e.g., **DVD-V**



English is selected.

You can change the audio channel number each time you press the button. This allows you to change the soundtrack language (⇒ 17, Soundtrack), etc.

DVD-VR

AudioLR → AudioL → AudioR

↑

"AudioLR" is selected



DIFFERENT KINDS OF PLAYBACK FOR BD-VIDEO

BD-V

Some discs permit a variety of interactive functions in addition to the ordinary playback operation.

Showing Pop-up menu

The Pop-up menu is a special feature available with some BD-Video discs. This menu may vary with discs. For the operating method, refer to the instructions for the disc.

- 1 Press [**POP-UP MENU**].
- 2 Press [**▲**, **▼**, **◀**, **▶**] to select the item and press [**OK**].

e.g.,

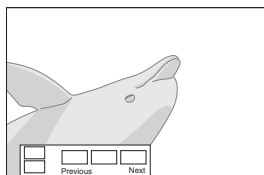
**Tip**

Pop-up menu also appears by pressing [**OPTION**] and selecting "Pop-up Menu".

To exit the screen

- Press [**POP-UP MENU**].

- The *Final Standard Profile* ["Picture-in-picture", "Virtual Package" (⇒ below), etc.] is a new playback function of BD-Video. Contents of playback and the operating method may vary with the disc. For details, refer to the instructions for the disc.

Playing secondary video (picture-in-picture) and secondary audio

Secondary video can be played from a disc compatible with the picture-in-picture function. For the playback method, refer to the instructions for the disc.

To turn on/off secondary video**Press [PIP].**

→ Secondary video is played.

- "PiP ON" is displayed.
- Press the button to turn it ON and OFF.

To turn on/off audio with the secondary video**Press [SECONDARY AUDIO].**

→ The secondary audio is played.

- "Secondary Audio ON" is displayed.
- Press the button to turn it ON and OFF.

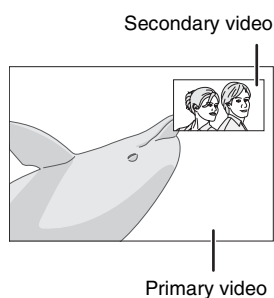
**Notes**

- Only the primary video is played during search/ slow-motion or frame-by-frame.
- When "BD-Video Secondary Audio" in "Digital Audio Output" is set to "Off", secondary audio will not be played even if [**SECONDARY AUDIO**] is pressed. Please check that "BD-Video Secondary Audio" is set to "On" (⇒ 20).

Virtual package

For a disc compatible with the virtual package (⇒ 29), data is copied to other media (⇒ 29, Local storage) from the disc to use the different functions while playing the data. For this unit, data is copied to an SD card.

The methods for copy and playback and the required available capacity on the card may vary with the disc. For details, refer to the instructions for the disc.

To use the above functions, it is recommended that you format the card on this unit.

Format the card using the following procedures. BD-Video data, such as secondary video recorded on the card, can also be erased with the following procedures.

■ Formatting SD cards/Deleting data

- 1 Insert an SD card (⇒ 12).
- 2 Press [**FUNCTIONS**].
- 3 Press [**▲**, **▼**] to select "To Others" and press [**OK**].
- 4 Press [**▲**, **▼**] to select "Card Management" and press [**OK**].
- 5 Press [**▲**, **▼**] to select "BD-Video Data Erase" or "Format SD Card" and press [**OK**].
- 6 Press [**◀**, **▶**] to select "Yes" and press [**OK**].
- 7 Press [**◀**, **▶**] to select "Start" and press [**OK**].

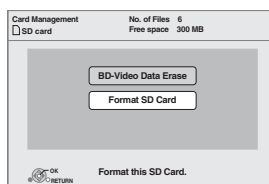
**Notes**

- If the SD card is removed from this unit when using data that was copied with the virtual package function, disc playback stops.
- Images and audio may freeze momentarily during playback.
- Data cannot be copied in the following cases.
 - The card is protected.
 - Available capacity on the card is too small. Delete unnecessary data or use a new card.
- When the function fails to work properly, even if the data is copied, format the card again with this unit. (In this case, all data will be erased.)

Tip

If an SD card with files in different formats is used, images and audio may not play back properly. It is recommended that you use an SD card with no data or an SD card formatted on this unit.

Note

It is impossible to restore data after formatting the card or erasing the data. Once a card is formatted, all data including those recorded on the PC is erased as well, even if the data were protected with other equipment. Confirm whether the card can be formatted.

CHAPTER PLAYBACK

DVD-VR

- 1 Insert a disc (⇒ 9).
- 2 While “Title View” screen is displayed
Press [▲, ▼] to select the title and press [OPTION].

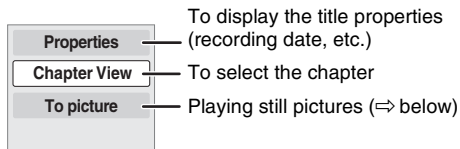

- 3 Press [▲, ▼] to select “Chapter View” and press [OK].
- 4 Press [◀, ▶] to select the chapter and press [OK].

PLAYING STILL PICTURES

JPEG

You can play still pictures recorded onto a BD-RE, DVD-RAM, CD-R/RW and an SD card.

- 1 Insert a disc (⇒ 9) or an SD card (⇒ right).
 - If a disc or an SD card containing data in different file formats is inserted, the file selection menu may be displayed.
SD card:
Press [▲, ▼] to select “Picture (JPEG)” and press [OK].
CD-R/RW:
Press [▲, ▼] to select “JPEG” and press [OK].

e.g.,



e.g.,

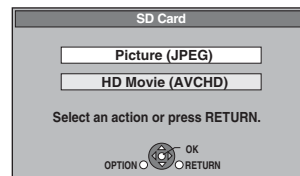

BD-RE, DVD-RAM

- “Album View” screen is displayed
e.g.,

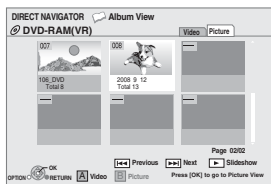

- When the “Title View” screen is displayed, press the [B] button to switch to the “Album View” screen.

- 2 Press [▲, ▼, ▶, ◀] to select the item and press [OK].
e.g.,

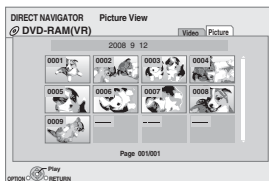

- 3 Press [▲, ▼, ▶, ◀] to select the still picture and press [OK].

CD-R/RW, SD card

- “Picture View” screen is displayed
→ Go to step 3

e.g.,

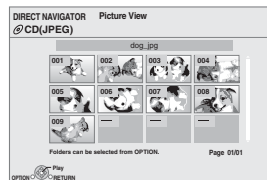

Inserting a card

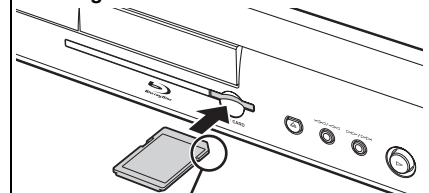

Insert the card label up with the cut-off corner on the right.

- Insert the SD card into the SD card slot.
 - Press on the centre of the card until it clicks into place.

Removing the card

Press on the centre of the card and pull it straight out.

Tips

- Press [◀, ▶] to display the previous or next still picture.
- Press [◀◀, ▶▶] to show other pages.

To return to the previous screen

Press [RETURN].

To exit the screen

Press [TOP MENU/DIRECT NAVIGATOR].

CD-R/RW

Discs containing data in different file formats. To switch from the MP3 menu to JPEG menu, perform steps below.

- 1 Press [FUNCTIONS].
- 2 Press [▲, ▼] to select “Menu” and press [OK].
- 3 Press [▲, ▼] to select “JPEG” and press [OK].

Note

Small-sized still pictures are displayed with a frame.

Useful functions during still picture play

Start Slideshow

You can display still pictures one by one at a constant interval.

■ BD-RE, DVD-RAM

- ① While the "Album View" screen is displayed
Press [▲, ▼, ◀, ▶] to select the album and press [OPTION].
 - ② Press [▲, ▼] to select "Start Slideshow" and press [OK].
- You can also start slideshow by pressing [▶] (PLAY) after selecting the album.

■ CD-R/RW, SD card

- ① While the "Picture View" screen is displayed
Press [OPTION].
- ② Press [▲, ▼] to select "Start Slideshow" and press [OK].

To stop slideshow

Press [■].

Slideshow with music

■ SD card only

If a music CD is inserted in the disc tray while playing slideshows, the music CD starts playing automatically as background music.

- You cannot search or skip on a music CD.
- When the slideshow stops, playback of the music CD also stops.

Slideshow settings

In step ② in "Start Slideshow" above,

- ① Press [▲, ▼] to select "Slideshow settings" and press [OK].
- ② **To change the display interval**
Press [▲, ▼] to select "Display Interval" and press [◀, ▶] to select the interval ("Long", "Normal" or "Short").
 - When a still picture with large number of pixels is played, the display interval may become longer. Even if the setting is changed, the display interval may not become shorter.

To repeat slideshow

- Press [▲, ▼] to select "Repeat Play" and press [◀, ▶] to select "On" or "Off".
- ③ Press [▲, ▼, ◀, ▶] to select "Set" and press [OK].

Rotate

- ① While playing (except for slideshows)
Press [OPTION].
 - ② Press [▲, ▼] to select "Rotate RIGHT" or "Rotate LEFT" and press [OK].
- The rotation information will be stored until the unit is turned off or the media is removed.

Zoom out

This function is only available for small-sized still pictures.

- ① While playing (except for slideshows)
Press [OPTION].
 - ② Press [▲, ▼] to select "Zoom out" and press [OK].
- To cancel "Zoom out", press [▲, ▼] to select "Zoom in" in step ② and press [OK].
 - The zoom-out information will not be stored.

To select the still pictures in another folder

■ BD-RE, DVD-RAM

To switch to another higher folder

(Only if there is a multiple number of higher folders recognizable)

- ① While the "Album View" screen is displayed
Press [OPTION].
- ② Press [▲, ▼] to select "Select folder" and press [OK].

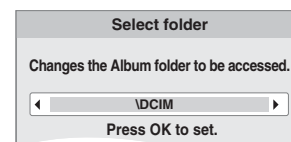

- ③ Press [◀, ▶] to select the higher folder and press [OK].

■ CD-R/RW

- ① While the "Picture View" screen is displayed
Press [OPTION].
- ② Press [▲, ▼] to select "Folder" and press [OK].
- ③ Press [▲, ▼] to select a folder and press [OK].
The "Picture View" screen for the folder appears.

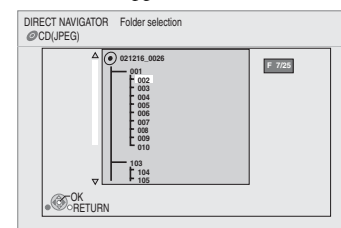

To show the picture properties

While playing
Press [STATUS] twice.

e.g., JPEG on DVD-RAM
Shooting date

| | |
|----------------------|------------|
| Folder - picture No. | 102 - 0001 |
| Date | 11.12.2007 |
| Total | 3/9 |

To exit, press [STATUS].

PLAYING MUSIC

CD MP3

You can play generally available music CD or MP3 files recorded onto a CD-R/RW.

1 Insert a disc. (⇒ 9)

- If a disc containing data in different file formats is inserted, the file selection menu may be displayed. Press [▲, ▼] to select "MP3" and press [OK].

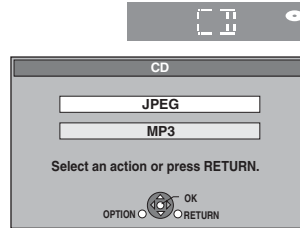

2 Press [▲, ▼] to select the track and press [OK]. → Play starts on the selected track.

"🎵" indicates the track currently playing.

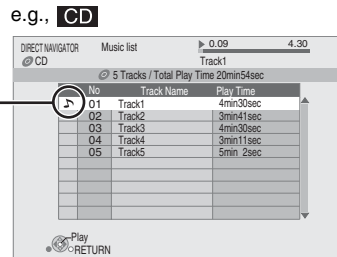

MP3 Playing a track in another folder

- While the "Music list" is displayed
Press [OPTION], press [▲, ▼] to select "Select Folder" and press [OK].

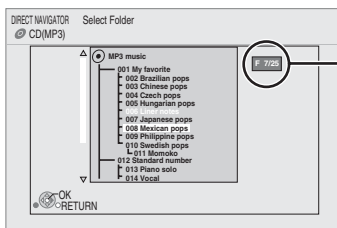

Selected folder No. /Total folders
If the folder has no track, "--" is displayed as folder number.

- Press [▲, ▼] to select a folder and press [OK].
The "Music list" for the folder appears.

Playing music continuously even after turning off power to the television

When the unit is connected to a Panasonic TV (VIERA) that supports HDAVI Control 2 or HDAVI Control 3 and a receiver supports VIERA Link, the unit is turned off if the power to the television is turned off, since "Power off link" (⇒ 16) operates.

The following operations make it possible to keep the power of the unit ON and to play music continuously.

- While playing music
Press [OPTION].
- Press [▲, ▼] to select "TV Power" and press [OK].

⚡ Tips

- Discs containing data in different file formats.
 - To switch from the JPEG menu to MP3 menu, perform steps below.
- Press [FUNCTIONS].
 - Press [▲, ▼] to select "Menu" and press [OK].
 - Press [▲, ▼] to select "MP3" and press [OK].
- You can use search and skip functions. (⇒ 10)
 - When the "Screen Saver Function" is set to "On" (⇒ 21), the screen switches to Screen Saver mode if there is no operation for 10 minutes after starting playback. (Playback continues.)

Note

You cannot select folders that contain no compatible tracks.

⚡ Tip

To return to the previous screen
Press [RETURN].

Notes

- Sound may be discontinued for several seconds when the power to the television is turned off.
- If the operation mentioned left is executed while audio is output from the television, the sound may not be output from the receiver. It is recommended to set the receiver beforehand so that audio will be output from the receiver.

SHOWING FUNCTIONS MENU

Some functions of this unit can be operated from the FUNCTIONS menu.

- Press [FUNCTIONS].
 - Items to be displayed may vary with the media.
- Press [▲, ▼] to select the item and press [OK].
 - Top Menu
 - Menu
 - Playback
 - SD card
 - BD/DVD/CD
 - To Others

Switches to the SD drive.
Switches to the disc drive.
"Setup" (⇒ 19)
"Card Management" (⇒ 11)
"Playlists":

You can play playlists created on DVD-VR.

Press [▲, ▼, ◀, ▶] to select the playlist and press [OK].

e.g.,

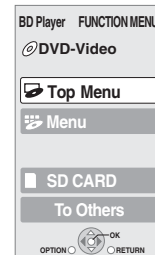

ABOUT MP3/JPEG FILES

| File format | MP3 | JPEG |
|--------------------|--|--|
| Playable media | CD-R/RW ^{*1} | CD-R/RW ^{*1} , DVD-RAM ^{*2} , BD-RE ^{*3} , SD card |
| Extension | Files must have the extension ".mp3" or ".MP3". | Files must have the extension ".jpg" or ".JPG". |
| Picture resolution | – | between 34 × 34 and 5120 × 3840 pixels (sub sampling is 4:2:2 or 4:2:0) |
| Compression rates | 32 kbps to 320 kbps | – |
| Sampling frequency | 44.1 kHz/48 kHz | – |
| Reference | ID3 tags: version 1, 2.2, 2.3, 2.4 ID3 is a tag embedded in MP3 track to provide information about the track. This unit supports the versions listed above but only titles and the names of artists can be displayed. <ul style="list-style-type: none"> If there is a large amount of still picture data etc. within a MP3 file, play may not be possible. | <ul style="list-style-type: none"> MOTION JPEG: not supported SD card: JPEG conforming DCF^{*4} Thawing Time: approx. 2 sec. (7M pixels) |

- English alphabet and Arabic numerals are displayed correctly. Other characters may not be displayed correctly.
- The display order on this unit may differ from how the order is displayed on a computer.
- Depending on how you create the media (writing software), files and folders may not play in the order you numbered them.
- This unit is not compatible with packet-write format.
- Depending on the recording conditions, the media may not play.
- Operation may take time to complete when there are many files and/or folders and some files may not display or be playable.

*1: ISO9660 level 1 or 2 (except for extended formats), Joliet
This unit is compatible with multi-session.

*2: Discs must conform to UDF 2.0.

*3: Discs must conform to UDF 2.5.

*4: Design rule for Camera File system: unified standard established by Japan Electronics and Information Technology Industries Association (JEITA).

Structure of MP3 and still pictures (JPEG) folders

You can play MP3 and still pictures (JPEG) with this unit by making folders on disc as shown (⇒ right).

- Folder structure created on a DVD-RAM, BD-RE or an SD card is not displayed.

MP3 files and folders in CD-R/RW

Prefix with 3-digit numbers in the order you want to play them.

Still pictures (JPEG) in CD-R/RW

Files inside a folder are displayed in the order they were updated or taken.

When the highest level folders are "DCIM" folders, they are displayed first on the tree.

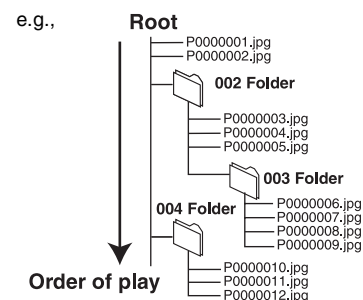

LINKED OPERATIONS WITH THE TV

What is linked operations with the TV?

This unit has a convenient function that offers linked operations that control equipment through HDMI. You can use this function by connecting TV and/or amplifier/receiver with an HDMI cable. See the operating instructions for connected equipment for operational details.

- With linked operations with the TV, you can do the following:
 - Automatic input switching
 - Power on link
 - Power off link
 See below for the details.
- This unit offers linked operations with a Panasonic TV with VIERA Link.
- Please refer to individual manuals for other manufacturers' equipment supporting linked operations through HDMI function.

■ Preparation

- Connect this unit to your TV or a receiver with an HDMI cable (⇒ 4-5).
- Set "HDMI Control" to "On" (⇒ 21).
(The default setting is "Off".)
- Set the linked operations on the connected equipment (e.g., TV).
- Turn on all connected equipments and select this unit's input channel on the connected TV so that the linked operations work properly.

Also when the connection or settings are changed, repeat this procedure.

What you can do with linked operations with the TV

■ Automatic input switching

When the following operations are performed, the television will automatically switch the input channel and display the corresponding action.

- When play starts on the unit
- When an action that uses the display screen is performed (e.g., Direct Navigator screen)
- BD-V** **DVD-V** When playback stops, the TV will automatically return to TV tuner mode.

■ Power on link

When the television is off and the following operations are performed, the television will automatically turn on and display the corresponding action.

- When play starts on the unit
- When an action that uses the display screen is performed (e.g., Direct Navigator screen)

■ Power off link

All connected equipment compatible with linked operation through HDMI, including this unit, automatically turns off when you switch the television off.

- This unit automatically turns off even during playback or any other operation.

■ Playing music continuously even after turning off power to the television (⇒ 14)

Notes

- When [▶] (PLAY) is pressed on this unit for "Automatic input switching" or "Power on link", the playback image is not immediately displayed on the screen and it may not be possible to watch the contents from where playback started.
- In this case, press [◀◀] or [▶▶] to go back to where playback started.

Easy control only with Panasonic TV (VIERA) remote control

If you connect this unit to a TV that has "HDAVI Control 2" or "HDAVI Control 3" function with an HDMI cable, you can operate this unit using the following buttons on the TV remote control:

[▲], [▼], [◀], [▶], [OK], [RETURN], [EXIT], [OPTION] and coloured buttons ([EXIT]: Exit the screen)

Use the remote control for this unit to operate any other buttons (numbered buttons, etc.) that are not listed above.

- Refer to the TV operating instructions for operating TV.

■ Using the FUNCTIONS menu to operate this unit

By using the TV remote control, you can play media e.g., using the FUNCTIONS menu.

- Press the button for VIERA Link on the remote control.
- Select the player.
 - The FUNCTIONS menu is displayed.

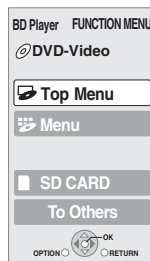

When you want to leave the TV on and set only this unit to standby mode

Press [⏻/|] **STANDBY/ON** on this unit's remote control and set to standby mode.

When not using linked operations with the TV

Set "HDMI Control" in the Setup menu to "Off". (⇒ 21)

■ Using the OPTION menu to operate this unit

By using the TV remote control, you can play discs using the "Control Panel" and display the Top Menu (for BD-Video and DVD-Video) or Pop-up Menu (for BD-Video).

- Press [OPTION].

→ This can also be displayed by using the VIERA menu screen.

Note

You cannot use the OPTION menu while the Top Menu for BD-Video or DVD-Video is displayed.

- Select an item, then press [OK].

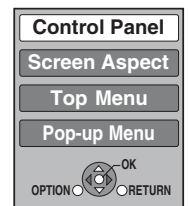

| | |
|---|---|
| Control Panel | Control Panel is displayed. Follow the indications on the screen. |
| Screen Aspect | (⇒ 10) |
| Top Menu BD-V AVCHD DVD-V | Top menu is displayed. |
| Menu DVD-V | Menu is displayed. |
| Pop-up Menu BD-V AVCHD | Pop-up menu is displayed. |
| Rotate RIGHT JPEG | Rotate the still picture. |
| Rotate LEFT JPEG | |
| Zoom in JPEG | Enlarge or shrink the still picture. |
| Zoom out JPEG | |

SETTINGS

CHANGING SETTINGS WITH THE ON-SCREEN MENU

On-screen menu operations

- 1 Press [ON SCREEN].
- 2 Press [▲, ▼] to select the menu and press [▶].
- 3 Press [▲, ▼] to select the item and press [▶].
- 4 Press [▲, ▼] to select the setting.

e.g., BD-Video

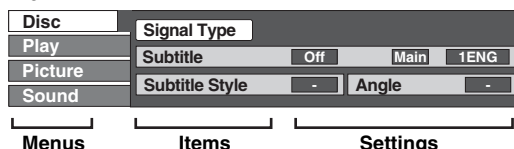

Note

Depending on the condition of the unit (playing, stopped, etc.) and disc contents, there may be some items that you cannot select or change.

Tip

Some items can be changed by pressing [OK].

To exit the on-screen menu

Press [ON SCREEN].

What you can change with the on-screen menu

| Menus | Items | Settings and details |
|-------|----------------|---|
| Disc | Signal Type | BD-V <ul style="list-style-type: none"> • Primary Video Video: The video recording method appears. (⇒ below, Video recording method) Soundtrack: Select the type of audio or language. (⇒ below, Language, Audio attribute) • Secondary Video Video: Select on/off of images. The video recording method appears. (⇒ below, Video recording method) Soundtrack: Select on/off of audio and the language. (⇒ below, Language, Audio attribute) |
| | Video | AVCHD The video recording method appears. (⇒ below, Video recording method) |
| | Soundtrack | AVCHD DVD-V Select the type of audio or language. (⇒ below, Language, Audio attribute) DVD-VR The audio attributes appear. (⇒ below, Audio attribute) |
| | Subtitle | BD-V AVCHD DVD-V Turn the subtitle on/off and select the language. (⇒ below, Language) DVD-VR (Only discs that contain subtitle on/off information) Turn the subtitle on/off. |
| | Subtitle Style | BD-V Select the subtitle style. |
| | Audio channel | DVD-VR (⇒ 10, Changing audio during play) |
| | Angle | BD-V DVD-V Select the number of the angle. |

Some items may be changed only on the disc specific menu. (⇒ 9, 11)

| Language | | |
|----------------|-----------------|----------------|
| ENG: English | DAN: Danish | THA: Thai |
| FRA: French | POR: Portuguese | POL: Polish |
| DEU: German | RUS: Russian | CES: Czech |
| ITA: Italian | JPN: Japanese | SLK: Slovak |
| ESP: Spanish | CHI: Chinese | HUN: Hungarian |
| NLD: Dutch | KOR: Korean | FIN: Finnish |
| SVE: Swedish | MAL: Malay | *: Others |
| NOR: Norwegian | VIE: Vietnamese | |

| Audio attribute | |
|--|--------------------|
| LPCM/ Digital/ Digital+/ TrueHD/DTS/DTS-HD/MPEG | Signal type |
| ch (channel) | Number of channels |
| k (kHz) | Sampling frequency |
| b (bit) | Number of bits |

| Video recording method | |
|------------------------|--|
| MPEG-2 | This is a standard for compressing and decompressing colour motion pictures efficiently. This compression method is used for DVDs, etc. |
| MPEG-4 AVC VC-1 | These are standards for compressing and decompressing colour motion pictures more efficiently than MPEG-2 and used for Blu-ray Discs, etc. |

| Menus | Items | Settings and details |
|---------|------------------|---|
| Play | Repeat Play | <p>(Only when the elapsed time is being displayed on the unit's display.) Selects the item which you want to repeat. The items displayed differ depending on the type of disc.</p> <ul style="list-style-type: none"> • All tracks All tracks • Chapter Chapter • Playlists Playlist • Title Title • One track Track • Off <p>Select "Off" to cancel.</p> |
| | Random | <p>CD MP3</p> <p>While playing, press [▲, ▼] to select "On". Random playback starts from the next track.</p> <ul style="list-style-type: none"> • On • Off |
| Picture | Mode | <p>BD-V AVCHD DVD-VR DVD-V</p> <p>Select the picture quality mode during play.</p> <ul style="list-style-type: none"> • Normal: Default setting • Soft: Soft picture with fewer video artifacts • Fine: Details are sharper • Cinema: Mellows movies, enhances detail in dark scenes. • User: You can make further adjustments. (⇒ below) <p>① Press [▶] to select "Picture Adjustment" and press [OK]. ② Select the item using [▲, ▼] and adjust it with [◀, ▶].</p> <p>Contrast: Increases the contrast between light and dark parts of the picture (-7 to +7). Brightness: Brightens the picture (0 to +15). Sharpness: Adjusts the sharpness of the edges of the horizontal lines (-6 to +6). Colour: Adjusts the shade of the picture's colour (-7 to +7). Gamma: Adjusts the brightness of dark portions of the screen (0 to +5). 3D NR: Reduces the rough noise in the background to give a greater feeling of depth (0 to +4). When "BD-Video 24p Output" is set to "On", this function may not operate. (⇒ 21) Integrated NR: Smooths block noise and reduces the smudging that appears around contrasting sections of the picture (0 to +3).</p> |
| | Progressive | <p>If images are stretched from right to left, set to "Off". [Only when you have selected "576p/480p" in "Component Resolution" (⇒ 21)]</p> <ul style="list-style-type: none"> • Depending on the type of television used, the video may be stretched horizontally when video is output in progressive mode. When this occurs, select "Off" and the video will then be output as "576i/480i". • This setting will be fixed to "On" if you connect with an HDMI cable and set "HDMI Video Mode" to "On" (⇒ 21). <p>Note</p> <p>When connected to a regular television (CRT: Cathode ray tube) or a multi-system television using PAL mode, even if it is progressive compatible, progressive output can cause some flickering. Turn off "Progressive" if you are concerned about it.</p> |
| | Transfer | <p>[When "Progressive" (⇒ above) is set to "On".] Select the method of conversion for progressive output to suit the type of material being played (⇒ 29, Film and video).</p> <ul style="list-style-type: none"> • Auto (normal): Automatically detects the film and video content, and appropriately converts it. • Video: Select when using "Auto", and the content is distorted. |
| Sound | Dialog Enhancer* | <p>BD-V AVCHD DVD-VR DVD-V (3 channels or more only, including a centre channel)</p> <p>The volume of the centre channel is raised to make dialog easier to hear.</p> <ul style="list-style-type: none"> • On • Off |

* This function is effective for audio from the HDMI terminal or the DIGITAL AUDIO OUT terminal only when "Digital Audio Output" is set to "PCM". (However, in this case, audio is output as 2ch from the DIGITAL AUDIO OUT terminal.)

CHANGING THE UNIT'S SETTINGS

Change the unit's settings if necessary. The settings remain intact even if you switch the unit to standby.

Setup menu operations

- 1 While stopped
Press [SETUP].
- 2 Press [▲, ▼] to select the menu and press [OK].
- 3 Press [▲, ▼] to select the item and press [OK].
If there are any other items, repeat these steps.
- 4 Press [▲, ▼, ◀, ▶] to select the option and press [OK].

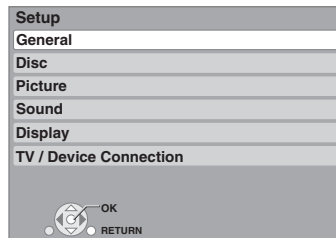

Note

There may be differences in operation methods. If this happens, follow the on-screen instructions for the operation.

☀ Tips

To return to the previous screen

Press [RETURN].

To exit the screen

Press [SETUP].

Summary of settings

Underlined items are the factory presets.

■ "General"

| | | |
|---|-------|-------------|
| Easy Setting You can execute basic setting (TV Aspect). | • Yes | • <u>No</u> |
| Default Settings This returns all values in the Setup menu and the on-screen menu, except for "DVD-Video Ratings" and "BD-Video Ratings" to the default settings. | • Yes | • <u>No</u> |







■ "Disc"

| | | | |
|--|--|--|---|
| DVD-Video Ratings Set a ratings level to limit DVD-Video play. | Follow the on-screen instructions. Enter a 4-digit password with the numbered buttons when the password screen is shown. It will be the common password for both "DVD-Video Ratings" and "BD-Video Ratings". • Do not forget your password. | <ul style="list-style-type: none"> • <u>8 No Limit</u>: All DVD-Video can be played. • 1 to 7: Prohibits play of DVD-Video with corresponding ratings recorded on them. • 0 Lock All: Prohibits play of all DVD-Video. • Unlock Player • Change Level | <ul style="list-style-type: none"> • Change Password • Temporary Unlock |
| BD-Video Ratings Set an age limit of BD-Video play. | | <ul style="list-style-type: none"> • <u>No Limit</u>: All BD-Video can be played. • 0 to 254 year(s): Prohibits play of BD-Video with corresponding ratings recorded on them. • Unlock Player • Change Level | <ul style="list-style-type: none"> • Change Password • Temporary Unlock |
| Soundtrack Preference | Choose the language for audio, subtitle and disc menus. <u>BD-V</u> <u>DVD-V</u> • Some discs start in a certain language despite any changes you make here. | <ul style="list-style-type: none"> • <u>English</u> • Italian • Original: The original language of each disc will be selected. • Other **** | <ul style="list-style-type: none"> • German • Spanish • French |
| Subtitle Preference | <ul style="list-style-type: none"> • When the selected language is not available on the disc, the default language is played. There are discs where you can only switch the language from the menu screen. (⇒ 9, 11) • Enter a code (⇒ 28) with the numbered buttons when you select "Other ****". | <ul style="list-style-type: none"> • <u>Automatic</u>: If the language selected for "Soundtrack Preference" is not available, subtitles of that language will automatically appear if available on that disc. • English • Spanish | <ul style="list-style-type: none"> • German • Other **** • French • Italian |
| Menu Preference | | <ul style="list-style-type: none"> • <u>English</u> • Spanish | <ul style="list-style-type: none"> • German • Other **** • French • Italian |

■ "Picture"

| | |
|--|---|
| Still Mode <u>BD-V</u> <u>AVCHD</u> <u>DVD-V</u> Select the type of picture shown when you pause playback (⇒ 29, Frames and fields). | <ul style="list-style-type: none"> • <u>Automatic</u> • Field: Select if jittering occurs when "Automatic" is selected. (The picture is coarser.) • Frame: Select if small text or fine patterns cannot be seen clearly when "Automatic" is selected. (The picture is clearer and finer.) |
| Seamless Play <u>DVD-VR</u> Select the play mode between playlist chapter segments and partially deleted titles. | <ul style="list-style-type: none"> • <u>On</u>: The chapters in playlists are played seamlessly. This does not work while searching or when there are several audio types included on the playlist. Additionally, the positioning of chapter segments may change slightly. • Off: The points where chapters in playlists change are played accurately, but the picture may freeze for a moment. |
| NTSC Contents Output Select PAL60 or NTSC output when playing NTSC discs. | <ul style="list-style-type: none"> • <u>NTSC</u>: NTSC discs are played as NTSC. • PAL60: Select if picture is not displayed correctly when "NTSC" is selected. |

■ “Sound”

| | | |
|--|--|--|
| <p>Dynamic Range Compression</p> <p>BD-V AVCHD DVD-V (Dolby Digital, Dolby Digital Plus and Dolby TrueHD only) Change the dynamic range (⇒ 29) for late night viewing.</p> | | <ul style="list-style-type: none"> • On • <u>Off</u> |
| <p>Digital Audio Output</p> <ul style="list-style-type: none"> • Press [OK] to show the following settings. | | |
| <p>Priority setting</p> <ul style="list-style-type: none"> • Select priority items for “Digital Audio Output”. | | <ul style="list-style-type: none"> • Secondary Audio: “BD-Video Secondary Audio” is set to “On”, and “Digital Audio Output” is fixed to “PCM”. • Audio Quality: “Digital Audio Output” is set to “Bitstream”, and “BD-Video Secondary Audio” is fixed to “Off”. <ul style="list-style-type: none"> – If the connected equipment can only decode Dolby Digital and DTS, Dolby Digital Plus, Dolby TrueHD, and DTS-HD will be output as Dolby Digital or DTS. – If the connected equipment can only decode one of either Dolby Digital and DTS, please select “User” and set whichever cannot be decoded to “PCM”. • User: Items in “Digital Audio Output” can be set individually. However, these have restrictions, as set out in Regarding “User” setting of “Priority setting” below. |
| <p>Dolby D/Dolby D+/Dolby TrueHD</p> <p> DOLBY DIGITAL</p> <p> DOLBY DIGITAL PLUS  DOLBY TRUEHD</p> <hr/> <p>DTS/DTS-HD</p> <p> DOLBY DIGITAL SURROUND  DTS Digital Surround</p> <p> DTS-HD High Resolution Audio  DTS-HD Master Audio</p> | | <p>Notes</p> <ul style="list-style-type: none"> • Not making the proper settings may result in noise. • If the unit is connected with the HDMI AV OUT terminal, the specifications of the connected equipment take preference over these items may not be output (e.g., when a television is connected, the HDMI audio output of this unit is limited to down-mixed 2ch.) |
| <p>MPEG Audio</p> | | <ul style="list-style-type: none"> • Bitstream: When connected to equipment with a built-in MPEG decoder. • PCM: When connected to equipment without a built-in MPEG decoder. |
| <p>BD-Video Secondary Audio BD-V</p> <p>Turn on/off the clicking sound on the menu and audio with secondary video in picture-in-picture mode. (⇒ 11)</p> | | <ul style="list-style-type: none"> • On: The primary audio and secondary audio are mixed and output. The sampling frequency is converted to 48 kHz. • Off: The clicking sound on the menu and secondary audio are not output. |
| <p>PCM Down Conversion</p> <p>Select how to output audio with a sampling frequency of 96 kHz.</p> <ul style="list-style-type: none"> • Signals are converted to 48 kHz despite the settings across in the following cases: <ul style="list-style-type: none"> – when the signals have a sampling frequency of over 96 kHz – when the disc has copy protection – when “BD-Video Secondary Audio” is set to “On” | | <ul style="list-style-type: none"> • On: Signals are converted to 48 kHz. (Choose when the connected equipment cannot process signals with sampling frequency of 96 kHz.) • Off: Signals are output as 96 kHz. (Choose when the connected equipment can process signals with sampling frequency of 96 kHz.) |

Note

Regarding Audio Output Formats when selecting “User” from “Priority setting”

Refer to the following table for audio output.

- DTS-HD means DTS-HD High Resolution Audio or DTS-HD Master Audio in the following table.
- “The original format” means it will be output in the audio formats of the disc.
- When Secondary Audio is On, the audio output will be changed according to the setting of Dolby D/Dolby D+/Dolby True HD.
 - When the setting of Dolby D/Dolby D+/Dolby True HD is Bitstream, the audio output as Dolby Digital.
 - When the setting of Dolby D/Dolby D+/Dolby True HD is PCM, the audio output as PCM.
- When playing BD-Video without secondary audio or clicking sound, the audio is output as the same format as if “BD-Video Secondary Audio” was set to “Off”.
- The settings emphasized in bold letters are recommended to output the high specification audio of Dolby Digital Plus, Dolby TrueHD, DTS-HD High Resolution Audio and DTS-HD Master Audio as the original format.

| This unit | | | | BD-video | Audio formats are output as : | | | |
|-----------------------------------|------------------|-----------------------------------|--|---|-------------------------------|---|---------------|-----------------|
| Setting of “Digital Audio Output” | | | | With or without secondary audio/ clicking sound | HDMI AV OUT | DIGITAL AUDIO OUT (COAXIAL and OPTICAL) | | |
| (Audio format of playback disc) | Bitstream ↔ PCM | BD-Video Secondary Audio On ↔ Off | Dolby D/Dolby D+/Dolby True HD Bitstream ↔ PCM | | | | | |
| Dolby D/Dolby D+/Dolby True HD | Bitstream | On | / | With | Dolby Digital | Dolby Digital | | |
| | | Off | | With or Without | The original format | Dolby Digital | | |
| | On or Off | | With or Without | 5.1ch PCM | 2ch PCM | | | |
| DTS/DTS-HD | Bitstream | On | / | With | Dolby Digital | Dolby Digital | | |
| | | | | Without | The original format | DTS | | |
| | | With | 5.1ch PCM | 2ch PCM | | | | |
| | | Without | The original format | DTS | | | | |
| | Off | Bitstream or PCM | With or Without | The original format | DTS | | | |
| | | | | | On | With | Dolby Digital | Dolby Digital |
| | | | | | | Without | 5.1ch PCM | 2ch PCM |
| PCM | On | / | With or Without | 5.1ch PCM | 2ch PCM | | | |
| | | | Off | Bitstream or PCM | 5.1ch PCM | 2ch PCM | | |
| MPEG | Bitstream | On | / | With | Dolby Digital | Dolby Digital | | |
| | | | | Without | The original format | MPEG | | |
| | | With | 5.1ch PCM | 2ch PCM | | | | |
| | | Without | The original format | MPEG | | | | |
| | Off | Bitstream or PCM | With or Without | The original format | MPEG | | | |
| | | | | | On | With | Dolby Digital | Dolby Digital |
| | | | | | | Without | 5.1ch PCM | 2ch PCM |
| | | | | | PCM | On | / | With or Without |
| Off | Bitstream or PCM | 5.1ch PCM | 2ch PCM | | | | | |

The unit outputs Dolby Digital or DTS Digital Sound for Dolby Digital Plus/Dolby True HD, DTS-HD, or outputs as “the original format” in the following cases:

- The connected device does not support Dolby Digital Plus, Dolby TrueHD, DTS-HD High Resolution Audio or DTS-HD Master Audio.
- Since multiple devices are connected using HDMI cables, operations on the device are restricted.

Regarding 7.1ch LPCM

The settings described below are recommended to output as the original format.

- Connect the unit with the HDMI AV OUT terminal^{*1}
- Set “BD-Video Secondary Audio” to “Off”. (Otherwise down-mixed 5.1ch PCM will be output from the HDMI AV OUT terminal)

*1 Down-mixed 2ch PCM is output from the DIGITAL AUDIO OUT terminal, regardless of the “BD-Video Secondary Audio” setting.

■ “Display”

| | |
|---|---|
| <p>On-screen Messages Choose whether to show status messages automatically.</p> | <ul style="list-style-type: none"> • <u>Automatic</u> • Off |
| <p>Screen Saver Function This is to prevent burn-in on the screen. • When this is set to “On”, the masked-off area on the screen becomes gray. [Only when connecting with an HDMI cable or a component video cable and “HDMI Video Format” (⇒ below) is set to any other mode than “576p/480p”, or “Component Resolution” (⇒ below) is set to “720p” or “1080i”]</p> | <ul style="list-style-type: none"> • <u>On</u>: If there is no operation for 10 minutes or more, the displayed screen switches to the other states automatically. <ul style="list-style-type: none"> - When the Direct Navigator or FUNCTIONS menu is displayed, the display returns to the screen saver mode. - When CD or MP3 is played, the display returns to the screen saver mode. (Playback continues.) - When still pictures are shown (except for slideshows), the display returns to the Direct Navigator screen. • Off |
| <p>FL Display Changes the brightness of the unit’s display.</p> | <ul style="list-style-type: none"> • <u>Bright</u> • Dim: The display is dimmed. • Automatic: The display is dimmed during playback and bright except playback. |
| <p>SD Card LED Control Set the lighting method for the lamp by the SD card slot.</p> | <ul style="list-style-type: none"> • <u>On</u> • SD inserted: When this unit is turned on and SD card is inserted, the lamp is lighted. • Off |
| <p>Software License</p> | <p>Information about the software used by this unit is displayed.</p> |

■ “TV/Device Connection”

| | |
|---|--|
| <p>TV Aspect Set to match the type of television connected.</p> | <p>When connected to a 4:3 aspect television:</p> <ul style="list-style-type: none"> • 4:3 Pan & Scan: Video recorded for a widescreen is played as Pan & Scan (unless prohibited by the producer of the disc). When playing BD-Video, video is output as “4:3 Letterbox”. • 4:3 Letterbox: Video recorded for a widescreen is played in the letterbox style. <p>When connected to a 16:9 widescreen television:</p> <ul style="list-style-type: none"> • 16:9: Video recorded for 4:3 aspect screen is displayed as a 4:3 ratio image in the centre of the screen. • 16:9 Full: Video recorded for 4:3 aspect screen is displayed as a horizontally stretched 16:9 image. |
| <p>HDMI Connection • Press [OK] to show the following settings.</p> | |
| <p>HDMI Video Mode Select “On” when video is output from HDMI AV OUT terminal.</p> | <ul style="list-style-type: none"> • <u>On</u>: Images are output from the HDMI terminal in the resolution set in “HDMI Video Format”. Video from COMPONENT VIDEO OUT terminal is output as “576i/480i”. • Off: Images are not output from the HDMI terminal. Video from COMPONENT VIDEO OUT terminal is output in the resolution set in “Component Resolution” explained below. |
| <p>HDMI Video Format The items supported by the connected devices are indicated on the screen as “*”. When any item without “*” is selected, the images may be distorted.</p> | <ul style="list-style-type: none"> • <u>Automatic</u>: Automatically selects the output resolution best suited to the connected television (1080p, 1080i, 720p or 576p/480p). • 576p/480p • 720p • 1080i • 1080p <p>When the unit is connected to an amplifier/receiver that does not support the resolution set on the unit, the video cannot be output properly. In this case, use the HDMI cable to connect the unit to the TV and then connect the unit to the amplifier/receiver using a cable other than HDMI.</p> |
| <p>BD-Video 24p Output When playing BD-Video recorded in 24 frames, this unit displays each frame at 1/24 second intervals—the same interval originally shot with the film movie. • This item can be set only when the unit is connected to a TV with an HDMI terminal that supports 1080/24p input.</p> | <ul style="list-style-type: none"> • <u>On</u>: Images in 24p are output in 24p as they are. (This is effective only when “HDMI Video Format” is set to “Automatic” or “1080p” and “TV Aspect” is set to “16:9” or “16:9 full”.) However, <ul style="list-style-type: none"> - when video is being output at 24 frames, images from any other terminal than the HDMI terminal may not be output properly. - when images other than 24p are played, images are output at 60p. • Off |
| <p>HDMI Output Range Effective when connected to a device that only supports RGB output.</p> | <ul style="list-style-type: none"> • <u>Standard</u> • Enhanced: When the black and white images are not distinct. |
| <p>HDMI Audio Output This setting selects whether or not to output audio from HDMI.</p> | <ul style="list-style-type: none"> • <u>On</u> • Off: When the TV is connected to this unit using an HDMI cable, and this unit is also connected to other devices, such as an amplifier/receiver using an optical digital audio cable or a coaxial cable. |
| <p>HDMI Control Set to use linked operations with the TV function when connected with an HDMI cable to a device that supports the same function.</p> | <ul style="list-style-type: none"> • <u>On</u>: Select when you want to use linked operations with the TV. • Off: Select when you do not want to use linked operations with the TV. |
| <p>Component Resolution This sets the video output resolution when using the component video terminal.</p> | <ul style="list-style-type: none"> • 576i/480i • 576p/480p • 720p • 1080i <p>480i, 480p: When playing NTSC discs 576i, 576p: When playing PAL discs Even if you select “720p” or “1080i”, the video output resolution is restricted to “576p/480p” when DVD-Video and BD-Video discs recorded at a rate of 50 frames per second is output from the COMPONENT VIDEO OUT terminals.</p> |
| <p>Speaker You can set the unit to output the best possible sound for your speakers.</p> | <ul style="list-style-type: none"> • <u>Multi Channel</u>: When using 3 or more speakers. (⇒ 22) • 2 Channel: When using two speakers. 2ch down-mix audio are output from Front L and Front R. |
| <p>TV System Change the setting to match the equipment you are connecting with. • If picture output is not smooth, change the setting. • When NTSC contents are played, they are outputted in the signal format specified in the “NTSC Contents Output”, irrespective of the settings here.</p> | <ul style="list-style-type: none"> • <u>NTSC</u>: Select when connecting to a NTSC television. • <u>PAL</u>: Select when connecting to a PAL or multi-system television. |

Changing the speaker setting to suit your speakers

When connecting to an amplifier/receiver to enjoy multi-channel surround sound, use the following settings on this unit if they cannot be set on the amplifier/receiver. The settings are not effective when outputting bitstream signals.

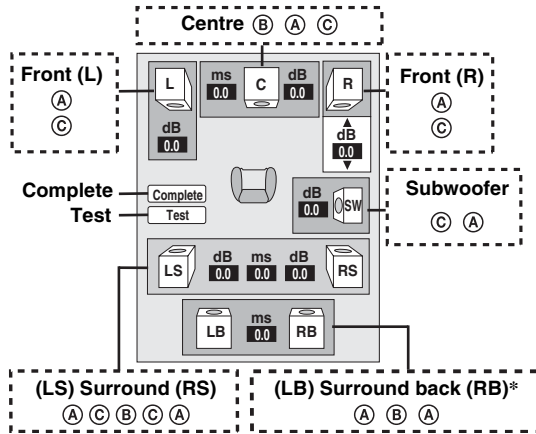

* Surround back channel is enabled only when the unit is connected to an amplifier/receiver supporting HDMI 7.1 channel audio.

Speaker presence and size (A)

- Press [▲, ▼, ◀, ▶] to select the speaker icon (A) and press [OK].
- Press [▲, ▼] to select the setting and press [OK].

Icon examples:

Surround speaker (LS)

- Large:** Select when the speaker supports low-frequency (under 100 Hz) reproduction.



- Small:** Select when the speaker does not support low-frequency reproduction. In order to make an ideal listening environment, settings of speaker sizes may be automatically adjusted.

For example, if the subwoofer is set to "No", the front speakers will automatically be set to "Large". (In this case, we recommend connecting a speaker that can reproduce bass below 100 Hz.)

Delay time (B)

For optimum listening with 7.1/5.1-channel sound, all the speakers, except for the subwoofer, should be the same distance from the seating position.

If you have to place the centre, surround and surround back speakers closer to the seating position, adjust the delay time to make up for the difference.

If either distance (D) or (F) is less than (E), find the difference in the relevant table and change to the recommended setting.

- Press [▲, ▼, ◀, ▶] to select the delay time box (B) and press [OK].
- Press [▲, ▼] to select the setting and press [OK].

5.1ch speaker connection

Approximate room dimensions

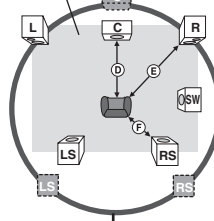

7.1ch speaker connection

Approximate room dimensions

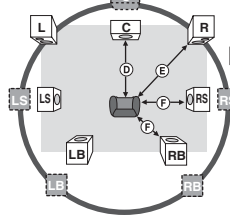

- Actual speaker position
- Ideal speaker position
- (D) (E) (F) : Primary listening distance

Circle of constant primary listening distance

(D) Centre speaker

| Difference | Setting |
|------------------------------|---------|
| Approx. 34 cm (1 ft. 1 in.) | 1.0 ms |
| Approx. 68 cm (2 ft. 2 in.) | 2.0 ms |
| Approx. 102 cm (3 ft. 4 in.) | 3.0 ms |
| Approx. 136 cm (4 ft. 5 in.) | 4.0 ms |
| Approx. 170 cm (5 ft. 6 in.) | 5.0 ms |

(F) Surround/Surround back speakers

| Difference | Setting |
|-------------------------------|---------|
| Approx. 170 cm (5 ft. 6 in.) | 5.0 ms |
| Approx. 340 cm (11 ft. 1 in.) | 10.0 ms |
| Approx. 510 cm (16 ft. 8 in.) | 15.0 ms |

Channel balance (C)

This does not work when connected with the HDMI terminal and "HDMI Audio Output" (⇒ 21) is set to "On".

- Select "Test" and press [OK].
A test signal is output.

Front (L) → Centre → Front (R) → Surround (RS)

↑
Surround (LS) ← Surround Back (LB)* ← Surround Back (RB)*

* Test signal is output only when the unit is connected using HDMI AV OUT terminal.

- While listening to the test signal, press [▲, ▼] to adjust the volume of each speaker.
Front speakers: 0.0 to -6.0 dB
Centre and surround speakers: 0.0 to -12.0 dB
 - You cannot adjust the volume of surround back speakers.
- Press [OK].
The test signal stops.
 - No signal is output for the subwoofer. To adjust its volume, play something, then return to this screen to adjust to suit your taste.
- Press [▲, ▼, ◀, ▶] to select "Complete" and press [OK].

REFERENCE

FREQUENTLY ASKED QUESTIONS

■ Setup

| | | Page |
|--|---|--------|
| What do I need to play multi channel surround sound? | <ul style="list-style-type: none"> Connect the appropriate amplifier/receiver to the HDMI terminal, the DIGITAL AUDIO OUT terminal (OPTICAL, COAXIAL), or the 5.1ch AUDIO OUT terminal on this unit. | 5, 6 |
| How do I set this unit to play 7.1ch surround sound? | <ul style="list-style-type: none"> After connecting this unit to an amplifier/receiver compatible with Dolby Digital Plus, Dolby TrueHD, DTS-HD and 7.1ch LPCM using an HDMI cable, set the items in the Setup menu as follows. <ul style="list-style-type: none"> “Priority setting”: “Audio Quality” “Speaker”: “Multi-Channel” | 20, 21 |
| Can headphones and speakers be directly connected to this unit? | <ul style="list-style-type: none"> You cannot directly connect them to this unit. Connect through the amplifier/receiver, etc. | 5, 6 |
| My television has S VIDEO IN terminal, COMPONENT VIDEO IN terminals and HDMI IN terminal. Which should I connect with? | <ul style="list-style-type: none"> The different levels of picture quality input are listed below in order from highest to lowest. HDMI IN→COMPONENT VIDEO IN→S VIDEO IN→VIDEO IN. However, it will take longer for the picture output to start up when this unit is connected with the HDMI IN terminal. | – |

■ Disc

| | | |
|---|--|-----------------|
| Can I play BD-Video and DVD-Video bought in another country? | <ul style="list-style-type: none"> You cannot play: <ul style="list-style-type: none"> BD-Video discs that do not include region code “B”. DVD-Video discs that do not include region number “4” or “ALL”. Refer to the cover of this owner’s manual for more information about your region code and number. Refer to the disc’s jacket for more information. | i |
| Can BD-Video/DVD-Video that does not have a region code/number be played? | <ul style="list-style-type: none"> The region management information for BD-Video/DVD-Video indicates that the disc conforms to industry standards. You cannot play discs that do not conform to industry standards or do not have a region code or number. | – |
| Please tell me about disc compatibility with this unit. | <ul style="list-style-type: none"> This unit plays BD-Video, DVD-Video, CD, BD-RE (BD-RE Recording Format/JPEG), BD-R (BD-R Recording Format), DVD-RAM (DVD Video Recording format/AVCHD format/JPEG), DVD-R/RW (DVD-Video format, DVD Video Recording format and AVCHD format), DVD-R DL (DVD-Video format, DVD Video Recording format and AVCHD format), DVD+R, DVD+RW and DVD+R DL. This unit also plays CD-R/RW discs which have been recorded in one of the following standards: CD-DA, MP3 and still pictures (JPEG). Close the session after recording. You cannot write to a disc with this unit. | 2 2, 15 – |

■ SD card

| | | |
|--|--|--------------|
| What kinds of operations are available on the SD card slot on this unit? | <ul style="list-style-type: none"> The following operations are available. <ul style="list-style-type: none"> Playback JPEG data recorded with a digital camera etc. Playback AVCHD motion pictures recorded with High Definition Camcorder If a BD-Video disc supporting this function is used, it is possible to copy secondary video recorded on the disc to the card and play it back together with the images on the disc. (Virtual package) | – – 11 |
| What kinds of cards can be used? | <ul style="list-style-type: none"> SD Memory Cards (from 8 MB to 2 GB), SDHC Memory Cards (from 4 GB to 16 GB), miniSD Cards*, and microSD Cards* can be used. * A miniSD Card and a microSD Card must be used in the attached adaptor. BD-V To play the virtual package, it is recommended that you use a card that supports SD Speed Class Rating Class 2 and has 256 MB or more free space. | 3 – |

TROUBLESHOOTING GUIDE

Before requesting service, make the following checks.

The following do not indicate a problem with this unit:

- Regular disc rotating sounds.
- Image disturbance during search.

■ To reset this unit

| | | Page |
|---|--|------|
| To restore the unit if it freezes due to one of the safety devices being activated | <ul style="list-style-type: none"> • Press and hold [STANDBY/ON] on the main unit for 3 seconds. (The settings remain unchanged.) | – |
| To return all settings other than some settings to the factory preset | <ul style="list-style-type: none"> • Select “Yes” in “Default Settings” in the Setup menu. This returns all values in the Setup menu and the on-screen menu, except for “DVD-Video Ratings” and “BD-Video Ratings” to the default settings. | 19 |
| To return to the factory preset (No setting) | <ul style="list-style-type: none"> • Reset the unit as follows: <ol style="list-style-type: none"> ① Press [STANDBY/ON] on the unit to turn off the unit. ② Press and hold [▶▶/▶▶], [△ OPEN/CLOSE] and [□] on the unit at the same time for more than 5 seconds until “HELLO” is displayed on the unit. ③ The power is turned on and then turned off automatically. | – |

■ Power

| | | |
|---|---|------|
| No power. | <ul style="list-style-type: none"> • Insert the power cable securely into a known active household mains socket. | 4, 5 |
| The unit switches to standby mode. | <ul style="list-style-type: none"> • One of the unit’s safety devices is activated. Press [STANDBY/ON] on the main unit to turn the unit on. | – |

■ Operation

| | | |
|---|--|------|
| The remote control doesn’t work properly. | <ul style="list-style-type: none"> • The batteries are depleted. Replace them with new ones. | 3 |
| | <ul style="list-style-type: none"> • You are not pointing the remote control at the main unit’s remote control signal sensor during operation. | 3 |
| | <ul style="list-style-type: none"> • Coloured glass may obstruct the signal reception/transmission. | – |
| | <ul style="list-style-type: none"> • Don’t place the signal sensor in direct sunlight or in areas that may be subject to sunlight exposure. | – |
| The unit is on but cannot be operated. | <ul style="list-style-type: none"> • Confirm the correct drive is selected. | 9 |
| | <ul style="list-style-type: none"> • Some operations may be prohibited by the disc. | – |
| | <ul style="list-style-type: none"> • The unit is hot (“U59” appears on the display). Wait for “U59” to disappear. | 27 |
| | <ul style="list-style-type: none"> • One of the unit’s safety devices may have been activated. Reset the unit as follows: <ol style="list-style-type: none"> ① Press [STANDBY/ON] on the main unit to switch the unit to standby. If the unit doesn’t switch to standby, press and hold [STANDBY/ON] on the main unit for about 3 seconds. The unit is forcibly switched to standby. Alternatively, disconnect the power cable, wait one minute, then reconnect it. ② Press [STANDBY/ON] on the main unit to switch it on. If the unit still cannot be operated, consult the dealer. | – |
| Play fails to start even when [▶] (PLAY) is pressed. Play starts but then stops immediately. | <ul style="list-style-type: none"> • Insert the disc correctly with the label facing up. | 9 |
| | <ul style="list-style-type: none"> • The disc is dirty. | 27 |
| | <ul style="list-style-type: none"> • You tried to play a blank disc or unplayable disc on this unit. | 2, 3 |
| Cannot eject disc. | <ul style="list-style-type: none"> • The unit may have a problem. While the unit is off, press and hold [□] and [▶▶/▶▶] on the main unit at the same time for about 5 seconds. Remove the disc and consult the dealer. | – |
| Startup is slow. | <ul style="list-style-type: none"> • Startup takes time in the following situations. <ul style="list-style-type: none"> – Immediately after a power failure or the power cable is connected. – When the unit is connected with an HDMI cable. | – |
| When the unit is turned on, audio and video output takes a long time. | | |
| It takes time before play starts. | | |
| Cannot set “On” in “BD-Video 24p Output”. | <ul style="list-style-type: none"> • Only when the unit is connected to the HDMI terminal of a TV supporting 24p can you select “On”. In some cases where the unit is connected to a TV via an amplifier/receiver through the HDMI terminals, you may not be able to select “On”. In this case, connect the unit to a TV through the HDMI terminal and connect it to the amplifier/receiver through any terminal other than HDMI. | 21 |

■ Displays

| | | |
|---|--|----|
| The display is dim. | <ul style="list-style-type: none"> • Change “FL Display” in the Setup menu. | 21 |
| The elapsed time displayed is actually less than the playtime. | <ul style="list-style-type: none"> • The displayed play time is converted from the number of frames at 29.97 frames (equal to 0.999 seconds) to one second. There will be a slight difference between the time displayed and the actual elapsed time (e.g., actual one-hour elapsed time may display as approximately 59 minutes 56 seconds). | – |

| ■ TV screen and video | | Page |
|--|---|---------------|
| The images from this unit do not appear on the television. Picture is distorted. | <ul style="list-style-type: none"> Make sure that the television is connected to the VIDEO OUT terminal, S VIDEO OUT terminal, COMPONENT VIDEO OUT terminals or HDMI AV OUT terminal on this unit. Make sure that the television's input setting (e.g., AV1) is correct. An incorrect resolution is selected in "Component Resolution", when the television is connected to COMPONENT VIDEO OUT terminals. While stopped, press and hold [□] and [▷] (PLAY) on the main unit at the same time for more than 5 seconds to cancel this setting. Set the item again. If "BD-Video 24p Output" is turned "On" when the unit is connected to a TV through any terminal other than HDMI, images may not display properly. In this case, turn "BD-Video 24p Output" to "Off". The unit and television are using different video systems. While stopped, keep pressing [□] and [△ OPEN/CLOSE] on the main unit for 5 or more seconds. The system switches from PAL to NTSC or vice versa. The system used on the disc doesn't match your television. <ul style="list-style-type: none"> PAL discs cannot be correctly viewed on an NTSC television. This unit can convert NTSC signals to PAL60 for viewing on a PAL television ("NTSC Contents Output" in the "Picture"). | 4, 5 |
| | | 21 |
| The screen changes automatically. | <ul style="list-style-type: none"> When the "Screen Saver Function" in the Setup menu is set to "On", the display may return to the screen saver mode automatically if there is no operation for 10 minutes or more. | 21 |
| Video is not output in high definition. | <ul style="list-style-type: none"> High definition video cannot be output through the VIDEO OUT or S VIDEO OUT terminals. Confirm that the "HDMI Video Mode", "HDMI Video Format", and "Component Resolution" in the Setup menu are set properly. The video output resolution is restricted to "576p/480p" when DVD-Video and BD-Video discs recorded at a rate of 50 frames per second is output from the COMPONENT VIDEO OUT terminals. | – |
| | | 21 |
| Status messages do not appear. | <ul style="list-style-type: none"> Select "Automatic" in "On-screen Messages" in the Setup menu. | 21 |
| The 4:3 aspect ratio picture expands left and right. Screen size is wrong. | <ul style="list-style-type: none"> Use the television to change the aspect. Refer to your television's operating instructions. When using a component video cable, set "Progressive" to "Off". If the situation is not restored after that, set "TV Aspect" to "4:3 Pan & Scan". | – 18, 21 |
| There is a lot of after-image when playing video. | <ul style="list-style-type: none"> Turn "3D NR" or "Integrated NR" off if it is on. | 18 |
| When playing DVD-Video using progressive output, one part of the picture momentarily appears to be doubled up. | <ul style="list-style-type: none"> Set "Progressive" of "Picture" menu on the on-screen menu to "Off". This problem is caused by the editing method or material used on DVD-Video, but should be corrected if you use interlace output. When the unit is connected using HDMI terminal, refer to "HDMI connections" (⇒ below). | 18 |
| | | – |
| There is no apparent change in picture quality when adjusted with the "Picture" menu in the on-screen menu. | <ul style="list-style-type: none"> The effect is less perceivable with some types of video. | – |
| The masked-off area is masked in gray. | <ul style="list-style-type: none"> If the "Screen Saver Function" in the Setup menu is set to "Off", the masked-off area is displayed in black. | 21 |
| ■ Sound | | |
| No sound. Low volume. Distorted sound. Cannot hear the desired audio type. | <ul style="list-style-type: none"> Check the connections and the "Digital Audio Output" settings. Check the input mode on the amplifier/receiver if you have connected one. Press [AUDIO] to select the audio. Match the speaker settings with the connected equipment. Change multi channel speaker settings by selecting "Multi Channel" in "Speaker". When "BD-Video Secondary Audio" is set to "Off", Dolby Digital Plus, Dolby TrueHD and DTS-HD are output from the DIGITAL AUDIO OUT terminal as Dolby Digital or DTS Digital Surround bitstream. | 4-6, 20 |
| | | 10 21 |
| Cannot switch audio. | <ul style="list-style-type: none"> There are discs for which audio cannot be changed because of how the disc was created. When connecting an amplifier/receiver using a coaxial cable, optical digital audio cable or an HDMI cable, you cannot switch the audio if "Digital Audio Output" is set to "Bitstream". Set "Digital Audio Output" to "PCM" or connect using audio cables. | – 5, 6, 20 |
| ■ HDMI connections | | |
| The images from this unit do not appear on the television. Picture is distorted. | <ul style="list-style-type: none"> Press [□] and [▷] (PLAY) simultaneously on the unit for more than 5 seconds to shift the mode to one more compatible with HDMI equipment. However, Dolby Digital Plus, Dolby TrueHD, and DTS-HD audio are not output in bitstream. To output the bitstream, select "Default Settings" to restore the factory presets and make proper settings. To output video from a device connected with an HDMI cable, set "HDMI Video Mode" to "On" in the Setup menu. Picture may not be seen when more than 4 devices are connected with HDMI cables. Reduce the number of connected devices. When "BD-Video 24p Output" is set to "On", HDMI authentication takes place where 24 p images switch to other images, and a black screen is displayed. | 19 |
| | | 21 |
| The 4:3 aspect ratio picture expands left and right. Screen size is wrong. | <ul style="list-style-type: none"> Change "TV Aspect" type to "16:9". | – 21 21 |

■ HDMI connections (continued)

Page

| | | |
|---|---|--------------------------|
| When playing DVD-Video using progressive output, one part of the picture momentarily appears to be doubled up. | <ul style="list-style-type: none"> When you use the HDMI AV OUT terminal for video output, follow the steps below for setting. <ol style="list-style-type: none"> Connect this unit to the TV with any cable except the HDMI cable. When you connect with the Component Video cable, set “HDMI Video Mode” to “Off” and “Component Resolution” to “576i/480i” in the Setup menu. | 21 |
| No sound. Low volume. Distorted sound. Cannot hear the desired audio type. | <ul style="list-style-type: none"> Audio may not be heard when more than 4 devices are connected with HDMI cables. Reduce the number of connected devices. To output audio from a device connected with an HDMI cable, set “HDMI Audio Output” to “On” in the Setup menu. If the sound is distorted when the unit is connected to an amplifier/receiver with an HDMI cable, adjust the settings in “Speaker” in the Setup menu to match the connection. Depending on the connected equipment, the sound may be distorted if this unit is connected with an HDMI cable. When “BD-Video Secondary Audio” is set to “On”, Dolby Digital Plus, Dolby TrueHD, and DTS-HD are converted to 48 kHz Dolby Digital and output. LPCM 7.1 channel audio is converted to 5.1 channel audio. In this case, set the “BD-Video Secondary Audio” to “Off”. | – 21 22 – 20 |

■ Card

| | | |
|---|---|--------|
| The capacity of the SD card decreased. | <ul style="list-style-type: none"> When a BD-Video that supports the virtual package is used, and an SD card is in the slot, data may be written to the SD card. Erase the data by using “BD-Video Data Erase”, format the card or use a new card. | 11 |
| MPEG-2 motion pictures and music on an SD card cannot be played. | <ul style="list-style-type: none"> Data that can be played from an SD card are AVCHD and JPEG data. | 3 |
| The contents of the card cannot be read. | <ul style="list-style-type: none"> The card is not compatible or the contents on the card may be damaged. Turn off and then turn on the unit again. | 3 – |

■ Other difficulties with playback

| | | |
|---|---|--------------------|
| Audio and video momentarily pause. | <ul style="list-style-type: none"> This occurs between playlist chapters or scenes (AVCHD). When playing a title recorded on both layers, the unit automatically switches between layers and plays the title in the same way as a normal programme. However, video and audio may momentarily cut out when the unit is switching layers. | – – |
| BD-Video or DVD-Video is not played. | <ul style="list-style-type: none"> Ensure the disc is for the correct BD-Video region code or DVD-Video region number, and is not defective. You have set a ratings level to limit BD-Video or DVD-Video play. Change this setting. Some BD-Video can only be output with HDMI. | i 19 – |
| Picture-in-picture is not played with BD-Video. | <ul style="list-style-type: none"> Confirm whether the disc supports picture-in-picture. | – |
| The virtual package is not played with BD-Video. | <ul style="list-style-type: none"> Confirm whether the disc supports the virtual package. The inserted SD card does not have sufficient available capacity. The SD card is write-protected. Sub contents copied to an SD card are provided by the disc producer as a part of the BD-Video content. Even if you record images and audio onto an SD card, it cannot be played as a virtual package. | 11 – 3 11 |
| Alternative soundtrack and subtitles cannot be selected. | <ul style="list-style-type: none"> The languages are not recorded on the disc. You may not be able to use the on-screen menu to change the soundtrack and subtitles on some discs. Use the disc’s menus to make changes. | – 9, 11 |
| No subtitles. | <ul style="list-style-type: none"> Subtitles are not recorded on the disc. Turn the subtitles on. Set “Subtitle” on the on-screen menu to “On”. | – 17 |
| Angle cannot be changed. | <ul style="list-style-type: none"> Angles can only be changed during scenes where different angles are recorded. | – |
| The resume play function does not work. | <ul style="list-style-type: none"> Memorized positions are canceled when <ul style="list-style-type: none"> pressing [] several times. opening the disc tray. The resume play function may not work depending on the disc. | – – |

MESSAGES

The following messages or service numbers appear on the television or unit's display when something unusual is detected during startup and use.

| ■ On the television | | Page |
|---|---|------------|
| Cannot play. | • You inserted an incompatible disc. | 2, 3 |
| Cannot play on this unit. | • You tried to play a non-compatible image. • Confirm "SD" on the unit's display is not blinking and re-insert the card. | 15 – |
| No disc | • The disc may be upside down. | – |
| ⊗ This operation is currently disabled. | • The operation is prohibited by the unit or disc. | – |
| ■ On the unit's display | | |
| F99 | • The unit fails to operate properly. Press [STANDBY/ON] on the main unit to switch the unit to standby for 3 seconds. Now press [STANDBY/ON] on the main unit again to turn the unit on. | – |
| HDMI ONLY | • Some BD-Video discs can only be output with HDMI. | – |
| No PLAY | • There is a viewing restriction on a BD-Video or DVD-Video. | 19 |
| No READ | • The disc is dirty or badly scratched. The unit cannot play. | – |
| PLEASE WAIT | • Displayed when the unit is started and turned off. This is not a malfunction. • The unit is carrying out its recovery process. You cannot operate the unit while "PLEASE WAIT" is displayed. | – – |
| UNFORMAT | • You inserted an unformatted DVD-RAM, DVD-RW, DVD+RW, an unused DVD+R, DVD+R DL or DVD-RW (DVD-Video format). | – |
| UNSUPPORT | • You have inserted a disc the unit cannot play. | 2, 3 |
| U59 | • The unit is hot. The unit switches to standby for safety reasons. Wait for about 30 minutes until the message disappears. Select a position with good ventilation when installing the unit. Do not block the cooling fan on the rear of the unit. | – |
| U72 U73 | • The HDMI connection acts unusually. – The connected equipment is not HDMI compatible. – Please use HDMI cables that have the HDMI logo (as shown on the cover). – The HDMI cable is damaged. | – |
| H□□ or F□□ | • There is something unusual. (The service number displayed after H and F depends on the unit's condition.) • Check the unit using the troubleshooting guide. If the service number does not disappear, do the following. ① Disconnect the plug from the household mains socket, wait a few seconds, then reconnect it. ② Press [STANDBY/ON] to turn the power on. (The unit may be fixed.) If the service number does not disappear despite doing the above, request service from the dealer. Inform the dealer of the service number when requesting service. | – 24-26 |

DISC AND CARD HANDLING

Clean discs

DO **DO NOT**



Wipe with a damp cloth and then wipe dry.

Disc and card handling precautions

- Handle discs by the edges to avoid inadvertent scratches or fingerprints on the disc.
- Do not attach labels or stickers to discs (This may cause disc warping, rendering it unusable).
- Do not write on the label side with a ball-point pen or other writing instrument.
- Do not use record cleaning sprays, benzene, thinner, static electricity prevention liquids or any other solvent.
- Do not use scratch-proof protectors or covers.
- Clean any dust, water, or foreign matter from the terminals on the rear side of the card.
- Do not use the following discs:
 - Discs with exposed adhesive from removed stickers or labels (rented discs etc).
 - Discs that are badly warped or cracked.
 - Irregularly shaped discs, such as heart shapes.

MAINTENANCE

Clean this unit with a soft, dry cloth

- Never use alcohol, paint thinner or benzene to clean this unit.
- Before using chemically treated cloth, carefully read the instructions that came with the cloth.

Observe the following points to ensure continued listening and viewing pleasure.

Dust and dirt may adhere to the unit's lens over time, making it impossible to play discs.

Do not use any lens cleaners as they may damage the unit.

SPECIFICATIONS

Signal system: PAL/NTSC

Operating temperature range: +5 to +35 °C

Operating humidity range: 10 to 80 % RH (no condensation)

Playable disc:

- BD-ROM: BDMV format (BD-Video format)
- BD-R (Version 2, Single Layer, Dual Layer): BDMV format (BD-Video format)
- BD-RE (Version 3, Single Layer, Dual Layer) : BDMV format (BD-Video format), JPEG*6
- DVD-ROM: DVD-Video format
- DVD-R (Single Layer, Dual Layer)/-RW: DVD-Video format*1, DVD-VR format, AVCHD format*1,7
- DVD+R (Single Layer, Double Layer)/+RW: DVD+VR format, AVCHD format*1,7
- DVD-RAM: DVD-VR format, JPEG*4, AVCHD format*7
- CD: CD-DA
- CD-R/RW: CD-DA, MP3, JPEG*5

SD Card (formatted FAT12, FAT16, FAT32*3): JPEG*4, AVCHD format*7

Video output:

Output level: 1.0 Vp-p (75 Ω)
Output connector: Pin jack (1 system)

S-video output:

Y output level: 1.0 Vp-p (75 Ω)
C output level: 0.286 Vp-p (75 Ω) at Burst
Output connector: S terminal (1 system)

Component video output:

(1080i/720p/480p/480i: 60 Hz)
(1080i/720p/576p/576i: 50Hz)

Y output level: 1.0 Vp-p (75 Ω)
P_b output level: 0.7 Vp-p (75 Ω)
P_r output level: 0.7 Vp-p (75 Ω)
Output connector: Pin jack (Y: green, P_b: blue, P_r: red) (1 system)

Audio output:

Output level: 2 Vrms (1 kHz, 0 dB)
Output connector: Pin jack
Number of connectors: 2 channel: 1 system
5.1 channel discrete output: 1 system

Audio performance:

- Frequency response:
 - DVD (linear audio): 4 Hz to 22 kHz (48 kHz sampling)
 - 4 Hz to 44 kHz (96 kHz sampling)
 - CD-Audio: 4 Hz to 20 kHz
- S/N ratio: 115 dB
- Dynamic range: 100 dB
- Total harmonic distortion: 0.003 %

Digital audio output:

Optical digital output: Optical terminal
Coaxial digital output: Pin jack

HDMI AV output

Output format: 1080p/1080i/720p/576p/480p
Output Connector: Type A (19 pin)
HDMI™ (Deep colour, High Bit rate Audio)
• This unit supports “HDAVI Control 3” functions.

SD card slot:

Output connector: 1 system

Optical pick-up:

Wave length: 782 nm (CDs)/662 nm (DVDs)/405 nm (BDs)

Power supply:

AC 240 V, 50 Hz

Power consumption:

approx. 27 W

Power consumption in standby mode:

less than 1 W

Dimensions (W×D×H)

435 mm × 316 mm × 96 mm

(17 2/16" × 12 7/16" × 3 12/16")

Mass (Weight):

approx. 5.8 kg (12.8 lbs)

Note

- Specifications are subject to change without notice.
- *1 Finalizing is necessary.
- *2 includes SDHC card
 - includes miniSD cards (need a miniSD Adaptor)
 - includes microSD cards (need a microSD Adaptor)
- *3 Does not support long file name
- *4 The total combined maximum number of recognizable picture contents and folders: 3000 picture contents and 300 folders.
- *5 The total combined maximum number of recognizable audio and picture contents and folders: 999 audio and picture contents and 99 folders.
- *6 The total combined maximum number of recognizable picture contents and folders: 9999 picture contents and 300 folders.
- *7 AVCHD format V1.0
- Usable capacity will be less. (SD Card)

| Language code list | | Enter the code with the numbered buttons. | | | | | |
|-----------------------|-------------------|---|----------------------|----------------------|------------------|--|--|
| Abkhazian: 6566 | Catalan: 6765 | Gujarati: 7185 | Lingala: 7678 | Rhaeto-Romance: 8277 | Tamil: 8465 | | |
| Afar: 6565 | Chinese: 9072 | Hausa: 7265 | Lithuanian: 7684 | Romanian: 8279 | Tatar: 8484 | | |
| Afrikaans: 6570 | Corsican: 6779 | Hebrew: 7387 | Macedonian: 7775 | Russian: 8285 | Telugu: 8469 | | |
| Albanian: 8381 | Croatian: 7282 | Hindi: 7273 | Malagasy: 7771 | Samoan: 8377 | Thai: 8472 | | |
| Ameharic: 6577 | Czech: 6783 | Hungarian: 7285 | Malay: 7783 | Sanskrit: 8365 | Tibetan: 6679 | | |
| Arabic: 6582 | Danish: 6865 | Icelandic: 7383 | Malayalam: 7776 | Scots Gaelic: 7168 | Tigrinya: 8473 | | |
| Armenian: 7289 | Dutch: 7876 | Indonesian: 7378 | Maltese: 7784 | Serbian: 8382 | Tonga: 8479 | | |
| Assamese: 6583 | English: 6978 | Interlingua: 7365 | Maori: 7773 | Serbo-Croatian: 8372 | Turkish: 8482 | | |
| Aymara: 6589 | Esperanto: 6979 | Irish: 7165 | Marathi: 7782 | Shona: 8378 | Turkmen: 8475 | | |
| Azerbaijani: 6590 | Estonian: 6984 | Italian: 7384 | Moldavian: 7779 | Sindhi: 8368 | Twi: 8487 | | |
| Bashkir: 6665 | Faroese: 7079 | Japanese: 7465 | Mongolian: 7778 | Singhalese: 8373 | Ukrainian: 8575 | | |
| Basque: 6985 | Fiji: 7074 | Javanese: 7487 | Nauru: 7865 | Slovak: 8375 | Urdu: 8582 | | |
| Bengali; Bangla: 6678 | Finnish: 7073 | Kannada: 7578 | Nepali: 7869 | Slovenian: 8376 | Uzbek: 8590 | | |
| | French: 7082 | Kashmiri: 7583 | Norwegian: 7879 | Somali: 8379 | Vietnamese: 8673 | | |
| Bhutani: 6890 | Frisian: 7089 | Kazakh: 7575 | Oriya: 7982 | Spanish: 6983 | Volapük: 8679 | | |
| Bihari: 6672 | Galician: 7176 | Kirghiz: 7589 | Pashto, Pushto: 8083 | Sundanese: 8385 | Welsh: 6789 | | |
| Breton: 6682 | Georgian: 7565 | Korean: 7579 | Persian: 7065 | Swahili: 8387 | Wolof: 8779 | | |
| Bulgarian: 6671 | German: 6869 | Kurdish: 7585 | Polish: 8076 | Swedish: 8386 | Xhosa: 8872 | | |
| Burmese: 7789 | Greek: 6976 | Laotian: 7679 | Portuguese: 8084 | Tagalog: 8476 | Yiddish: 7473 | | |
| Byelorussian: 6669 | Greenlandic: 7576 | Latin: 7665 | Punjabi: 8065 | Tajik: 8471 | Yoruba: 8979 | | |
| Cambodian: 7577 | Guarani: 7178 | Latvian, Lettish: 7686 | Quechua: 8185 | | Zulu: 9085 | | |

GLOSSARY

■ AVCHD

AVCHD is a new format (standard) for high definition video cameras that can be used to record and play high-resolution HD images.

■ BD-J

Some BD-Video discs contain Java applications, and these applications are called BD-J. You can enjoy various interactive features in addition to playing normal video.

■ Bitstream

This is the digital form of multi-channel audio data (e.g., 5.1 channel) before it is decoded into its various channels.

■ Dolby Digital

This is a method of coding digital signals developed by Dolby Laboratories. Apart from stereo (2-channel) audio, these signals can also be multi-channel audio.

■ Dolby Digital Plus

Multi-channel audio and higher audio quality is made possible using Dolby Digital Plus. BD-Video supports up to 7.1 channel output.

■ Dolby TrueHD

Dolby TrueHD is a very high quality audio format that reproduces the studio master audio. BD-Video supports up to 7.1 channel output.

■ Down-mixing

This is the process of remixing the multi-channel audio found on some discs into fewer channels.

■ DTS (Digital Theater Systems)

This surround system is used in many movie theaters. There is good separation between the channels, so realistic sound effects are possible.

■ DTS-HD

DTS-HD is a high-quality, sophisticated audio format used in movie theaters. Previous DTS Digital Surround-compatible equipment can play DTS-HD as DTS Digital Surround audio. BD-Video supports up to 7.1 channel output.

■ Dynamic range

Dynamic range is the difference between the lowest level of sound that can be heard above the noise of the equipment and the highest level of sound before distortion occurs.

Dynamic range compression means reducing the gap between the loudest and softest sounds. This means you can listen at low volumes but still hear dialog clearly.

■ Film and video

DVD-Video are recorded using either film or video. This unit can determine which type has been used, then uses the most suitable method of progressive output.

Film: Recorded at 25 frames per second (PAL discs) or 24 frames per second (NTSC discs). (NTSC discs recorded at 30 frames per second as well.) Generally appropriate for motion picture films.

Video: Recorded at 25 frames/50 fields per second. (PAL discs) or 30 frames/60 fields per second (NTSC discs). Generally appropriate for TV drama programmes or animation.

■ Final Standard Profile (FSP)

This is a BD-Video [BD-ROM version 2 (Profile 1 version 1.1)] that supports the new functions such as Picture-in-picture, Secondary Audio, and Virtual Package, etc.

■ Frames and fields

Frames refer to the single images that constitute the video you see on your television. Each frame consists of two fields.

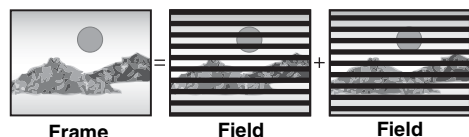

- A frame still shows two fields, so there may be some blurring, but picture quality is generally better.
- A field still shows less picture information so it may be rougher, but there is no blurring.

■ HDMI (High-Definition Multimedia Interface)

HDMI is a digital interface for consumer electronic products. Unlike conventional connections, it transmits uncompressed digital video and audio signals on a single cable.

■ JPEG (Joint Photographic Experts Group)

This is a system used for compressing/decoding colour still pictures. If you select JPEG as the storage system on digital cameras, etc., the data will be compressed to 1/10-1/100 of its original size. The benefit of JPEG is less deterioration in picture quality considering the degree of compression.

■ Local storage

This storage area is used as a destination for sub contents for playing virtual packages on BD-Video.

■ LPCM (Linear PCM)

These are uncompressed digital signals, similar to those found on CDs.

■ MP3 (MPEG Audio Layer 3)

An audio compression method that compresses audio to approximately one tenth of its size without any significant loss of audio quality.

■ Pan&Scan/Letterbox

In general, DVD-Video are produced with the intention that they be viewed on a widescreen television (16:9 aspect ratio), so images often don't fit regular (4:3 aspect ratio) televisions. Two styles of picture, "Pan & Scan" and "Letterbox", deal with this problem.

Pan&Scan: The sides are cut off so the picture fills the screen.



Letterbox: Black bands appear at the top and bottom of the picture so the picture itself appears in an aspect ratio of 16:9.



■ Picture-in-picture

This is a new function of BD-Video that plays the primary video and secondary video simultaneously. For instance, the function is capable of playing the original movie as the primary video while playing video commentary from the film director on a small screen as a secondary video.

■ Progressive/Interlace

The PAL video signal standard has 625 (or 576) interlaced (i) scan lines, whereas progressive scanning, called 625p (or 576p), uses twice the number of scan lines. For the NTSC standard, these are called 525i (or 480i) and 525p (or 480p) respectively. Using progressive output, you can enjoy the high-resolution video recorded on media such as DVD-Video. Your television must be compatible to enjoy progressive video.

■ Sampling frequency

Sampling is the process of converting the heights of sound wave (analog signal) samples taken at set periods into digits (digital encoding). Sampling frequency is the number of samples taken per second, so larger numbers mean more faithful reproduction of the original sound.

■ Virtual package

Some BD-Video discs copy data to other media (local storage) and then play the secondary video, secondary audio, and subtitles (sub contents) simultaneously.

These functions are called virtual packages.

Sub contents are automatically recorded to other media from the disc prior to playing the virtual package. The playback methods vary depending on discs.

■ 1080i (1125i)

In one high definition image, 1080 (1125) alternating scan lines pass to create an interlaced image. Because 1080i (1125i) more than doubles current television broadcasts of 480i, the detail is much clearer and creates a more realistic and rich image.

■ 1080p (1125p)

In one high definition image, 1080 (1125) scan lines pass at the same time to create a progressive image. Since progressive video does not alternate scan lines like interlace, there is a minimal amount of screen flicker.

■ 24p

This is a progressive image recorded at a rate of 24 frames per second.

■ 720p (750p)

In one high definition image, 720 (750) scan lines pass at the same time to create a progressive image. Since progressive video does not alternate scan lines like interlace, there is a minimal amount of screen flicker.

INDEX

| | | |
|---|---|---|
| <p>■ A</p> <p>Angle 17</p> <p>Audio</p> <p> Attribute 17</p> <p> Changing audio 10</p> <p> Channel 17</p> <p>AVCHD 29</p> <p>■ B</p> <p>BD-J 29</p> <p>BD-Video Ratings 19</p> <p>■ C</p> <p>Chapter 12</p> <p>Cleaning</p> <p> Disc 27</p> <p> Main unit 27</p> <p>Connection</p> <p> Amplifier/receiver 5, 6</p> <p>■ D</p> <p>Default Settings 19</p> <p>Dialog Enhancer 18</p> <p>DIRECT NAVIGATOR 9, 12</p> <p>Dolby Digital 17, 20</p> <p>Dolby Digital Plus 17, 20</p> <p>Dolby TrueHD 17, 20</p> <p>DTS 17, 20</p> <p>DTS-HD 17, 20</p> <p>■ F</p> <p>Final Standard Profile 11, 29</p> <p>Finalize 2</p> <p>Format 11</p> | <p>■ H</p> <p>HDMI 4, 5</p> <p>■ J</p> <p>JPEG 12, 15, 29</p> <p>■ L</p> <p>Language</p> <p> Code list 28</p> <p> Local storage 29</p> <p> LPCM 29</p> <p> Soundtrack 17</p> <p> Subtitle 17, 19</p> <p>■ M</p> <p>Maintenance 27</p> <p>Menu</p> <p> MP3 14, 15</p> <p> On-screen 17</p> <p> Pop-up 11</p> <p> Setup 19</p> <p>■ N</p> <p>Noise reduction (NR)</p> <p> Integrated NR 18</p> <p> 3D NR 18</p> <p>■ O</p> <p>On-screen</p> <p> Menu 17</p> <p> Status messages 10</p> | <p>■ P</p> <p>PCM Down Conversion 20</p> <p>Picture-in-picture 11</p> <p>Pop-up Menu 11</p> <p>Progressive 18, 29</p> <p>Properties</p> <p> Chapter 12</p> <p> Still picture 13</p> <p>■ R</p> <p>Ratings level 19</p> <p>Repeat play 18</p> <p>Resume play function 10</p> <p>■ S</p> <p>SD card 3, 12</p> <p>Setup menu 19</p> <p>Slideshow 13</p> <p>Soundtrack 17</p> <p>Status messages 10</p> <p>Still pictures 13</p> <p>Subtitle 17</p> <p>■ T</p> <p>Transfer 18</p> <p>■ V</p> <p>Virtual package 11</p> <p>24P 21, 29</p> |
|---|---|---|

| |
|---|
| Java and all Java-based trademarks and logos are trademarks or registered trademarks of Sun Microsystems, Inc. in the United States and other countries. |
| Manufactured under license from Dolby Laboratories. Dolby and the double-D symbol are trademarks of Dolby Laboratories. |
| Manufactured under license under U.S. Patent No's: 5,451,942; 5,956,674; 5,974,380; 5,978,762; 6,487,535 and other U.S. and worldwide patents issued and pending. DTS is a registered trademark and the DTS logos, Symbol, DTS-HD and DTS-HD Advanced Digital Out are trademarks of DTS, Inc. Copyright 1996-2007 DTS, Inc. All Rights Reserved. |
| U.S. Patent Nos. 6,836,549; 6,381,747; 7,050,698; 6,516,132; and 5,583,936. |
| This product incorporates copyright protection technology that is protected by U.S. patents and other intellectual property rights. Use of this copyright protection technology must be authorized by Macrovision, and is intended for home and other limited viewing uses only unless otherwise authorized by Macrovision. Reverse engineering or disassembly is prohibited. |
| HDMI, the HDMI logo and High-Definition Multimedia Interface are trademarks or registered trademarks of HDMI Licensing LLC. |
| This product is licensed under the AVC patent portfolio license and VC-1 patent portfolio license for the personal and non-commercial use of a consumer to (i) encode video in compliance with the AVC Standard and VC-1 Standard ("AVC/VC-1 Video") and/or (ii) decode AVC/VC-1 Video that was encoded by a consumer engaged in a personal and non-commercial activity and/or was obtained from a video provider licensed to provide AVC/VC-1 Video. No license is granted or shall be implied for any other use. Additional information may be obtained from MPEG LA, LLC. See http://www.mpegla.com . |
| HDAVI Control™ is a trademark of Matsushita Electric Industrial Co., Ltd. |
| "AVCHD" and the "AVCHD" logo are trademarks of Matsushita Electric Industrial Co., Ltd. and Sony Corporation. |
| SDHC Logo is a trademark. |
| Portions of this product are protected under copyright law and are provided under license by ARIS/SOLANA/4C. |
| "BONUSVIEW" is a trademark of Blu-ray Disc Association. |

