



PORTATONE
PSR-550

Owner's Manual

SPECIAL MESSAGE SECTION

This product utilizes batteries or an external power supply (adapter). DO NOT connect this product to any power supply or adapter other than one described in the manual, on the name plate, or specifically recommended by Yamaha.

This product should be used only with the components supplied or; a cart, rack, or stand that is recommended by Yamaha. If a cart, etc., is used, please observe all safety markings and instructions that accompany the accessory product.

SPECIFICATIONS SUBJECT TO CHANGE:

The information contained in this manual is believed to be correct at the time of printing. However, Yamaha reserves the right to change or modify any of the specifications without notice or obligation to update existing units.

This product, either alone or in combination with an amplifier and headphones or speaker/s, may be capable of producing sound levels that could cause permanent hearing loss. DO NOT operate for long periods of time at a high volume level or at a level that is uncomfortable. If you experience any hearing loss or ringing in the ears, you should consult an audiologist.

IMPORTANT: The louder the sound, the shorter the time period before damage occurs.

NOTICE:

Service charges incurred due to a lack of knowledge relating to how a function or effect works (when the unit is operating as designed) are not covered by the manufacturer's warranty, and are therefore the owners responsibility. Please study this manual carefully and consult your dealer before requesting service.

ENVIRONMENTAL ISSUES:

Yamaha strives to produce products that are both user safe and environmentally friendly. We sincerely believe that our products and the production methods used to produce them, meet these goals. In keeping with both the letter and the spirit of the law, we want you to be aware of the following:

Battery Notice:

This product MAY contain a small non-rechargeable battery which (if applicable) is soldered in place. The average life span of this type of battery is approximately five years.

When replacement becomes necessary, contact a qualified service representative to perform the replacement.

This product may also use "household" type batteries. Some of these may be rechargeable. Make sure that the battery being charged is a rechargeable type and that the charger is intended for the battery being charged.

When installing batteries, do not mix batteries with new, or with batteries of a different type. Batteries MUST be installed correctly. Mismatches or incorrect installation may result in overheating and battery case rupture.

Warning:

Do not attempt to disassemble, or incinerate any battery. Keep all batteries away from children. Dispose of used batteries promptly and as regulated by the laws in your area. Note: Check with any retailer of household type batteries in your area for battery disposal information.

Disposal Notice:

Should this product become damaged beyond repair, or for some reason its useful life is considered to be at an end, please observe all local, state, and federal regulations that relate to the disposal of products that contain lead, batteries, plastics, etc. If your dealer is unable to assist you, please contact Yamaha directly.

NAME PLATE LOCATION:

The name plate is located on the bottom of the product. The model number, serial number, power requirements, etc., are located on this plate. You should record the model number, serial number, and the date of purchase in the spaces provided below and retain this manual as a permanent record of your purchase.

Model

Serial No.

Purchase Date

PLEASE KEEP THIS MANUAL

PRECAUTIONS

PLEASE READ CAREFULLY BEFORE PROCEEDING

* Please keep these precautions in a safe place for future reference.



WARNING

Always follow the basic precautions listed below to avoid the possibility of serious injury or even death from electrical shock, short-circuiting, damages, fire or other hazards. These precautions include, but are not limited to, the following:

- Do not open the instrument or attempt to disassemble the internal parts or modify them in any way. The instrument contains no user-serviceable parts. If it should appear to be malfunctioning, discontinue use immediately and have it inspected by qualified Yamaha service personnel.
- Do not expose the instrument to rain, use it near water or in damp or wet conditions, or place containers on it containing liquids which might spill into any openings.
- If the AC adaptor cord or plug becomes frayed or damaged, or if there is a sudden loss of sound during use of the instrument, or if any unusual smells or smoke should appear to be caused by it, immediately turn off the power switch, disconnect the adaptor plug from the outlet, and have the instrument inspected by qualified Yamaha service personnel.
- Use the specified adaptor (PA-6 or an equivalent recommended by Yamaha) only. Using the wrong adaptor can result in damage to the instrument or overheating.
- Before cleaning the instrument, always remove the electric plug from the outlet. Never insert or remove an electric plug with wet hands.
- Check the electric plug periodically and remove any dirt or dust which may have accumulated on it.



CAUTION

Always follow the basic precautions listed below to avoid the possibility of physical injury to you or others, or damage to the instrument or other property. These precautions include, but are not limited to, the following:

- Do not place the AC adaptor cord near heat sources such as heaters or radiators, and do not excessively bend or otherwise damage the cord, place heavy objects on it, or place it in a position where anyone could walk on, trip over, or roll anything over it.
- When removing the electric plug from the instrument or an outlet, always hold the plug itself and not the cord.
- Do not connect the instrument to an electrical outlet using a multiple-connector. Doing so can result in lower sound quality, or possibly cause overheating in the outlet.
- Unplug the AC power adaptor when not using the instrument, or during electrical storms.
- Always make sure all batteries are inserted in conformity with the +/- polarity markings. Failure to do so might result in overheating, fire, or battery fluid leakage.
- Always replace all batteries at the same time. Do not use new batteries together with old ones. Also, do not mix battery types, such as alkaline batteries with manganese batteries, or batteries from different makers, or different types of batteries from the same maker, since this can cause overheating, fire, or battery fluid leakage.
- Do not dispose of batteries in fire.
- Do not attempt to recharge batteries that are not intended to be charged.
- When the batteries run out, or if the instrument is not to be used for a long time, remove the batteries from the instrument to prevent possible leakage of the battery fluid.
- Keep batteries away from children.
- If the batteries do leak, avoid contact with the leaked fluid. If the battery fluid should come in contact with your eyes, mouth, or skin, wash immediately with water and consult a doctor. Battery fluid is corrosive and may possibly cause loss of sight or chemical burns.
- Before connecting the instrument to other electronic components, turn off the power for all components. Before turning the power on or off for all components, set all volume levels to minimum. Also, be sure to set the volumes of all components at their minimum levels and gradually raise the volume controls while playing the instrument to set the desired listening level.
- Do not expose the instrument to excessive dust or vibrations, or extreme cold or heat (such as in direct sunlight, near a heater, or in a car during the day) to prevent the possibility of panel disfiguration or damage to the internal components.
- Do not use the instrument near other electrical products such as televisions, radios, or speakers, since this might cause interference which can affect proper operation of the other products.
- Do not place the instrument in an unstable position where it might accidentally fall over.
- Before moving the instrument, remove all connected adaptor and other cables.
- When cleaning the instrument, use a soft, dry cloth. Do not use paint thinners, solvents, cleaning fluids, or chemical-impregnated wiping cloths. Also, do not place vinyl, plastic or rubber objects on the instrument, since this might discolor the panel or keyboard.
- Do not rest your weight on, or place heavy objects on the instrument, and do not use excessive force on the buttons, switches or connectors.
- Use only the stand specified for the instrument. When attaching the stand or rack, use the provided screws only. Failure to do so could cause damage to the internal components or result in the instrument falling over.
- Do not operate the instrument for a long period of time at a high or uncomfortable volume level, since this can cause permanent hearing loss. If you experience any hearing loss or ringing in the ears, consult a physician.

■ DATA BACK-UP AND STORAGE

- Yamaha recommends that you regularly save data using a floppy disk in a safe, cool, dry place. **YAMAHA CANNOT BE HELD RESPONSIBLE FOR THE ACCIDENTAL LOSS OF IMPORTANT MUSIC DATA!** Regarding the data you have created, as long as fresh batteries are inserted in (or an AC power adaptor is connected to) the instrument, the data will be retained, even when the power is turned off. It will also be retained long enough to exchange an old set of batteries for a new set. If you have important data in the instrument which you don't want to lose, please take care to keep fresh batteries inserted in (or keep an AC power adaptor connected to) the instrument, and to regularly save data.

Yamaha cannot be held responsible for damage caused by improper use or modifications to the instrument, or data that is lost or destroyed.

Always turn the power off when the instrument is not in use.

Make sure to discard used batteries according to local regulations.

Congratulations!

You are the proud owner of a fine electronic keyboard. The Yamaha PSR-550 PortaTone combines the most advanced tone generation technology with state-of-the-art digital electronics and features to give you stunning sound quality with maximum musical enjoyment. A large graphic display and easy-to-use interface also greatly enhance the operability of this advanced instrument. In order to make the most of your PortaTone's features and extensive performance potential, we urge you to read the manual thoroughly while trying out the various features described. Keep the manual in a safe place for later reference.

Packing List

Please check that these items have been packed with your PSR-550.

- PSR-550

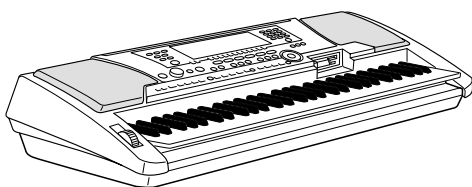

- Music Stand (page 9)

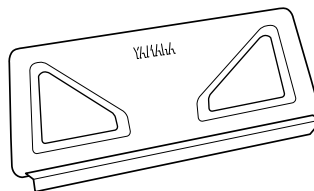

- PSR-550 Data Disk

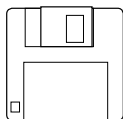

(Refer to "Included Data Disk" on page 59, and "MIDI and TO HOST Terminals" on page 107.)

- Owner's Manual

How to use the manual

Setting Up

page 12

Before going on to any other part of the manual, we strongly suggest you read this section first. It shows you how to get started playing and using your new PSR-550.

Important Features

page 8

Once you've set up the PSR-550, you should read through this section — and explore the relevant page references — to familiarize yourself with the enormous variety of features and functions of the PSR-550.

Basic Operation

page 17

This section introduces you to the basic operating conventions of the PSR-550, such as editing values and changing settings, and shows you how to use the convenient Help and Direct Access functions.

Contents

page 6

All topics, features, functions and operations are listed here in the order they appear in the manual, for easy reference.

Panel Controls

page 10

Use this section to find out about all of the buttons and controls of the PSR-550.

Panel Display Indications

page 16

This section explains the display indications of the PSR-550 and how to read them for optimum operation.

Function Tree

page 22

This lists all functions of the PSR-550 according to their hierarchical structure, letting you easily see the relationship of the various functions and quickly locate desired information.

Appendix

page 123

This contains various important lists such as the Voice list, Preset Style list, Effect list, MIDI data format and MIDI implementation chart.

Troubleshooting

page 135

If the PSR-550 does not function as expected or you have some problem with the sound or operation, consult this section before calling your Yamaha dealer or service center. Most common problems and their solutions are covered here in a very simple and easy-to-understand way.

Index

page 153

This section alphabetically lists virtually all topics, features, functions and operations with their respective page numbers, letting you quickly and easily find the information you need.

The illustrations and LCD screens as shown in this owner's manual are for instructional purposes only, and may be different from your instrument.

Contents

Packing List	4	Playing Voices	26
How to use the manual	5	Selecting a Voice	26
Important Features	8	Playing Two Voices (R1, R2) Simultaneously	27
Panel logos	9	Playing Different Voices with the Left (L) and Right (R1, R2) Hands	28
Music stand	10	Functions of the Keyboard	29
Panel Controls and Terminals	10	Transpose	30
FOOTSWITCH jack	10	Pitch Bend Wheel	30
PHONES/OUTPUT jack	10	Sustain	30
Top Panel Controls	11	Keyboard Percussion	31
Rear Panel Controls	11	Auto Accompaniment	32
Setting Up	12	Using Auto Accompaniment (rhythm track only)	32
Power supply connections	12	Using Auto Accompaniment (all tracks)	33
Demo Song Playback	13	Accompaniment Sections	34
Using the Music Database	14	Tempo/Tap	36
Panel Display Indications	16	Accompaniment Track Muting	37
Basic Operation	17	Accompaniment Volume Control	37
Calling up the Operation Displays	17	Chord Fingerings	38
How to Read the Menu/Message Display and “Easy Navigator”	18	Accompaniment Split Point	40
Menu Selection	19	Synchro Stop	41
Changing (Editing) Values	20	One Touch Setting	42
Naming	21	The Multi Pads	43
Direct Access	21	Playing the Multi Pads	43
Function Tree	22	Chord Match	43
Direct Access Chart	24	Selecting a Multi Pad Bank	44
Mode	25	Turning Chord Match On/Off	44
Style Mode	25	Multi Pad Bank List	45
Song Mode	25	Digital Effects	46
Record Mode	25	Reverb	46
Disk Mode	25	Chorus	48
Playing Voices	26	DSP	49
Selecting a Voice	26	System Effects and Insertion Effects	50
Playing Two Voices (R1, R2) Simultaneously	27	Harmony/Echo	50
Playing Different Voices with the Left (L) and Right (R1, R2) Hands	28	Registration Memory	54
Functions of the Keyboard	29	Registering the Panel Settings	55
Transpose	30	Recalling the Registered Panel Settings	55
Pitch Bend Wheel	30	Selecting a Registration Bank	56
Sustain	30	Naming the Registration Banks	56
Keyboard Percussion	31	Disk Operations	57
Auto Accompaniment	32	Using the Floppy Disk Drive (FDD) and Floppy Disks	58
Using Auto Accompaniment (rhythm track only)	32	Included Data Disk	59
Using Auto Accompaniment (all tracks)	33	Format	60
Accompaniment Sections	34	Save	60
Tempo/Tap	36	Load	62
Accompaniment Track Muting	37	Song Copy	64
Accompaniment Volume Control	37	Delete	67
Chord Fingerings	38		
Accompaniment Split Point	40		
Synchro Stop	41		
One Touch Setting	42		
The Multi Pads	43		
Playing the Multi Pads	43		
Chord Match	43		
Selecting a Multi Pad Bank	44		
Turning Chord Match On/Off	44		
Multi Pad Bank List	45		
Digital Effects	46		
Reverb	46		
Chorus	48		
DSP	49		
System Effects and Insertion Effects	50		
Harmony/Echo	50		
Registration Memory	54		
Registering the Panel Settings	55		
Recalling the Registered Panel Settings	55		
Selecting a Registration Bank	56		
Naming the Registration Banks	56		
Disk Operations	57		
Using the Floppy Disk Drive (FDD) and Floppy Disks	58		
Included Data Disk	59		
Format	60		
Save	60		
Load	62		
Song Copy	64		
Delete	67		

Disk Song Playback 68

Song Playback	68
Song Track Muting	70
Song Volume Control	70
Playing from a Specified Measure	71
Repeat Play (A-B Repeat)	72
Song Transpose	73

Part Settings 74

Voice Change	75
Mixer	76

Song Recording 78

Quick Recording	80
Multi Track Recording	82
Re-recording — Punch In/Out and Start Measure ..	84
Quantize	86
Editing Setup Data	88
Naming User Songs	90
Clearing User Song Data	91

Multi Pad Recording 92

Multi Pad Recording	92
Chord Match	94
Naming User Pads	94
Clearing User Pad Data	95

Style Recording 96

Style Recording — Rhythm Track	98
Style Recording — Bass/Phrase/Pad/Chord Tracks	100
Quantize	102
Naming User Styles	104
Clearing User Style Data	104

MIDI Functions 106

What's MIDI?	106
What You Can Do With MIDI	108
MIDI Data Compatibility	109
Connecting to a Personal Computer	110
MIDI Template	112
MIDI Transmit Setting	114
MIDI Receive Setting	115
Local Control	116
Clock	116
Initial Data Send	117

Other Functions (Utility) 118

Metronome	118
Upper Octave	119
Master Tuning	119
Scale Tuning	119
Split Point	120
Touch Sensitivity	120
Voice Set	120
Footswitch	121
Pitch Bend Range	122
Assignable	122
Backlight	122

Appendix 123

Voice List	123
Panel Voice List	123
XG Voice List	125
Drum Kit List	128
Style List	130
Music Database List	131
About the Digital Effects (Reverb/Chorus/DSP) ...	132
Reverb Type List	133
Chorus Type List	133
DSP Type List	133
Harmony/Echo Type List	134
Troubleshooting	135
Data Backup & Initialization	136
Alert Message List	137
MIDI Data Format	139
MIDI Implementation Chart	151
Index	153
Specifications	156

Important Features

Since the PSR-550 has such a wealth of advanced features and functions, you may be at a loss as to how to explore its capabilities and how to best use them for your music. You needn't worry. The PSR-550 is very easy to play and use, and each function — no matter how advanced — can be mastered easily.

That's what this section is designed for. It will help you master the PSR-550. It introduces you to the important features of the PSR-550 with short explanations and page references. Read through the features you're interested in, then turn to the relevant pages in the manual for instructions and other details.

Basic operations



- The PSR-550 is packed with sophisticated feature and functions, yet it's also exceptionally easy to use. Using the panel controls is quick, easy and intuitive — thanks to the Easy navigator feature, which indicates the buttons you should press, and the special backlit LCD, which changes color according to the selected mode. (→ Pages 16, 18)
- A convenient Direct Access function lets you instantly call up the specific menu or display you need. (→ Page 21)

Listening to the PSR-550



- The PSR-550 features a wide variety of songs in various musical genres. (→ Page 15)
- In addition, 10 songs are provided in the included disk. (→ Page 59)
- The powerful auto accompaniment function gives you a total of 112 styles (rhythm and accompaniment patterns), providing professional sounding backing parts for your performance. (→ Page 112)
- Special Multi Pads let you instantly and easily play short rhythmic and melodic sequences for adding impact and variety to your performance. (→ Page 43)

Playing the PSR-550

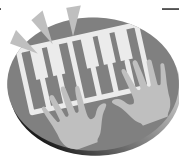

- The PSR-550 keyboard has 61 keys with full touch-response capability that lets you play with extraordinary expressiveness and dynamic control. (→ Page 26)
- The PSR-550 lets you perform with a huge variety of musical instrument voices. (→ Page 26) There are two different types of voices: panel voices (the original PSR-550voices) and XG voices.
 - * The PSR-550 features 219 panel voices, 14 drum kits and 480 XG voices
- With the R1, R2 and L voices, you can play two different voices in a layer, and even play two different voices with your right and left hands. (→ Pages 27, 28)

Auto accompaniment (styles)

- The auto accompaniment feature puts a full backing band at your fingertips, with a total of 112 styles (rhythm and accompaniment patterns). (→ Page 32)
- The One Touch Setting feature lets you instantly call up the appropriate voice, effect and other settings for the selected accompaniment style — with the touch of a single button. (→ Page 42)
- You can also create your original accompaniment styles by recording them directly from the keyboard. (→ Page 96)

Music Database

- The PSR-550's built-in Music Database gives you a convenient way to automatically select the style, voice, and effect settings that best suit a particular type of music. If you don't know which style or voice would be appropriate, the Music Database can help you out. (→ Page 14)

Multi Pads

- By simply pressing one of the Multi Pads, you can play short rhythmic or melodic phrases. (→ Page 43)
- You can also create your original Multi Pad phrases by recording them directly from the keyboard. (→ Page 92)

Registration Memory

- The convenient Registration Memory feature lets you save virtually all panel settings to one of 128 Registration Memory settings, and then instantly recall all your custom panel settings by pressing a single button. (→ Page 54)

Song Recording

- Use the powerful song recording features create your own complete, fully orchestrated compositions and save them floppy disk as a User song. Each User song lets you record up to sixteen independent tracks. (→ Page 78)
 - * To quickly and easily mold your musical ideas into complete songs, use the Quick Recording method. (→ Page 80)
 - * To build up a song part-by-part and track-by-track, use the Multi Track Recording method. (→ Page 82)
 - * You can also "fine tune" the recorded song data with the PSR-550's comprehensive song editing functions. (→ Pages 84-91)

Digital Effects

- A comprehensive set of professional-sounding digital effects are built into the PSR-550, letting you enhance the sound of your performance in a wide variety of ways. These include Reverb, Chorus, DSP and Harmony/Echo. (→ Page 46)
 - * Reverb recreates the rich spacial ambiance of various performance environments, such as a concert hall or a night club. (→ Page 46)
 - * Chorus enriches the voices by making them sound warmer and thicker — as if several instruments were playing together at the same time. (→ Page 48)
 - * The DSP effects let you process the sound in special, unusual ways — such as applying distortion or tremolo to a specific part. (→ Page 49)
 - * Harmony/Echo lets you enhance your right-hand melodies with a variety of harmony and echo effects. (→ Page 50)

Disk Drive

- The PSR-550 also features a built-in disk drive that lets you save all your important original data (such as User songs, User styles, User Multi Pads, Registration Memory, etc.) to floppy disk for future recall. (→ Page 57)

MIDI

- MIDI (Musical Instrument Digital Interface) is a worldwide standard interface that allows various electronic music instruments, computers and other devices to communicate with each other. The MIDI features let you seamlessly integrate the PSR-550 into a variety of systems and applications:
 - * Play other instruments from the PSR-550. (→ Page 108)
 - * Play the sounds of the PSR-550 (including the auto accompaniment) from a connected keyboard. (→ Page 108)
 - * Connect the PSR-550 directly to a computer, for advanced recording, editing and playing back of song data. (→ Page 110)
 - * Use pre-programmed templates to instantly configure the PSR-550 for your specific MIDI system/application. (→ Page 112)

Panel logos

The logos printed on the PSR-550 panel indicate standards/formats it supports and special features it includes.



GM System Level 1

“GM System Level 1” is an addition to the MIDI standard which guarantees that any data conforming to the standard will play accurately on any GM-compatible tone generator or synthesizer from any manufacturer.



XG is a new Yamaha MIDI specification which significantly expands and improves on the GM System Level 1 standard with greater voice handling capacity, expressive control and effect capability while retaining full compatibility with GM. By using the PSR-550's XG voices, it is possible to record XG-compatible song files.



The DOC voice allocation format provides data playback compatibility with a wide range of Yamaha instruments and MIDI devices, including the Clavinova series.



Style File Format

The Style File Format — SFF — is Yamaha's original style file format which uses a unique conversion system to provide high-quality automatic accompaniment based on a wide range of chord types. The PSR-550 uses the SFF internally, reads optional SFF style disks, and creates SFF styles using the Style Recording feature.

Music stand

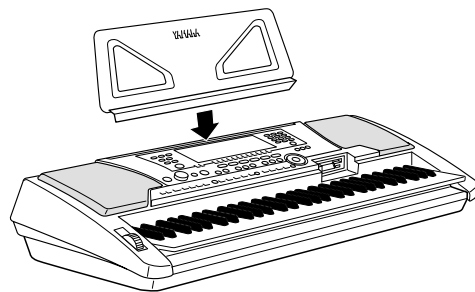

The PSR-550 is supplied with a music stand that can be attached to the instrument by inserting it into the slot at the rear of the control panel.

Panel Controls and Terminals

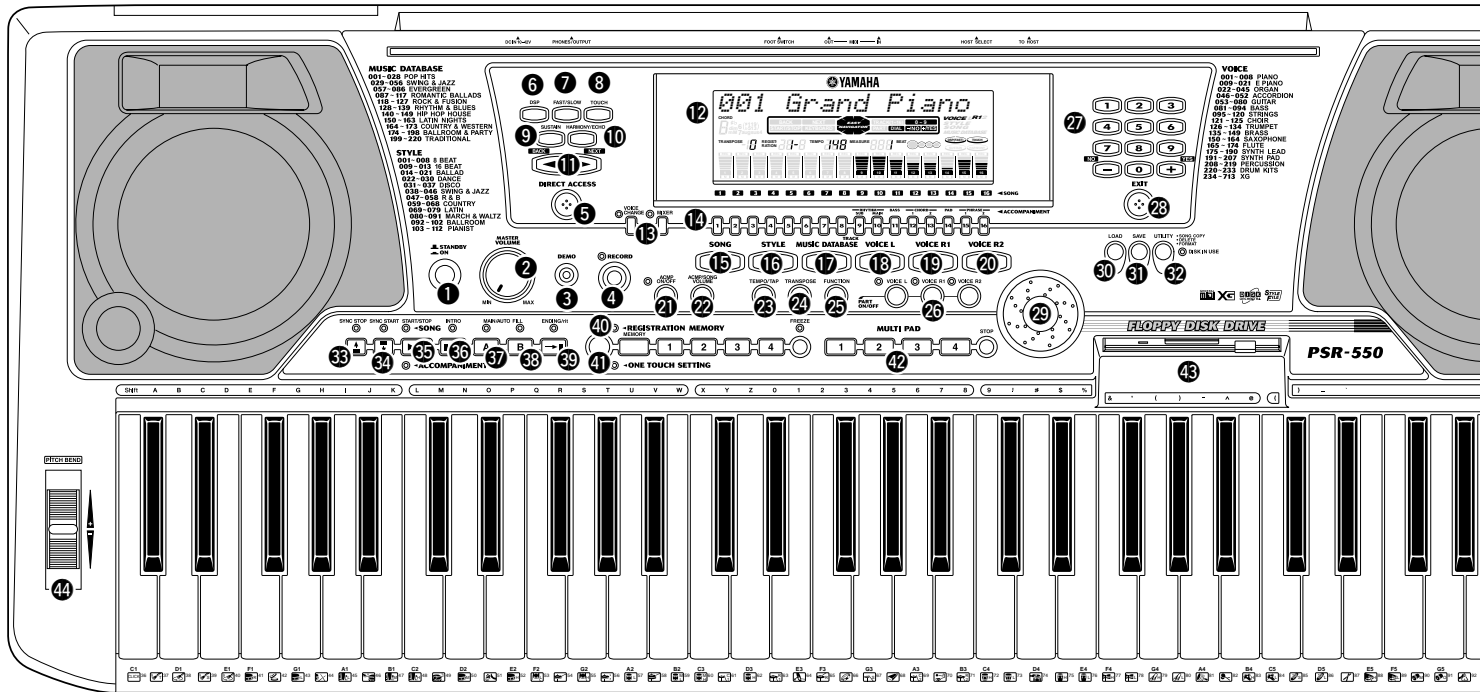

■ FOOTSWITCH jack

The sustain function lets you produce a natural sustain as you play by pressing a footswitch. Plug an optional Yamaha FC4 or FC5 footswitch into this jack and use it to switch sustain on and off. The footswitch connected to this jack can also be set to replicate the functions of some panel buttons, doing things like starting and stopping accompaniment (page 121).

NOTE

- Be sure that you do not press the footswitch while turning the power on. If you do, the ON/OFF status of the footswitch will be reversed.
- When the sustain or sostenuto pedal functions are being used (page 121), some voices may sound continuously or have a long decay after the notes have been released while the pedal is held.

■ PHONES/OUTPUT jack

A standard pair of stereo headphones can be plugged in here for private practice or late-night playing. The internal stereo speaker system is automatically shut off when a pair of head phones is plugged into the PHONES/OUTPUT jack. Do not listen with the headphones at high volume for long periods of time. Doing so may cause hearing loss.

⚠ CAUTION

- Connect the PSR-550 to external equipment only after turning off power for all devices. To prevent damage to the speakers, set the volume of the external devices at the minimum setting before connecting them. Failure to observe these cautions may result in electric shock or equipment damage.

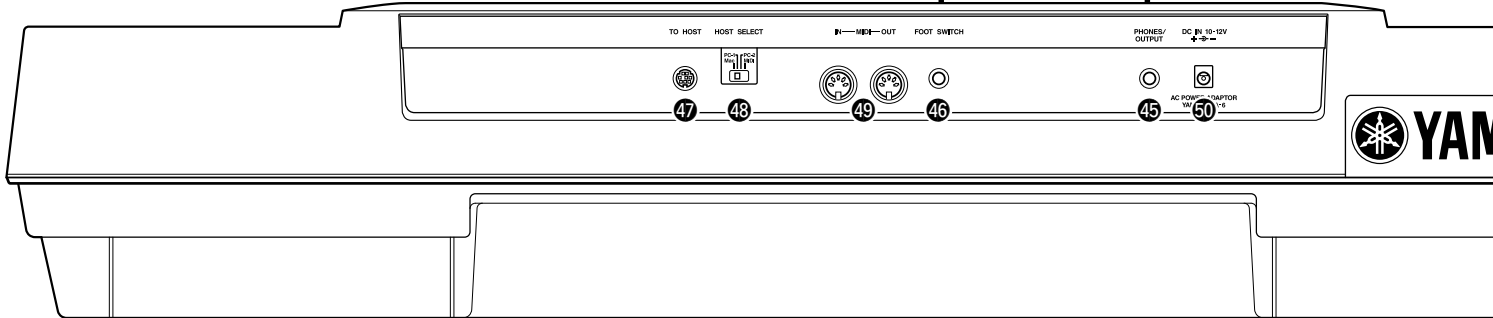

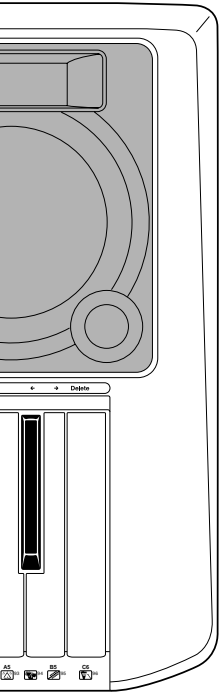

Top Panel Controls

1	STANDBY/ON switch	13
2	MASTER VOLUME control	13
3	DEMO button	13, 17
4	RECORD button	17, 25, 78, 92, 96
5	DIRECT ACCESS button	21, 24
6	DSP button	49
7	FAST/SLOW button	49
8	TOUCH button	120
9	SUSTAIN button	30
10	HARMONY/ECHO button	50
11	BACK button, NEXT button	17
12	LCD display	16
13	VOICE CHANGE button	17, 75
	MIXER button	17, 76
14	TRACK 1 - 16 buttons	37, 70
15	SONG button	17, 25, 68
16	STYLE button	17, 25, 32
17	MUSIC DATABASE button	14, 17
18	VOICE L button	17, 28
19	VOICE R1 button	17, 26
20	VOICE R2 button	17, 27
21	ACMP ON/OFF button	25, 33
22	ACMP/SONG VOLUME button	17, 37, 70

23	TEMPO/TAP button	17, 36
24	TRANPOSE button	17, 30
25	FUNCTION button	17, 118
26	PART ON/OFF	
	VOICE L button	28
	VOICE R1 button	26
	VOICE R2 button	27
27	Number buttons	
	[1]-[0], [-/NO], [+ /YES]	20
28	EXIT button	17
29	Data dial	20
30	DISK LOAD button	17, 62
31	DISK SAVE button	17, 60
32	DISK UTILITY button	17, 64, 67
33	SYNC STOP button	41
34	SYNC START button	33
35	START/STOP button	32, 69
36	INTRO button	34
37	MAIN/AUTO FILL A button	34
38	MAIN/AUTO FILL B button	34
39	ENDING/rit. button	34
40	REGISTRATION MEMORY buttons	54
41	ONE TOUCH SETTING buttons	42
42	MULTI PAD buttons	43
43	Disk Drive	58
44	PITCH BEND wheel	30

Rear Panel Controls

45	PHONES/OUTPUT jack	10
46	FOOTSWITCH jack	10
47	TO HOST connector	107
48	HOST SELECT switch	110
49	MIDI IN/OUT connectors	107
50	DC IN 10-12V jack	12

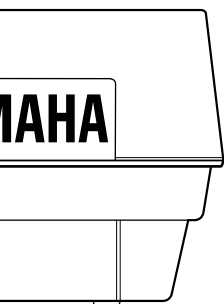

Setting Up

This section contains information about setting up your PSR-550 and preparing to play. Be sure to go through this section carefully before turning the power on.

Power supply connections

Although the PSR-550 will run either from an optional AC adaptor or batteries, Yamaha recommends use of the more environmentally safe AC adaptor. Follow the instructions below according to the power source you intend to use.

■ Using An Optional AC Power Adaptor

- 1 Make sure that the STANDBY/ON switch of the PSR-550 is set to STANDBY.
- 2 Connect the AC adaptor (PA-6 or other adaptor specifically recommended by Yamaha) to the power supply jack.
- 3 Plug the AC adaptor into an AC outlet.

When turning the power OFF, simply reverse the procedure.

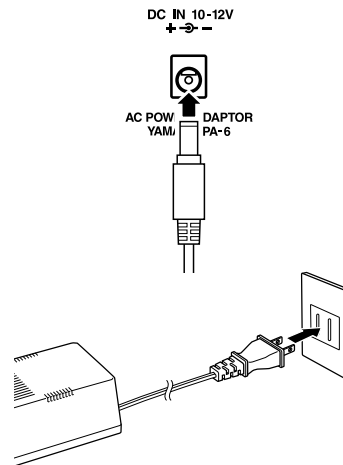

⚠ CAUTION

- Never interrupt the power supply (e.g. remove the batteries or unplug the AC adaptor) during any PSR-550 record operation! Doing so can result in a loss of data.

⚠ WARNING

- Use ONLY a Yamaha PA-6 AC Power Adaptor (or other adaptor specifically recommended by Yamaha) to power your instrument from the AC mains. The use of other adaptors may result in irreparable damage to both the adaptor and the PSR-550.
- Unplug the AC Power Adaptor when not using the PSR-550, or during electrical storms.

■ Using Batteries

For battery operation the PSR-550 requires six 1.5V “D” size, R20P (LR20) or equivalent batteries. When the batteries need to be replaced, “Battery Low” may appear on top of the display, the volume may be reduced, the sound may be distorted, and other problems may occur. When this happens, turn the power off and replace the batteries.

Replace the batteries as follows:

- 1 Open the battery compartment cover located on the instrument’s bottom panel.
- 2 Insert the six new batteries, being careful to follow the polarity markings on the inside of the compartment.
- 3 Replace the compartment cover, making sure that it locks firmly in place.

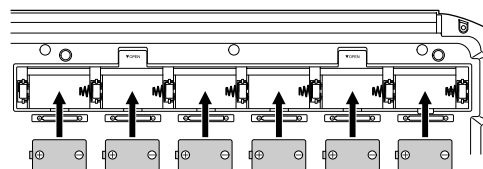
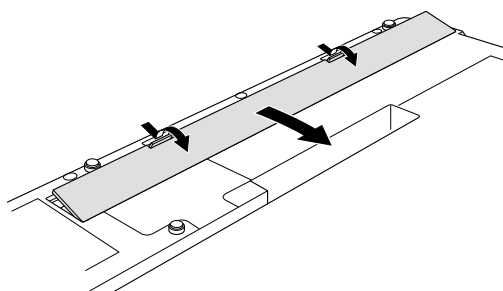

⚠ CAUTION

- When the batteries run down, replace them with a complete set of six new batteries. NEVER mix old and new batteries.
- Do not use different kinds of batteries (e.g. alkaline and manganese) at the same time.
- If the instrument is not to be in use for a long time, remove the batteries from it, in order to prevent possible fluid leakage from the battery.
- Plugging or unplugging the AC power adaptor while the batteries are installed will reset the PSR-550 to the defaults.

Important Notes on Battery Use

- Since the PSR-550 consumes a considerable amount of power, Yamaha recommends the use of an AC power adaptor rather than batteries. The batteries should be considered an auxiliary power source for data backup.
- The floppy disk drive, in particular, uses a large amount of power, so it is important to always use an AC power adaptor when performing disk-intensive operations such as song recording/playback or data load/save. If you attempt to use battery power for these operations and the batteries do fail, you will lose not only the data you’re recording or saving, but also other data in internal memory including user styles, user pads, registration memory, etc.
- Taking the above precautions into consideration, always use an AC power adaptor when using the PSR-550 for an important performance or when creating important data.

Demo Song Playback

Once you've set up your PSR-550, try listening to the pre-programmed demonstration songs. A total of 9 demo songs are provided. As the song plays back, the backlit LCD of the PSR-550 changes color.

1 Turn the power ON by pressing the [STANDBY/ON] switch.

Press the [STANDBY/ON] switch again to turn the power OFF.

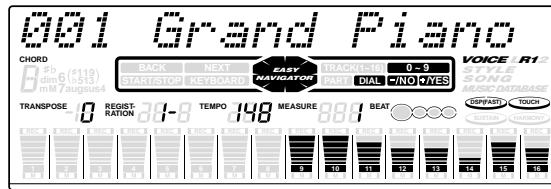

CAUTION

- Even when the switch is in the "STANDBY" position, electricity is still flowing to the instrument at the minimum level. When you are not using the PSR-550 for a long time, make sure you unplug the AC power adaptor from the wall AC outlet, and/or remove the batteries from the instrument.

2 Press the [DEMO] button to start demo playback.

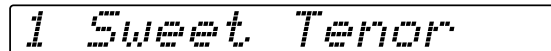

NOTE

- The LCD changes color during Demo song playback only if the Backlight mode is set to "Auto" (page 122).

3 Set a volume level with the [MASTER VOLUME] control.

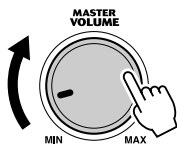

NOTE

- If you play the PSR-550 with the volume at its maximum level when the batteries are used, the life of the batteries will be shorter.

4 Skip to the beginning of a different demo song.

Use the data dial, the [+ / YES] button, the [- / NO] button or the number buttons [1]-[0].

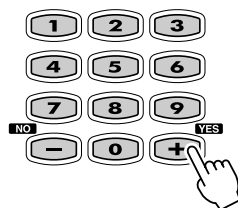
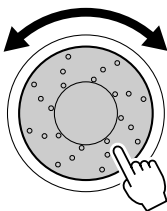

5 Press the [DEMO] button again to stop the demo song.

Using the Music Database

If you want to play in a certain genre of music but don't know which style (page 32) and voice (page 26) settings would be appropriate, simply select the desired genre from the Music Database. The PSR-550 automatically makes all appropriate panel settings to let you play in that music style!

1 Press the [MUSIC DATABASE] button.

The MUSIC DATABASE menu appears in the display.



NOTE

- Press the [MUSIC DATABASE] button to switch into the Style mode, turn AUTO ACCOMPANIMENT on, and turn SYNCHRONIZED START on. See page 25 for details.

2 Select a "Music Database."

Use the data dial, the [+ / YES] button, the [- / NO] button or the number buttons [1]-[0].

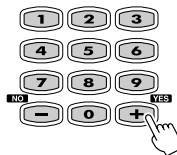
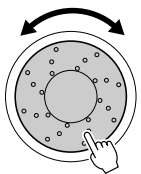

The PSR-550 has 220 panel setups in the Music Database and they are divided into eleven different categories. You can select different Music Database categories in succession by using the Direct Access function.

To select the first Music Database of the next available category, first press the [DIRECT ACCESS] button, then press the [MUSIC DATABASE] button.



Direct Access

029 Days of Sax

See page 21 for details about the Direct Access function.

In this example, we'll select #220 "Xmas Night" and play the song "Silent Night." (The sheet music is provided on the next page.)

220 Xmas Night

3 Play the chords with your left hand and the melody lines with your right hand along with the music.

As soon as you play a chord with your left hand, the auto accompaniment starts.

For information on how to enter chords, see "Chord Fingerings" on page 38.

NOTE

- See pages 32 through 41 for details about the Auto Accompaniment.

Music Database List (page 131)

POP HITS	
001	Alive Fever
002	Alive Synth
003	Croco Rock
...	
028	YesterGuitar
SWING & JAZZ	
029	Days of Sax
...	
056	Wonderland
EVERGREEN	
057	Black Forest
...	
086	Wonder World
...	

$\text{♩} = 100$ Silent Night

The control panel shows buttons for INTRO, MAIN/AUTO FILL, and ENDING/HI. Below these are buttons labeled A and B. An arrow points from the ENDING/HI button to the end of the music notation. To the right, a keyboard diagram shows the 'Auto Accompaniment section' highlighted, with a hand icon indicating a finger pressing a key.

4 When you reach the point in the music indicated by the arrow above, press the [ENDING] button.

When the ending is finished, the auto accompaniment automatically stops.

Data stored by the Music Database

Each of the Music Database settings has been specially programmed to match the selected style and each features the best suited voice (or combination of voices), style, and other settings for that style. Pressing the [MUSIC DATABASE] button and selecting a style lets you instantly reconfigure all relevant settings, conveniently allowing you to start playing in the desired genre with all the appropriate sounds — without having to make each setting one by one. For each parameter, refer to the following pages.

■ VOICE PARAMETERS

- Part on/off (Voice R1/R2/L) page 29
- Voice change setting (Voice R1/R2/L) page 75
- Mixer setting (Voice R1/R2/L) page 76
- DSP on/off, FIRST/SLOW on/off, DSP Type and Return Level page 49
- HARMONY/ECHO on/off, type, volume, part page 50
- Pitch Bend Range page 122
- Upper Octave setting page 119

■ AUTO ACCOMPANIMENT PARAMETERS

- Auto accompaniment (ACMP) on/off page 33
- Synchro Start = ON* page 33
- Style Number page 32
- Main A/B section page 34
- Tempo page 36
- Accompaniment Volume page 37
- Track on/off page 37
- Voice Change setting page 75
- Mixer setting page 75
- Multi Pad Bank number page 43
- Reverb setting page 46
- Chorus setting page 48

* Set only when the accompaniment is not playing.

Panel Display Indications

The PSR-550 features a large multi-function display that shows all important settings for the instrument. This backlit LCD also changes color depending on the selected mode, making operation even easier and more intuitive. For details about the LCD's Backlight mode, see page 122. The section below briefly explains the various icons and indications in the display.

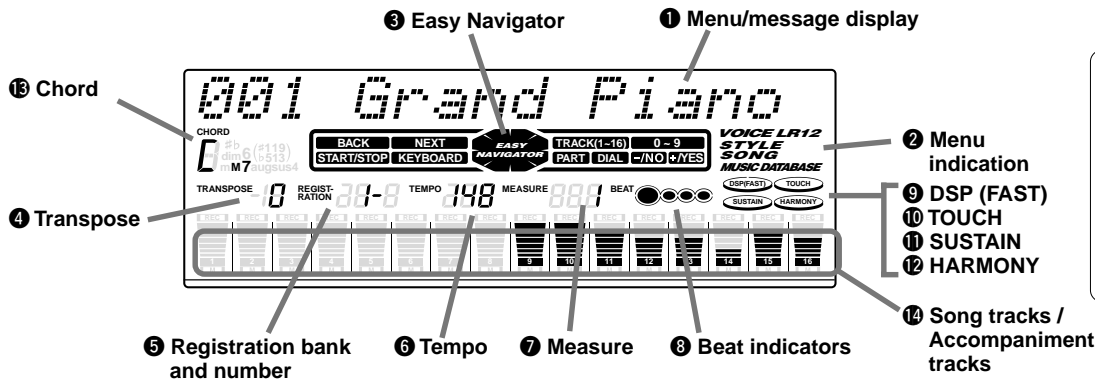

1 Menu/message display

This shows the menu for each function of the PSR-550. It also displays the relevant messages for the current operation. See the “Basic Operation” section (page 17) for details on the menu/message display.

2 Menu indication

This indicates the items shown in the menu display, and the button to be pressed. Refer to “Basic Operation” (page 17) for details.

3 Easy Navigator

This indicates the buttons to be pressed. Refer to “Basic Operation” (page 18) for details.

4 Transpose

Shows the current transpose value (page 30).

5 Registration bank-number

Shows the current selected registration memory bank and number (page 56).

6 Tempo

Shows the current tempo of accompaniment/song playback (page 36).

7 Measure

Indicates the current measure number during song recording and playback.

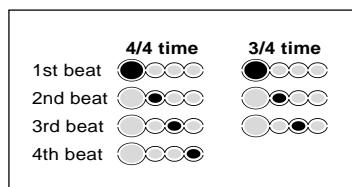

8 Beat indicators

Flashes at the current tempo and indicates the current beat during accompaniment and song playback.

9 DSP (FAST)

“DSP” appears when the DSP effect is turned on (page 49).

“FAST” appears when the DSP FAST/SLOW effect is turned on (page 49).

10 TOUCH

Appears when the touch sensitivity is turned on (page 120).

11 SUSTAIN

Appears when the sustain is turned on (page 30).

12 HARMONY

Appears when the HARMONY effect is turned on (page 50).

13 Chord

Displays the current chord name during AUTO ACCOMPANIMENT playback or SONG recording/playback (page 33).

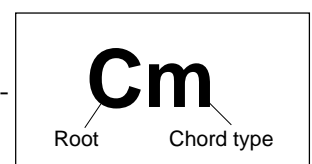

14 Song tracks / Accompaniment tracks

- **In the Song mode (page 25) and the Demo Song mode (page 15):**
The icons of all tracks indicate the on/off status and volume/velocity settings.
- **In the Style mode (page 25):**
The icons of tracks 9 - 16 indicate the on/off status and volume/velocity settings for each of the eight accompaniment tracks.
- **In the Record mode (page 25):**
The icons of all tracks indicate the on/off status and volume/velocity settings. The “REC” marks indicate the recording status.

Basic Operation

This section introduces you to the basic operations common to the various functions of the PSR-550. In particular, you'll learn how to use the menu/message display at the center of the front panel.

- Calling up the Operation Displays page 17
- How to read the Menu/message display and the “Easy Navigator” page 18
- Menu Selection page 19
- Changing (Editing) Values page 20
- Naming page 21
- Direct Access page 21

Calling up the Operation Displays

Press the buttons listed below in order to call up the appropriate displays for the various functions of the PSR-550.

- | | |
|--|---|
| • DEMO button page 13 | • MIXER button page 76 |
| • RECORD button pages 25, 78, 92, 96 | • ACMP/SONG VOL button pages 37, 70 |
| • SONG button page 25 | • TEMPO/TAP button page 36 |
| • STYLE button pages 25, 32 | • TRANSPOSE button page 30 |
| • MUSIC DATABASE button page 14 | • FUNCTION button page 118 |
| • VOICE L button page 28 | • DISK LOAD button page 62 |
| • VOICE R1 button page 26 | • DISK SAVE button page 60 |
| • VOICE R2 button page 27 | • DISK UTILITY button pages 64, 67 |
| • VOICE CHANGE button page 75 | |

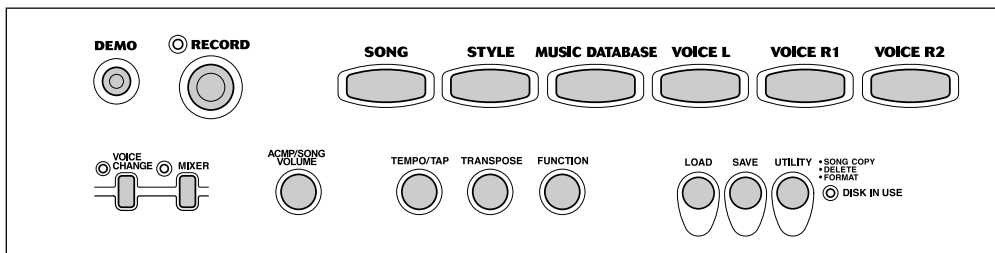

Pressing one of these buttons instantly calls up the relevant display for the selected function.

See the function tree chart for details (page 22).

If you've selected several different functions' displays in succession, you can “retrace your steps” and revisit each display by using the [BACK] and [NEXT] buttons at the left side of the display. Of course you can also directly select the desired displays by pressing the appropriate buttons (as listed above).



How to leave the current display

As shown in the function tree chart (page 22), there is a wide variety of functions on the PSR-550, each with its own corresponding display. In order to leave the display of each function press the [EXIT] button.



Since the PSR-550 has so many different displays, you may occasionally find yourself confused as to which operation's display is currently shown. If this happens, you can return to “home base” by pressing the [EXIT] button several times. This returns the PSR-550 to the default display — the same display that appears when the power is turned on.

How to Read the Menu/Message Display and "Easy Navigator"

Depending on the selected function or operation, the PSR-550 shows a variety of displays and indications. Included in these are "Easy Navigator" messages that guide you through the various operations.

Let's take a look at some examples:

● Voice

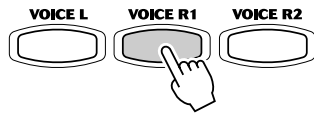

Press the [VOICE R1] button.



This message means: "The current voice for voice R1 (Grand Piano) is shown at top. You can change this voice by using the data dial, the [+ / YES] button, the [- / NO] button or the number buttons [1]-[0]."

● Style



Press the [STYLE] button.



This message means: "The current style (8Beat 1) is shown at top. You can change this style by using the data dial, the [+ / YES] button, the [- / NO] button or the number buttons [1]-[0]."

RT START/STOP
 ◎ -SONG

 ◎ -ACCOI

This message also means: "You can start the accompaniment by pressing the [START/STOP] button."

● Song

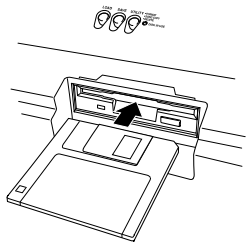

Insert the included data disk into the disk drive.



This message means: "The current song (CLUB_XG) is shown at top. You can change this song by using the data dial, the [+ / YES] button, the [- / NO] button or the number buttons [1]-[0]."

RT START/STOP
 ◎ -SONG

 ◎ -ACCOM

This message also means: "You can start the current song by pressing the [START/STOP] button."

● Disk

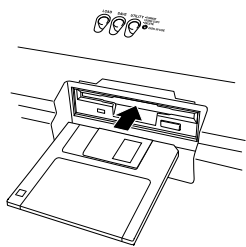

Insert an unformatted disk into the disk drive.



This message means: "Press the [+ / YES] button to execute the Format operation."

Menu Selection

For certain operations on the PSR-550 (such as selecting voices, demo songs and styles), you'll need to select different menus in the display.

For example, the display below (for selecting the function) appears when you press the [FUNCTION] button.



In this case you can select the function by turning the **data dial**, or move the cursor by pressing the [+ / YES] / [- / NO] buttons.



[+ / YES] button ↓ ↑ [- / NO] button



[+ / YES] button ↓ ↑ [- / NO] button



[+ / YES] button ↓ ↑ [- / NO] button



The display below (for selecting voices) appears when you press the [VOICE R1] button.



In this case you can also select the voice by using the **data dial** or the [+ / YES] / [- / NO] buttons as above; you can also input the voice number directly by using the number buttons [1] - [0] (see the next page).

Changing (Editing) Values

This section shows you how to set numeric values on the PSR-550, such as voice number, song/style number and various parameters. Input the values by using the number buttons [1]-[0] or the [+ / YES] / [- / NO] buttons.

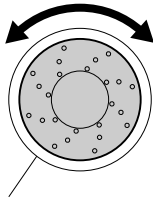

Rotating the data dial to the right (clockwise) increases the value, while rotating it to the left (counter-clockwise) decreases it.

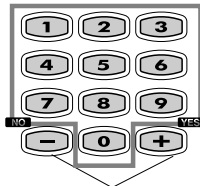

Number buttons [1]-[0] described below.

Pressing the [+ / YES] button increases the displayed value by 1. Pressing the [- / NO] button decreases the displayed value by 1. Pressing and holding either button causes a continuous increase and decrease. For items that have initial default values, pressing the [+ / YES] and the [- / NO] buttons together at the same time will return the setting to the initial value.

Numeric entry

The explanations here apply only to numbers that have a maximum of three digits, such as those for voices and styles.

• Entering one- or two-digit numbers

One- or two-digit voice numbers can be entered with leading zeroes: e.g. “12” can be entered as “012” by pressing the [0], [1] and [2] buttons in sequence.

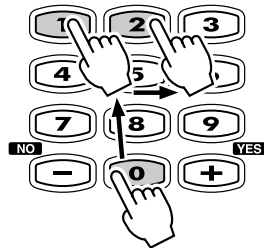

NOTE

- One- or two-digit numbers can also be entered without leading zeroes. To select number “12”, for example, simply press the [1] button and then the [2] button. The bars below the number on the display will flash for a few seconds, and then disappear when the selected number has been recognized by the PSR-550.

• Entering three-digit numbers

The number buttons can be used to directly enter the number of the desired voice, thereby immediately selecting that voice without having to step through a number of other voices. To select number 106, for example, press the [1], [0] and [6] number buttons in sequence.

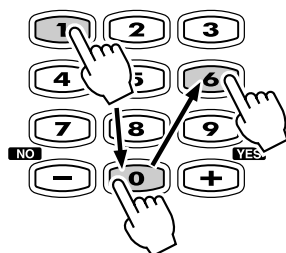

Naming

The allows you to create your own original data such as songs, styles and registration memory settings. You can also freely name the data as desired.

The following data types can be named.

- Disk files (User songs, etc) pages 61, 65, 66, 90
- User Styles page 104
- User Pad banks page 94
- Registration Memory banks page 56

The example display below appears when naming a song on a floppy disk (page 90).

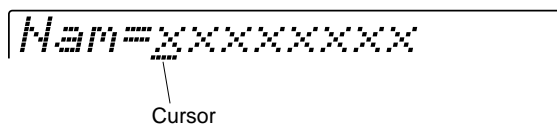

To enter an original name, use the keyboard.

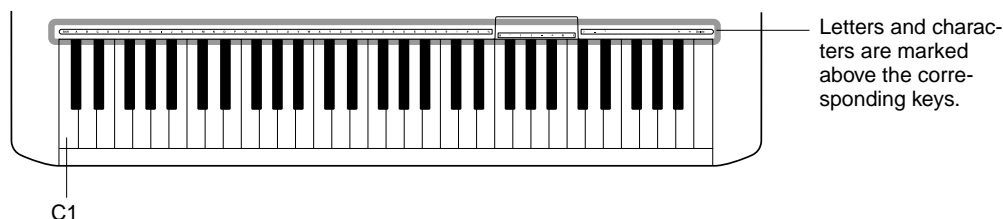

Entering a character	Each key on the keyboard enters a different character, as marked directly above the key.
Moving the cursor	The A#5 and B5 keys move the cursor backward and forward within the file name.
Entering a lower-case character	The C1 key functions as a shift key that shifts between lower- and upper-case characters: hold the Shift key while pressing a character key to enter the lower-case character.
Delete	The Delete key (C6) deletes the character at the cursor position.

NOTE
 • Lowercase letters cannot be used for disk file names.





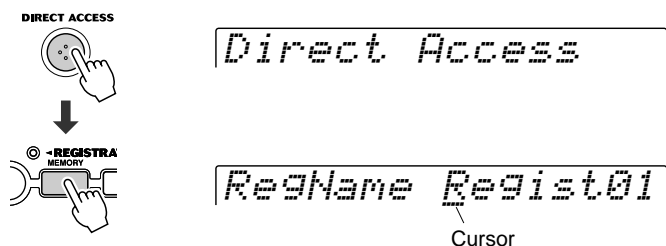



















DIRECT ACCESS



By using the [DIRECT ACCESS] button, you can instantly call up the desired display. For example, pressing the [DIRECT ACCESS] button and press the [REGISTRATION MEMORY] button automatically selects the display for inputting the Registration Memory bank name.



See page 24 for the Direct Access Chart.

Function Tree

Button	Menu/message display	Function	See page
DEMO	Sweet Tenor	Demo song selection	13
VOICE R1	001 Grand Piano	Voice R1 selection	26
VOICE R2	001 Grand Piano	Voice R2 selection	27
VOICE L	001 Grand Piano	Voice L selection	28
STYLE	001 8Beat 1	Accompaniment Style selection	 1 32
SONG	001 CLUB_XG	Song selection	68
	SngMenu	Song menu selection	69
	PlayMode	Song play method selection	 69
	Measure	Song Measure from which to start playback	 71
	AbRepeat	Song repeat setting	 72
	S.Trans	Song transpose setting	 3 73
MUSIC DATABASE	001 Alive Fever		 4 14
VOICE CHANGE	R1=001 Grand Pno	Voice selection of R1/R2/L/Style track/Song track	75
MIXER	Volume R1	Volume adjustment of Voice R1/R2/L	 5,6,7 76
	Volume Ph1	Volume adjustment of the accompaniment track	 76
	Volume T01	Volume adjustment of the song track	 76
	Octave R1	Octave setting of voice R1/R2/L	 8,9,10 77
	Octave T01	Octave setting of song track	 77
	Pan R1	Pan setting of voice R1/R2/L	 77
	Pan RhM	Pan setting of accompaniment track	 77
	Pan T01	Pan setting of song track	 77
	RevDepth R1	Reverb depth setting of voice R1/R2/L	 27 77
	RevDepth RhM	Reverb depth setting of accompaniment track	 27 77
	RevDepth T01	Reverb depth setting of song track	 27 77
	ChoDepth R1	Chorus depth setting of voice R1/R2/L	 30 77
	ChoDepth RhM	Chorus depth setting of accompaniment track	 30 77
	ChoDepth T01	Chorus depth setting of song track	 30 77
DspDepth R1	DSP depth setting of voice R1/R2/L	 33 77	
DspDepth RhM	DSP depth setting of accompaniment track	 33 77	
DspDepth T01	DSP depth setting of song track	 33 77	
ACMP/SONG VOL	Acmp Volume	Accompaniment Volume setting	37
	Song Volume	Song Volume setting	70
TRANPOSE	Transpose	Transpose setting	30
TEMPO/TAP	Tempo	Tempo setting	36
DISK LOAD	Ld	Loading data from a disk	62
DISK SAVE	Sv	Saving data to a disk	60
DISK UTILITY	Menu		
	SongCopy	Copying a song in a disk	64
	Delete	Deleting a file in a disk	67
	Format	Formatting a disk	 11 60

- The  icon in the chart indicates that the relevant function or parameter can be called up via the Direct Access function, and the numbers beside the icon correspond to the ones in the Direct Access Chart on page 24. All functions indicated with this mark (other than Style selection, Music Database selection, and Disk Format) can be user-assigned to the [+/**YES**] button, [-/**NO**] button and the number buttons [**1**]-[**0**] — allowing you to instantly select the desired function/parameter.
- When you call up the Mixer screens (other than Volume and Octave) via the Direct Access, the previously edited part (page 74) will be displayed.
- Concerning  1 and  4, the screens that are called up actually are different from the ones described at the left. See the Direct Access Chart on page 24.

Button	Menu/message display	Function	See page
FUNCTION			
	F1 Multi Pad		
	PBnk	Multi pad bank selection	12 44
	CdMatch	Chord match on/off setting	13 43
	F2 Regist Memory		
	RBNk	Registration Memory bank selection	14 56
	RegName	Naming Registration Memory bank	15 56
	F3 DigitalEffect		
	Reverb		
	RevType	Reverb type selection	25 46
	RevRetnLevel	Reverb return level setting	26 47
	Chorus		
	ChoType	Chorus type selection	28 48
	ChoRetnLevel	Chorus return level setting	29 48
	Dsp		
	DspType	DSP type selection	16,31 49
	DspRetnLevel	DSP return level setting	32 49
	Harmony		
	HTyp	Harmony/Echo type selection	17,34 50
	Harmony Vol	Harmony /Echo volume setting	24 52
	HarmPart	Harmony part setting	35 53
	F4 Midi		
	Template	MIDI template vselection	112
	MidiTemplatLoad?	Loading the selected MIDI template setting	112
	Transmit Ch	MIDI transmit channel setting	114
	Recive Ch	MIDI receive channel setting	115
	LocalContrl	Local control on/off setting	116
	Clock	External /Internal clock selection	116
	Init Send	Initial data send	117
	F5 Utility		
	Metronom	Metronome on/off setting	18 118
	UpperOct	Upper octave setting	119
	Tuning	Master tuning setting	119
	SC.Tune	Scale tuning setting	119
	Template	Scale tuning template selection	119
	NoteEdit	Individual note tuning	119
	Split	Split point setting	19 120
	Fingerng	Fingering selection	20 38
	TouchSns	Touch sensitivity setting	21 120
	VoiceSet	Voice set on/off setting	22 120
	Pedal	Selecting footswitch function	121
	PitchBnd	Pitch bend range setting	122
	Assignbl	Direct Access setting	122
	BackLigt	LCD's backlight color setting	23 122
RECORD			
	Song		
	QuickRec	User Song Quick recording	80
	MultiRec	User Song Multi track recording	82
	Punch In/Out	Punch in/out setting	84
	RecStart Mes	Measure from which to start playback	84
	Edit		
	Quantize	Quantize	86
	Setup Dt	Setup data editing	88
	Name	Naming User Songs	90
	Clear	Clearing user song data	91
	Style		
	Record	User Style recording	96
	Edit		
	Quantize	Quantize	102
	Name	Naming User Styles	104
	Clear	Clearing user style data	104
	MultiPad		
	Record	User Pad recording	92
	Edit		
	ChdMatch	Chord match on/off setting	94
	Name	Naming user pads	94
	Clear	Clearing user pad data	95

Function Tree number/function		Operation:  + button listed below
1	Next style category selection	[STYLE]
2	Song repeat setting	[SONG]*
3	Song transpose setting	[TRANPOSE]*
4	Next Music database category selection	[MUSIC DATABASE]
5	Volume adjustment of Voice R1	[VOICE R1]
6	Volume adjustment of Voice R2	[VOICE R2]
7	Volume adjustment of Voice L	[VOICE L]
8	Octave setting of Voice R1	PART ON/OFF [VOICE R1]
9	Octave setting of Voice R2	PART ON/OFF [VOICE R2]
10	Octave setting of Voice L	PART ON/OFF [VOICE L]
11	Formatting a disk	[UTILITY]
12	Multi pad bank selection	MULTI PAD [STOP]
13	Chord match on/off setting	MULTI PAD [1]-[4]
14	Registration Memory bank selecton	REGISTRATION MEMORY [1]-[4]
15	Naming Registration Memory bank	REGISTRATION MEMORY [MEMORY]
16	DSP type selection	[DSP] or [FAST/TAP]
17	Harmony/Echo type selection	[HARMONY]
18	Metronome on/off setting	[TEMPO/TAP]
19	Split point settiong	[SONG/ACMP VOLUME]
20	Fingering selection	[ACMP ON/OFF]
21	Touch sensitivity setting	[TOUCH]
22	Voice set on/off setting	[FUNCTION]
23	LCD's backlight color setting	[DEMO]
24	Harmony/Echo volume setting	Number button [0]
25	Reverb type selection	Number button [1]
26	Reverb return level setting	Number button [2]
27	Reverb depth setting	Number button [3]
28	Chorus type selection	Number button [4]
29	Chorus return level setting	Number button [5]
30	Chorus depth setting	Number button [6]
31	DSP type selection	Number button [7]
32	DSP return level setting	Number button [8]
33	DSP depth setting	Number button [9]
34	Harmony/Echo type selection	Number button [-/NO]
35	Harmony part setting	Number button [+ /YES]

* Available only in the Song mode.

Various functions other than ones listed above can be accessed by assigning them to the [+ /YES] button, [- /NO] button and the number buttons [1]-[0].

The functions listed above are default settings.

See the Function Tree on pages 22 and 23 for the available functions.

See page 122 about how to assign the available functions.

Mode

Depending on the panel operation used, the PSR-550 has several fundamentally different conditions (or methods of operation). Each of these condition is called a mode. This section explains the main modes of the instrument.

Style Mode

page 32

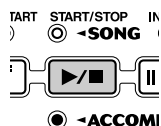

Select this mode by pressing the [STYLE] button or the [MUSIC DATABASE] button. (This is the default mode when the power is turned on.)

The Style mode is used for playing the full keyboard normally, and when using the auto accompaniment.

Styles are the rhythm/accompaniment patterns which are played by the auto accompaniment feature.

In the Style mode, the backlight color is set to blue as the factory default.

● **Auto accompaniment (ACMP) on/off** page 33

The [ACMP ON/OFF] button switches on and off. When auto accompaniment is on, the left side of the keyboard is used for playing/indicating chords.



● **Synchronized Start standby (SYNC START) on/off** page 33

The [SYNC START] button switches on and off. When Synchronized Start standby is on, the auto accompaniment starts as soon as you play a key on the keyboard.

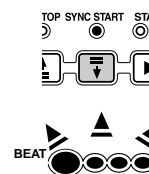

Song Mode

page 68



Select this mode by pressing the [SONG] button or inserting the disk that contains song data into the disk drive.

The Song mode is used for playing the full keyboard normally, and for playing back the songs.

In the Song mode, the backlight color is set to purple as the factory default.

Record Mode



Select this mode by pressing the [RECORD] button.

In the Record mode you can record your own original performances and songs, create original styles and Multi Pad phrases.

In the Record mode, the backlight color is set to red as the factory default.

● **Song record mode** page 78

- Rehearsal mode (Sync Start off)
- Record (Synchronized Start) standby
- Recording

● **Style record mode** page 96

- Rehearsal mode (Sync Start off)
- Record (Synchronized Start) standby
- Recording

● **Pad record mode** page 92

- Rehearsal mode (Sync Start off)
- Record (Synchronized Start) standby
- Recording

When Record (Synchronized Start) standby is on, the recording starts as soon as you play a key on the keyboard.

Disk Mode

page 57

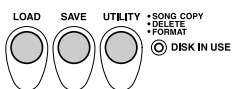

Select this mode by pressing the [LOAD] button, [SAVE] button or the [UTILITY] button.

In the Disk mode you can save and load important data.

In the Disk mode, no panel operations can be executed (except for disk operations).

In the Disk mode, the backlight color is set to blue as the factory default.

Playing Voices

The PSR-550 has a huge selection of various musical instrument voices which you can play. Try out the different voices referring to the voice list at the end of this manual (page 123).

Select and play the voices of different musical instruments

- Selecting a Voice page 26
- Keyboard Percussion page 31

Assign three different voices to the keyboard and play them

- Playing Two Voices (R1, R2) Simultaneously page 27
- Playing Different Voices with the Left (L) and Right (R1, R2) Hands page 28
- Functions of the Keyboard page 29

Other voice-related functions

- Pitch Bend Wheel page 30
- Transpose page 30
- Sustain page 30
- Touch Sensitivity page 120

Selecting a Voice

1 Press the [VOICE R1] button.

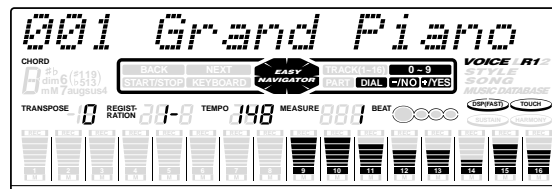
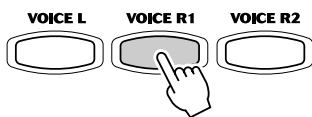

NOTE

- The voice selected here is called voice R1 (RIGHT 1). See page 29 for more information on voice R1.

2 Select a voice.

Use the **data dial**, the [+/**YES**] button, the [-/**NO**] button or the number buttons [1]-[0].

Refer to the Voice List (page 123).

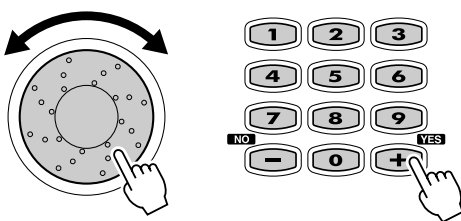

3 Play the keyboard and adjust the volume.

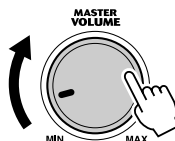

Playing Two Voices (R1, R2) Simultaneously

- 1 Press the [PART ON/OFF VOICE R2] button.

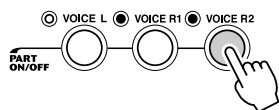

- 2 Play the voices.

Two different voices are sounded simultaneously in a layer.

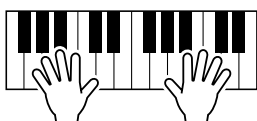

Voice R1 (RIGHT 1) is the first voice of the layer and is meant to be played with the right hand. The second voice is called voice R2 (RIGHT 2) and is also played with the right hand.

Selecting a voice for VOICE R2

- 1 Press the [VOICE R2] button.

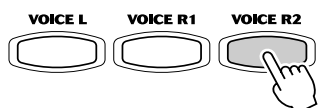

098 Slow Strings

- 2 Select a voice.

Use the **data dial**, the [+/**YES**] button, the [-/**NO**] button or the number buttons [1]-[0].

Refer to the Voice List (page 123).

The voices available for selection here (VOICE R2) are the same as those available for VOICE R1 (selected on page 26).

- 3 Play the voice.



Playing Different Voices with the Left (L) and Right (R1, R2) Hands

- 1 Press the [PART ON/OFF VOICE L] button.



- 2 Play the voices.

The notes you play with your right and left hands sound two different voices.

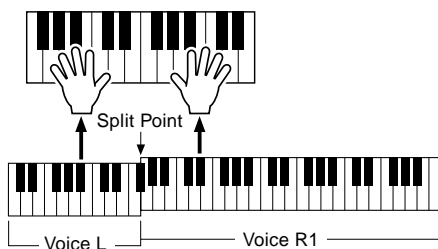

NOTE

- The point on the keyboard that separates voice L and voice R1 is called the "split point" (page 29).

Voice R1 (RIGHT 1) is meant to be played with the right hand. Voice L (LEFT) is played with the left hand.

Selecting a voice for VOICE L

- 1 Press the [VOICE L] button.

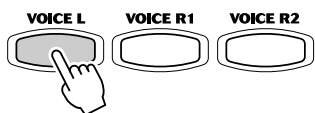

095 String Ensb1

- 2 Select a voice.

Use the **data dial**, the [+/**YES**] button, the [-/**NO**] button or the number buttons [1]-[0].

Refer to the Voice List (page 123).

The voices available for selection here (VOICE L) are the same as those available for VOICE R1 (selected on page 26).

- 3 Play the voices.

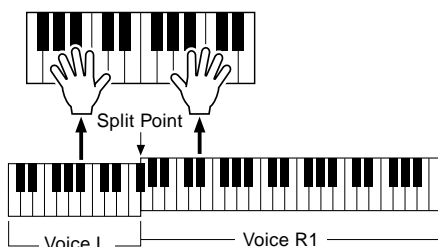

Split Point

The point on the keyboard that separates voice L and voice R1/R2 is called the “split point”.

The split point is set to F#2 at the factory setting, however you can set this to any key you wish. Refer to page 120 for instructions on setting the split point.

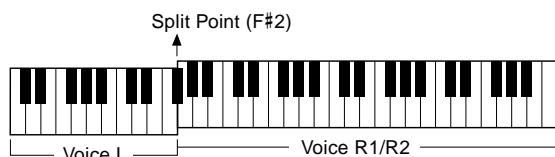

NOTE

- Each key has a note name; for example, the lowest (farthest left) key on the keyboard corresponds to C1, and the highest (farthest right) key to C6. (See below for details.)

Functions of the Keyboard

As explained above, the keyboard of the PSR-550 can sound three different voices. Here’s a short summary of the various ways of playing voices.

● Playing a Single Voice



● Playing Two Voices

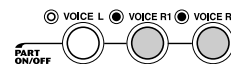

● Playing Separate Voices with the Right and Left Hands

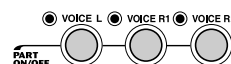
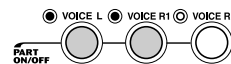

In addition, the keyboard of the PSR-550 has other important functions besides playing voices (as shown below).

● Auto Accompaniment Section

When the auto accompaniment is set to on (page 33), the key range of voice L becomes the range for playing/indicating chords.

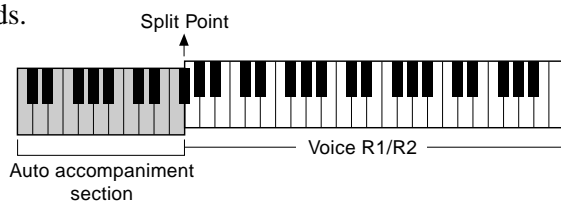

● Naming

The keyboard can also be used to name song files on a floppy disk, User Styles, User Pad banks and Registration Memory banks (page 21).

Each key has a note name; for example, the lowest (farthest left) key on the keyboard corresponds to C1, and the highest (farthest right) key to C6.

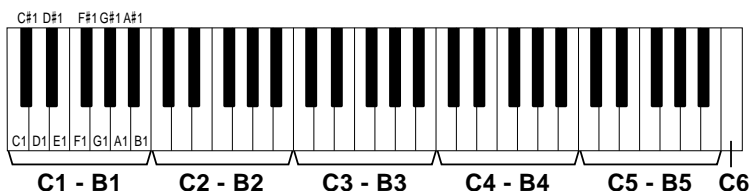

Transpose

This function allows the overall pitch of the PSR-550 to be transposed up or down by a maximum of one octave in semitone increments. The transpose range is from -12 to +12.

1 Press the [TRANPOSE] button.



Transpose = 0

2 Set the transposition.

Use the **data dial**, the [+ / YES] button, the [- / NO] button or the number buttons [1]-[0].

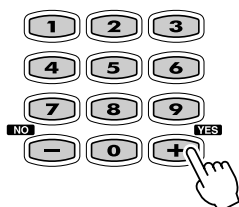
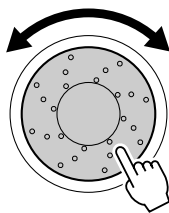

Transpose = 4

NOTE

- The Transpose function cannot be applied when a drum kit is the selected voice (page 31).
- Press the [+ / YES] and [- / NO] buttons simultaneously to instantly reset the transpose value to "0".
- The new TRANSPOSE value will take effect from the next key played.
- Minus values can be entered by using the number buttons while holding the [- / NO] button.

Pitch Bend Wheel

Use the PSR-550 pitch bend wheel to bend notes up (roll the wheel away from you) or down (roll the wheel toward you) while playing the keyboard. The pitch bend wheel is self-centering and will automatically return to normal pitch when released.

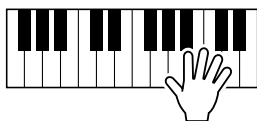
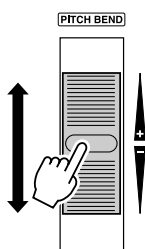

NOTE

- The maximum pitch bend range can be set via the Pitch Bend Range function in the Utility function group (page 122).

Sustain

When the Sustain features is ON, all notes played on the keyboard have a longer sustain. Press the [SUSTAIN] button to turn the SUSTAIN effect ON or OFF.

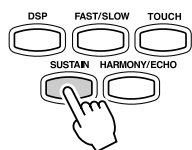

Keyboard Percussion

1 Press the [VOICE R1] button.

2 Select “StandardKit1”.

Use the **data dial**, the [+ / YES] button, the [- / NO] button or the number buttons [1]-[0].



3 Play the voice.

Refer to the illustration below and the drum kit list at the end of the manual (page 128).

The drum and percussion instrument sounds for the standard kit (Std.Kit1) are indicated by symbols printed below the keys.

NOTE

- The Transpose function cannot be applied when a drum kit is the selected voice (page 30).
- Each key has a note name; for example, the lowest (farthest left) key on the keyboard corresponds to C1, and the highest (farthest right) key to C6. (See page 29 for details.)

[Standard Kit 1]

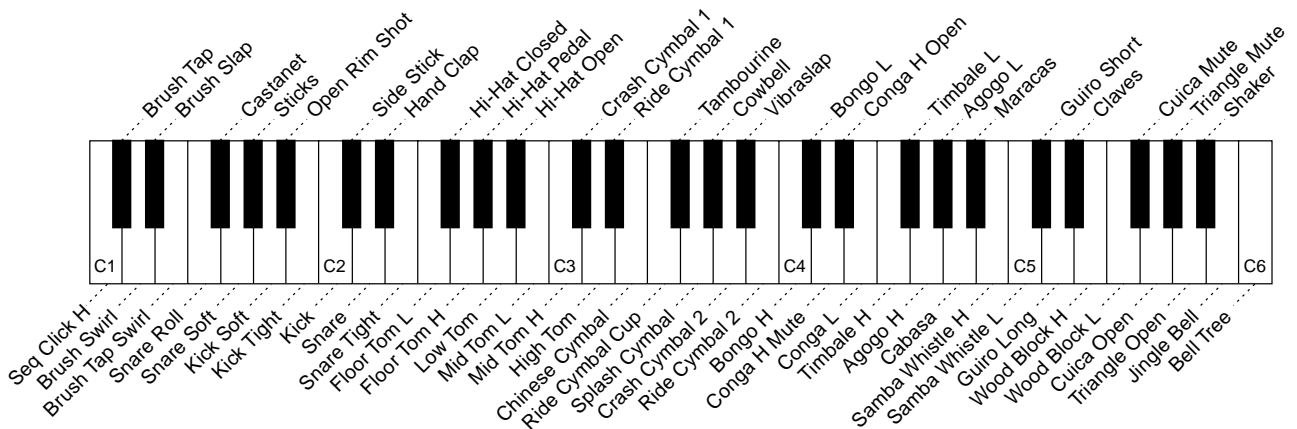

Auto Accompaniment

The auto accompaniment feature puts a full backing band at your fingertips. To use it, all you have to do is play the chords with your left hand as you perform, and the selected accompaniment style matching your music will automatically play along, instantly following the chords you play. With auto accompaniment, even a solo performer can enjoy playing with the backing of an entire band or orchestra.

The PSR-550 features a total of 112 styles or accompaniment patterns (style numbers 1 - 112) in a variety of different musical genres. Try selecting some of the different styles (page 130) and play with the auto accompaniment.

Two ways to playback the auto accompaniment

- Using Auto Accompaniment (rhythm track only) page 32
- Using Auto Accompaniment (all tracks) page 33

Additional functions for getting the most out of the auto accompaniment

- Accompaniment Sections page 34
- Tempo / Tap page 36
- Accompaniment Track Muting page 37
- Accompaniment Volume Control page 37

Auto accompaniment functions related to your left hand chord playing

- Chord Fingerings page 38
- Accompaniment Split Point page 40
- Synchro Stop page 41

Automatic one-touch selection of a variety of specially programmed panel settings to match the auto accompaniment style

- One Touch Setting page 42

Using Auto Accompaniment (rhythm track only)

1 Press the [STYLE] button.



2 Select a style.

Use the **data dial**, the [+ / YES] button, the [- / NO] button or the number buttons [1]-[0].

Refer to the Style List (page 130).

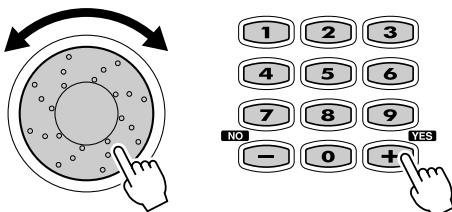

NOTE

- You can select successive Style categories by using the Direct Access function. The method is the same as for selecting Music Database categories. Refer to step #2 in "Using the Music Database" on page 14. Also refer to the Style categories printed on the panel.

3 Press the [START/STOP] button to start the rhythm tracks of the auto accompaniment, minus the bass and chord tracks.

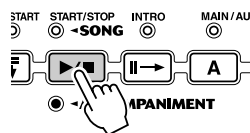

4 Press the [START/STOP] button again to stop the accompaniment.

Using Auto Accompaniment (all tracks)

1 Press the [STYLE] button.

2 Select a style.

Use the **data dial**, the [+/**YES**] button, the [-/**NO**] button or the number buttons [1]-[0].

Refer to the Style List (page 130).

3 Turn **AUTO ACCOMPANIMENT** on.

Press the [ACMP ON/OFF] so that its indicator lights.

The specified left-hand section of the keyboard becomes the “Auto Accompaniment” section, and chords played in this section are automatically detected and used as a basis for fully automatic accompaniment with the selected style.

NOTE
 • [ACMP] is the abbreviation of [ACCOMPANIMENT].

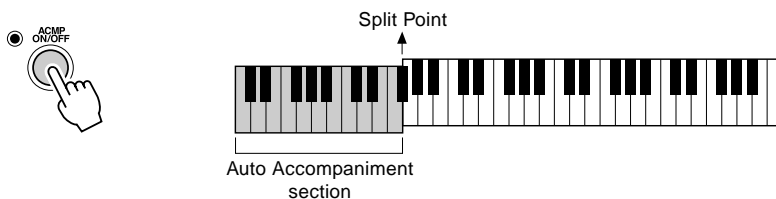

4 Turn **SYNCHRONIZED START** on.

Press the [SYNC START] button so that its indicator lights.

The beat lamp also flashes in time with the tempo. This condition is called synchronized start standby. Refer to page 25 for details.

NOTE
 • [SYNC START] is the abbreviation of [SYNCHRONIZED START].



5 As soon as you play a chord with your left hand, the auto accompaniment starts.

For this example, play a C major chord (as shown below).

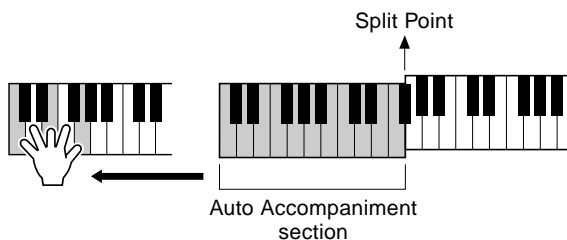

CHORD
 #b (#119)
 dim 6 (b513)
 mM 7augus4

6 Try playing other chords with your left hand.

For information on how to enter chords, see “Chord Fingerings” on page 38.

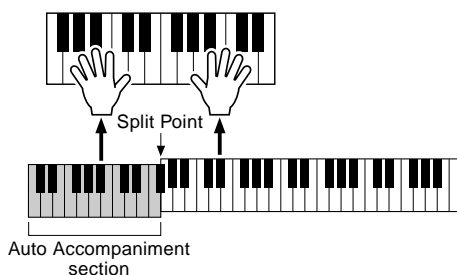

7 Press the [START/STOP] button again to stop the accompaniment.

Accompaniment Sections

There are various types of Auto Accompaniment sections that allow you to vary the arrangement of the accompaniment to match the song you are playing. They are: Intro, Main A and B, Fill-in and Ending. By switching among them as you play, you can easily produce the dynamic elements of a professional-sounding arrangement in your performance.

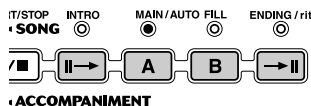

● INTRO Section

This is used for the beginning of the song. When the intro finishes playing, accompaniment shifts to the main section.

The length of the intro (in measures) differs depending on the selected style.

● MAIN Section

This is used for playing the main part of the song. It plays an accompaniment pattern of several measures (2 - 4 measures), and repeats indefinitely until another section's button is pressed. There are two variations on the basic pattern, A - B, and the auto accompaniment changes harmonically based on the chords you play with your left hand.

● FILL-IN Section

The fill-in sections let you add dynamic variations and breaks in the rhythm of the accompaniment, to make your performance sound even more professional. Simply press one of the MAIN/AUTO FILL (A, B) buttons as you play, and the selected fill-in section plays automatically (AUTO FILL), spicing up the auto accompaniment. When the fill-in is finished, it leads smoothly into the selected main section (A, B).

● ENDING Section

This is used for the ending of the song. When the ending is finished, the auto accompaniment stops automatically. The length of the ending (in measures) differs depending on the selected style.

1 Press the [STYLE] button.

2 Select a style (page 32).

Use the **data dial**, the [+ / YES] button, the [- / NO] button or the number buttons [1]-[0].

3 Turn **AUTO ACCOMPANIMENT** on (page 33).

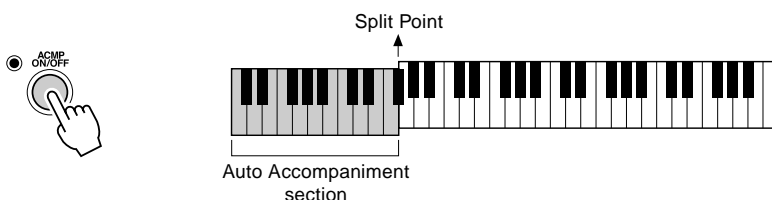

NOTE

• [ACMP] is the abbreviation of [ACCOMPANIMENT] and [SYNC START] is that of [SYNCHRONIZED START].

4 Turn **SYNCHRONIZED START** on (page 33).



5 Press the [MAIN A] button.

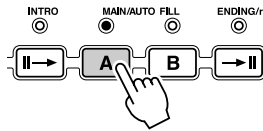

6 Press the [INTRO] button.

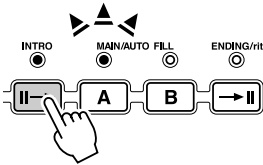

7 As soon as you play a chord with your left hand, the auto accompaniment starts.

For this example, play a C major chord (as shown below).

For information on how to enter chords, see “Chord Fingerings” on page 38.

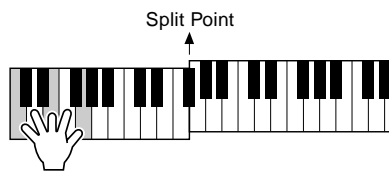

When the playback of the intro is finished, it automatically leads into main A section.

8 Press the [MAIN B] button.

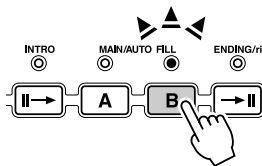

A fill-in plays, automatically followed by the main B section.

9 Press the MAIN buttons as desired during your performance.

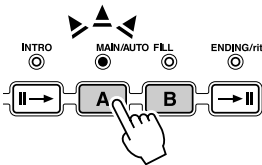

The main section corresponding to the pressed button plays following an automatic fill-in.

10 Press the [ENDING] button.

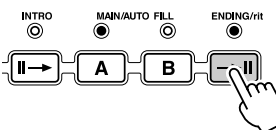

This switches to the ending section. When the ending is finished, the auto accompaniment automatically stops.

You can have the ending gradually slow down (ritardando) by pressing the [ENDING] button again while the ending is playing back.

NOTE

- The indicator of the destination section (MAIN A or B) will flash while the corresponding fill-in is playing. During this time you can change the destination section by pressing the appropriate MAIN/AUTO FILL [A] or [B] button.
- You can use the intro section even in the middle of the song by pressing the [INTRO] button during the song.
- If the MAIN/AUTO FILL A/B button is pressed after the final half beat (eighth note) of the measure, fill-in will begin from the next measure.

NOTE

- If you press the [INTRO] button while the ending is playing, the intro section will begin playing after the ending is finished.
- If you press a MAIN/AUTO FILL button while the ending is playing, the fill-in accompaniment will immediately start playing, continuing with the main section.
- If you press the [SYNC START] button while the accompaniment is playing, the accompaniment will stop and the PSR-550 will enter Synchronized Start standby status.
- You can begin the accompaniment by using the ending instead of the intro section.

Tempo/Tap

Each style of the PSR-550 has been programmed with a default or standard tempo; however, this can be changed by using the [TEMPO/TAP] button.

You can change the tempo to any value between 32 and 280 beats per minute. The following steps can be used even during playback.

1 Press the [TEMPO/TAP] button.



Tempo = 148

NOTE

• When you select a different style while the accompaniment is not playing, the "default" tempo for that style is also selected. If the accompaniment is playing, the same tempo is maintained even if you select a different style.

2 Change the tempo.

Use the data dial, the [+ / YES] button, the [- / NO] button or the number buttons [1]-[0].

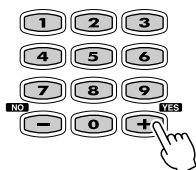
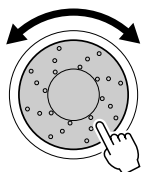

Tempo = 124

3 To restore the default tempo setting, press the [+ / YES] / [- / NO] buttons simultaneously.

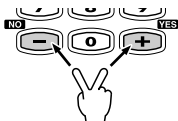

Tempo = 148

Using the Tap function

The auto accompaniment can be started at any tempo you desire by "tapping" out the tempo with the [TEMPO/TAP] button.

1 Press the [STYLE] button.

2 Select a style (page 32).

Use the data dial, the [+ / YES] button, the [- / NO] button or the number buttons [1]-[0].

3 Press the [TEMPO/TAP] button four times successively (in a consistent rhythm).

● When a 4-beat style is selected

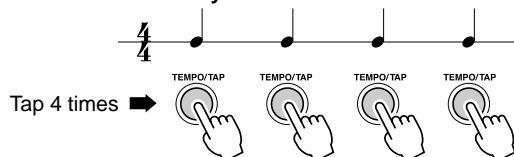

* When a 3-beat style is selected, tap 3 times.

NOTE

• The Tempo can also be changed during playback by tapping the TEMPO/TAP button twice at the desired tempo.

The auto accompaniment starts automatically at the tempo you tapped the button.

Accompaniment Track Muting

The PSR-550 has eight accompaniment tracks — RHYTHM SUB, RHYTHM MAIN, BASS, CHORD 1, CHORD 2, PAD, PHRASE 1 and PHRASE 2 — that you can control to modify the “orchestration” and therefore the overall sound of the accompaniment. When a style is selected, the icons corresponding to the tracks which contain data for any section of that style will light.

Individual accompaniment tracks can be turned OFF (muted) or ON by pressing the TRACK buttons (9 - 16) corresponding to the target tracks. The [M] icon will appear when a track is muted. By turning the tracks OFF and ON in different combinations, you can create various arrangements from a single accompaniment style.

Track contents

● RHYTHM SUB, RHYTHM MAIN

These are the main rhythm tracks. The RHYTHM tracks produce the drum and percussion sounds.

● BASS

The BASS track always plays a bass line, but the voice will change to fit the selected style ... acoustic bass, synth bass, tuba, etc.

● CHORD 1, CHORD 2

These tracks provide the rhythmic chordal accompaniment required by each style. You'll find guitar, piano and other chordal instruments here.

● PAD

This track plays long chords where necessary, using sustained instruments such as strings, organ, choir.

● PHRASE 1, PHRASE 2

This is where the musical embellishments reside.

The PHRASE tracks are used for punchy brass stabs, arpeggiated chords and other extras that make the accompaniment more interesting.

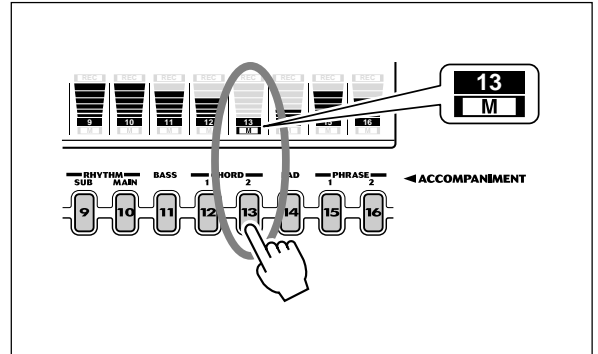

Accompaniment Volume Control

This separate volume control for the auto accompaniment lets you set the optimum level balance between the accompaniment and your right hand performance.

The accompaniment volume range is from “0” (no sound) to “127” (maximum volume).

- 1 Start the accompaniment (page 33).
- 2 Press the [ACMP/SONG VOLUME] button.



Acmp Volume = 100

- 3 Adjust the Accompaniment Volume.

Use the **data dial**, the [+ / YES] button, the [- / NO] button or the number buttons [1]-[0].

Adjust the level as you play the keyboard with your right hand, listening to the overall balance between the accompaniment and the keyboard-played voice.

- 4 Stop the accompaniment (page 33).

NOTE

- [ACMP] is the abbreviation of [ACCOMPANIMENT].

Chord Fingerings

The way in which chords are played or indicated with your left hand (in the auto accompaniment section of the keyboard) is referred to as “fingering”. There are 5 types of fingerings as described below.

NOTE
 • The default fingering mode is “Multi Finger”.

- Multi Finger page 40
- Single Finger page 38
- Fingered 1 page 38
- Fingered 2 page 40
- Full Keyboard page 40

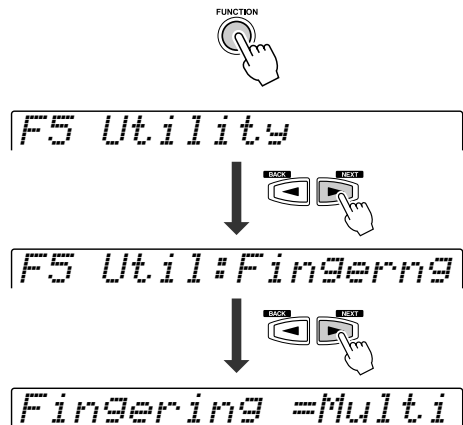

- 1 Press the [FUNCTION] button.
- 2 Select “Utility” by using the data dial, the [+ / YES] button or the [- / NO] button.
- 3 Press the [NEXT] button.
- 4 Select “Fingerng” by using the data dial, the [+ / YES] button or the [- / NO] button.
- 5 Press the [NEXT] button.
- 6 Select the way in which chords are played or indicated (Fingering) by using the data dial, the [+ / YES] button or the [- / NO] button.

The operations for each function corresponding to step #6 are covered in the following explanations.

The Single Finger mode

Fingering =Single

Single-finger accompaniment makes it simple to produce beautifully orchestrated accompaniment using major, seventh, minor and minor-seventh chords by pressing a minimum number of keys on the Auto accompaniment section of the keyboard. The following abbreviated chord fingerings are used:



• For a major chord, press the root key only.



• For a seventh chord, simultaneously press the root key and a white key to its left.



• For a minor chord, simultaneously press the root key and a black key to its left.



• For a minor-seventh chord, simultaneously press the root key and both a white and black key to its left.

The Fingered 1 mode

Fingering =F1

The Fingered 1 mode lets you finger your own chords on the Auto accompaniment section of the keyboard (i.e. all keys to the left of and including the split-point key — normally F#2) while the PSR-550 supplies appropriately orchestrated rhythm, bass and chord accompaniment in the selected style.

The Fingered 1 mode recognizes the following chords:

● Example for “C” chords

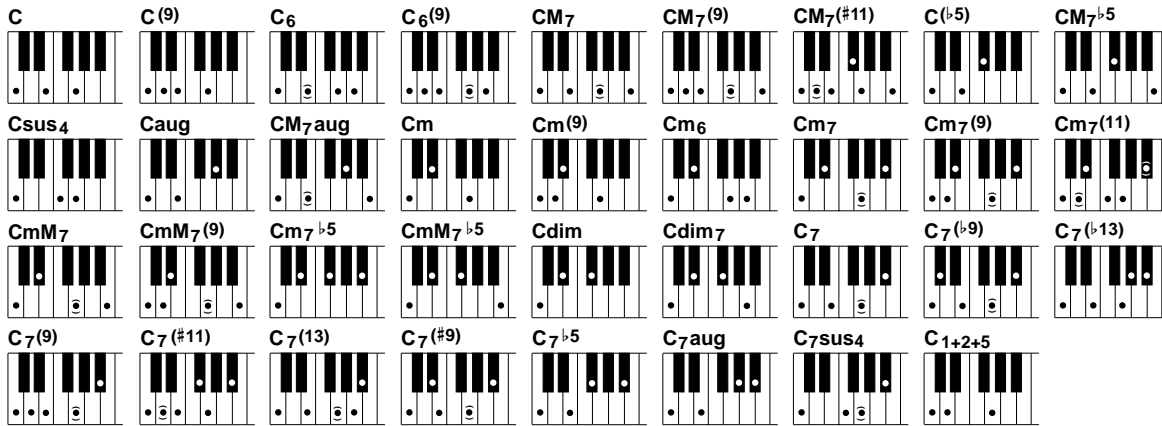

Chord Name/[Abbreviation]	Normal Voicing	Chord (C)	Display
Major [M]	1 - 3 - 5	C	C
Add ninth [(9)]	1 - 2 - 3 - 5	C(9)	C(9)
Sixth [6]	1 - (3) - 5 - 6	C6	C6
Sixth ninth [6(9)]	1 - 2 - 3 - (5) - 6	C6(9)	C6(9)
Major seventh [M7]	1 - 3 - (5) - 7 or 1 - (3) - 5 - 7	CM7	CM7
Major seventh ninth [M7(9)]	1 - 2 - 3 - (5) - 7	CM7(9)	CM7(9)
Major seventh add sharp eleventh [M7(#11)]	1 - (2) - 3 - #4 - 5 - 7 or 1 - 2 - 3 - #4 - (5) - 7	CM7(#11)	CM7(#11)
Flatted fifth [(♭5)]	1 - 3 - ♭5	C(♭5)	C(♭5)
Major seventh flatted fifth [M7♭5]	1 - 3 - ♭5 - 7	CM7♭5	CM7♭5
Suspended fourth [sus4]	1 - 4 - 5	Csus4	Csus4
Augmented [aug]	1 - 3 - #5	Caug	Caug
Major seventh augmented [M7aug]	1 - (3) - #5 - 7	CM7aug	CM7aug
Minor [m]	1 - ♭3 - 5	Cm	Cm
Minor add ninth [m(9)]	1 - 2 - ♭3 - 5	Cm(9)	Cm(9)
Minor sixth [m6]	1 - ♭3 - 5 - 6	Cm6	Cm6
Minor seventh [m7]	1 - ♭3 - (5) - ♭7	Cm7	Cm7
Minor seventh ninth [m7(9)]	1 - 2 - ♭3 - (5) - ♭7	Cm7(9)	Cm7(9)
Minor seventh add eleventh [m7(11)]	1 - (2) - ♭3 - 4 - 5 - (♭7)	Cm7(11)	Cm7(11)
Minor major seventh [mM7]	1 - ♭3 - (5) - 7	CmM7	CmM7
Minor major seventh ninth [mM7(9)]	1 - 2 - ♭3 - (5) - 7	CmM7(9)	CmM7(9)
Minor seventh flatted fifth [m7♭5]	1 - ♭3 - ♭5 - ♭7	Cm7♭5	Cm7♭5
Minor major seventh flatted fifth [mM7♭5]	1 - ♭3 - ♭5 - 7	CmM7♭5	CmM7♭5
Diminished [dim]	1 - ♭3 - ♭5	Cdim	Cdim
Diminished seventh [dim7]	1 - ♭3 - ♭5 - 6	Cdim7	Cdim7
Seventh [7]	1 - 3 - (5) - ♭7 or 1 - (3) - 5 - ♭7	C7	C7
Seventh flatted ninth [7(♭9)]	1 - ♭2 - 3 - (5) - ♭7	C7(♭9)	C7(♭9)
Seventh add flatted thirteenth [7(♭13)]	1 - 3 - 5 - ♭6 - ♭7	C7(♭13)	C7(♭13)
Seventh ninth [7(9)]	1 - 2 - 3 - (5) - ♭7	C7(9)	C7(9)
Seventh add sharp eleventh [7(#11)]	1 - (2) - 3 - #4 - 5 - ♭7 or 1 - 2 - 3 - #4 - (5) - ♭7	C7(#11)	C7(#11)
Seventh add thirteenth [7(13)]	1 - 3 - (5) - 6 - ♭7	C7(13)	C7(13)
Seventh sharp ninth [7(#9)]	1 - #2 - 3 - (5) - ♭7	C7(#9)	C7(#9)
Seventh flatted fifth [7♭5]	1 - 3 - ♭5 - ♭7	C7♭5	C7♭5
Seventh augmented [7aug]	1 - 3 - #5 - ♭7	C7aug	C7aug
Seventh suspended fourth [7sus4]	1 - 4 - (5) - ♭7	C7sus4	C7sus4
One plus two plus five [1+2+5]	1 - 2 - 5	C1+2+5	C

NOTE

- Notes in parentheses can be omitted.
- If you play any three adjacent keys (including black keys), the chord sound will be cancelled and only the rhythm instruments will continue playing (CHORD CANCEL function).
- Playing a single key or two same root keys in the adjacent octaves produces accompaniment based only on the root.
- A perfect fifth (1 + 5) produces accompaniment based only on the root and fifth which can be used with both major and minor chords.
- The chord fingerings listed are all in “root” position, but other inversions can be used — with the following exceptions:
 - m7, m7♭5, 6, m6, sus4, aug, dim7, 7♭5, 6(9), m7(11), 1+2+5.
- Inversion of the 7sus4 chord are not recognized if the 5th is omitted.
- The AUTO ACCOMPANIMENT will sometimes not change when related chords are played in sequence (e.g. some minor chords followed by the minor seventh).
- Two-note fingerings will produce a chord based on the previously played chord.

The Fingered 2 mode

Fingering =F2

This is essentially the same as the Fingered 1 mode, described above, except that the Fingered 2 mode additionally allows you to specify the lowest note of each chord — simply, the lowest note played in the Auto accompaniment section of the keyboard is used as the accompaniment bass note. This means you can specify “on-bass” chords in which the main bass note for the chord is not the root of the chord. For a C major chord, for example, you could use E (the third) or G (the fifth) as the bass note rather than C.



The Full Keyboard mode

Fingering =Full

When the Full Keyboard Mode is selected, the PSR-550 will automatically create appropriate accompaniment while you play just about anything using both hands, anywhere on the keyboard. You do not have to worry about specifying the accompaniment chords. The name of the detected chord will appear in the display.

NOTE

- When the Full Keyboard mode is selected, the split point setting (see below) for the auto accompaniment will be ignored.

The Multi Finger mode

Fingering =Multi

This is the default accompaniment mode. The Multi Finger mode automatically detects Single Finger or Fingered 1 chord fingerings, so you can use either type of fingering without having to switch fingering modes.

NOTE

- If you want to play minor, seventh or minor seventh chords using the Single Finger operation in the Multi Finger Mode, always press the closest white/black key(s) to the root of the chord.

Accompaniment Split Point

The point on the keyboard that separates the auto accompaniment section and the right-hand section of the keyboard is called the “split point”.

The initial setting (factory setting) of the split point is “F#2”; however, this can be set to any key you wish. Refer to page 118 for instructions on how to set the split point.

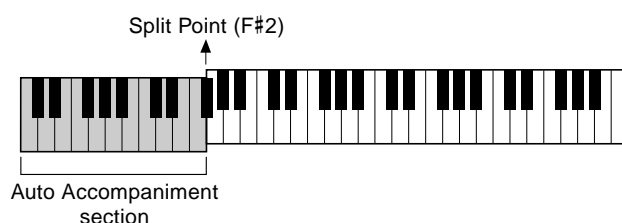

Synchro Stop

When the Synchro Stop function is engaged, accompaniment playback will stop completely when all keys in the auto-accompaniment section of the keyboard are released. Accompaniment playback will start again as soon as a chord is played. The BEAT indicators in the display will flash while the accompaniment is stopped.

- 1 Press the [STYLE] button.
- 2 Turn AUTO ACCOMPANIMENT on (page 33).
- 3 Turn SYNCHRONIZED START on (page 33).
- 4 Turn SYNCHRONIZED STOP on.

Press the [SYNC STOP] button.

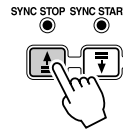

- 5 As soon as you play a chord with your left hand, the auto accompaniment starts.

For this example, play a C major chord (as shown below).

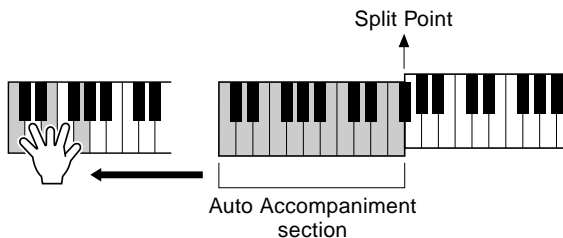

- 6 The auto accompaniment stops when you release your left hand from the keys.

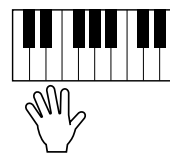

- 7 Playing a chord with your left hand automatically restarts the auto accompaniment.

To stop the auto accompaniment, simply release your left hand from the keyboard.

- 8 Turn SYNCHRONIZED STOP off.

Press the [SYNC STOP] button.

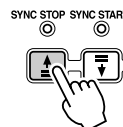

When Synchronized Stop is off, the auto accompaniment does not stop when you release your left hand from the keys.

- 9 Stop the accompaniment (page 33).

NOTE

- *Synchro Stop cannot be set to on when the fingering mode is set to Full Keyboard or the auto accompaniment on the panel is set to off. Also, Synchro Stop automatically turns off when Full Keyboard is selected for the fingering mode or when the auto accompaniment on the panel is turned off.*
- *[SYNC STOP] is the abbreviation of [SYNCHRO STOP].*

One Touch Setting

One Touch Setting is a powerful and convenient function that lets you instantly reconfigure virtually all auto-accompaniment-related panel settings with the touch of a single button.

- 1 Press the round One Touch Setting button to call up the One Touch Setting function.

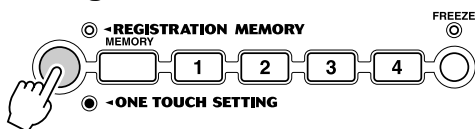

- 2 Press one of the [ONE TOUCH SETTING] buttons [1]-[4].

Steps #3 - #4 of “Using Auto Accompaniment (all tracks)” (page 33) can be set with just a single press of a [ONE TOUCH SETTING] button. In addition, various panel settings (such as voices, effects, etc.) that match the selected style can be instantly recalled with just a single button press (see below).

- 3 As soon as you play a chord with your left hand, the auto accompaniment starts.

For this example, play a C major chord (as shown below).

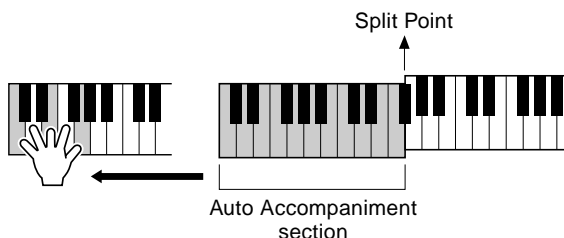

- 4 Stop the accompaniment.

NOTE

- You can also try changing the established One Touch Setting data, making your own original settings. To be able to recall your original settings anytime, save them using the Registration Memory function (page 54).
- When a User style (number 113-115) is selected, the One Touch Setting cannot be used.

One Touch Setting parameter list

The PSR-550 features four different One Touch Settings for each of the 112 auto accompaniment styles built into the instrument. Each has been specially programmed to match the selected style; each has the best suited voice (or combination of voices), digital effects and other settings for that style. Simply pressing one of the [ONE TOUCH SETTING] buttons lets you instantly reconfigure all relevant settings, conveniently allowing you to start playing in a desired style with all the appropriate sounds — without having to make each setting one by one.

- Part on/off (VOICE R1, R2) page 29
- Voice Change setting (VOICE R1, R2) page 75
- Mixer setting (VOICE R1, R2) page 76
- Auto accompaniment = ON page 33
- Synchro Start = ON* page 33
- HARMONY/ECHO on/off, type, volume, part page 50
- DSP on/off, type, return level and FAST/SLOW page 49
- Multi Pad bank number page 44
- Upper Octave setting page 119

* Set only when the accompaniment is not playing.

The Multi Pads

The PSR-550 Multi Pads can be used to play a number of short pre-recorded rhythmic and melodic sequences that can be used to add impact and variety to your keyboard performances. You can also record your own Multi Pad phrases as described in “Multi Pad Recording” on page 92.

Some pad phrases simply play back as programmed, while others are “chord match” types which, if the Chord Match function is turned on, are automatically transposed to match chords played using the PSR-550 auto accompaniment feature.

- Playing the Multi Pads page 43
- Chord Match page 43
- Selecting a Multi Pad Bank page 44
- Turning the Chord Match On/Off page 44

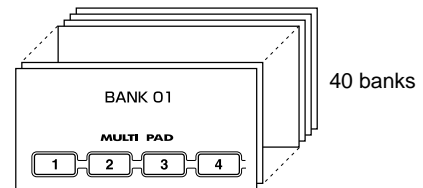

Playing the Multi Pads

Press any of the Multi Pads.

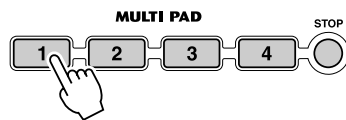

The corresponding phrase (in this case, for Pad 1) starts playing back in its entirety as soon as the pad is pressed. To stop playback in the middle of the phrase, press the [STOP] button.

NOTE

- Simply tap any of the Multi Pads at any time to play back the corresponding phrase at the currently set tempo.
- You can even play two, three or four Multi Pads at the same time.
- Pressing the pad during its playback will stop playing and begin playing from the top again.

Chord Match

- 1** Press the [STYLE] button.
- 2** Turn AUTO ACCOMPANIMENT on (page 33).
- 3** Play a chord with your left hand.

For this example, play an F major chord (as shown below).

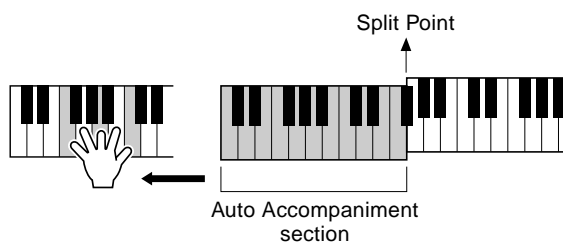

- 4** Press any of the Multi Pads.

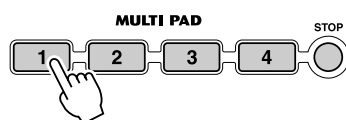

In this example, the phrase for Pad 1 will be transposed into F major before playing back. Try playing other chords and pressing the pads.

NOTE

- The chord match on/off status depends on the selected Multi Pad. Refer to the Multi Pad Bank list (page 45).

Selecting a Multi Pad Bank

1 Press the [FUNCTION] button.



2 Select "Multi Pad."

Use the **data dial**, the [+ / YES] button or the [- / NO] button.

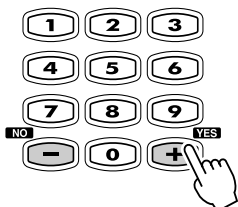
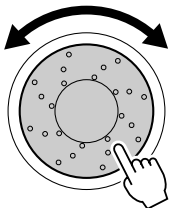

F1 Multi Pad

3 Press the [NEXT] button to display the MULTI PAD BANK screen.

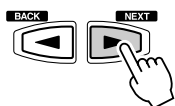

PBnk=01 Fanfare

4 Select a Bank.

Use the **data dial**, the [+ / YES] button, the [- / NO] button or the number buttons [1]-[0].

Turning Chord Match On/Off

1-3 Use the same operation as in "Selecting a Multi Pad Bank" above.

4 Press the [NEXT] button again.

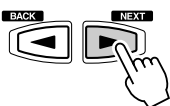

CdMatch Pad1=On

5 Select the desired PAD.

Use the [NEXT]/[BACK] button.

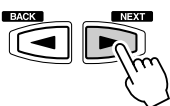

CdMatch Pad2=On

6 Turn the CHORD MATCH function on or off.

Use the **data dial**, the [+ / YES] button or the [- / NO] button.

NOTE

- The chord match function has no effect with pads that contain percussion phrases.
- The chord match on/off setting is restored to its original status whenever a preset Multi Pad Bank is selected.
- When the chord match on/off status of a user Multi Pad Bank (see above) is changed, the new status is recorded with the Multi Pad data.

● Multi Pad Bank List

No.	Bank name	Chord Match				Repeat			
		Pad1	Pad2	Pad3	Pad4	Pad1	Pad2	Pad3	Pad4
1	Fanfare	○	○	○	–	–	–	–	–
2	Crystal	○	○	○	○	–	–	–	–
3	Gothic_V	○	○	○	○	–	–	–	–
4	TechSyn1	○	○	○	○	○	○	○	○
5	TechSyn2	○	○	○	○	○	○	○	○
6	TechSyn3	○	○	–	–	○	○	○	○
7	TechSyn4	○	○	–	–	○	○	○	○
8	PianoSeq	○	○	○	○	–	–	–	–
9	OrcheHit	○	○	○	○	–	–	–	–
10	Traffic	–	–	–	–	–	–	–	–
11	Chirp	–	–	–	–	–	–	–	–
12	HorrorSE	–	–	–	–	–	–	–	–
13	Noises	–	–	–	–	–	–	–	–
14	WaterSE	–	–	–	–	–	–	–	–
15	AnalgKit	–	–	–	–	–	–	–	–
16	TechKit	–	–	–	–	–	–	–	–
17	RockKit	–	–	–	–	–	–	–	–
18	TomFlam	–	–	–	–	–	–	–	–
19	LatPerc1	–	–	–	–	–	–	–	–
20	LatPerc2	–	–	–	–	–	–	–	–
21	Timbales	–	–	–	–	–	–	–	–
22	ArabKit1	–	–	–	–	–	–	–	–
23	ArabKit2	–	–	–	–	–	–	–	–
24	Brassy1	○	○	○	○	–	–	–	–
25	Brassy2	○	○	○	○	–	–	–	–
26	Swingy	○	○	○	○	–	–	–	–
27	SynBrass	○	○	○	○	–	–	–	–
28	GtrPlay1	○	○	○	○	○	○	○	○
29	GtrPlay2	○	○	○	○	○	○	○	○
30	GtrPlay3	○	○	○	○	○	○	○	○
31	GtrPlay4	○	○	○	○	○	○	○	○
32	PianoMan	○	○	○	○	○	○	○	–
33	SalsaPno	○	○	○	○	○	○	○	○
34	SambaShw	–	–	–	–	○	○	○	○
35	Accrdion	○	○	○	○	–	–	–	–
36	Arpeggio	○	○	○	○	–	–	–	–
37	Classic	○	○	○	○	–	–	–	–
38	Twinkle	○	○	○	○	–	–	–	–
39	Xmas1	○	○	○	–	–	–	–	○
40	Xmas2	–	○	○	–	–	–	–	–

NOTE

- There are two types of Multi Pad data: some of the data will be played back once and stop when it reaches to the end. Others will be played back repeatedly until you press the [STOP] button.

○ : available

Digital Effects

With the digital effects built into the PSR-550 you can add ambiance and depth to your music in a variety of ways—such as adding reverb that makes you sound like you are playing in a concert hall or adding harmony notes for a full, rich sound.

● **Reverb** page 46

You can create a reverb effect that makes you sound like you are playing in places like a concert hall, or live in a club. Reverb is always set to on for the PSR-550. A total of 24 different reverb types are available.

NOTE

• For details about using Digital Effects (Reverb, Chorus, DSP) (page 132).

● **Chorus** page 48

You can add a chorus effect that makes your playing sound as though multiple parts were being played together at the same time. Chorus is always set to on for the PSR-550. A total of 16 different chorus types are available.

● **DSP** page 49

In addition to the Reverb and Chorus types, the PSR-550 has special DSP effects, that include additional effects usually used for a specific part, such as distortion and tremolo.

A total of 74 DSP types are available. The PSR-550 features one DSP system, which can be turned on or off by a panel button (page 49). The [FAST/SLOW] button can switch between variations of the DSP effect.

For example, this lets you change the rotating speed (fast/slow) of the rotary speaker effect.

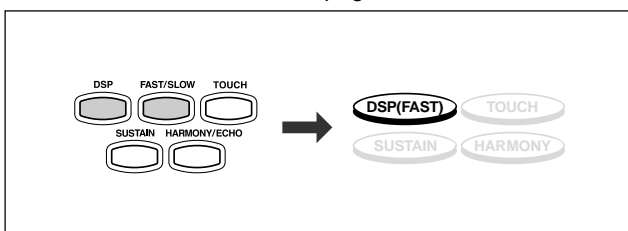

● **Harmony/Echo** page 50

You can add a variety of harmony notes to your playing in the right-hand section (page 29), as well as adding tremolo or other effects.



Reverb

Selecting a reverb type

1 Press the [FUNCTION] button.

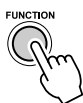

2 Select “Digital Effect”.

Use the **data dial**, the [+ / YES] button or the [- / NO] button.

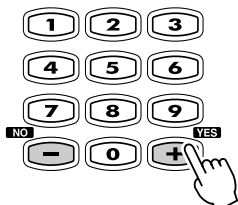
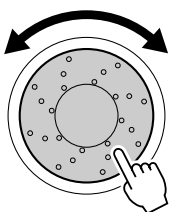

F3 DigitalEffect

3 Press the [NEXT] button to display the Digital Effect screen.

4 Select “Reverb”.

Use the **data dial**, the [+ / YES] button or the [- / NO] button.

D. Effect : Reverb

5 Press the [NEXT] button.

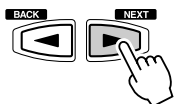

RevType=Hall1

6 Select a reverb type.

Use the **data dial**, the [+ / YES] button or the [- / NO] button.
Refer to the Reverb Type List (page 133).

NOTE

• When you select a different style, the appropriate reverb type will be selected accordingly.

7 Play the keyboard.

Try out some of the other reverb types as well.

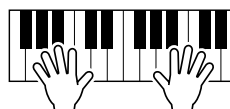

Adjust the depth of the reverb.

The two parameters below affect the depth of the reverb.

- **Reverb Depth (send level)** page 74
Sets the reverb depth for the specified voice or track, and thus the amount of reverb effect applied to that voice or track.
- **Reverb Return Level** see below
Sets the amount of reverb returned from the reverb effect stage, thus making it possible to adjust the degree of reverb effect applied to the overall sound.

8 Press the [NEXT] button.

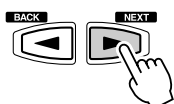

RevRetnLevel= 64

9 Adjust the reverb return level.

Use the **data dial**, the [+ / YES] button, the [- / NO] button or the number buttons [1]-[0].

The range is from 0 to 127. The higher the value, the greater the return level.

RevRetnLevel= 81

Chorus

Selecting a Chorus Type

1-3 Use the same operation as in “Reverb” (page 46).

4 Select “Chorus”.
Use the **data dial**, the [+/**YES**] button or the [-/**NO**] button.

D. Effect: Chorus

5 Press the [**NEXT**] button.

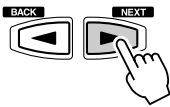

ChoType=Chorus2

6 Select a chorus type.
Use the **data dial**, the [+/**YES**] button or the [-/**NO**] button.
Refer to the Chorus Type List (page 133).

NOTE

- When you select a different style, the appropriate chorus type will be selected accordingly.

7 Play the keyboard.
Try out some of the other chorus types as well.



Adjust the depth of the chorus.

The two parameters below affect the depth of the chorus effect.

- **Chorus Depth (send level)** page 74
Sets the chorus depth for the specified voice or track, and thus the amount of chorus effect applied to that voice or track.
- **Chorus Return Level** see below
Sets the amount of chorus effect returned from the chorus effect stage, thus making it possible to adjust the degree of chorus effect applied to the overall sound.

8 Press the [**NEXT**] button.

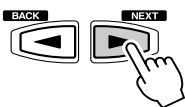

ChoRetnLevel= 64

9 Adjust the chorus return level.
Use the **data dial**, the [+/**YES**] button, the [-/**NO**] button or the number buttons [1]-[0].
The range is from 0 to 127. The higher the value, the greater the return level.

DSP

Applying the DSP effect

Press the [DSP] button.

The DSP icon will light up and the DSP effect will be turned on.

The effect will be applied when you play the R1, R2 and L voices from the keyboard.

In addition, when the [FAST/SLOW] button is pressed, the FAST icon lights up indicating that the variation of the DSP effect is selected. When the DSP effect type is Rotary Speaker or Tremolo, the speed of the modulation becomes fast.

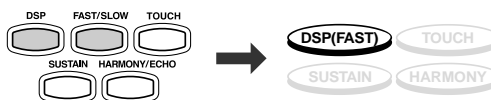

NOTE

• When the Voice Set function is ON (page 120), the DSP effect and FAST/SLOW settings may change according to the selected R1 panel voice.

Selecting a DSP Type

1 - 3 Use the same operation as in “Reverb” (page 46).

4 Select “Dsp”.

Use the data dial, the [+ / YES] button or the [- / NO] button.

5 Press the [NEXT] button.

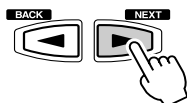

DspType=Stage?

6 Select a DSP type.

Use the data dial, the [+ / YES] button or the [- / NO] button. Refer to the DSP Type List (page 133).

7 Play the keyboard.

Try out some of the other DSP types as well.

NOTE

• When the selected DSP type is an Insertion Effect (pages 49, 133), the DSP effect applies only to the Voice R1.

Adjust the depth of the DSP.

The two parameters below affect the depth of the DSP effect.

- **DSP Depth (Send level)**..... page 74
Sets the DSP depth for the specified voice or track, and thus the amount of DSP effect applied to that voice or track.
- **DSP Return Level** see below
Sets the amount of DSP effect returned from the DSP effect stage, thus making it possible to adjust the degree of DSP effect applied to the overall sound.

NOTE

• If DSP Insertion Effect is selected (page 50), you won't be able to set the DSP Return Level.

8 Press the [NEXT] button.

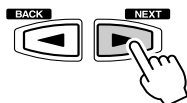

DspRetnLevel= 64

9 Adjust the DSP return level.

Use the data dial, the [+ / YES] button, the [- / NO] button or the number buttons [1]-[0].

The range is from 0 to 127. The higher the value, the greater the return level.

System Effects and Insertion Effects

The reverb, chorus and DSP effects are divided into two different types or methods of operation.

There are two types of digital effects: system effects and insertion effects.

- **System Effects**

Applies the effect to all of the parts input to the mixer. You can set the amount of effect applied with the depth and return level parameters. Reverb and chorus are both system effects.

- **Insertion Effects**

Applies the effect to only one designated part before inputting the signal to the mixer. You can effectively use the digital effects by applying the desired effect to the specific part.

With the insertion effects, only the DSP depth can be set.

The illustration below with the various audio components (instruments, effect devices and a mixer) represents the inner workings of the DSP effects of the PSR-550.

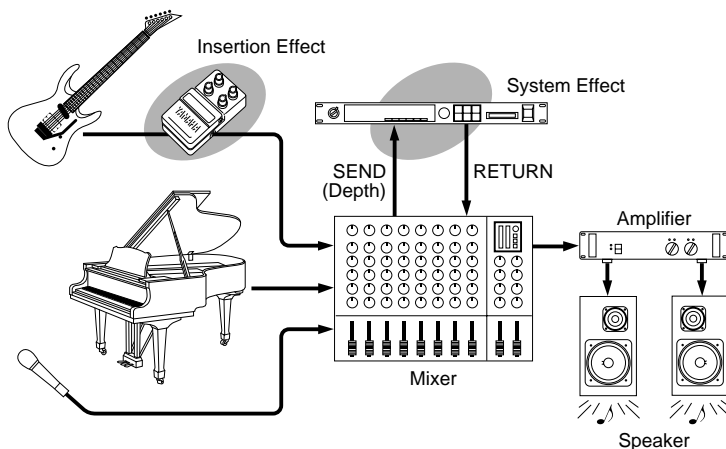

- Reverb All types function as system effects.
- Chorus All types function as system effects.
- DSP Depending on the selected type, this functions either as a system effect or an insertion effect.

Refer to “About Digital Effects” (page 132) and the Type List.

Harmony/Echo

Selecting a Harmony/Echo type

- 1 Press the [FUNCTION] button.

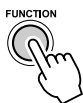

- 2 Select “DigitalEffect”.

Use the **data dial**, the [+ / YES] button or the [- / NO] button.

F3 DigitalEffect

- 3 Press the [NEXT] button to display the Digital Effect screen.

- 4 Select “Harmony”.**
Use the **data dial**, the [+/**YES**] button or the [-/**NO**] button.

D. Effect: Harmony

- 5 Press the [NEXT] button.**

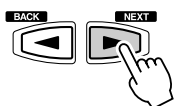

HType=Duet

- 6 Select a Harmony/Echo type.**
Use the **data dial**, the [+/**YES**] button or the [-/**NO**] button.
Refer to the Harmony/Echo Type List (page 134).

NOTE

- When the Voice Set function is ON (page 120), the Harmony/Echo type may change according to the selected R1 panel voice.

Applying the Harmony/Echo effect

- 1 Press the [STYLE] button.**
- 2 Turn AUTO ACCOMPANIMENT on (page 33).**
- 3 Play a chord with your left hand.**
For this example, play a C major chord.

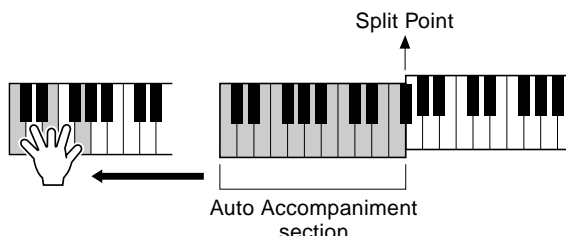

CHORD
#b dim6 (#119)
b513
mM 7augus4

- 4 Press the [HARMONY/ECHO] button.**



- 5 Play some notes in the right-hand range of the keyboard.**

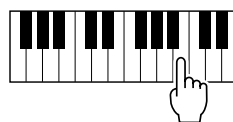

NOTE

- Harmony/Echo cannot be turned on when the Full Keyboard (page 40) is selected. Harmony/Echo will be automatically turned off if the Full Keyboard fingering mode is selected while the Harmony/Echo effect is on.

- **When a Harmony type (Duet through Strum) is selected**
This type automatically add one or more harmony notes to a single-note melody played in the right hand.
- **When an Echo type is selected**
An echo effect is applied to the note played on the keyboard at the currently set tempo.
Steps #1 - #3 above are unnecessary for this type.
- **When a Tremolo type is selected**
A tremolo effect is applied to the note played on the keyboard at the currently set tempo.
Steps #1 - #3 above are unnecessary for this type.
- **When a Trill type is selected**
Two notes held on the keyboard are played alternately at the currently set tempo.
Steps #1 - #3 above are unnecessary for this type.

Adjusting the Harmony/Echo volume

The volume of the Harmony/Echo sound in relation to the keyboard sound can be adjusted as follows:

- 1-4** Use the same operation as in “Selecting a Harmony/Echo Type” (page 50).

D. Effect: Harmony

- 5** Press the [NEXT] button to display the Type Selection screen.

- 6** Press the [NEXT] button to display the Harmony/Echo Volume screen.

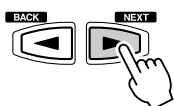

Harmony Vol =120

- 7** Adjust the Harmony/Echo volume.

Use the **data dial**, the [+ / YES] button, the [- / NO] button or the number buttons [1]-[0].

The volume range is from 0 (no sound) to 127 (maximum volume).

Harmony Vol =113

NOTE

- When the Voice Set function is on (page 120), the Harmony/Echo Volume may change according to the selected R1 panel voice.
- Changing the volume of the harmony sound may not produce audible effect for some R1 voices (ex. organ sounds) when you select Harmony types “Duet” through “Strum”.

Changing the Part for the Harmony/Echo effect

This allows you to select the part which is used for the Harmony/Echo effect.

- 1 - 4** Use the same operation as in “Selecting a Harmony/Echo Type” (page 50).

D. Effect: Harmony

- 5** Press the [NEXT] button to display the Type Selection screen.

- 6** Press the [NEXT] button to display the Harmony Volume screen.

- 7** Press the [NEXT] button to display the Harmony Part setting screen.

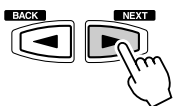

HarmoPart=Auto

- 8** Set the part.

Use the **data dial**, the [+ / YES] button or the [- / NO] button.

- Auto Harmony/Echo notes are automatically assigned to the R1 and R2 parts, in that order or priority.
- Right1 Harmony/Echo is only applied to the Voice R1.
If Voice R1 is off, there will be no Harmony/Echo effect.
- Right2 Harmony/Echo is only applied to the Voice R2.
If Voice R2 is off, there will be no Harmony/Echo effect.

NOTE

- When the Voice Set function is on (page 120), the Harmony/Echo part setting may change according to the selected R1 panel voice.

Registration Memory

Since the PSR-550 is such a sophisticated instrument with such a variety of controls and functions — voice, style, auto accompaniment and effect settings, just to name a few — the Registration Memory feature is one of the most convenient and powerful of the instrument. It allows you save virtually all panel settings to a Registration Memory setting, and then instantly recall your custom panel settings by pressing a single button.

Registration Memory provides up to 128 complete control-panel setups (32 banks, 4 setups each) that can be recalled instantly during your performance.

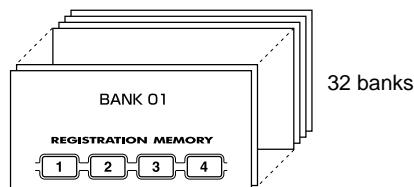

NOTE

- The PSR-550's initial Registration Memory [1]–[4] settings (when it shipped from the factory) are the same panel settings as when the STANDBY switch is first turned on.

- Registering the Panel Settings page 55
- Recalling the Registered Panel Settings page 55
- Selecting a Registration Bank page 56
- Naming the Registration Banks page 56

Data stored by the Registration Memory

■ VOICE PARAMETERS

- Part on/off (VOICE R1, R2, L) page 29
- Voice Change setting (VOICE R1, R2, L) page 75
- Mixer setting (VOICE R1, R2, L) page 76
- Touch Sensitivity page 120
- DSP on/off, FAST/SLOW on/off, DSP Type and Return Level page 49
- HARMONY/ECHO on/off, type, volume, part page 50
- TOUCH on/off page 120
- SUSTAIN on/off page 30
- Pitch Bend Range page 122
- Scale Tuning page 119
- Footswitch function page 121
- Transpose page 30
- Upper Octave setting page 119
- Direct Access setting page 122
- Backlight color setting page 122

NOTE

- Material recorded data is retained in memory even when the STANDBY switch is turned off if batteries are installed or an AC adaptor is connected (page 136). It is nevertheless a good idea to save important data to floppy disk so that you can keep them indefinitely and build up your own data library (page 60).

■ ACCOMPANIMENT PARAMETERS

- Auto Accompaniment on/off page 33
- Style number page 32
- Main A/B section page 34
- Tempo page 36
- Fingering mode page 38
- Split Point page 120
- Accompaniment Volume page 37
- Track on/off setting page 37
- Voice Change setting page 75
- Mixer setting page 75
- Multi Pad Bank number, Chord Match on/off page 43
- Reverb setting page 46
- Chorus setting page 48

Registration Memory data can be saved to and loaded from floppy disk as needed (page 57).

Registering the Panel Settings

- 1 Set up the panel controls as required.
- 2 Press the round Registration Memory button to call up the Registration Memory function.

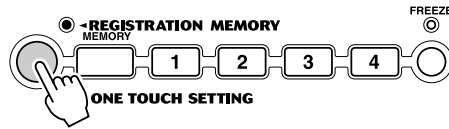

- 3 While holding the [MEMORY] button, press one of the REGISTRATION MEMORY buttons: [1] through [4].

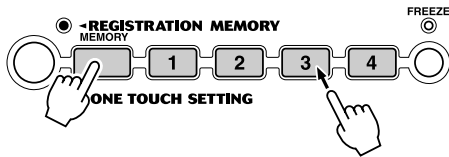

A “Regist Memorized” message briefly appears in the display, indicating that the panel settings have been memorized.

In this example, the panel settings are memorized to button number 3.

NOTE

- Any data that was previously recorded in the Registration Memory location you selected will be erased and replaced by the new settings.
- The Registration Memory contents will be retained even after turning the power off. See page 136 for details.

Recalling the Registered Panel Settings

- 1 Press one of the REGISTRATION MEMORY buttons: [1] through [4].

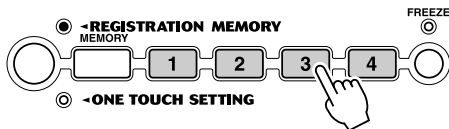

In this example, the panel settings memorized to button number 3 are recalled.

NOTE

- Registration data cannot be recalled when the One Touch Setting function is on.
- Some parameters cannot be recalled depending on the selected mode. For example, you cannot recall the Voice R2/L voices in the Style Record mode and Pad Record mode even if you press the Registration Memory buttons, since only the Voice R1 voice is used in those modes.

The Accompaniment Freeze function

When the FREEZE function is engaged, selecting a different Registration Memory setup will not change any of the accompaniment (all other parameters will change as programmed). This allows you to use the auto accompaniment and select different Registration Memory setups, without suddenly disturbing the flow of the accompaniment.

- 1 Press the [FREEZE] button.

The [FREEZE] lamp lights.

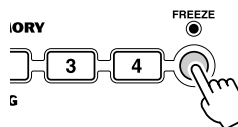

- 2 Press one of the REGISTRATION MEMORY buttons: [1] through [4].

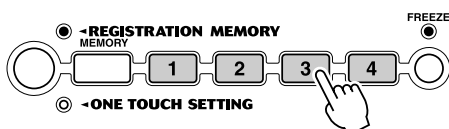

In this example, only the voice parameter settings memorized to button number 3 are recalled.

NOTE

- For details about Accompaniment parameters (page 54).
- The Freeze function will automatically be turned on when one of the following modes, Song, Style Record or Pad Record is engaged.

Selecting a Registration Bank

- 1 Press the [FUNCTION] button.



- 2 Select "Regist Memory".

Use the **data dial**, the [+ / YES] button or the [- / NO] button.

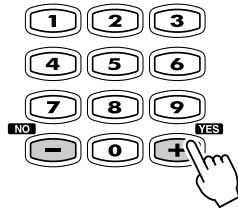
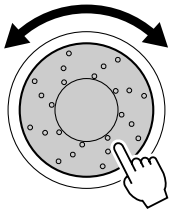

F2 Regist Memory

- 3 Press the [NEXT] button to display the Registration Memory Bank screen.

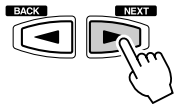

RBnk=01 Regist01

- 4 Select a bank.

Use the **data dial**, the [+ / YES] button, the [- / NO] button or the number buttons [1]-[0].

Naming the Registration Banks

- 1-3 Use the same operation as in "Selecting a Registration Bank" (see above).

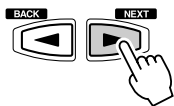

RBnk=01 Regist01

- 4 Press the [NEXT] button to display the Name screen.

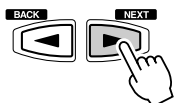

RegName=Regist01

Cursor

- 5 Enter the desired name for the bank.

Use the keyboard to enter the name (page 21).
Up to eight letters or characters can be used.

Disk Operations

Built into the PSR-550 is a disk drive. Simply insert a floppy disk and you've got access to a wide variety of convenient functions, such as recording and playback of User songs (page 78), as well as saving and loading of User styles (page 96), User pads (page 92) and Registration Memory data (page 54).

You can save any number of User styles, pads and registration data to floppy disks, create your own song libraries or find many other ways to make playing and using the PSR-550 more efficient.

- The PSR-550 is capable of playing back songs contained on the included data disk, as well as commercially available song data in the following formats, indicated by the corresponding logos (page 9):



You can play back song files collected on these disks using the voices defined in the GM standard.



You can play back songs using the XG format, an extension of the GM standard that allows for much higher sound quality.



You can play back song files collected on these disks using the voices defined in Yamaha's DOC format.

- The PSR-550 is compatible with style data contained on the included data disk, as well as commercially available disk styles in the following format, indicated by the corresponding logo (page 9):



You can load and play with the style files collected on these disks.

- You can record your own performances to User songs and play them back (page 78).

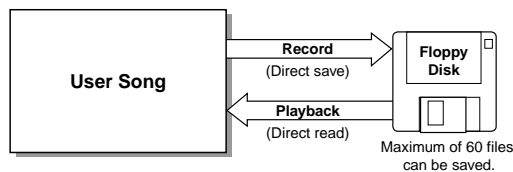

- The PSR-550 features special User style, User pad and Registration Memory functions. The data recorded with these functions can also be saved to disk individually or in any combination. Likewise, data (files) saved to disks can be loaded individually or in any combination to the PSR-550.

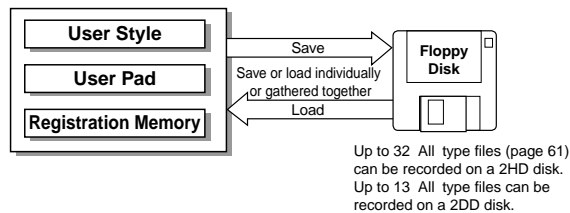

User data compatible with the PSR-550 is indicated in the chart below.

● **Data that can be Saved or Loaded with the PSR-550**

Data Type	Extension	Save	Load
User song (Standard MIDI format0)	.MID	—	—
User style (Style file format)	.USR	○	○
User pad	.USR	○	○
Registration Memory	.USR	○	○

- Other disk functions include:

- Format page 60
- Song Copy page 64
- Delete page 67

NOTE

- Refer to page 9 for more details on the logos.

NOTE

- It may not be possible to record the full 60 files to a disk, depending on the length of the recorded files.

NOTE

- The maximum number of files may vary according to the type and volume of the saved files (page 61).

NOTE

- When saving data, use a floppy disk formatted on the PSR-550.
- The three letters following the file name (after the period) are referred to as a file "extension". The extension indicates the type of file.
- Since the user songs are directly recorded to the disk as you play during recording and read from the disk during playback, the Save/Load functions are not available. The Copy and Delete File operations related to the user songs can be executed.

Using the Floppy Disk Drive (FDD) and Floppy Disks

Be sure to handle floppy disks and treat the disk drive with care. Follow the important precautions below.

Compatible Disk Type

3.5" 2DD and 2HD type floppy disks can be used.

Inserting/Ejecting Floppy Disks

- To insert a floppy disk into the disk drive:
 - Hold the disk so that the label of the disk is facing upward and the sliding shutter is facing forward, towards the disk slot.
- Carefully insert the disk into the slot, slowly pushing it all the way in until it clicks into place and the eject button pops out.

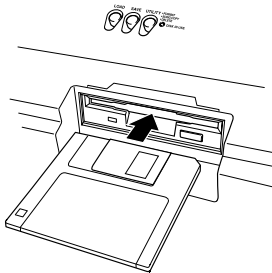

NOTE

- When the PSR-550 is turned on, the LED below the floppy disk slot will be lit indicating that the Disk Drive is ready to use.

- To eject a floppy disk:
 - Before ejecting the disk, be sure to confirm that the FDD is stopped (check if the DISK IN USE lamp is off). Press the eject button slowly as far as it will go; the disk will automatically pop out. When the disk is fully ejected, carefully remove it by hand.

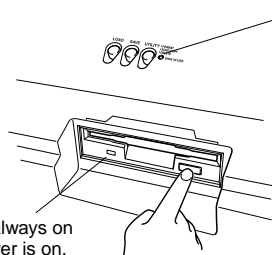

DISK IN USE
This lamp lights during disk read/write operations, such as when a disk has been inserted, during recording, playback, formatting, etc.

This lamp is always on when the power is on, regardless of the disk operation.

- If the eject button is pressed too quickly, or if it is not pressed in as far as it will go, the disk may not eject properly. The eject button may become stuck in a half-pressed position with the disk extending from the drive slot by only a few millimeters. If this happens, do not attempt to pull out the partially ejected disk, since using force in this situation can damage the disk drive mechanism or the floppy disk. To remove a partially ejected disk, try pressing the eject button once again or push the disk back into the slot and then repeat the eject procedure.
- Never attempt to remove the disk or turn the power off during recording, reading and playing back. Doing so can damage the disk and possibly the disk drive.
- Be sure to remove the floppy disk from the disk drive before turning off the power. A floppy disk left in the drive for extended periods can easily pick up dust and dirt that can cause data read and write errors.

Cleaning the Disk Drive Read/Write Head

- Clean the read/write head regularly. This instrument employs a precision magnetic read/write head which, after an extended period of use, will pick up a layer of magnetic particles from the disks used that will eventually cause read and write errors.
- To maintain the disk drive in optimum working order Yamaha recommends that you use a commercially-available dry-type head cleaning disk to clean the head about once a month. Ask your Yamaha dealer about the availability of proper head-cleaning disks.
- Never insert anything but floppy disks into the disk drive. Other objects may cause damage to the disk drive or floppy disks.

About the Floppy Disks

- To handle floppy disks with care:
 - Do not place heavy objects on a disk or bend or apply pressure to the disk in any way. Always keep floppy disks in their protective cases when they are not in use.
 - Do not expose the disk to direct sunlight, extremely high or low temperatures, or excessive humidity, dust or liquids.
 - Do not open the sliding shutter and touch the exposed surface of the floppy disk inside.
 - Do not expose the disk to magnetic fields, such as those produced by televisions, speakers, motors, etc., since magnetic fields can partially or completely erase data on the disk, rendering it unreadable.
 - Never use a floppy disk with a deformed shutter or housing.
 - Do not attach anything other than the provided labels to a floppy disk. Also make sure that labels are attached in the proper location.
- To protect your data (write-protect tab):
 - To prevent accidental erasure of important data, slide the disk's write-protect tab to the "protect" position (tab open).

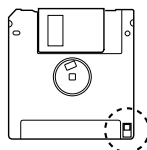

Write protect tab ON (locked or write protected)

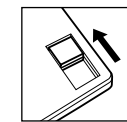
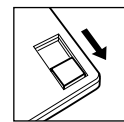

Write protect tab OFF (unlocked or write enabled)

- Data backup
 - For maximum data security Yamaha recommends that you keep two copies of important data on separate floppy disks. This gives you a backup if one disk is lost or damaged.

Included Data Disk

Disk song playback

1 Insert the included data disk into the disk drive.

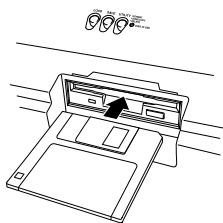

NOTE

- If a disk has already been inserted into the drive, press the [SONG] button to call up the Song display.

2 Select the desired song.

Use the **data dial**, the [+ / YES] button, the [- / NO] button or the number buttons [1]-[0].

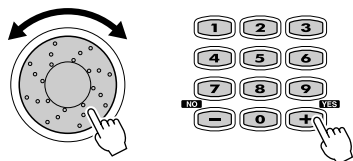

3 Press the [START/STOP] button to start the song.

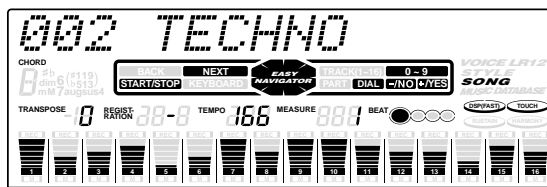
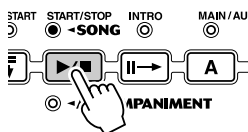

4 Press the [START/STOP] button again to stop the song.

For details, see “Song Playback” (page 68).

Format

Setting up commercially available floppy disks for use with PSR-550 is called formatting.

This function is useful for quickly deleting unnecessary files from an already formatted disk. Be careful when using this operation, since it automatically deletes all data on the disk.

NOTE

- After formatting, the capacity of a 2HD disk is 1 MB and that of a 2DD disk is 720 KB.

NOTE

- When the floppy disk's write-protect tab is set to ON (page 58) or the disk is a purposely "copy-protected" disk, an alert message appears indicating that the Format function is not possible.

CAUTION

- If data is already saved on the disk, be careful not to format it. If you format the disk, all the previously recorded data will be deleted.
- While formatting is in progress, never eject the disk or turn off the power to the PSR-550.
- If a disk that cannot be read by the PSR-550 is inserted into the disk drive, it will be treated the same as an unformatted floppy disk. Take care not to erase important data by accidentally formatting a disk.

1 Insert the floppy disk into the disk drive.

When a (new) blank disk or an incompatible disk is inserted "Unformatted Disk" will be displayed on the screen. In this case, press the [EXIT] button to show "Format OK?" and then simply follow the procedure 5 below.

2 Press the [UTILITY] button.

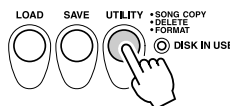

3 Select "Format".

Use the data dial, the [+ / YES] button or the [- / NO] button.

Utility:Format

4 Press the [NEXT] button to display the FORMAT operation screen.

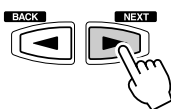

Format OK?

5 Execute the Format operation.

Press the [+ / YES] button to execute the Format operation.

Press the [- / NO] button to abort the Format operation.

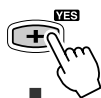

Formatting 49%

The Format operation is completed...

Completed

Save

You can save PSR-550 User styles, User pad (banks 37-40) and Registration Memory data (banks 01-16) to floppy disks.

1 Insert the floppy disk into the disk drive.

2 Press the [SAVE] button.

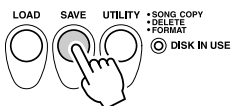

Sv Type:All

NOTE

- When the floppy disk's write-protect tab is set to ON (page 58) or the disk is a purposely "copy-protected" disk, an alert message appears indicating that the Save function is not possible.

3 Select the file type.

Use the **data dial**, the [+/**YES**] button or the [-/**NO**] button.
Refer to the file type list below:

All	Save all User Style (113-115), User Pad (bank 41-44), Registration Memory (bank 01-32) and all setup data into one single file.
Sty + Reg	Save all User Style (113-115) and Registration Memory (bank 01-32) data gathered together into one single file.
Style	Save all User Style (113-115) data gathered together into one single file.
Multi Pad	Save all User Pad (bank 41-44) data gathered together into one single file.
Regist	Save all Registration Memory (bank 01-32) data gathered together into one single file.

NOTE

- Although all User Style, User Pad and Registration Memory data can be saved together into one single file, the data can be recalled individually when loaded back into the PSR-550.

4 Press the [NEXT] button to display the FILE SELECT screen.

5 Select the destination file.

Use the **data dial**, the [+/**YES**] button or the [-/**NO**] button.
Select **NEW** when creating a new file.

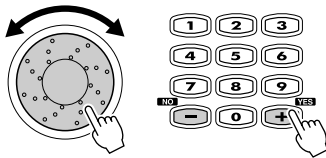

Sv =NEW

NOTE

- If you've selected a file that already contains data and you rename the file with the intent of overwriting the data, renaming the file will simply copy that data to the new file name and leave the original data and file name intact.

6 Press the [NEXT] button to display the Name screen.

7 Enter the file name directly from the keyboard (page 21).

Sv Name=UF_00002

CAUTION

- While data is being saved, never eject the floppy disk or turn off power to the PSR-550.

8 Press the [NEXT] button to display the Save operation screen.

Save OK?

NOTE

- If there isn't enough space on the disk, an alert message appears and you will not be able to save any data. You can delete unneeded files on the disk (page 67), or replace the disk with a new one and repeat the Save operation.
- If a write error occurs during a save operation, an alert message appears. If the error reoccurs after repeating the Save operation, there could be something wrong with the disk. Insert a different disk in the drive and repeat the Save operation.

9 Execute the Save operation.

Press the [+/**YES**] button to execute the Save operation.
Press the [-/**NO**] button to abort the Save operation.



Executing 45%

The Save operation is completed...

Completed

Load

After saving User style (107-109), User pad (banks 37-40) and Registration Memory (bank 01-32) data to a floppy disk, you can reload them into the PSR-550.

- 1 Insert the floppy disk into the disk drive.

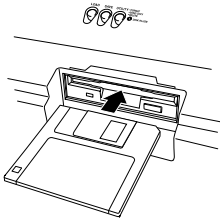

- 2 Press the [LOAD] button.

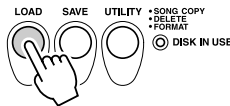

- 3 Select the file to be loaded.

Use the **data dial**, the [+ / YES] button or the [- / NO] button.

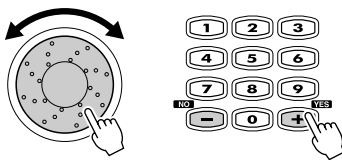

Ld =ABCD .USR

- 4 Press the [NEXT] button to display the Data Type Selection screen.

- 5 Select the file type (data type) to be loaded.

Use the **data dial**, the [+ / YES] button or the [- / NO] button.

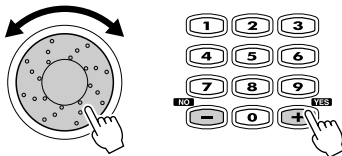

Ld Type: All

File types that can be loaded	
All	To Step 10
Sty + Reg	To Step 10
Style	To Step 6
Multi Pad	To Step 6
Regist	To Step 6

Please follow the steps as indicated in the chart above, since the actual operation differs depending on the selected file type.

6 Press the [NEXT] button.

```
Src=User8BeatPop
```

7 Select the data to be loaded.

Use the data dial, the [+ / YES] button or the [- / NO] button.

8 Press the [NEXT] button to display the destination selection screen.

9 Select the destination.

Use the data dial, the [+ / YES] button or the [- / NO] button.

```
Dst=User5Style1
```

10 Press the [NEXT] button to display the Load operation screen.

```
Load OK?
```

11 Execute the Load operation.

Press the [+ / YES] button to execute the Load operation.
Press the [- / NO] button to abort the Load operation.



```
Executing 45%
```



The Load Operation is completed...

```
Completed
```

CAUTION

- When data is loaded from a floppy disk to the PSR-550, the data already in the memory of the instrument will be replaced by the data on the disk. Save important data into a disk file before doing the Load operation.
- While data is loading, never eject the floppy disk or turn the power off.

NOTE

- An alert message may appear on the display, if a problem occurs that prevents the data from being loaded. (For example, the capacity of the PSR-550 [RAM] may be exceeded, something may be wrong with the floppy disk, or the data from the disk may be corrupted, etc.)

Song Copy

This operation allows you to make backup copies of your important Song data. Primarily, this will come in handy when you are recording and editing song data. For example, if you are quantizing the track of a song (page 86) — which makes permanent changes to the track — making a backup copy of the song allows you to restore the original song data in case you're not satisfied with the results of the quantization. Having a dedicated backup disk for every song you work on is a good idea. In this way, you can save a new copy of the song each time you make an important edit to it.

Copying song data from one floppy disk to another

Prepare a backup disk by formatting it. One file can be copied at a time. As shown in the illustration below, first copy the desired file on the disk to internal memory, then copy it to the destination disk.

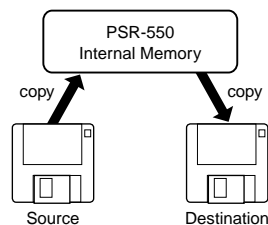

NOTE

- When the destination disk's write-protect tab is set to ON (page 58) or the disk is a purposely "copy-protected" disk, an alert message appears indicating that the Song Copy function is not possible.

If the quantity of data is large, it may be necessary for the data to be copied in parts.

1 Insert the disk to be copied (source disk) into the disk drive.

2 Press the [UTILITY] button.

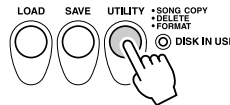

3 Select "SongCopy".

Use the **data dial**, the [+ / YES] button or the [- / NO] button.

```
Utility: SongCopy
```

4 Press the [NEXT] button to display the Copy Type selection screen.

5 Select "OtherFD".

Use the **data dial**, the [+ / YES] button or the [- / NO] button.

```
CopyType: OtherFD
```

6 Press the [NEXT] button to display the Song selection screen.

7 Select the source song file.

Use the data dial, the [+ / YES] button or the [- / NO] button.

Src=Song_01

8 Press the [NEXT] button to display the Name screen.

Dst=Song_01

Cursor

9 Enter the destination song name directly from the keyboard (page 21).

10 Press the [NEXT] button to display the Copy operation screen.

Copy OK?

11 Execute the Copy operation.

Press the [+ / YES] button to execute the Copy operation.
Press the [- / NO] button to abort the Copy operation.

NOTE

- If you insert a wrong disk, different from the source or destination disk, during the Copy operation, an alert message (page 137) will appear on the display.

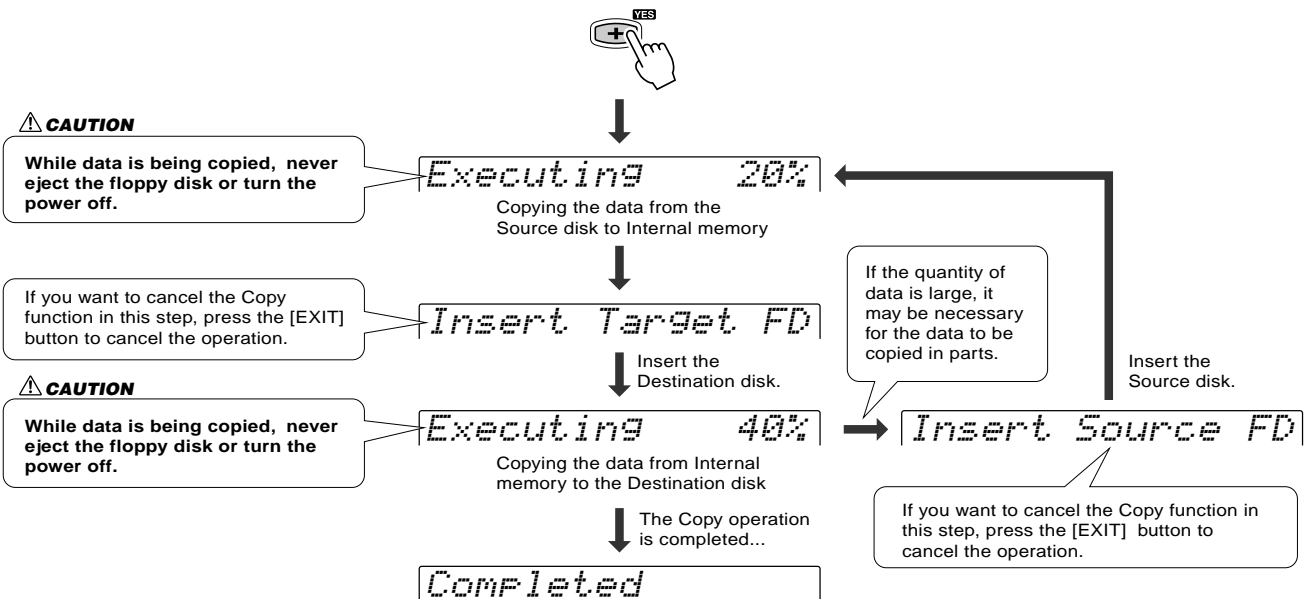

Copying data to another location on the same disk

1-4 Use the same operation as in “Copying data from one floppy disk to another” (page 64).

5 Select “Same FD”.

Use the **data dial**, the [+ / YES] button or the [- / NO] button.

CopyType: Same FD

6 Press the [NEXT] button to display the Song selection screen.

7 Select the song source file.

Use the **data dial**, the [+ / YES] button or the [- / NO] button.

Src=Song_01

8 Press the [NEXT] button to display the Name screen.

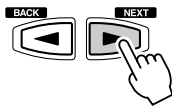

Dst=Song_01

Cursor

9 Enter the destination file name directly from the keyboard (page 21).

10 Press the [NEXT] button to display the Copy operation screen.

Copy OK?

11 Execute the Copy operation.

Press the [+ / YES] button to execute the Copy operation.

Press the [- / NO] button to abort the Copy operation.



Executing 49%

↓ The Copy Operation is completed...

Completed

CAUTION

- While data is being copied, never eject the floppy disk or turn the power off.

Delete

You can delete individual files (User songs, User styles, User pads or Registration Memory) from the floppy disk.

1 Insert the floppy disk into the disk drive.

2 Press the [UTILITY] button.

3 Select "Delete".

Use the **data dial**, the [+ / YES] button or the [- / NO] button.

```
Utility:Delete
```

4 Press the [NEXT] button to display the Delete screen.

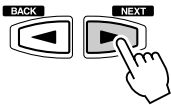

5 Select the file to be deleted.

Use the **data dial**, the [+ / YES] button or the [- / NO] button.

```
Del=ABCD .USR
```

6 Press the [NEXT] button to display the Delete operation screen.

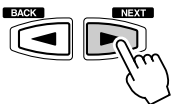

```
Delete OK?
```

7 Execute the Delete operation.

Press the [+ / YES] button to execute the Delete operation.
Press the [- / NO] button to abort the Delete operation.



```
Executing 49%
```

↓ The Delete Operation is completed...

```
Completed
```

NOTE

- When the floppy disk's write-protect tab is set to ON (page 58) or the disk is a purposely "copy-protected" disk, an alert message appears indicating that the Delete function is not possible.

CAUTION

- While the file is being deleted, never eject the floppy disk or turn the power off.

Disk Song Playback

You can playback a huge variety of songs on the PSR-550, including the preset demo songs, the songs on the included data disk, the User songs that you record to a floppy disk and songs on commercially available XG/GM song collection disks. Except for the preset demo songs, a floppy disk must be inserted in the disk drive to playback a song.

- The following disks are compatible for playback on the PSR-550 (including the data disk). Refer to page 9 for more details on the logos.



You can play back song files collected on these disks using the voices defined in the GM standard.



You can play back songs using the XG format, an extension of the GM standard that allows for much higher sound quality.



You can play back song files collected on these disks using the voices defined in Yamaha's DOC format.

- Disk songs can be played back in five different ways: page 69

- SINGLE
- SINGLE REPEAT
- ALL
- ALL REPEAT
- RANDOM

- Additional song playback functions:

- Song Track Muting page 70
- Tempo/Tap page 36
- Song Volume Control page 70
- Song Transpose page 73
- Playing from a Specified Measure page 71
- Repeat Play page 72

IMPORTANT

- Make sure to read the section "Using the Floppy Disk Drive (FDD) and Floppy Disks" on page 58.

NOTE

- The tempo setting of some commercially available disk songs is fixed. These songs are called "free-tempo software". When playing back free-tempo song data on the PSR-550, the Tempo display shows "- - -" and the beat display does not flash. Also, the measure number in the display does not match the actual measure number of playback, and only gives you an indication of how much of the song has played back.

Song Playback

1

Insert the disk that contains song data into the disk drive.

PSR-550 will automatically switch into Song mode.

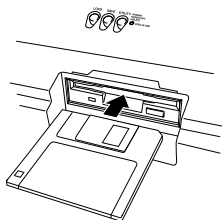

NOTE

- If a disk has already been inserted into the drive, press the [SONG] button to call up the Song display.
- Inserting a disk that does not contain song data will not automatically call up the Song display.

2

Select the desired song.

Use the **data dial**, the [+ / YES] button, the [- / NO] button or the number buttons [1]-[0].

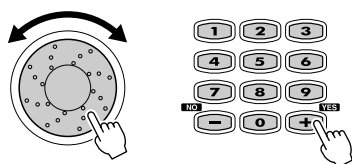

3

Press the [NEXT] button to display the Song Menu screen.

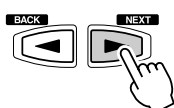

4 Select "PlayMode".

Use the **data dial**, the [+/**YES**] button or the [-/**NO**] button.

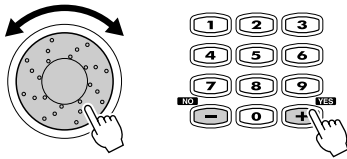

Sn@Menu: PlayMode

5 Press the [**NEXT**] button to display the Song Play Mode screen.

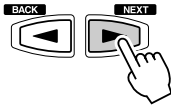

PlayMd=Single

6 Select the desired Play mode.

Use the **data dial**, the [+/**YES**] button or the [-/**NO**] button.

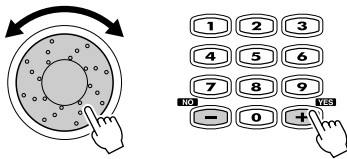

PlayMd=SglRepeat

- Single Play through the selected song, then stop.
- SglRepeat (Single Repeat) .. Play through the selected song repeatedly.
- All Continue playback through all the songs on the floppy disk.
- All Repeat Continue playback through all the songs on the floppy disk repeatedly.
- Random Continue playback through all the songs at random.

7 Press the [**START/STOP**] button to start the song.

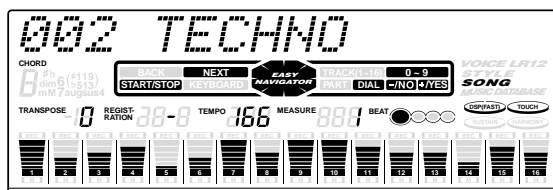
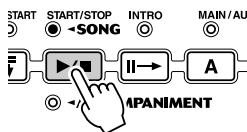

8 Press the [**START/STOP**] button again to stop the song.

Song Track Muting

- 1 Press the [START/STOP] button to start the song.
- 2 Press one of the TRACK buttons below the display.
The [M] icon will appear and the selected track will be muted.

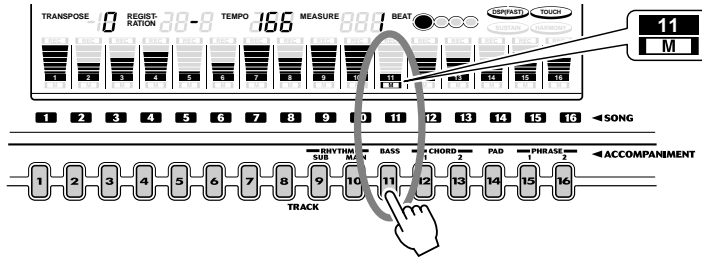

Pressing the same track button again enables output of the playback sound.

- 3 Press the [START/STOP] button again to stop the song.

Song Volume Control

- 1 Press the [START/STOP] to start the song.
- 2 Press the [ACMP/SONG VOLUME] button.



NOTE

- The volume of the keyboard-played voice(s) is not affected by this operation.

- 3 Adjust the Song Volume.

Use the data dial, the [+ / YES] button, the [- / NO] button or the number buttons [1]-[0].

The range is from 0 to 127.

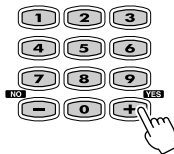
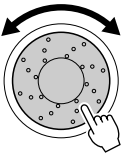

- 4 Press the [START/STOP] button again to stop the song.

Playing from a Specified Measure

- 1 Press the [SONG] button.
- 2 Press the [NEXT] button to display the Song Menu screen.
- 3 Select "Measure".
Use the data dial, the [+ / YES] button or the [- / NO] button.

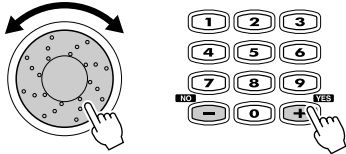

Sn@Menu# Measure

- 4 Press the [NEXT] button to display the Song Start Measure screen.

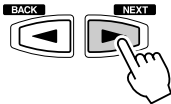

StartMeasure= 1

- 5 Specify the measure from which to begin playback.
Use the data dial, the [+ / YES] button, the [- / NO] button or the number buttons [1]-[0].

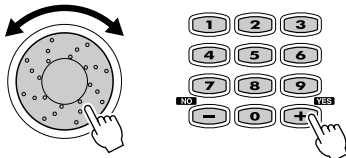

StartMeasure= 12

- 6 Press the [START/STOP] to start the song from the specified measure.

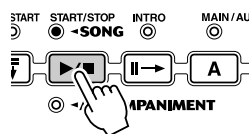

- 7 Press the [START/STOP] button again to stop the song.

Repeat Play (A-B Repeat)

- 1 Press the [SONG] button.
- 2 Press the [NEXT] button to display the Song Menu screen.
- 3 Select "AbRepeat".
Use the data dial, the [+ / YES] button or the [- / NO] button.

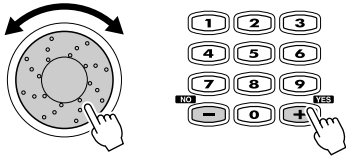

SngMenu: AbRepeat

- 4 Press the [NEXT] to display the Repeat screen.

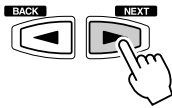

A-B Repeat =Off

- 5 Press the [START/STOP] button to start the song.

- 6 Press the [MAIN A] button or the [+ / YES] button at the starting point (A) to be repeated.

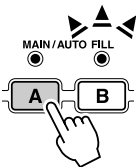

A-B Repeat =A-

NOTE

• If only the "A" repeat point is specified, repeat playback will occur between the "A" point and the end of the song.

- 7 Press the [MAIN B] button or the [+ / YES] button at the ending point (B) to be repeated.

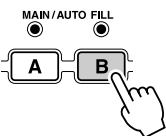

A-B Repeat =A-B

Repeat playback is now set, and the selected section automatically repeats indefinitely (until disabled or stopped in the steps below).

- 8 To cancel the repeat function and continue song playback, press the [MAIN A] button again, or press the [- / NO] button.

- 9 Press the [START/STOP] button to stop the song.

NOTE

• Repeat playback will be cancelled if a different song is selected.

Song Transpose

- 1 Press the [SONG] button.
- 2 Press the [NEXT] button to display the Song Menu screen.
- 3 Select "S.Trans".

Use the **data dial**, the [+ / YES] button or the [- / NO] button.

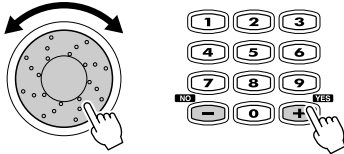

SngMenu# S. Trans

NOTE

- This operation does not affect the pitch of the keyboard-played voice(s)
- Changes made to the transpose setting (on page 30) affect the entire sound of the PSR-550, including the song transpose setting.
- Enabling the record mode to record a User song automatically resets the song transpose setting to "0".

- 4 Press the [NEXT] button to display the Song Transpose screen.

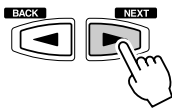

SongTranspose= 0

- 5 Set the Transpose value.

Use the **data dial**, the [+ / YES] button, the [- / NO] button or the number buttons [1]-[0].

The transpose range is from -12 to +12. Each step corresponds to one semitone, allowing a maximum upward or downward transposition of one octave. A setting of "0" produces normal pitch.

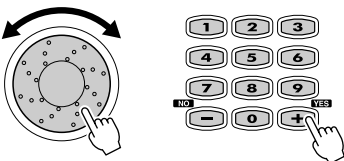

SongTranspose= 4

NOTE

- Minus values can be entered by using the number buttons while holding the [-] button.

- 6 Press the [START/STOP] to start the song.
- 7 Press the [START/STOP] button again to stop the song.

NOTE

- Steps #1 through #5 can be executed during playback.

Part Settings

In addition to the keyboard-played voices, the PSR-550 features many different instrumental “parts,” included with the auto accompaniment, and song playback.

● Style mode

	Part
Keyboard	VOICE R1
	VOICE R2
	VOICE L
Auto Accompaniment	RHYTHM SUB
	RHYTHM MAIN
	BASS
	CHORD1
	CHORD2
	PAD
	PHRASE1
	PHRASE2

● Song mode

	Part
Keyboard	VOICE R1
	VOICE R2
	VOICE L
Song	TRACK1
	TRACK2
	TRACK3
	TRACK4
	:
	TRACK15
	TRACK16

Use the following functions to change the settings for each part:

● Voice Change page 75

This lets you change the voice for each part.

● Mixer page 76

This lets you change the following settings for each part:

- Volume
Determines the volume of the specified voice or track.
- Octave
Shifts the pitch of the specified voice or track up or down by one or two octaves.
A setting of “0” produces normal pitch.
- Pan
Positions the sound of the specified voice or track from left to right in the stereo sound field. “-7” is full left, “7” is full right, “0” is center, and all other settings are corresponding positions in between.
- Reverb depth
Sets the reverb depth for the specified voice or track, and thus the amount of reverb effect applied to that voice or track.
- Chorus depth
Sets the chorus depth for the specified voice or track, and thus the amount of chorus effect applied to that voice or track.
- DSP depth
Sets the DSP depth for the specified voice or track, and thus the amount of DSP effect applied to that voice or track.

The parameters which can be set for each part are shown in the chart below.

● Parameters

Parameter	Voice R1, R2, L	Style	Song	Range	Function
Voice number	O	O	O	Refer to the Voice List (page 123)	Voice Change
Volume	O	O	O	0 – 127	Mixer
Octave	O	–	O	-2 – 2	Mixer
Pan	O	O	O	-64 – 63	Mixer
Reverb depth	O	O	O	0 – 127	Mixer
Chorus depth	O	O	O	0 – 127	Mixer
DSP depth	O	O	O	0 – 127	Mixer

O : available

NOTE

● **Voice R1, R2, L**

- When one of the DSP types belonging to the Insertion Effect (page 50) is selected, the effect will be exclusively applied to the Voice R1 and not to the Voice R2/L. Therefore the DSP depth for the Voice R2/L cannot be changed. Also, the DSP depth for the Voice R1 cannot be altered depending on the selected Insertion Effect type.
- Save any part settings you want to keep to the PSR-550 Registration Memory (page 54). The voice part settings are temporary and will be lost if the power is turned off, a different R1 panel voice is selected while the Voice Set function (page 120) is on, or a Registration Memory is recalled.

● **Song**

- Make sure to first select the appropriate song for which you wish to set the part before calling up the relevant display.
- Any part settings made for the song will be lost if you turn off the power, select another song, or select the Style mode (after finishing the part settings). To prevent this, make sure to select the Recording mode and save the song data to disk (page 78).

● **Auto Accompaniment**

- Only drum kit voices (page 31) can be selected for the RHYTHM MAIN track.
- When using auto accompaniment part settings for the RHYTHM SUB track, any of the voices can be selected but no chord changes will occur when using Auto Accompaniment.
- Make sure to first select the appropriate style for which you wish to set the part before calling up the relevant display.
- Auto accompaniment part settings can even be set while an accompaniment is playing.
- Auto accompaniment part settings affects all sections of the selected style.
- Save any part settings you want to keep to the PSR-550 Registration Memory (page 54). The Auto accompaniment part settings are temporary and will be lost if the power is turned off, a different style is selected while the Voice Set function (page 120) is on, or a Registration Memory is recalled.

Voice Change

In addition to being able to change the voices played from the keyboard (R1, R2, L), you can also change the voices for each track of the auto accompaniment and songs.

1

Press the [VOICE CHANGE] button.

The [VOICE CHANGE] lamp lights.



2

Select the part for which you want to change voices.

Parts can be selected from the following buttons (depending on the selected mode: Style or Song):

- Voice PART ON/OFF [VOICE R1], [VOICE R2], [VOICE L] buttons
- Accompaniment track [TRACK9]-[TRACK16] buttons (Style mode)
- Song track [TRACK1]-[TRACK16] button (Song mode)

3

Select a voice.

Use the **data dial**, the [+ / YES] button, the [- / NO] button or the number buttons [1]-[0].

Refer to the Voice List (page 123).



4

Repeat steps #2 and #3 as often as needed for other parts/tracks.

5

Press the [EXIT] button to exit from the Voice Change screen.

Mixer

1 Press the [MIXER] button so that its indicator lights.

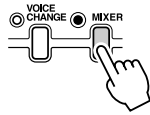

2 Select the part for which you want to adjust the volume setting or parameters.

Parts can be selected from the following buttons (depending on the selected mode: Style or Song):

- Voice PART ON/OFF [VOICE R1], [VOICE R2], [VOICE L] buttons
- Accompaniment track [TRACK9] - [TRACK16] buttons (Style mode)
- Song track [TRACK1] - [TRACK16] button (Song mode)

● **Style mode**

PART ON/OFF [VOICE R1] Voice R1
Volume R1 =120

PART ON/OFF [VOICE R2] Voice R2
Volume R2 =120

PART ON/OFF [VOICE L] Voice L
Volume L =120

[TRACK 9] Rhythm sub
Volume RhS=120

[TRACK 10] Rhythm main
Volume RhM=120

[TRACK 11] Bass
Volume Bas=120

[TRACK 12] Chord 1
Volume Cd1=120

[TRACK 13] Chord 2
Volume Cd2=120

[TRACK 14] Pad
Volume Pad=120

[TRACK 15] Phrase 1
Volume Ph1=120

[TRACK 16] Phrase 2
Volume Ph2=120

● **Song mode**

PART ON/OFF [VOICE R1] Voice R1
Volume R1 =120

PART ON/OFF [VOICE R2] Voice R2
Volume R2 =120

PART ON/OFF [VOICE L] Voice L
Volume L =120

[TRACK 1] Song track 1
Volume T01=120

[TRACK 2] Song track 2
Volume T02=120

•
•
•
•
•
•
•
•
•
•
•

[TRACK 16] Song track 16
Volume T16=120

3 Select the desired parameter by pressing the [NEXT]/[BACK] button.

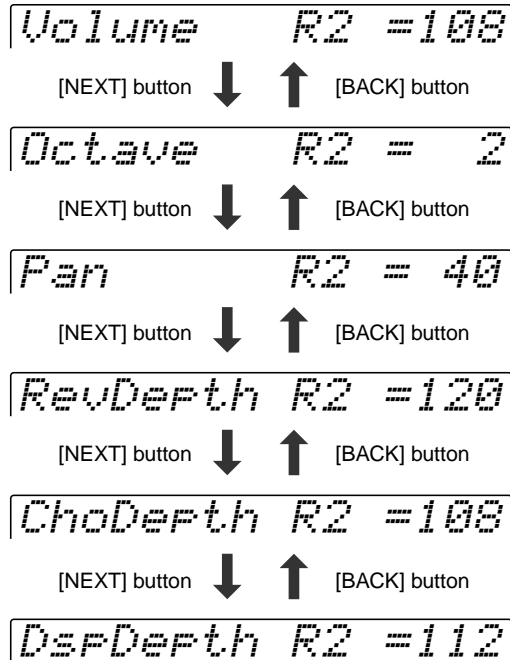

NOTE

- The Octave parameter of the style tracks cannot be edited.
- Minus settings for the Octave and Pan parameters can be directly entered by pressing the appropriate number button while holding the [-/NO] button.

The order of Steps 2 and 3 here can be reversed; you can also select the part after selecting the parameter. (In step #2 above, the Volume parameter is shown as an example; however, any of the other parameters shown in step #3 can be selected.)

4 Adjust the volume or parameters.

Use the data dial, the [+ / YES] button or the [- / NO] button.

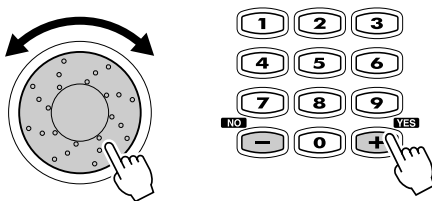

5 Repeat steps 2 to 4, as necessary.

6 Press the [EXIT] button to exit from the Mixer.

Song Recording

With the powerful and easy-to-use song recording features, you can record your own keyboard performances to a floppy disk as a User song, and create your own complete, fully orchestrated compositions.

Each User song lets you record up to sixteen independent tracks. These include not only the voices for the keyboard performance (R1, R2, L), but also the auto accompaniment parts.

NOTE

- User Songs are recorded on floppy disks. They cannot be recorded unless a floppy disk is inserted into the disk drive.

The PSR-550 provides two different ways to record: Quick Recording and Multi Track Recording. In addition, comprehensive editing functions let you “fine tune” the recorded song data.

- **Quick Recording** page 80
With this method, you can quickly and easily record a song, without having to make detailed settings.
- **Multi Track Recording** page 82
With this method, you can record up to sixteen tracks independently, and even re-record parts that have been previously recorded.
 - **Punch In/Out** page 84
This function allows you to selectively re-record a portion of a song track (the measures between the specified punch-in and punch-out points).
 - **Start Measure** page 84
This determines the measure at which recording starts. Set this when you desire to start the recording in the middle of the song when re-recording. Keep in mind that all previously recorded data from the starting measure is replaced.
- **Editing** page 86
The four editing features below allow you to edit already recorded song data.
 - **Quantize** page 86
This function aligns the timing of the recorded note data to a specified value.
 - **Editing Setup Data** page 88
This function allows you to change a variety of non-note settings.
 - **Naming User Songs** page 90
This function assigns a twelve-letter name to a recorded song.
 - **Clearing User Song Data** page 91
This function lets you delete song data, either a specified part or the entire song.

After finishing your recording of a User song, you can play it back in the same way as one of the disk songs.

■ Data that can be recorded to User songs

- **Tempo** page 36
- **Time signature** page 16
- **Accompaniment style number** page 32
- **Section changes and their timing** page 34
- **Chord changes and their timing** page 33
- **Accompaniment volume** page 37
- **Note on/off (key press and release)** page 107
- **Velocity (strength of key press)** page 107
- **Pitch bend, pitch bend range** pages 30, 122
- **Footswitch on/off** page 121
- **Voice Change settings** page 75
- **Mixer settings** page 76
- **Reverb type and settings** page 46
- **Chorus type and settings** page 48
- **DSP (including FAST/SLOW) on/off and type** page 49
- **Harmony/Echo on/off and type** page 50
- **Scale tuning** page 119
- **Sustain on/off** page 30

NOTE

- Songs recorded by the PSR-550 are saved as SMF (format 0) files. See page 109 for information on the SMF (format 0) format.

NOTE

- Being able to record note on/off and velocity means being able to record forte or piano, crescendo or diminuendo, and other subtle elements of expression from the keyboard as you play them.
- Note ON (key press), note OFF (key release), and velocity (strength of key press) are MIDI data events (playing information) (page 107).

The maximum amount of song memory is 65,000 notes for 2DD disks and 130,000 notes for 2HD disks.

■ User Song Tracks

The tracks which can be recorded to the User songs are organized as shown in the chart below.

Track	Other Parts that can be set	Default Part
1	VOICE R1, R2, L, Accompaniment Style track	VOICE R1
2	VOICE R1, R2, L, Accompaniment Style track	VOICE R2
3	VOICE R1, R2, L, Accompaniment Style track	VOICE L
4	VOICE R1, R2, L, Accompaniment Style track	VOICE R1
5	VOICE R1, R2, L, Accompaniment Style track	VOICE R1
6	VOICE R1, R2, L, Accompaniment Style track	VOICE R1
7	VOICE R1, R2, L, Accompaniment Style track	VOICE R1
8	VOICE R1, R2, L, Accompaniment Style track	VOICE R1
9	VOICE R1, R2, L, Accompaniment Style track	Accompaniment Style RHYTHM SUB
10	VOICE R1, R2, L, Accompaniment Style track	Accompaniment Style RHYTHM MAIN
11	VOICE R1, R2, L, Accompaniment Style track	Accompaniment Style BASS
12	VOICE R1, R2, L, Accompaniment Style track	Accompaniment Style CHORD1
13	VOICE R1, R2, L, Accompaniment Style track	Accompaniment Style CHORD2
14	VOICE R1, R2, L, Accompaniment Style track	Accompaniment Style PAD
15	VOICE R1, R2, L, Accompaniment Style track	Accompaniment Style PHRASE1
16	VOICE R1, R2, L, Accompaniment Style track	Accompaniment Style PHRASE2

The PSR-550 provides two different ways to record: Quick Recording and Multi Track Recording.

● About Multi Track Recording

In Multi Track Recording, you determine the track assignments (as shown above) before recording. Several tracks can be recorded simultaneously. In addition to being able to record to empty tracks, you can also re-record tracks that already contain recorded data.

● About Quick Recording

In Quick Recording, you can quickly record without having to worry about the track assignments above. Quick Recording automatically makes track assignments according to the simple rules below.

- When Record method is set to "Melody"
Your keyboard performances (VOICE R1, R2, L) are recorded to tracks 1 - 3.
- When Record method is set to "Acmp"
The auto accompaniment parts are recorded to tracks 9 - 16.
- When Record method is set to "Melody + Acmp"
Your keyboard performances (VOICE R1 and R2) are recorded to tracks 1 - 2, and the auto accompaniment parts are recorded to tracks 9 - 16.

The Quick Recording method is different from the Multi Track Recording method; however, for both of them, the recorded data is recorded on tracks 1–16.

If you wish to re-record a User song that was originally recorded by the Quick Recording method, use Multi Track Recording.

NOTE

The following notes and cautions are important points for you to keep in mind as you record.

- Using the Metronome function (page 118) can make your recording sessions much more efficient.
- Using Registration Memory (page 54) can make your recording sessions much more efficient, since various settings (such as voices, etc.) can be recalled by a single button press. When the record mode is engaged, the Registration Memory Freeze function will be turned on (it cannot be turned off while the record mode is engaged).
- When the record mode is engaged, the Synchro Stop function will be turned off (it cannot be turned on while the record mode is engaged).
- Whenever you record, any previously recorded material in the same track will be erased.
- Song files on commercially available disks which are not write-protected can be selected and recorded to (edited) on the PSR-550. If the song data is of a different format from that of the PSR-550 User songs, the display prompts you to convert the song data. By pressing the [+ / YES] button, you can convert the song data to the PSR-550 format (compatible with the PSR-550). Once the conversion operation is finished, the PSR-550 returns to record standby, allowing you to record.
- If the disk memory becomes full while recording, an alert message will appear on the display and recording will stop.
- Be careful to avoid turning off the power or unplugging the AC adaptor from the outlet during recording, since this will result in the loss of recorded data.

Quick Recording

1 Insert the floppy disk into the disk drive.

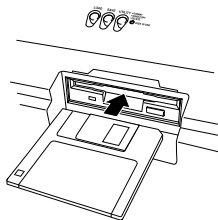

2 Press the [RECORD] button to engage the Record mode.



3 Select "Song".

Use the **data dial**, the [+ / YES] button or the [- / NO] button.

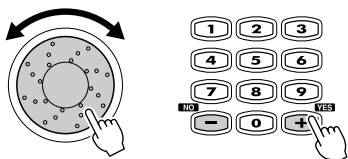

RecMenu# Song

4 Press the [NEXT] button.

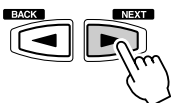

001 New Song

5 Press the [NEXT] button again to display the RecMode screen.

6 Select "QuickRec".

Use the **data dial**, the [+ / YES] button or the [- / NO] button.

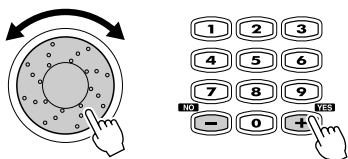

SongRec# QuickRec

7 Press the [NEXT] button.

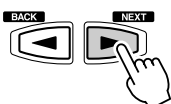

Rec Tr =Melody

8 Select a Record method.

Use the **data dial**, the [+ / YES] button or the [- / NO] button.

- Melody This records your keyboard performance (Voices R1/R2/L) without the auto accompaniment.
- Acmp This records only the auto accompaniment. When this is selected, the auto accompaniment is automatically set to on.
- Mel + Acmp This records your keyboard performance (Voices R1/R2) along with the auto accompaniment. When this is selected, auto accompaniment is automatically set to on.

9 Press the [NEXT] button to display the Record ready screen.

The beat indicator dots will flash at the currently set tempo, indicating that the record ready (Synchro Start) mode is engaged.



10 Start recording.

- If you've selected [Melody] or [Mel + Acmp] in step #8 above, recording starts as soon as you play a key.
- If you've selected [Acmp] in step #8 above, the auto accompaniment and recording start simultaneously as soon as a chord is played in the auto accompaniment section of the keyboard (the left side of the split point).
- Recording can also be started by pressing the [START/STOP] button.

NOTE

- Auto accompaniment cannot be turned on or off during recording.



11 Stop recording.

- If you've selected [Melody] in step #8 above, press the [START/STOP] button.
- If you've selected [Acmp] or [Mel + Acmp] in step #8 above, press the [START/STOP] button or the [ENDING] button. If you press the [ENDING] button while recording the auto accompaniment track, recording will stop automatically after the ending section has finished.



12 Select whether to save the newly recorded data to disk or not.

- To cancel the save operation (for example, when you wish to redo the recording), press the [-/NO] button and re-record starting with step #8 above, after the display returns to the Track selection screen.
- To save the data to disk, press the [+/YES] button.

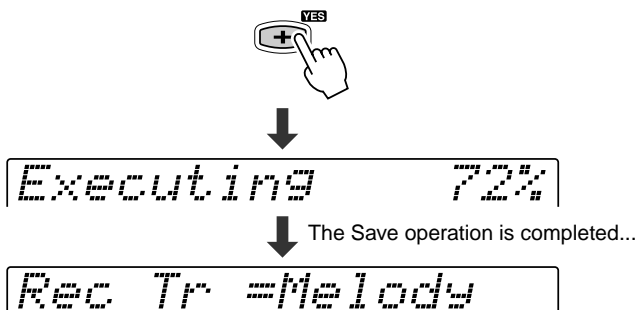

13 Press the [RECORD] button to exit from the Record mode.



CAUTION

- While the file is being saved, never eject the floppy disk or turn the power off.

Multi Track Recording

1-3 Use the same operation as in “Quick Recording” (page 80).

4 Press the [NEXT] button to display the Song selection screen.

001 New Song

5 Press the [NEXT] button again to display the RecMode screen.

6 Select “MultiRec”.

Use the data dial, the [+ / YES] button or the [- / NO] button.

SongRec: MultiRec

7 Press the [NEXT] button three times to display the PART setting screen.

RecPart T01 =R1

8 Select the desired track and part for recording.

1) Select a track.

Press one of the [TRACK1]-[TRACK16] buttons.

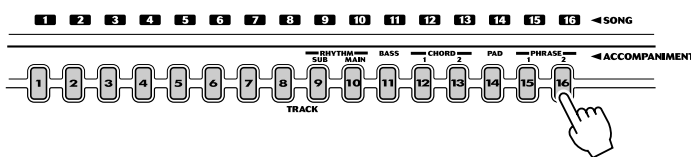

2) Select a part.

Use the data dial, the [+ / YES] button or the [- / NO] button.



[NEXT] button ↓ ↑ [BACK] button

3) Set the desired track to “Rec”.

Press the [NEXT] button and use the data dial, the [+ / YES] button or the [- / NO] button.



NOTE

- For information on the punch in and start measure functions (page 84).

NOTE

- For information on track assignments (page 79).
- To record auto accompaniment data, set the [ACMP] button to ON.
- The same part cannot be set to more than one track for recording.

- Make all necessary settings to each track by repeating steps 1) through 3) above.

9 Press the [NEXT] button to display the Rehearsal screen.

Voices and styles can be set from this display. After completing the desired settings, press the [EXIT] button to return to this display.



10 Press the [NEXT] button to display the Record Ready screen.

The beat indicator dots will flash at the currently set tempo, indicating that the record ready (Synchro Start) mode is engaged.



11 Start recording.

- Recording starts as soon as you play a key on the keyboard.
- If you enabled the auto accompaniment track for recording (in steps #8 above), recording starts as soon as you play a chord in the auto accompaniment section of the keyboard (the left side of the split point).
- Recording can also be started by pressing the [START/STOP] button.

NOTE

- Auto accompaniment cannot be turned on or off during recording.

12 Stop recording.

- If you did not enable the auto accompaniment track for recording (in steps #8 above), press the [START/STOP] button.
- If you enabled the auto accompaniment track for recording (in steps #8 above), press the [START/STOP] button or the [ENDING] button. If you press the [ENDING] button while recording the auto accompaniment track, recording will stop automatically after the ending section has finished.



13 Save the recorded data to the disk.

- To cancel the save operation (for example, when you wish to redo the recording), press the [-/NO] button and re-record starting with step #8 above, after the display returns to the Track setting screen.
- To save the data to disk, press the [+ /YES] button.

CAUTION

- While the file is being saved, never eject the floppy disk or turn the power off.

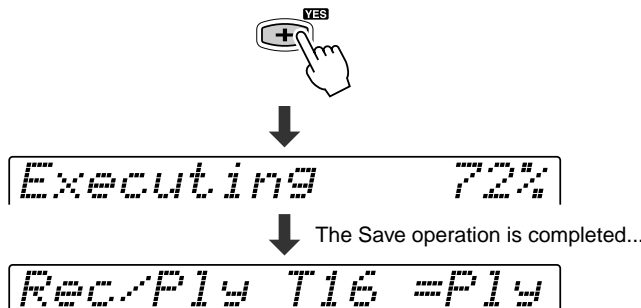

14 Press the [RECORD] button to exit from the Record mode.

Re-recording — Punch In/Out and Start Measure

This section shows you how to re-record a specific section of a already-recorded song. In the eight-measure example below, the third measures through the fifth measure are re-recorded.

● Before re-recording

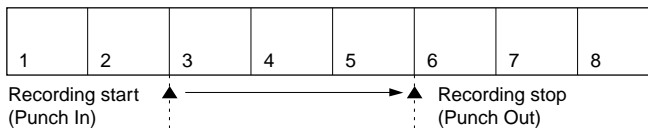

● After re-recording

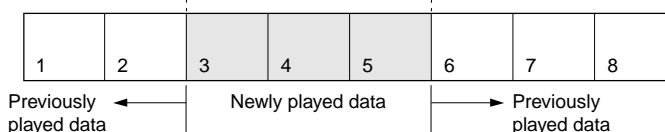

- 1 Insert the floppy disk into the disk drive.
- 2 Press the [RECORD] button to engage the Record mode.



- 3 Select "Song".
Use the **data dial**, the [+ / YES] button or the [- / NO] button.

RecMenu: Song

- 4 Press the [NEXT] button to display the Song selection screen.

001 New Song

- 5 Select the Song you want to re-record.
Use the **data dial**, the [+ / YES] button or the [- / NO] button.

002 SONG_001.MID

- 6 Press the [NEXT] button again to display the RecMode screen.

- 7 Select "MultiRec".
Use the **data dial**, the [+ / YES] button or the [- / NO] button.

SongRec: MultiRec

8 Press the [NEXT] button to display the Punch In/Out screen.

9 Select “On”.

Use the **data dial**, the [+ / YES] button or the [- / NO] button.

Punch In/Out=On

10 Press the [NEXT] button to display the Punch In measure screen.

11 Set the punch-in measure.

Use the **data dial**, the [+ / YES] button, the [- / NO] button or the number buttons [1]-[0].

Punch In = 3

12 Press the [NEXT] button to display the Punch Out measure screen.

13 Set the punch-out measure.

Use the **data dial**, the [+ / YES] button, the [- / NO] button or the number buttons [1]-[0].

Punch Out = 5

NOTE

- The punch-out measure number cannot be set lower than the punch-in measure number.

14 Press the [NEXT] button to display the START MEASURE screen.

15 Set the start measure (the measure at which playback starts).

Use the **data dial**, the [+ / YES] button, the [- / NO] button or the number buttons [1]-[0].

RecStart Mes= 2

NOTE

- Punch In/Out recording cannot be used with the auto accompaniment tracks.
- During recording you can use the TRACK buttons to turn playback of previously-recorded tracks on or off as required.

16 Press the [NEXT] button to display the PART screen.

17 Record using the same operation as described in “Multi Track Recording” on page 82, starting with step #7.

Quantize

Quantize lets you “clean up” or “tighten” the timing of a previously recorded track. For example, the following musical passage has been written with exact quarter-note and eighth-note values.



Even though you think you may have recorded the passage accurately, your actual performance may be slightly ahead of or behind the beat (or both!). Quantize allows you to align all the notes in a track so that the timing is absolutely accurate to the specified note value.

1-4 Use the same operation as in “Re-recording” (page 84).

5 Select the Song file to be quantized.

Use the **data dial**, the [+ / YES] button or the [- / NO] button.

```
002 SONG_001.MID
```

6 Press the [NEXT] button again to display the RecMode screen.

7 Select “Edit”.

Use the **data dial**, the [+ / YES] button or the [- / NO] button.

```
SongRec#Edit
```

8 Press the [NEXT] button to display the Edit Menu screen.

9 Select “Quantize”.

Use the **data dial**, the [+ / YES] button or the [- / NO] button.

```
SngEdit#Quantize
```

10 Press the [NEXT] button to display the Track selection screen.

11 Select the track to be quantized.

Use the **data dial**, the [+ / YES] button or the [- / NO] button.

```
QuantizTrack=T05
```

12 Press the [NEXT] button.

QuantizeSize=1/4

13 Select the Quantize size (resolution).

Use the **data dial**, the [+/**YES**] button or the [-/**NO**] button.

Set the Quantize resolution to correspond to the smallest notes in the track you are working with. For example, if the data was recorded with both quarter notes and eighth notes, use 1/8 for the quantize resolution. If the quantize function is applied in this case with the resolution set to 1/4, the eighth notes would be moved on top of the quarter notes.

● **Quantize size**

Size	Note
1/4	Quarter note
1/6	Quarter note triplet
1/8	Eighth note
1/12	Eighth note triplet
1/16	Sixteenth note
1/24	Sixteenth note triplet
1/32	Thirty-second note

One measure of 8th notes before quantization



After quantization



14 Press the [NEXT] button to display the Quantize operation screen.

Quantize OK?

NOTE

• You cannot restore the original data once you've executed the Quantize operation. If space exists on the disk, save the original song data (as a backup), then use Quantize. If you don't like the results, you can reload the backup song data.

15 Press the [+/**YES**] button to execute the Quantize operation.

To abort the Quantize operation, press the [-/**NO**] button.

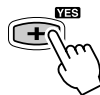

Executing 84%



The Quantize operation is completed...

Completed

CAUTION

• While the Quantize operation is being executed, never eject the floppy disk or turn the power off.

16 Press the [RECORD] button to exit from the Record mode.

Editing Setup Data

This function lets you make changes to various setup data (voice-related parameters) for each track of a recorded song. The following parameters can be edited:

- Voice Assigns a voice number to the specified track.
- Volume Sets the volume of the specified track.
- Octave Shifts the pitch of the specified track up or down by one or two octaves. A setting of “0” produces normal pitch.
- Pan Positions the sound of the specified track from left to right in the stereo sound field. A setting of “-7” is full left, “7” is full right, “0” is center, and all other settings are corresponding positions in between.
- Reverb depth Sets the reverb depth for the specified track, and thus the amount of reverb effect applied to that voice or track.
- Chorus depth Sets the chorus depth for the specified track, and thus the amount of chorus effect applied to that voice or track.
- DSP depth Sets the DSP depth for the specified track, and thus the amount of DSP effect applied to that voice or track.

NOTE

• Only one of the Setup parameters can be recorded to each track, and any parameter changes made in the middle of the song will be cancelled. However, in the case of Volume data, any Volume changes in the middle of the song are applied as an offset to the initial Setup Data setting.

1-4 Use the same operation as in “Re-recording” (page 84).

5 Select the file (song) for which you wish to change the setup data.

Use the **data dial**, the [+ / YES] button or the [- / NO] button.

002 UserSong1

6 Press the [NEXT] button again to display the RecMode screen.

7 Select “Edit”.

Use the **data dial**, the [+ / YES] button or the [- / NO] button .

SongRec: Edit

8 Press the [NEXT] button to display the Edit Menu screen.

9 Select “Setup Dt”.

Use the **data dial**, the [+ / YES] button or the [- / NO] button.

SngEdit: Setup Dt

10 Press the [NEXT] button to display the setup data screen.

11 Edit the setup data.

Press the [NEXT] and [BACK] buttons to switch among the displays (as shown below).

- Select a track by pressing one of the [TRACK1]-[TRACK16] buttons.
- Use the **data dial**, the [+ / YES] button, the [- / NO] button or the number buttons [1]-[0] to change the desired values in each display.

NOTE

- Minus settings for the Octave and Pan parameters can be directly entered by pressing the appropriate number button while holding the [- / NO] button.

• Voice	T01=001 GrandFno
	[NEXT] button ↓ ↑ [BACK] button
• Volume	Volume T01=108
	[NEXT] button ↓ ↑ [BACK] button
• Octave	Octave T01= 1
	[NEXT] button ↓ ↑ [BACK] button
• Pan	Pan T01= 63
	[NEXT] button ↓ ↑ [BACK] button
• Reverb depth	RevDepth T01= 49
	[NEXT] button ↓ ↑ [BACK] button
• Chorus depth	ChoDepth T01= 89
	[NEXT] button ↓ ↑ [BACK] button
• DSP depth	DspDepth T01= 89

12 Press the [NEXT] button to display the setup data saving screen.

Setup Data OK?

13 Save the changed data to the floppy disk.

- To cancel the save operation (if you wish to redo any edits), press the [- / NO] button and continue editing.
- To save the data to disk, press the [+ / YES] button.

CAUTION

- While the file is being saved, never eject the floppy disk or turn the power off.

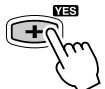
 ↓
 Executing 84%
 ↓ The Save operation is completed...
 Completed

14 Press the [RECORD] button to exit from the Record mode.

Naming User Songs

- 1 - 4** Use the same operation as in “Re-recording” (page 84).
- 5** Select the file (song) for which you wish to change the name.
Use the **data dial**, the [+ / YES] button or the [- / NO] button.

002 UserSong1

- 6** Press the [NEXT] button again to display the RecMode screen.
- 7** Select “Edit”.
Use the **data dial**, the [+ / YES] button or the [- / NO] button.

SongRec:Edit

- 8** Press the [NEXT] button to display the Edit Menu screen.
- 9** Select “Name”.
Use the **data dial**, the [+ / YES] button or the [- / NO] button.

SnSEdit:Name

- 10** Press the [NEXT] button to display the NAME screen.

Name=UserSong1
↙
cursor

- 11** Enter the desired name for the file (song).
Use the keyboard to enter the name (page 21).
Up to 12 letters or characters can be used. (The three-letter extension cannot be changed.)
- 12** Press the [RECORD] button to exit from the Record mode.

Clearing User Song Data

1 - 4 Use the same operation as in “Re-recording” (page 84).

5 Select the song file to be cleared.

Use the **data dial**, the [+ / YES] button or the [- / NO] button.

6 Press the [NEXT] button again to display the RecMode screen.

7 Select “Edit”.

Use the **data dial**, the [+ / YES] button or the [- / NO] button.

8 Press the [NEXT] button to display the Edit Menu screen.

9 Select “Clear”.

Use the **data dial**, the [+ / YES] button or the [- / NO] button.

SngEdit:Clear

10 Press the [NEXT] button.

Clear Track =T13

11 Select the track to be cleared.

Use the **data dial**, the [+ / YES] button or the [- / NO] button.

To clear the data of an entire song, select “ALL”.

12 Press the [NEXT] button.

Clear Track OK?

13 Press the [+ / YES] button to execute the Clear operation.

To abort the Clear operation, press the [- / NO] button.

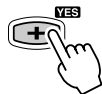

Executing 84%

↓ The Clear operation is completed...

Completed

⚠ CAUTION

- While the track is being cleared, never eject the floppy disk or turn the power off.

14 Press the [RECORD] button to exit from the Record mode.

Multi Pad Recording

In addition to the preset Multi Pad sets, the PSR-550 has 16 user-recordable sets that you can use to store your own creations. These original User Multi Pads can be played and used in the same way as the presets. User Multi Pad data can also be saved to and loaded from floppy disk.

Your keyboard performance (using voice R1) is recorded to the User pad. Chord Match data (page 43) can also be recorded.

- Multi Pad Recording page 92
- Chord Match page 94
- Naming User Pads page 94
- Clearing User Pad Data page 95

■ Data that can be recorded to User pads

- Note on/off (key press and release)
- Velocity (strength of key press)
- Pitch bend, pitch bend range
- SUSTAIN button on/off
- Footswitch on/off (sustain, sostenuto, soft)
- Voice Change settings
- Mixer settings

Up to approximately 2,000 notes for all pads can be recorded to the PSR-550 Multi Pads.

NOTE

- User Pad data is recorded by playing voice R1 from the keyboard. Voice R2, voice L and the auto accompaniment cannot be used.

NOTE

- Material recorded data is retained in memory even when the STANDBY switch is turned off if batteries are installed or an AC adaptor is connected (page 136). It is nevertheless a good idea to save important data to floppy disk so that you can keep them indefinitely and build up your own data library (page 60).

NOTE

The following notes and cautions are important points for you to keep in mind as you record your Multi Pad data.

- Using the Metronome function (page 118) can make your recording sessions much more efficient.
- Using Registration Memory (page 54) can make your recording sessions much more efficient, since various settings (such as voices, etc.) can be recalled by a single button press. When the record mode is engaged, the Registration Memory Freeze function will be turned on (it cannot be turned off while the record mode is engaged).
- Whenever you record, any previously recorded material in the same track will be erased.
- If the memory becomes full while recording, an alert message will appear on the display and recording will stop.
- Be careful to avoid turning off the power or unplugging the AC adaptor from the outlet during recording, since this will result in the loss of recorded data.

Multi Pad Recording

- 1 Press the [RECORD] button to engage the Record mode.



- 2 Select "MultiPad".

Use the **data dial**, the [+ / YES] button or the [- / NO] button.

RecMenu:MultiPad

- 3 Press the [NEXT] button.

PadBank=UserPad1

- 4 Select a Multi Pad Bank to record.

Use the **data dial**, the [+ / YES] button or the [- / NO] button.

5 Press the [NEXT] button to display the RecMode screen.

6 Select "Record".

Use the **data dial**, the [+ / YES] button or the [- / NO] button.

M. Pad Rec: Record

7 Press the [NEXT] button to display the pad number selection screen.

8 Select a Pad number to record.

Use the **data dial**, the [+ / YES] button, the [- / NO] button, or the MULTI PAD buttons [1]-[4].

Rec Pad =Pad1

9 Press the [NEXT] button to display the Rehearsal screen.

Voices can be set from this display. After completing the desired settings, press the [EXIT] button to return to this display.

Rehearsal

10 Press the [NEXT] button to display the Record ready screen.

The beat indicator dots will flash at the currently set tempo, indicating that the record ready (Synchro Start) mode is engaged.



M. Pad Rec Ready

11 Start recording.

- Recording starts as soon as you play a key on the keyboard.
- Recording can also be started by pressing the [START/STOP] button.

M. Pad Recording

If you are recording a Chord match phrase, use only the CM7 scale tones (i.e. C, D, E, G, A and B).

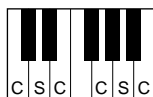

C = chord tone
C, S = scale tones

12 Press the [START/STOP] button to stop recording.

13 Press the [RECORD] button to exit from the Record mode.

Chord Match

1-5 Use the same operation as in “Multi Pad Recording” (page 92).

6 Select “Edit”.
Use the **data dial**, the [+/**YES**] button or the [-/**NO**] button.

M. Pad Rec: Edit

7 Press the [**NEXT**] button to display the Edit menu screen.

8 Select “ChdMatch”.
Use the **data dial**, the [+/**YES**] button or the [-/**NO**] button.

PadEdit: ChdMatch

9 Press the [**NEXT**] button to display the Chord Match screen.

10 Turn the Chord Match function on or off.

- Use the **data dial**, the [+/**YES**] button or the [-/**NO**] button.
- To select the desired pad for setting, press the [**NEXT**] button.

CdMatch Pad1=Off

[**NEXT**] button ↓ ↑ [**BACK**] button

CdMatch Pad2=Off

[**NEXT**] button ↓ ↑ [**BACK**] button

⋮

11 Press the [**RECORD**] button to exit from the Record mode.

Naming User Pads

1-7 Use the same operation as in “Chord Match” above.

8 Select “Name”.
Use the **data dial**, the [+/**YES**] button or the [-/**NO**] button.

PadEdit: Name

9 Press the [**NEXT**] button to display the Name screen.

10 Enter the desired name for the bank.

Use the keyboard to enter the name (page 21).
Up to eight letters or characters can be used.

PadName=UserPad2

Cursor

11 Press the [RECORD] button to exit from the Record mode.**Clearing User Pad Data****1-7** Use the same operation as in “Chord Match” (page 94).**8** Select “Clear”.

Use the **data dial**, the [+/**YES**] button or the [-/**NO**] button.

PadEdit:Clear

9 Press the [NEXT] button.

Clr Pad=Pad1

10 Select the Pad number to be cleared.

Use the **data dial**, the [+/**YES**] button or the [-/**NO**] button.
To clear the data from all four pads, select “All”.

11 Press the [NEXT] button.

Clear Pad OK?

12 Execute the Clear operation.

Press the [+/**YES**] button to execute the Clear operation.
To abort the Clear operation, press the [-/**NO**] button.



↓ The Clear operation is completed...

Completed

13 Press the [RECORD] button to exit from the Record mode.

Style Recording

The PSR-550 lets you record up to three original User styles which can be used for auto accompaniment in the same way as the preset styles. User Style data can also be saved to and loaded from floppy disk (page 57).

You can create a User style by using the internal style data as a starting point. Select a preset style that is closest to the type of style you want to create, and record the auto accompaniment patterns to each section.

The PSR-550 provides two basic ways to record styles:

- Style Recording — Rhythm Track page 98
- Style Recording — Bass/Phrase/Pad/Chord Tracks page 100

The four editing features below allow you to edit already recorded style data.

- Quantize page 102
This function aligns the timing of the recorded note data to a specified value.
- Naming User Styles page 104
This function lets you name your original styles.
- Clearing User Style Data page 104
This function is for clearing (deleting) or part of the recorded style.

■ User Style Tracks

The tracks which can be recorded to the User styles are organized as shown in the chart below.

Section	Track			
INTRO	RHYTHM SUB	CHORD1	PHRASE1	BASS
	RHYTHM MAIN	CHORD2	PHRASE2	PAD
MAIN A	RHYTHM SUB	CHORD1	PHRASE1	BASS
	RHYTHM MAIN	CHORD2	PHRASE2	PAD
MAIN B	RHYTHM SUB	CHORD1	PHRASE1	BASS
	RHYTHM MAIN	CHORD2	PHRASE2	PAD
FILL IN A	RHYTHM SUB	CHORD1	PHRASE1	BASS
	RHYTHM MAIN	CHORD2	PHRASE2	PAD
FILL IN B	RHYTHM SUB	CHORD1	PHRASE1	BASS
	RHYTHM MAIN	CHORD2	PHRASE2	PAD
ENDING	RHYTHM SUB	CHORD1	PHRASE1	BASS
	RHYTHM MAIN	CHORD2	PHRASE2	PAD

NOTE

• Material recorded data is retained in memory even when the STANDBY switch is turned off if batteries are installed or an AC adaptor is connected (page 136). It is nevertheless a good idea to save important data to floppy disk so that you can keep them indefinitely and build up your own data library (page 60).

On the PSR-550, you can record up to a total of 48 tracks (6 sections x 8 tracks).

■ Data that can be recorded to User styles

- Note on/off (key press and release) page 107
- Velocity (strength of key press) page 107
- Pitch bend, pitch bend range pages 30, 122
- Voice number (drum kit number)* page 26
- Mixer settings* page 76
- Tempo page 36
- Reverb type and settings page 46
- Chorus type and settings page 48

NOTE

• User Style data is recorded by playing voice R1 from the keyboard. Voice R2, voice L and the auto accompaniment cannot be used.

Up to approximately 1,950 notes for a section (a total of about 7,150 notes) can be recorded to the PSR-550 style tracks.

Only one event of the item marked with * can be recorded for each track of the sections.

■ About Recording User Styles

In recording a User song, the PSR-550 records your keyboard performance as MIDI data. Recording of User styles, however, is done in a different way. Here are some of the aspects in which style recording differs from song recording:

Loop Recording

Auto accompaniment repeats the accompaniment patterns of several measures in a “loop,” and style recording is also done using loops. For example, if you start recording with a two-measure main section, the two measures are repeatedly recorded. Notes that you record will play back from the next repetition (loop), letting you record while hearing previously recorded material.

Overdub Recording

This method records new material to a track already containing recorded data, without deleting the original data. In style recording, the recorded data is not deleted, except when using functions such as Clear (page 104) and Drum Cancel (page 99).

For example, if you start recording with a two-measure main section, the two measures are repeated many times. Notes that you record will play back from the next repetition, letting you overdub new material to the loop while hearing previously recorded material.

Using Preset Styles

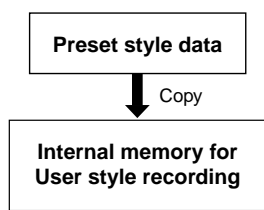

As shown in the chart at left, when you select the internal preset style that is the closest to the type of style you wish to create, the preset style data will be copied to a special memory location for recording.

You create (record) your new, original style by adding or deleting data from the memory location.

All tracks (with the exception of the rhythm track) must be cleared before recording (page 104).

NOTE

The following notes and cautions are important points for you to keep in mind as you record your User styles.

- Make sure to clear at least one of the three User styles before recording a new User style. Recording a new User style cannot be started when all three User styles have recorded data.
- Be careful to avoid turning off the power or unplugging the AC adaptor from the outlet during recording, since this will result in the loss of recorded data.
- Using Registration Memory (page 54) can make your recording sessions much more efficient, since various settings (such as voices, etc.) can be recalled by a single button press. When the record mode is engaged, the Registration Memory Freeze function will be turned on (it cannot be turned off while the record mode is engaged).
- Using the Metronome function (page 118) can make your recording sessions much more efficient.
- In the Record Ready mode, you can exchange or edit the voice data in the recorded tracks using Mixer on page 76.
- If the memory becomes full while recording, an alert message will appear on the display and recording will stop.
- Since recording is done in measure units, you should first select a style that has the same number of measures as the section you intend to record.
- If none of the preset styles is appropriate, select one that has the same time signature and number of measures as the one you want to create, then use the Clear function (page 104) to clear all preset data before entering your own.

Style Recording — Rhythm Track

With this operation you can create your own original rhythm patterns by editing existing rhythm track (percussion) data from a preset style.

- 1 Press the [RECORD] button to engage the Record mode.



- 2 Select “Style”.

Use the data dial, the [+ / YES] button or the [- / NO] button.

RecMenu: Style

- 3 Press the [NEXT] button.

001 8Beat 1

- 4 Select a style to begin with.

Use the data dial, the [+ / YES] button, the [- / NO] button or the number buttons [1]-[0].

- 5 Press the [NEXT] button again to display the RecMode screen.

- 6 Select “Record”.

Use the data dial, the [+ / YES] button or the [- / NO] button.

Style Rec: Record

- 7 Press the [NEXT] button to display the Section selection screen.

- 8 Select the section to be recorded.

Section =Main A

- 9 Press the [NEXT] button to display the Track selection screen.

NOTE

- Multiple sections cannot be recorded at the same time.

10 Select a Rhythm track to be recorded.

Select “RHYTHM MAIN” or “RHYTHM SUB” with the **data dial**, the **[+/YES]** button or the **[-/NO]** button.

Record Track = RHM

NOTE

- Only one track can be recorded at a time.

11 Press the [NEXT] button to display the Rehearsal screen.

The beat indicator dots will flash at the currently set tempo, indicating that the record ready (Synchro Start) mode is engaged.

Rehearsal

12 Select one of the Drum Kits.

Select the desired kit by pressing the **[VOICE R1]** button (page 26).

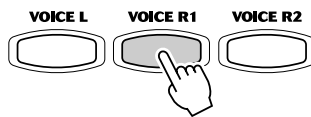

To return to the original display, press the **[EXIT]** button (page 17).

13 Start recording.

You can start recording with one of the following ways:

- Press the **[START/STOP]** button. The following will start to play back: the style selected in step #4, the section selected in step #8 and the rhythm track selected in step #10.
- Press the **[SYNC START]** button to enable synchronized standby (page 25), then play a key on the keyboard. Playback starts as described in the first method above.

Style Recording

NOTE

- For recording the RHYTHM tracks, the instrument symbols printed on the front edge of the panel show you the instrument assignments to each key. See “Keyboard Percussion” on page 31 for playing each drum/ percussion sound.

Since the rhythm pattern plays back repeatedly, you can record by overdubbing — listening to the pattern and playing the desired keys. Look at the icons printed under the keys indicating the percussion sounds that are assigned to each key.

You can also delete certain percussion sounds in the following way:

- 1) Press the **[NEXT]** button.

Drum Cancel

- 2) Press the key on the keyboard corresponding to the instrument you want to cancel.
- 3) To return to the original display, press the **[BACK]** button.

14 Press the [START/STOP] button to stop recording.

15 Press the [RECORD] button to exit from the Record mode.

You should save the recorded data before leaving the recording mode. (Refer to page 100 for details.)

Exiting from the Style Record mode

To leave the style recording mode, follow the instructions in the chart below.

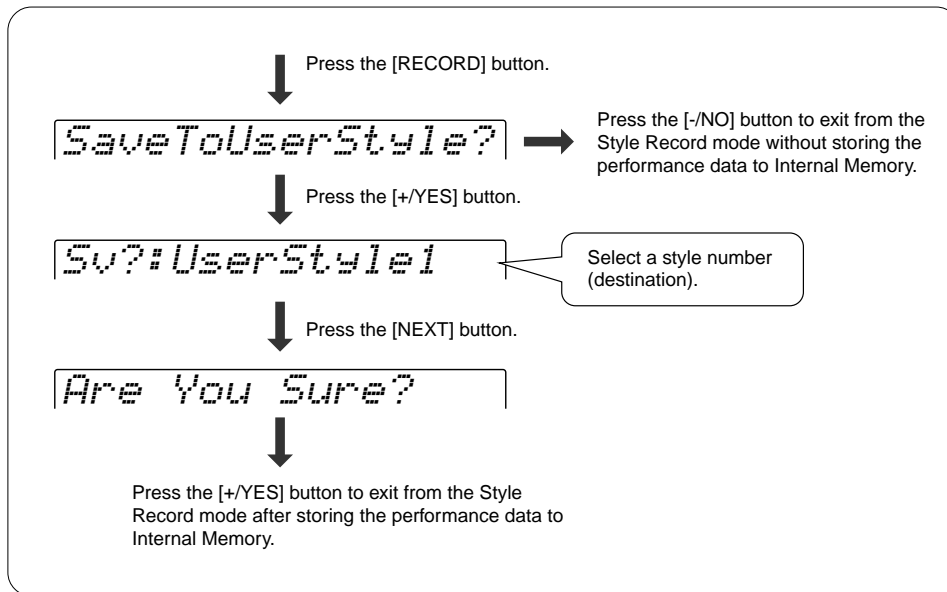

NOTE

- After exiting from the Style Recording mode, the section automatically switches to Main B. If you record a section other than Main B, select the section again and play the accompaniment.

Style Recording — Bass/Phrase/Pad/Chord Tracks

This section explains how to record all tracks (other than the rhythm), using the preset styles.

Unlike recording the rhythm track, in this method you have to clear the track data of the original style before recording.

1-9 Use the same operation as in “Style Recording — Rhythm Track” (page 98).

10 Select a Track to be recorded.

Use the **data dial**, the [+YES] button or the [-/NO] button.

Select from the following: “BASS,” “CHORD1,” “CHORD2,” “PAD,” “PHRASE1,” and “PHRASE2”.

Record Track=Bas

11 Press the [NEXT] button to display the Record Ready screen.

Song Rec Ready

NOTE

- Only one track can be recorded at a time.

CAUTION

- Be aware that this process automatically clears the data in the track selected in step #10.

12 Select a voice for the track to be recorded.

Select the desired voice by pressing the [VOICE R1] button (page 26).



To return to the previous display, press the [EXIT] button.

13 Start recording.

You can start recording with one of the following ways:

- Press the [START/STOP] button.
- Press the [SYNC START] button to enable synchronized standby (page 25), then play a key on the keyboard.

Style Recording

The recording repeats indefinitely (until stopped) in a loop.

Notes that you record will play back from the next repetition, letting you record while hearing previously recorded material.

Observe the following rules when recording the MAIN and FILL sections:

- Use only the CM7 scale tones when recording the BASS and PHRASE tracks (i.e. C, D, E, G, A and B).
- Use only the chord tones when recording the CHORD and PAD tracks (i.e. C, E, G and B).



C = chord tone
C, S = scale tones

Any appropriate chord or chord progression can be used for the INTRO and ENDING sections.

14 Press the [START/STOP] button to stop recording.

15 Press the [RECORD] button to exit from the Record mode.

For information on leaving the recording mode, see page 100.

Quantize

Quantize lets you “clean up” or “tighten” the timing of a previously recorded track. For example, the following musical passage has been written with exact quarter-note and eighth-note values.



Even though you think you may have recorded the passage accurately, your actual performance may be slightly ahead of or behind the beat (or both!). Quantize allows you to align all the notes in a track so that the timing is absolutely accurate to the specified note value.

1-5 Use the same operation as in “Style Recording — Rhythm Track” (page 98).

6 Select “Edit”.
Use the **data dial**, the [+ / YES] button or the [- / NO] button.

Style Rec: Edit

7 Press the [NEXT] button to display the Edit Menu screen.

8 Select “Quantize”.
Use the **data dial**, the [+ / YES] button or the [- / NO] button.

StyEdit: Quantize

9 Press the [NEXT] button to display the Section selection screen.

10 Select the section to be quantized.
Use the **data dial**, the [+ / YES] button or the [- / NO] button.

Section =Main A

11 Press the [NEXT] button to display the Track selection screen.

12 Select the track to be quantized.
Use the **data dial**, the [+ / YES] button or the [- / NO] button.

QuantizTrack =Pad

13 Press the [NEXT] button.

Quantize Size = 1/4

14 Select the Quantize size (resolution).

Use the **data dial**, the [-/NO] button or the [+ /YES] button.

Set the Quantize resolution to correspond to the smallest notes in the track you are working with. For example, if the data was recorded with quarter notes and eighth notes, use 1/8 for the quantize resolution. If the quantize function is applied in this case with the resolution set to 1/4, the eighth notes would be moved on top of the quarter notes.

● Quantize size

Size	Note
1/4	Quarter note
1/6	Quarter note triplet
1/8	Eighth note
1/12	Eighth note triplet
1/16	Sixteenth note
1/24	Sixteenth note triplet
1/32	Thirty-second note

One measure of 8th notes before quantization



After quantization



15 Press the [NEXT] button to display the QUANTIZE operation screen.

Quantize OK?

- You can audition the quantized pattern in this step, allowing you to hear the results of the operation before actually changing the data. To audition the pattern, press the [START/STOP] button.

16 Press the [+ /YES] button to execute the Quantize operation.

To abort the Quantize operation, press the [- /NO] button.



The Quantize operation is completed...

Completed

17 Press the [RECORD] button to exit from the Record mode.

For information on leaving the recording mode, see page 100.

Naming User Styles

1-7 Use the same operation as in “Quantize” (page 102).

8 Select “Name”.

Use the **data dial**, the [+ / YES] button or the [- / NO] button.

A rectangular LCD screen displaying the text 'StyEdit:Name' in a monospaced font.

9 Press the [NEXT] button to display the Name screen.

A rectangular LCD screen displaying the text 'Name=UserStyle1'. A small cursor is positioned under the first '1' at the end of the line.

cursor

10 Enter the desired name for the style.

Use the keyboard to enter the name (page 21).

Up to 12 letters or characters can be used.

11 Press the [RECORD] button to exit from the Record mode.

For information on leaving the recording mode, see page 100.

Clearing User Style Data

1-7 Use the same operation as in “Quantize” (page 102).

8 Select “Clear”.

Use the **data dial**, the [+ / YES] button or the [- / NO] button.

A rectangular LCD screen displaying the text 'StyEdit:Clear' in a monospaced font.

9 Press the [NEXT] button to display the Section selection screen.

10 Select a Section to be cleared.

Use the **data dial**, the [+ / YES] button or the [- / NO] button.

When “All Sect” is selected as the section to be cleared, all style data (which includes all sections and all tracks) will be deleted. In this case, go to step #13, skipping over steps #11 and #12.

11 Press the [NEXT] button to display the Track selection screen.

12 Select a Track to be cleared.

Use the **data dial**, the [+ / YES] button or the [- / NO] button.

- 13** Press the [NEXT] button to display the Clear screen.

Clear OK?

- 14** Press the [+ / YES] button to execute the Clear operation.

To abort the Clear operation, press the [- / NO] button.



The Clear operation is completed...

Completed

- 15** Press the [RECORD] button to exit from the Record mode.

If you've selected a certain section (other than "ALL sect"), see the explanation on leaving the recording mode on page 100.

MIDI Functions

In the rear panel of your PSR-550, there are MIDI terminals (MIDI IN, MIDI OUT), a TO HOST terminal, and a HOST SELECT switch. By using the MIDI functions you can expand your musical possibilities. This section explains what MIDI is, and what it can do, as well as how you can use MIDI on your PSR-550.

- If you don't know what MIDI is, make sure to read these sections:
 - What's MIDI? page 106
 - What You Can Do With MIDI page 108
 - MIDI Data Compatibility page 109
- If you want to use your PSR-550 with a computer, read this section:
 - Connecting to a Personal Computer page 110
- The PSR-550 lets you make the following MIDI-related settings:
 - MIDI Template page 112
 - MIDI Transmit Setting page 114
 - MIDI Receive Setting page 115
 - Local Control page 116
 - Clock page 116
 - Initial Data Send page 117

What's MIDI?

No doubt you have heard the terms “acoustic instrument” and “digital instrument.” In the world today, these are the two main categories of instruments. Let's consider an acoustic piano and a classical guitar as representative acoustic instruments. They are easy to understand. With the piano, you strike a key, and a hammer inside hits some strings and plays a note. With the guitar, you directly pluck a string and the note sounds. But how does a digital instrument go about playing a note?

● Acoustic guitar note production

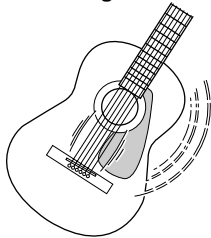

Pluck a string and the body resonates the sound.

● Digital instrument note production

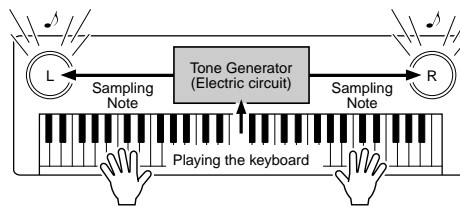

Based on playing information from the keyboard, a sampling note stored in the tone generator is played through the speakers.

As shown in the illustration above, in an electronic instrument the sampling note (previously recorded note) stored in the tone generator section (electric circuit) is played based on information received from the keyboard. So then what is the information from the keyboard that becomes the basis for note production?

For example, let's say you play a “C” quarter note using the grand piano sound on the PSR-550 keyboard. Unlike an acoustic instrument that puts out a resonated note, the electronic instrument puts out information from the keyboard such as “with what voice,” “with which key,” “about how strong,” “when was it pressed,” and “when was it released.” Then each piece of information is changed into a number value and sent to the tone generator. Using these numbers as a basis, the tone generator plays the stored sampling note.

● Example of Keyboard Information

Voice number (with what voice)	01 (grand piano)
Note number (with which key)	60 (C3)
Note on (when was it pressed) and note off (when was it released)	Timing expressed numerically (quarter note)
Velocity (about how strong)	120 (strong)

MIDI is an acronym that stands for Musical Instrument Digital Interface, which allows electronic musical instruments to communicate with each other, by sending and receiving compatible Note, Control Change, Program Change and various other types of MIDI data, or messages.

The PSR-550 can control a MIDI device by transmitting note related data and various types of controller data. The PSR-550 can be controlled by the incoming MIDI messages which automatically determine tone generator mode, select MIDI channels, voices and effects, change parameter values and of course play the voices specified for the various parts.

MIDI messages can be divided into two groups: Channel messages and System messages. Below is an explanation of the various types of MIDI messages which the PSR-550 can receive/transmit.

● Channel Messages

The PSR-550 is an electronic instrument that can handle 16 channels. This is usually expressed as “it can play 16 instruments at the same time.” Channel messages transmit information such as Note ON/OFF, Program Change, for each of the 16 channels.

Message Name	PSR-550 Operation/Panel Setting
Note ON/OFF	Messages which are generated when the keyboard is played. Each message includes a specific note number which corresponds to the key which is pressed, plus a velocity value based on how hard the key is struck.
Program Change	Voice setting (control change bank select MSB/LSB setting)
Control Change	Mixer (volume, pan pot, etc.)

● System Messages

This is data that is used in common by the entire MIDI system. System messages include messages like Exclusive Messages that transmit data unique to each instrument manufacturer and Realtime Messages that control the MIDI device.

Message Name	PSR-550 Operation/Panel Setting
Exclusive Message	Reverb/chorus/DSP settings, etc.
Realtime Messages	Clock setting Start/stop operation

NOTE

- The performance data of all songs, styles and Multi Pads is MIDI data.

The messages transmitted/received by the PSR-550 are shown in the MIDI Data Format and MIDI Implementation Chart on pages 139 and 151.

MIDI and TO HOST terminals

In order to exchange MIDI data between multiple devices, each device must be connected by a cable.

There are two ways to connect: from the MIDI terminals of the PSR-550 to the MIDI terminals of an external device using a MIDI cable, or from the TO HOST port of the PSR-550 to the serial port of a personal computer using a special cable.

If you connect from the PSR-550 TO HOST terminal to a personal computer, the PSR-550 will be used as a MIDI interface device, meaning that a specialized MIDI interface device is not necessary.

In the rear panel of the PSR-550, there are two kinds of terminals, the MIDI terminals and the TO HOST terminal.



- MIDI IN Receives MIDI data from another MIDI device.
- MIDI OUT Transmits the PSR-550's keyboard information as MIDI data to another MIDI device.
- TO HOST Transmits and receives MIDI data to and from a personal computer.

NOTE

- When using the TO HOST terminal to connect to a personal computer using Windows, a Yamaha MIDI driver must be installed in the personal computer. The included disk contains the Yamaha MIDI driver.
- Special MIDI cables (sold separately) must be used for connecting to MIDI devices. They can be bought at music stores, etc.
- Never use MIDI cables longer than about 15 meters. Cables longer than this can pick up noise which can cause data errors.

The PSR-550 is an electronic musical instrument which is capable of transmitting and receiving over sixteen channels. Imagine that there are sixteen separate pipes in the connected MIDI cable. When transmitting MIDI data from the PSR-550 to an external device, MIDI data is sent through the assigned pipe (or MIDI channel) and transmitted to the external device.

For example, several tracks can be transmitted simultaneously, including the auto accompaniment data (as shown below).

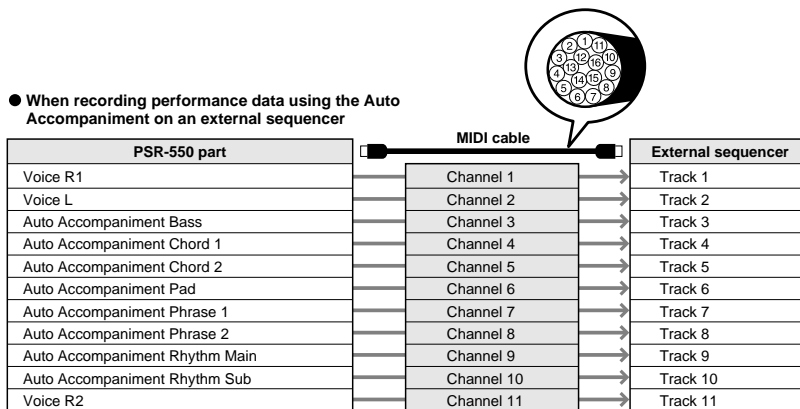

As you can see, it is essential to determine which data is to be sent over which MIDI channel when transmitting MIDI data (page 114).

What You Can Do With MIDI

- Use the PSR-550 as a multi tone generator (playing 16 channels at one time).

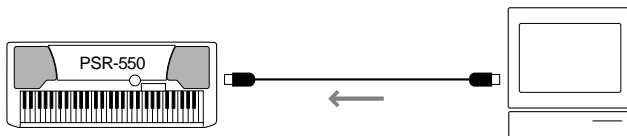

NOTE

• When using a personal computer, special software (sequencer software) is needed.

Receive mode for all channels set to “XG/GM.”
MIDI receive settings (page 115).

- Play music from another keyboard (no tone generator) using the PSR-550 XG tone generator.

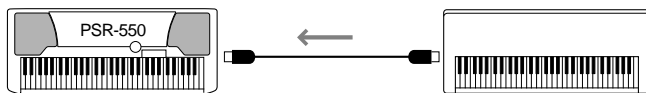

MIDI receive settings (page 115).

- Record performance data (1-16 channels) using the PSR-550 Auto Accompaniment on a external sequencer (such as a personal computer). After recording, edit the data with the sequencer, then play it again on the PSR-550 (playback).

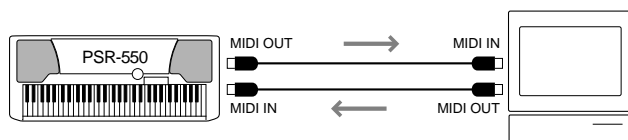

MIDI transmit settings (page 114).
Initial Data send (page 117).

MIDI Data Compatibility

This section covers basic information on data compatibility: whether or not other MIDI devices can playback the data recorded by PSR-550, and whether or not the PSR-550 can playback commercially available song data or song data created for other instruments or on a computer.

Depending on the MIDI device or data characteristics, you may be able to play back the data without any problem, or you may have to perform some special operations before the data can be played back. If you run into problems playing back data, please refer to the information below.

Sequence format

The system which records song data is called “sequence format.”

Playback is only possible when the sequence format of the disk matches that of the MIDI device.

● SMF (Standard MIDI File)

This is the most common sequence format.

Standard MIDI Files are generally available as one of two types: Format 0 or Format 1. Many MIDI devices are compatible with Format 0, and most commercially available software is recorded as Format 0.

- The PSR-550 is compatible with both Format 0 and Format 1.
- Song data recorded on the PSR-550 is automatically recorded as SMF Format 0.

● ESEQ

This sequence format is compatible with many of Yamaha's MIDI devices, including the Clavinova series instruments. This is a common format used with various Yamaha software.

- The PSR-550 is compatible with ESEQ.

● Style File

The Style File Format — SFF — is Yamaha's original style file format which uses a unique conversion system to provide high-quality automatic accompaniment based on a wide range of chord types.

- The PSR-550 uses the SFF internally, reads optional SFF style disks, and creates SFF styles using the Style recording feature.

Voice allocation format

With MIDI, voices are assigned to specific numbers, called “program numbers.” The numbering standard (order of voice allocation) is referred to as the “voice allocation format.”

Voices may not play back as expected unless the voice allocation format of the song data matches that of the compatible MIDI device used for playback.

● GM System Level 1

This is one of the most common voice allocation formats.

Many MIDI devices are compatible with GM System Level 1, as is most commercially available software.

- The PSR-550 is compatible with GM System Level 1.

● XG

XG is a major enhancement of the GM System Level 1 format, and was developed by Yamaha specifically to provide more voices and variations, as well as greater expressive control over voices and effects, and to ensure compatibility of data well into the future.

- The PSR-550 is compatible with XG.

● DOC

This voice allocation format is compatible with many of Yamaha's MIDI devices, including the Clavinova series instruments.

This is also a common format used with various Yamaha software.

- The PSR-550 is compatible with DOC.

NOTE

• Even if the devices and data used satisfy all the conditions above, the data may still not be completely compatible, depending on the specifications of the devices and particular data recording methods.

Connecting to a Personal Computer

Connect your PSR-550 to a computer and take advantage of the wide range of powerful and versatile software for creating and editing music. The PSR-550 can be connected in two ways:

- Using the MIDI terminals
- Using the TO HOST terminal

NOTE

- If your computer features a USB interface, we recommend using the Yamaha UX256.

Connect using the PSR-550 MIDI terminals

Using a MIDI interface device installed in the personal computer, connect the MIDI terminals of the personal computer and the PSR-550.

For the connection cable, use a special MIDI cable.

- When the computer has a MIDI interface installed, connect the MIDI OUT terminal of the personal computer to the MIDI IN terminal of the PSR-550. Set the HOST SELECT switch to “MIDI.”

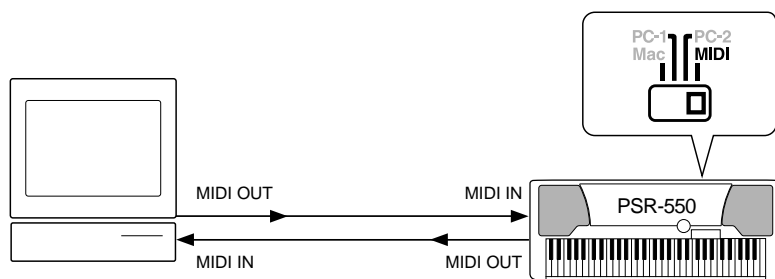

- When using a MIDI interface with a Macintosh series computer, connect the RS-422 terminal of the computer (modem or printer terminal) to the MIDI interface, then connect the MIDI OUT terminal on the MIDI interface to the MIDI IN terminal of the PSR-550, as shown in the diagram below. Set the HOST SELECT switch on the PSR-550 to “MIDI.”

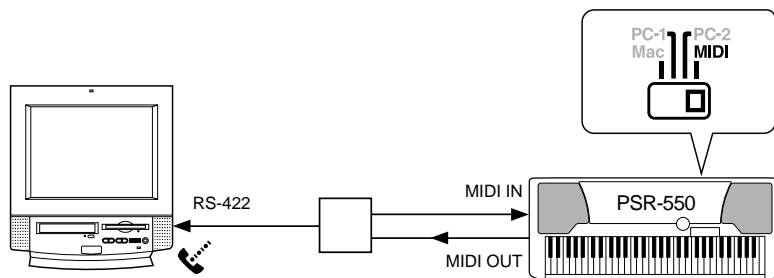

- When the HOST SELECT switch is set in the “MIDI” position, input and output in the TO HOST switch is ignored.
- When using a Macintosh series computer, set the MIDI interface clock setting in the application software to match the setting of the MIDI interface you are using. For details, carefully read the owner’s manual for the software you are using.

Connect using the TO HOST terminal

Connect the serial port of the personal computer (RS-232C terminal or RS-422 terminal) to the TO HOST terminal of the PSR-550.

For the connection cable, use the cable below (sold separately) that matches the personal computer type.

● IBM-PC/AT Series

Connect the RS-232C terminal on the computer to the TO HOST terminal on the PSR-550 using a serial cable (D-SUB 9P → MINI DIN 8P cross cable). Set the PSR-550 HOST SELECT switch in the “PC-2” position.

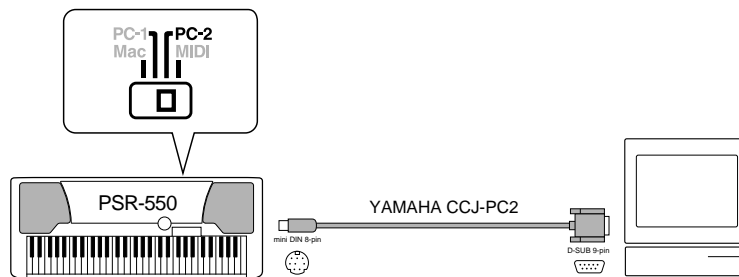

When using a D-SUB 25P → MINI DIN 8P cross cable, connect using a D-SUB 9P adaptor on the computer side of the cable.

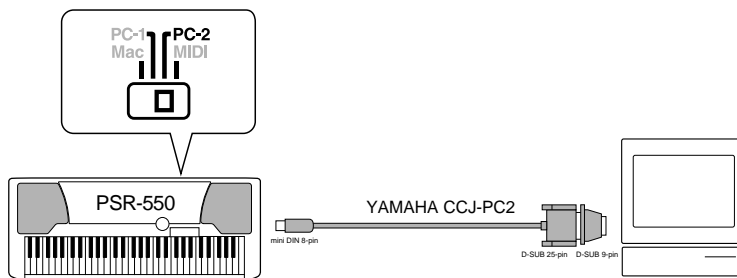

● Macintosh Series

Connect the RS-422 terminal (modem or printer terminal) on the computer to the TO HOST terminal on the PSR-550 using a serial cable (system peripheral cable, 8 bit). Set the PSR-550 HOST SELECT switch in the “Mac” position.

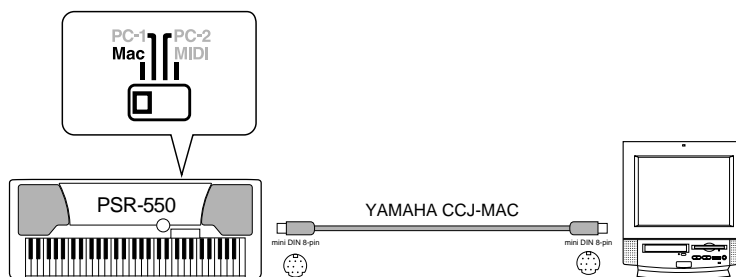

Set the MIDI interface clock in the sequencer software you are using to 1 MHz. For details, carefully read the owner's manual for the software you are using.

For details about the necessary MIDI settings for computer and sequence software you are using, refer to the relevant owner's manuals.

- Macintosh is a registered trademark of Apple Computer, Inc.
- IBM PC/AT is a trademark of International Business Machines Corp.
- Other company names and product names, etc. in this manual are registered trademarks or trademarks of those companies.

MIDI Template

The PSR-550 is capable of transmitting and receiving MIDI data over sixteen independent channels. For proper MIDI operation, it is necessary to determine which data is set to which channel.

The MIDI Template function allows you to instantly configure all appropriate transmit/receive settings with a single button press.

1 Press the [FUNCTION] button.



2 Select "Midi."

Use the **data dial**, the [+ / YES] button or the [- / NO] button.

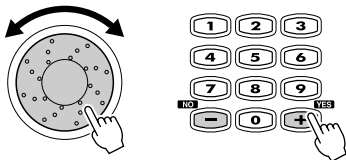

F4 Midi

3 Press the [NEXT] button to display the MIDI screen.

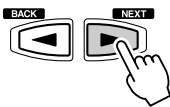

4 Select "Template."

Use the **data dial**, the [+ / YES] button or the [- / NO] button.

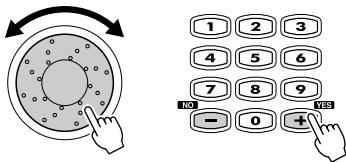

Midi # Template

5 Press the [NEXT] button to display the MIDI Template screen.

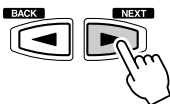

Temp=XG Module

6 Select a MIDI Template.

Use the **data dial**, the [+ / YES] button or the [- / NO] button.
For details, refer to the MIDI Template List (page 113).

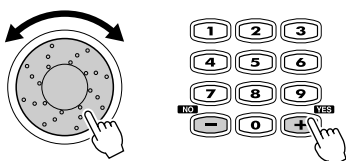

Temp=Acmf Out

7 Press the [NEXT] button.

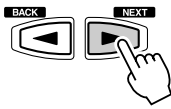

MidiTemplateLoad?

8 Load the selected MIDI Template.

Press the [+ / YES] button to actually load the selected MIDI template settings. To abort the operation, press the [- / NO] button.

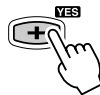

Completed

● **MIDI Template List**

Keyboard Out	The transmit channels are set as follows: ch. 1: Right1, ch. 2: Right2, ch. 3: Left, chs. 4-16: Off When outputting the performance data (note on/off messages). Used to play the PSR-550 note on/off data with an external tone generator and to record the PSR-550 note on/off data to an external sequencer.
Acmp Out	The transmit channels 9-16 are set with the Accompaniment tracks. chs. 1-8: Off, chs. 9-10: Rhythms, ch. 11: Bass, chs. 12-13: Chords, ch. 14: Pad, chs. 15-16: Phrases When outputting the style data. Used to play the PSR-550 auto accompaniment data with an external tone generator and to record the PSR-550 auto accompaniment data to an external sequencer.
Song Out	All transmit channels are set with the Song tracks 1-16. When outputting the song data. Used to play the PSR-550 song data with an external tone generator and to record your entire performance on the PSR-550 to an external sequencer.
Master Keyboard	When using the PSR-550 as a master keyboard; in other words, using it strictly as a controller for outputting MIDI data, without using the internal sounds.
XG Module	All receive channels are set to "XG/GM." When using the PSR-550 as a multi-timbral XG tone generator.
Accordion	The receive channels are set as follows: ch. 1: Remote, ch. 2: Chord, ch. 3: Bass, chs. 4-16: Off When playing the PSR-550 by an external MIDI Accordion. The connected MIDI accordion can play the PSR-550 and detect chords and basses in the auto accompaniment section.
Midi Pedal	All receive channels are set to "Root." When playing the PSR-550 using a connected (optional) MIDI pedal. The connected MIDI pedal detects chords and basses in the auto accompaniment section, allowing you to play on-bass chords.

MIDI Transmit Setting

The PSR-550 can simultaneously transmit data on all 16 MIDI channels. The Transmit Channel and Transmit Track functions determine what PSR-550 data is transmitted via which MIDI channels.

- 1** Press the [FUNCTION] button.
- 2** Select “Midi.”
Use the **data dial**, the [+ / YES] button or the [- / NO] button.
- 3** Press the [NEXT] button to display the MIDI screen.
- 4** Select “Transmit Ch.”
Use the **data dial**, the [+ / YES] button or the [- / NO] button.

Midi # Transmit Ch

- 5** Press the [NEXT] button to display the MIDI Transmit Ch screen.
- 6** Set a MIDI Transmit Channel and Transmit Track.

- Press one of the [TRACK1]-[TRACK16] buttons to select a MIDI channel.

Trans Ch16=R1

- Select a track with the **data dial**, the [+ / YES] button or the [- / NO] button.

Off	Nothing is transmitted.
R1	Right-hand keyboard playing* (VOICE R1)**
R2	Right-hand keyboard playing* (VOICE R2)**
L	Left-hand keyboard playing* (VOICE L)**
Upper	Right-hand keyboard playing* (Outputs MIDI note data normally as explained on page 29.)
Lower	Left-hand keyboard playing* with Auto Accompaniment ON (Outputs MIDI note data normally as explained on page 29.)
RhM	Auto Accompaniment RHYTHM MAIN track
RhS	Auto Accompaniment RHYTHM SUB track
Bas	Auto Accompaniment BASS track
Cd1	Auto Accompaniment CHORD1 track
Cd2	Auto Accompaniment CHORD2 track
Pad	Auto Accompaniment PAD track
Ph1	Auto Accompaniment PHRASE1 track
Ph2	Auto Accompaniment PHRASE2 track
T01-16	Song track 1-16

* “Right-hand keyboard playing” and “Left-hand keyboard playing” indicate the performance played on the right side and left side of the keyboard from the split point, respectively.

** Outputs MIDI note data according to the respective octave settings for the voices R1, R2 and L.

NOTE

- When a track is assigned to more than one MIDI channel, the data from that track is transmitted via the lowest-numbered channel.
- MIDI transmit track settings will be retained even after turning the power off. See page 136 for details.
- The initial default channel/track settings are:
 - Ch. 1 = R1
 - Ch. 2 = R2
 - Ch. 3 = L
 - Ch. 4 = Off
 - Ch. 5 = Off
 - Ch. 6 = Off
 - Ch. 7 = Off
 - Ch. 8 = Off
 - Ch. 9 = RhS
 - Ch. 10 = RhM
 - Ch. 11 = Bas
 - Ch. 12 = Cd1
 - Ch. 13 = Cd2
 - Ch. 14 = Pad
 - Ch. 15 = Ph1
 - Ch. 16 = Ph2
- To avoid MIDI loops which can cause operational errors, check the PSR-550 Local Control setting (page 116), and the MIDI THRU settings of any external MIDI devices.

MIDI Receive Setting

The PSR-550 can simultaneously receive data on all 16 MIDI channels, allowing it to function as a 16-channel multi-timbral tone generator. The Receive Channel and Receive Mode functions determine how each channel will respond to received MIDI data.

- 1** Press the [FUNCTION] button.
- 2** Select “Midi.”
Use the **data dial**, the [+ / YES] button or the [- / NO] button.
- 3** Press the [NEXT] button to display the MIDI screen.
- 4** Select “Receive Ch.”
Use the **data dial**, the [+ / YES] button or the [- / NO] button.

Midi # Receive Ch

- 5** Press the [NEXT] button to display the MIDI Receive Ch screen.
- 6** Set a MIDI Receive Channel and Receive mode.

- Press one of the [TRACK1]-[TRACK16] buttons to select a MIDI channel.

Reciv Ch01=XG/GM

- Select a receive mode with the **data dial**, the [+ / YES] button or the [- / NO] button.

Off	No MIDI data is received on channels set to “Off”.
XG/GM	Received MIDI data is sent directly to the PSR-550 tone generator. If all channels are set to “XG/GM”, the PSR-550 functions as a 16-channel multi-timbral tone generator.
Keybd	Received MIDI data is handled in the same way as data generated by the PSR-550’s own keyboard. In other words, a remote keyboard could be used to control the PSR-740/640 AUTO ACCOMPANIMENT functions, etc.
Chord	The note on/off messages received at the channel(s) set to “Chord” are recognized as the fingerings in the accompaniment section. The chords to be detected depend on the fingering mode on the PSR-550. The chords will be detected regardless of the accompaniment on/off and split point settings on the PSR-550 panel.
Root	The note on/off messages received at the channel(s) set to “Root” are recognized as the bass notes in the accompaniment section. The bass notes will be detected regardless of the accompaniment on/off and split point settings on the PSR-550 panel.

NOTE

- The initial default setting (factory setting) for all channels is “XG/GM.”
- MIDI receive mode settings will be retained even after turning the power off. See page 136 for details.

Local Control

“Local Control” refers to the fact that, normally, the PSR-550 keyboard controls the internal tone generator, allowing the internal voices to be played directly from the keyboard. This situation is “Local Control on” since the internal tone generator is controlled locally by its own keyboard. Local control can be turned off, however, so that the keyboard does not play the internal voices, but the appropriate MIDI information is still transmitted via the MIDI OUT connector when notes are played on the keyboard. At the same time, the internal tone generator can respond to MIDI information received on channels set to the “XG/GM” mode via the MIDI IN connector. This means that while an external MIDI sequencer, for example, plays the PSR-550 internal voices, an external tone generator can be played from the PSR-550 keyboard.

NOTE

- The default Local Control setting (factory setting) is “On”.

1 Press the [FUNCTION] button.

2 Select “Midi”.

Use the **data dial**, the [+ / YES] button or the [- / NO] button.

3 Press the [NEXT] button to display the MIDI screen.

4 Select “LocalContrl.”

Use the **data dial**, the [+ / YES] button or the [- / NO] button.

Midi : LocalContrl

5 Press the [NEXT] button to display the Local Control screen.

6 Turn the Local Control on or off.

Use the **data dial**, the [+ / YES] button or the [- / NO] button.

Midi Local =Off

Clock

Reception of an external MIDI clock signal can be enabled or disabled as required. When disabled (“Int”), all of the time-based functions (Auto Accompaniment, SONG recording and playback, etc.) are controlled by its own internal clock. When MIDI clock reception is enabled (“Ext”), however, all timing is controlled by an external MIDI clock signal received via the MIDI IN terminal (in this case the PSR-550 TEMPO setting has no effect). The default setting is “Int”.

1 Press the [FUNCTION] button.

2 Select “Midi.”

Use the **data dial**, the [+ / YES] button or the [- / NO] button.

3 Press the [NEXT] button to display the MIDI screen.

4 Select “Clock.”

Use the **data dial**, the [+ / YES] button or the [- / NO] button.

Midi # Clock

5 Press the [NEXT] button to display the Clock screen.

6 Set the Clock to “Int” or “Ext.”

Use the **data dial**, the [+ / YES] button or the [- / NO] button.

Midi Clock = Int

NOTE

- The default Clock setting (factory setting) is “Int.”
- When the Clock setting is “Ext,” auto accompaniment playback cannot be started via the panel [START/STOP] button. Also, Multi Pad playback cannot be initiated by pressing the any of the Multi Pads.
- When the Clock setting is “Ext,” “EC” will appear on the TEMPO display, and tempo cannot be changed with the panel button.

Initial Data Send

Transmits all current panel settings to a second PSR-550 or a MIDI data storage device.

If you want to have the song play back with the panel settings used for recording, execute the Initial Data Send function before recording the performance on the PSR-550 to an external sequencer.

1 Press the [FUNCTION] button.

2 Select “Midi.”

Use the **data dial**, the [+ / YES] button or the [- / NO] button.

3 Press the [NEXT] button to display the MIDI screen.

4 Select “Init Send.”

Use the **data dial**, the [+ / YES] button or the [- / NO] button.

Midi # Init Send

5 Press the [NEXT] button to display the Init Send screen.

6 Execute the Init Send operation.

Press the [+ / YES] button to execute the Init Send operation.

To abort the operation, press the [- / NO] button.

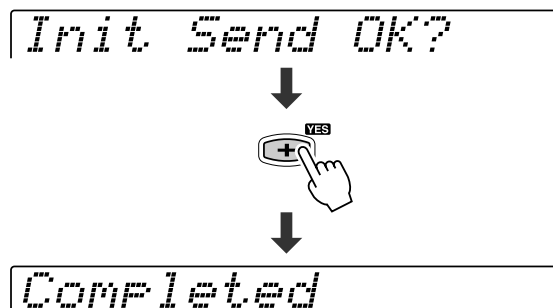

Other Functions (Utility)

This section of the manual covers some important functions of the PSR-550 that have not been explained in previous sections. These are all combined in the Utility menu of the “Function” section.

• Metronome	“Metronom”	page 118
• Upper Octave	“UpperOct”	page 119
• Master Tuning	“Tuning”	page 119
• Scale Tuning	“SC. Tune”	page 119
• Split Point	“Split”	page 120
• Fingering	“Fingerns”	page 38
• Touch Sensitivity	“TouchSns”	page 120
• Voice Set	“VoiceSet”	page 120
• Footswitch	“Pedal”	page 121
• Pitch Bend Range	“PitchBnd”	page 122
• Assignable	“Assignbl”	page 122
• Backlight	“BackLigt”	page 122

Each of the above functions can be set as described below.

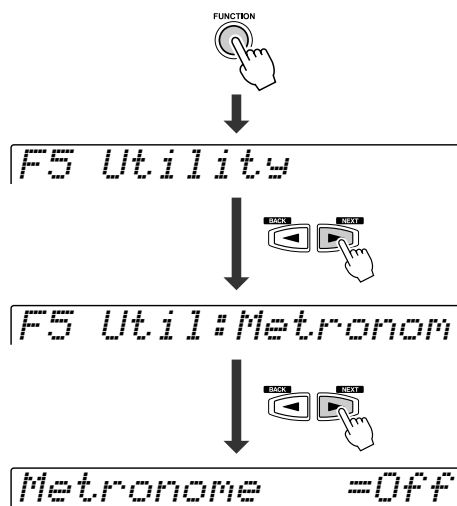

- 1 Press the [FUNCTION] button.
- 2 Select “Utility.”
Use the data dial, the [+ / YES] button or the [- / NO] button.
- 3 Press the [NEXT] button.
- 4 Select a function.
Use the data dial, the [+ / YES] button or the [- / NO] button.
Refer to the list above for available Utility menu items.
- 5 Press the [NEXT] button.
- 6 Set the value.
Use the data dial, the [+ / YES] button or the [- / NO] button.

The operations for each function corresponding to step #6 are covered in the following explanations.

Metronome

When this is set to “ON,” the metronome sounds at the set tempo for the following conditions.

- Accompaniment playback
- Song playback
- Synchronized start standby
- Record standby
- Recording

Metronome =On

- Turn Metronome ON or OFF with the **data dial**, the [+ / YES] button or the [- / NO] button.

NOTE

- The Metronome cannot be turned on when free-tempo song data is selected in the Song mode.

The tempo setting of some commercially available songs is fixed. These songs are called “free-tempo” software. When playing back free-tempo song data on the PSR-550, the Tempo display shows “- - -” and the beat display does not flash. Also, the measure number in the display does not match the actual measure number of playback, and only gives you an indication of how much of the song has played back.

Upper Octave

This determines the Octave setting for the right-hand range of the keyboard, letting you have independent ranges for the right and left hands. The range is from -1 to 1.

Upper Octave = 1

- Use the data dial, the [+ / YES] button or the [- / NO] button to set the Octave.

Master Tuning

The Master Tuning function sets the overall pitch of the PSR-550. The range is from 414.6 Hz to 466.8 Hz.

Tuning = 414.6

- Set the value with the **data dial**, the [+ / YES] button or the [- / NO] button.

Scale Tuning

Scale tuning allows each individual note of the octave to be tuned over range from -64 to +63 cents in 1-cent increments (1 cent = 1/100th of a semitone). This makes it possible to produce subtle tuning variations, or tune the instrument to totally different scales (e.g. classic or Arabic scales).

The PSR-550 also provides nine different scale settings (shown below) that let you instantly reconfigure the tuning of the instrument for playing in special scales. You can tune the instrument in two ways: select the desired scale setting template, or tune each key individually using Note Edit.

Template	C	C#	D	E \flat	E	F	F#	G	A \flat	A	B \flat	B
Bayat-G	0	0	0	0	-50	0	0	0	0	-50	0	0
Bayat-A	0	0	0	0	0	0	-50	0	0	0	0	-50
Bayat-E	0	-50	0	0	0	0	-50	0	0	0	0	0
Bayat-C	0	0	-50	0	0	0	0	0	0	-50	0	0
Rast-G	0	0	0	0	0	0	-50	0	0	0	0	-50
Rast-A	0	-50	0	0	0	0	0	0	-50	0	0	0
Rast-E	0	0	0	-50	0	0	0	0	-50	0	0	0
Rast-C	0	0	0	0	-50	0	0	0	0	0	0	-50
Equal	0	0	0	0	0	0	0	0	0	0	0	0

NOTE

- The scale tuning settings are common to each octave on the keyboard.
- Minus values can be entered by using the number buttons while holding the [- / NO] button.

NOTE

- The normal tuning of ± 0 cents can be recalled by setting "Equal".

Use the same operation as in steps 1-5 on page 118 and:

- Selecting the template

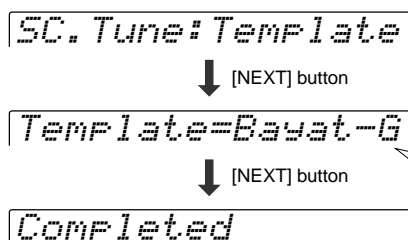

- Individual note tuning

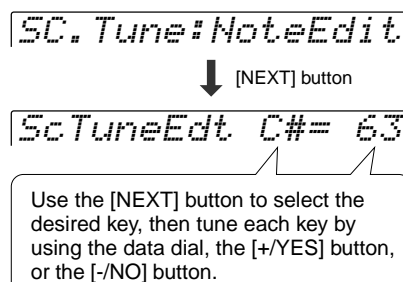

↔ Data dial
[+ / YES] button
[- / NO] button

Use the data dial, the [+ / YES] button or the [- / NO] button to select the template. For details, refer to the table above.

Split Point

The point on the keyboard that separates the auto accompaniment section and the right-hand section of the keyboard is called the “split point.”

- When the auto accompaniment is on, keys played to the left of the split point are used for controlling the auto accompaniment (page 33).
- When the auto accompaniment is off, keys played to the left of the split point are used for playing voice L (page 28).

NOTE

- The default setting (factory setting) is “F#2.”

Split Point =C3

- Set the value with the **data dial**, the [+/**YES**] button or the [-/**NO**] button.

Touch Sensitivity

The keyboard of the PSR-550 is equipped with a touch response feature that lets you dynamically and expressively control the level of the voices with your playing strength — just as on an acoustic instrument. The Touch Sensitivity parameter gives you detailed control over the touch response feature by letting you set the degree of touch response.

Touch Sense =127

- Set the value with the **data dial**, the [+/**YES**] button, the [-/**NO**] button or the number buttons [1]-[0].

The range is from 0 to 127. The greater the value, the more sensitive the keyboard is to your playing strength, and the more dynamic range that can be brought out of the voices.

A setting of “0” results in a fixed touch response, or no level change no matter how hard or how soft you play the keys. (This setting is good for instrument sounds such as organ or harpsichord, which normally do not have touch response.) You can also achieve the same effect by turning touch response off with the [**TOUCH**] button on the panel (the indicator turns off).



Voice Set

The Voice Set feature brings out the best in each individual voice by automatically setting a range of important voice-related parameters whenever an R1 panel voice is selected. The parameters that may be set by the Voice Set feature are listed below. This function lets you turn Voice Set on or off, as required.

● **Voice Set Parameter List**

- Voice R1 (Volume, octave, pan, reverb depth, chorus depth, DSP depth)
- Voice R2 (Voice number, volume, octave, pan, reverb depth, chorus depth, DSP depth)
- Harmony Type, Volume, Part setting
- DSP on/off, type, return level and FAST/SLOW

Voice Set =On

- Turn Voice Set On or Off by using the **data dial**, the [+/**YES**] button or the [-/**NO**] button.

Footswitch

Various functions can be assigned to the footswitch connected to the FOOTSWITCH jack. The polarity of the footswitch can also be changed.

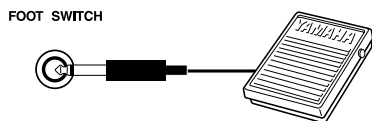

- Select the Functions to be controlled by the footswitch.

Ped1=Sustain

↓ Press the [NEXT] button.

Use the data dial, the [+ / YES] button or the [- / NO] button.

- Set the polarity of the footswitch NORMAL or REVERSE.

Polarity = Norm

Use the data dial, the [+ / YES] button or the [- / NO] button.

● Functions controlled by the footswitch

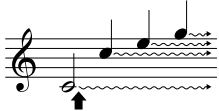
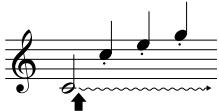
Sustain	When you press the footswitch, sustain is applied to the keyboard notes.	
Sostenuto	When you press the footswitch, the sostenuto effect is applied to the keyboard notes.	
Soft	When you press the footswitch, the soft effect is applied to the keyboard notes.	
Regist +	Pressing the footswitch advances through the Registration Memory numbers. For example, if you step on the footswitch with bank 1-3 recalled, 1-4 will be recalled, then next 2-1 will be recalled.	
Start/Stop	Pressing the footswitch has the same effect as pressing the START/STOP button on the panel.	
Synchro Stop	Pressing the footswitch has the same effect as pressing the SYNC STOP button on the panel.	
Bass Hold	The bass root note will be held as long as you press the footswitch.	
Break	When you press the footswitch, accompaniment will stop. Releasing the switch with the foot will cause it to play again from the next measure.	
Tap Tempo	Pressing the footswitch has the same effect as pressing the TAP TEMPO button on the panel.	

For "Sustain," if you press and hold the footswitch here, all the notes shown will be sustained.

For "Sostenuto," if you press and hold the footswitch here, only the first note will be sustained (the note that you played and held when pressing the footswitch).

NOTE

- When the footswitch changes the Registration Memory number (Regist +), the footswitch function set in the selected Registration Memory is overridden or ignored. For example, even if footswitch is set to control Sustain in the selected Registration Memory, if set to "Regist +" here, the footswitch will NOT control Sustain.

● Polarity

This parameter lets you configure the footswitch response of the PSR-550 to match that of the particular footswitch you are using. If the footswitch works in the opposite way (i.e., pressing the footswitch has no effect, but releasing it does), try changing this setting. The default setting is "Norm."

Pitch Bend Range

This determines the maximum pitch bend range for the **PITCH BEND** wheel. The range is from “0” to “12”. Each increment corresponds to one semitone.

PitchBndRange = 4

- Set the Pitch Bend Range with the **data dial**, the [+/**YES**] button, the [-/**NO**] button or the number buttons [1]-[0].

Assignable

Functions to be called up via the Direct Access can be assigned to the [+/**YES**] button, [-/**NO**] button and the number buttons [1]-[0]. See the function tree chart for details (page 22-23).

AssignButton = 1

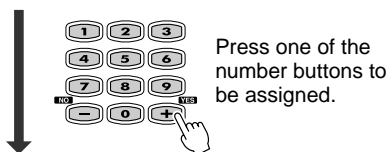

AssignButton = +

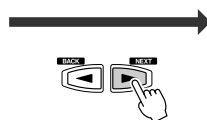

Ass=HarmPart

Select the function/parameter you wish to assign by using the data dial, the [+/**YES**] button, or the [-/**NO**] button.

● Another way to set the Direct Access:

- 1 Select the function or parameter you wish to assign. See the function tree chart for details (page 22-23).
- 2 While holding the [MEMORY] button, press one of the number buttons.

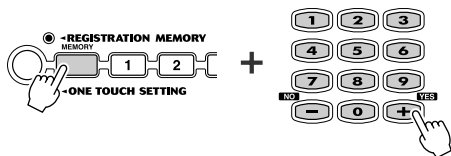

In this example, “Clock = Int” is assigned to the [+]**YES** button.

Backlight

You can set the Backlight color of the display. Use the **data dial**, the [+/**YES**] button or the [-/**NO**] button to set the Backlight color.

BackLight=Auto

- **Auto** The color changes according to the mode of the PSR-550. In the Style mode, the backlight color is set to blue. In the Song mode, the backlight color is set to purple. In the Record mode, the backlight color is set to red.
- **Blue, Red, Purple** The backlight color is not changed regardless of the mode.
- **Off** The backlight color is turned off.

PSR-550 Voices

The PSR-550 actually includes two voice sets: the "panel" voices and percussion kits, and the XG voices. The panel voices include 219 "pitched" voices and 14 drum kits, while the XG voice set includes 480 voices.

The panel voices are specially recorded and programmed voices exclusive to the PSR-550 and other PortaTone instruments. The XG voices conform to Yamaha's XG format; they also conform to the GM (General MIDI) standard. This allows you to accurately play back any GM- or XG-compatible song data directly on the PSR-550 itself, without having to change voices or make special settings. It also allows you to record songs for other GM- or XG-compatible instruments, and have them play back on those instruments as intended.

● Voices

	Panel Voices	Drum Kits (Panel Voices)	XG Voices
PSR-550	001-219	220-233	234-713

● Maximum Polyphony

The PSR-550 has 32-note maximum polyphony. Auto Accompaniment uses a number of the available notes, so when Auto Accompaniment is used the total number of notes that can be played on the keyboard is correspondingly reduced. The same applies to the Voice R2, Voice L, Multi Pad, and Song functions. When the maximum polyphony is exceeded, notes are played using last-note priority.

NOTE

- The Voice List includes MIDI program change numbers for each voice. Use these program change numbers when playing the PSR-550 via MIDI from an external device.
- When the sustain or sostenuto pedal functions are being used (page 121), some voices may sound continuously or have a long decay after the notes have been released while the pedal is held.

Panel Voice List

Voice Number	Bank Select		MIDI Program Change Number	Voice Name	Number of Notes Used
	MSB	LSB			
Piano					
1	0	112	1	Grand Piano	2
2	0	112	2	Bright Piano	2
3	0	112	4	Honky Tonk	2
4	0	114	3	Rock Piano	2
5	0	112	3	Midi Grand	2
6	0	113	3	CP 80	2
7	0	112	7	Harpsichord	1
8	0	113	7	Grand Harpsi	2
E.Piano					
9	0	114	5	Galaxy EP	2
10	0	115	5	Polaris EP	2
11	0	118	5	Suitcase EP	2
12	0	117	6	Super DX EP	2
13	0	112	6	DX Modern EP	2
14	0	112	5	Funk EP	1
15	0	115	6	Modern EP	2
16	0	113	6	Hyper Tines	2
17	0	116	6	New Tines	2
18	0	114	6	Venus EP	2
19	0	113	5	Tremolo EP	2
20	0	112	8	Clavi	1
21	0	113	8	Wah Clavi	1
Organ					
22	0	112	17	Jazz Organ1	2
23	0	113	17	Jazz Organ2	2
24	0	120	17	GlassJazzOrg	2
25	0	112	18	Click Organ	2
26	0	113	18	Dance Organ	2
27	0	115	17	DrawbarOrgan	2
28	0	115	18	Mellow Draw	2
29	0	116	17	Bright Draw	2
30	0	112	19	Rock Organ 1	2
31	0	113	19	Rock Organ 2	2
32	0	114	19	Purple Organ	2
33	0	116	18	60's Organ	2
34	0	117	18	Blues Organ	2
35	0	117	17	16+1 Organ	2
36	0	118	17	16+2 Organ	2
37	0	119	17	16+4 Organ	2
38	0	118	18	Elec.Organ	2
39	0	114	17	TheaterOrg1	2
40	0	114	18	TheaterOrg2	2
41	0	112	20	Pipe Organ	2

Voice Number	Bank Select		MIDI Program Change Number	Voice Name	Number of Notes Used
	MSB	LSB			
42	0	113	20	ChapelOrgan1	2
43	0	114	20	ChapelOrgan2	2
44	0	115	20	ChapelOrgan3	2
45	0	112	21	Reed Organ	1
Accordion					
46	0	113	22	Trad.Accrd	2
47	0	112	22	MusetteAccrd	2
48	0	112	24	Tango Accrd	1
49	0	113	24	Bandoneon	2
50	0	114	22	Soft Accrd	2
51	0	115	22	Accordion	1
52	0	112	23	Harmonica	1
Guitar					
53	0	113	25	Spanish Gtr	1
54	0	112	25	Classic Gtr	2
55	0	112	26	Folk Guitar	1
56	0	116	26	FolkGw/pick1	2
57	0	117	26	FolkGw/pick2	2
58	0	118	26	FolkGw/pick3	2
59	0	113	26	12Str Guitar	2
60	0	114	25	Smooth Nylon	2
61	0	115	26	Campfire	2
62	0	112	27	Jazz Guitar	2
63	0	113	27	Octave Gtr	2
64	0	114	27	Hawaiian Gtr	2
65	0	123	28	VintageOpen	1
66	0	124	28	VintageChors	2
67	0	118	28	Solid Guitar	2
68	0	116	28	Bright Clean	1
69	0	112	28	Clean Guitar	2
70	0	119	28	Elec12StrGtr	2
71	0	113	28	Tremolo Gtr	2
72	0	114	29	Cool! E.Gtr	1
73	0	115	29	VintageMute	1
74	0	113	29	Funk Guitar	1
75	0	112	29	Muted Guitar	1
76	0	113	30	Feedback Gtr	2
77	0	112	30	Overdriven	2
78	0	112	31	Distortion	2
79	0	115	28	Pedal Steel	2
80	0	114	26	Mandolin	2
Bass					
81	0	112	34	Finger Bass	1
82	0	112	33	AcousticBass	2

Voice List

Voice Number	Bank Select		MIDI Program Change Number	Voice Name	Number of Notes Used
	MSB	LSB			
83	0	114	33	Bass&Cymbal	2
84	0	112	35	Pick Bass	1
85	0	112	36	FretlessBass	2
86	0	113	36	Jaco Bass	2
87	0	112	37	Slap Bass	1
88	0	112	38	Funk Bass	1
89	0	113	37	Fusion Bass	1
90	0	112	39	Synth Bass	1
91	0	112	40	Analog Bass	2
92	0	113	40	Dance Bass	2
93	0	113	39	Hi-Q Bass	2
94	0	114	39	Rave Bass	2
Strings					
95	0	112	49	String Ensbl	2
96	0	113	49	Orch.Strings	2
97	0	114	49	SymphonicStr	2
98	0	113	50	Slow Strings	2
99	0	114	50	Str.Quartet	2
100	0	115	49	Concerto Str	2
101	0	115	50	Marcato Strs	2
102	0	112	50	Chamber Strs	2
103	0	112	45	Tremolo Strs	2
104	0	112	46	Pizz.Strings	2
105	0	112	51	Syn Strings	2
106	0	112	52	Analog Strs	2
107	0	113	51	Tech Strings	2
108	0	112	56	OrchestraHit	2
109	0	112	41	Solo Violin	2
110	0	113	41	Soft Violin	1
111	0	112	111	Fiddle	1
112	0	112	42	Viola	2
113	0	112	43	Cello	1
114	0	112	44	Contrabass	1
115	0	112	47	Harp	2
116	0	113	47	Hackbrett	2
117	0	112	107	Shamisen	1
118	0	112	108	Koto	1
119	0	112	105	Sitar	2
120	0	112	106	Banjo	1
Choir					
121	0	112	53	Choir	2
122	0	112	55	Air Choir	2
123	0	113	54	Gothic Vox	2
124	0	113	53	Vocal Ensbl	2
125	0	112	54	Vox Humana	2
Trumpet					
126	0	115	57	SweetTrumpet	1
127	0	112	57	Solo Trumpet	1
128	0	114	57	Soft Trumpet	1
129	0	113	57	Flugel Horn	1
130	0	112	60	MutedTrumpet	1
131	0	112	58	Trombone	1
132	0	114	58	Mel.Trombone	2
133	0	112	61	French Horn	1
134	0	112	59	Tuba	2
Brass					
135	0	113	62	BigBandBrass	2
136	0	112	62	BrassSection	2
137	0	116	62	Mellow Brass	2
138	0	117	62	Small Brass	2
139	0	118	62	Pop Brass	2
140	0	119	62	Mellow Horns	2
141	0	113	60	Ballroom Brs	2
142	0	114	62	Full Horns	2

Voice Number	Bank Select		MIDI Program Change Number	Voice Name	Number of Notes Used
	MSB	LSB			
143	0	115	62	High Brass	2
144	0	120	62	Bright Brass	2
145	0	113	58	Trb.Section	2
146	0	112	63	Synth Brass	2
147	0	112	64	Analog Brass	2
148	0	113	63	Jump Brass	2
149	0	114	63	Techno Brass	2
Saxophone					
150	0	117	67	Sweet Tenor	2
151	0	114	67	BreathyTenor	2
152	0	113	66	Breathy Alto	2
153	0	112	65	Soprano Sax	2
154	0	112	66	Alto Sax	1
155	0	112	67	Tenor Sax	1
156	0	112	68	Baritone Sax	1
157	0	116	67	Sax Section	2
158	0	115	67	Sax Combo	2
159	0	112	72	Clarinet	2
160	0	113	72	Mel.Clarinet	2
161	0	113	67	Woodwind Ens	2
162	0	112	69	Oboe	1
163	0	112	70	English Horn	1
164	0	112	71	Bassoon	1
Flute					
165	0	114	74	Sweet Flute	1
166	0	112	74	Flute	2
167	0	113	74	Pan Flute	2
168	0	112	73	Piccolo	1
169	0	112	76	Ethnic Flute	2
170	0	112	78	Shakuhachi	1
171	0	112	79	Whistle	1
172	0	112	75	Recorder	1
173	0	112	80	Ocarina	1
174	0	112	110	Bagpipe	2
Synth Lead					
175	0	116	82	Fire Wire	2
176	0	112	81	Square Lead	2
177	0	112	82	SawtoothLead	2
178	0	113	82	Big Lead	2
179	0	112	99	Stardust	2
180	0	114	82	Blaster	2
181	0	115	82	Analogon	2
182	0	113	99	Sun Bell	2
183	0	112	84	Aero Lead	2
184	0	114	81	Mini Lead	2
185	0	115	81	Vinylead	1
186	0	117	82	Warp	2
187	0	116	81	Hi Bias	2
188	0	118	81	Tiny Lead	2
189	0	118	82	Sub Aqua	2
190	0	119	82	Fargo	2
Synth Pad					
191	0	113	95	Insomnia	2
192	0	115	89	Golden Age	2
193	0	113	100	Cyber Pad	2
194	0	112	96	Wave 2001	2
195	0	112	95	Equinox	2
196	0	114	89	Stargate	2
197	0	112	93	DX Pad	2
198	0	112	89	Fantasia	2
199	0	112	92	Xenon Pad	2
200	0	112	90	Area 51	2
201	0	112	100	AtmospherPad	2
202	0	113	90	Dark Moon	2

Voice Number	Bank Select		MIDI Program Change Number	Voice Name	Number of Notes Used
	MSB	LSB			
203	0	115	95	Ionosphere	2
204	0	113	89	Symbiont	2
205	0	114	95	Solaris	2
206	0	117	89	Millenium	2
207	0	113	96	Transform	2
Percussion					
208	0	113	12	Jazz Vibes	2
209	0	112	12	Vibraphone	2
210	0	112	13	Marimba	2
211	0	112	14	Xylophone	1
212	0	112	115	Steel Drums	1
213	0	112	9	Celesta	2
214	0	112	10	Glockenspiel	1
215	0	112	11	Music Box	2
216	0	112	15	Tubular Bell	2
217	0	112	109	Kalimba	1
218	0	112	48	Timpani	1
219	0	112	16	Dulcimer	2

Voice Number	Bank Select		MIDI Program Change Number	Voice Name	Number of Notes Used
	MSB	LSB			
Drum Kits					
220	127	0	1	StandardKit1	-
221	127	0	2	StandardKit2	-
222	127	0	9	Room Kit	-
223	127	0	17	Rock Kit	-
224	127	0	25	Electro Kit	-
225	127	0	26	Analog Kit	-
226	127	0	28	Dance Kit	-
227	127	0	33	Jazz Kit	-
228	127	0	41	Brush Kit	-
229	127	0	49	Symphony Kit	-
230	127	0	81	Style Kit	-
231	126	0	36	ArabicKit	-
232	126	0	1	SFX Kit 1	-
233	126	0	2	SFX Kit 2	-

XG Voice List

Voice Number	Bank Select		MIDI Program Change Number	Voice Name	Number of Notes Used
	MSB	LSB			
234	0	0	1	Grand Piano	1
235	0	1	1	GrndPianoKSP	1
236	0	18	1	MellowGrPno	1
237	0	40	1	PianoStrings	2
238	0	41	1	Dream	2
239	0	0	2	Bright Piano	1
240	0	1	2	BritePnoKSP	1
241	0	0	3	ElecGrandPno	2
242	0	1	3	ElecGrPnoKSP	2
243	0	32	3	Detuned CP80	2
244	0	40	3	Layered CP 1	2
245	0	41	3	Layered CP 2	2
246	0	0	4	Honkytonk	2
247	0	1	4	HonkytonkKSP	2
248	0	0	5	EI.Piano 1	2
249	0	1	5	EI.Piano1KSP	1
250	0	18	5	Mellow EP 1	2
251	0	32	5	Chorus EP 1	2
252	0	40	5	HardEI.Piano	2
253	0	45	5	VXfade EI.P1	2
254	0	64	5	60sEI.Piano1	1
255	0	0	6	EI.Piano 2	2
256	0	1	6	EI.Piano2KSP	1
257	0	32	6	Chorus EP 2	2
258	0	33	6	DX EP Hard	2
259	0	34	6	DX Legend	2
260	0	40	6	DX Phase EP	2
261	0	41	6	DX+AnalogEP	2
262	0	42	6	DX Koto EP	2
263	0	45	6	VXfade EI.P1	2
264	0	0	7	Harpsichord	1
265	0	1	7	Harpsi.KSP	1
266	0	25	7	Harpsichord2	2
267	0	35	7	Harpsichord3	2
268	0	0	8	Clavi.	1
269	0	1	8	Clavi.KSP	1
270	0	27	8	Clavi.Wah	2
271	0	64	8	Pulse Clavi.	1

Voice Number	Bank Select		MIDI Program Change Number	Voice Name	Number of Notes Used
	MSB	LSB			
272	0	65	8	PierceClavi.	2
273	0	0	9	Celesta	1
274	0	0	10	Glockenspiel	1
275	0	0	11	Music Box	2
276	0	64	11	Orgel	2
277	0	0	12	Vibraphone	1
278	0	1	12	Vibes KSP	1
279	0	45	12	Hard Vibes	2
280	0	0	13	Marimba	1
281	0	1	13	Marimba KSP	1
282	0	64	13	Sine Marimba	2
283	0	97	13	Balimba	2
284	0	98	13	Log Drums	2
285	0	0	14	Xylophone	1
286	0	0	15	TubularBells	1
287	0	96	15	Church Bells	2
288	0	97	15	Carillon	2
289	0	0	16	Dulcimer	1
290	0	35	16	Dulcimer 2	2
291	0	96	16	Cimbalom	2
292	0	97	16	Santur	2
293	0	0	17	DrawbarOrgan	1
294	0	32	17	DetDrawOrgan	2
295	0	33	17	60sDrawOrg1	2
296	0	34	17	60sDrawOrg2	2
297	0	35	17	70sDrawOrg1	2
298	0	36	17	DrawbarOrg2	2
299	0	37	17	60sDrawOrg3	2
300	0	38	17	Even Bar Org	2
301	0	40	17	16+2'2/3 Org	2
302	0	64	17	Organ Bass	1
303	0	65	17	70sDrawOrg2	2
304	0	66	17	Cheezy Organ	2
305	0	67	17	DrawbarOrg3	2
306	0	0	18	Perc.Organ	1
307	0	24	18	70sPercOrg1	2
308	0	32	18	DetPercOrgan	2
309	0	33	18	Light Organ	2

Voice Number	Bank Select		MIDI Program Change Number	Voice Name	Number of Notes Used
	MSB	LSB			
310	0	37	18	Perc.Organ2	2
311	0	0	19	Rock Organ	1
312	0	64	19	Rotary Organ	2
313	0	65	19	Slow Rotary	2
314	0	66	19	Fast Rotary	2
315	0	0	20	Church Organ	2
316	0	32	20	ChurchOrgan3	2
317	0	35	20	ChurchOrgan2	2
318	0	40	20	Notre Dame	2
319	0	64	20	Organ Flute	2
320	0	65	20	Trem.OrganFl	2
321	0	0	21	Reed Organ	1
322	0	40	21	Puff Organ	2
323	0	0	22	Accordion	1
324	0	32	22	Accord It	2
325	0	0	23	Harmonica	1
326	0	32	23	Harmonica 2	2
327	0	0	24	Tango Accord	1
328	0	64	24	TangoAccord2	2
329	0	0	25	Nylon Guitar	1
330	0	16	25	NylonGuitar2	1
331	0	25	25	NylonGuitar3	2
332	0	43	25	VelGtrHarmo	1
333	0	96	25	Ukulele	1
334	0	0	26	Steel Guitar	1
335	0	16	26	SteelGuitar2	1
336	0	35	26	12Str Guitar	2
337	0	40	26	Nylon&Steel	2
338	0	41	26	Steel&Body	2
339	0	96	26	Mandolin	2
340	0	0	27	Jazz Guitar	1
341	0	18	27	MellowGuitar	1
342	0	32	27	Jazz Amp	2
343	0	0	28	Clean Guitar	1
344	0	32	28	ChorusGuitar	2
345	0	0	29	Muted Guitar	1
346	0	40	29	FunkGuitar1	2
347	0	41	29	MuteSteelGtr	2

Voice List

Voice Number	Bank Select		MIDI Program Change Number	Voice Name	Number of Notes Used
	MSB	LSB			
348	0	43	29	FunkGuitar2	1
349	0	45	29	Jazz Man	2
350	0	0	30	Overdriven	1
351	0	43	30	Guitar Pinch	1
352	0	0	31	Distortion	1
353	0	40	31	FeedbackGtr	2
354	0	41	31	FeedbackGtr2	2
355	0	0	32	GtrHarmonics	1
356	0	65	32	GtrFeedback	1
357	0	66	32	GtrHarmonic2	1
358	0	0	33	AcousticBass	1
359	0	40	33	Jazz Rhythm	2
360	0	45	33	VXUprghtBass	2
361	0	0	34	Finger Bass	1
362	0	18	34	Finger Dark	2
363	0	27	34	Flange Bass	2
364	0	40	34	Bass&DistEG	2
365	0	43	34	Finger Slap	1
366	0	45	34	FingerBass2	2
367	0	65	34	Mod.Bass	2
368	0	0	35	Pick Bass	1
369	0	28	35	MutePickBass	1
370	0	0	36	FretlessBass	1
371	0	32	36	Fretless 2	2
372	0	33	36	Fretless 3	2
373	0	34	36	Fretless 4	2
374	0	96	36	Syn.Fretless	2
375	0	97	36	SmthFretless	2
376	0	0	37	Slap Bass 1	1
377	0	27	37	ResonantSlap	1
378	0	32	37	Punch Thumb	2
379	0	0	38	Slap Bass 2	1
380	0	43	38	Velo.Sw.Slap	1
381	0	0	39	Synth Bass 1	1
382	0	18	39	SynBass1Dark	1
383	0	20	39	FastResoBass	1
384	0	24	39	Acid Bass	1
385	0	35	39	Clavi Bass	2
386	0	40	39	Techno Bass	2
387	0	64	39	Orbiter	2
388	0	65	39	Square Bass	1
389	0	66	39	Rubber Bass	2
390	0	96	39	Hammer	2
391	0	0	40	Synth Bass 2	2
392	0	6	40	MellowSyBass	1
393	0	12	40	SequenceBass	2
394	0	18	40	ClickSynBass	2
395	0	19	40	SynBass2Dark	1
396	0	32	40	SmoothSyBass	2
397	0	40	40	ModulrSyBass	2
398	0	41	40	DX Bass	2
399	0	64	40	X Wire Bass	2
400	0	0	41	Violin	1
401	0	8	41	SlwAtkViolin	1
402	0	0	42	Viola	1
403	0	0	43	Cello	1
404	0	0	44	Contrabass	1
405	0	0	45	Trem.Strings	1
406	0	8	45	SlwAtTremStr	1
407	0	40	45	SuspenseStr	2
408	0	0	46	PizzicatoStr	1
409	0	0	47	Orch.Harp	1
410	0	40	47	Yang Chin	2
411	0	0	48	Timpani	1

Voice Number	Bank Select		MIDI Program Change Number	Voice Name	Number of Notes Used
	MSB	LSB			
412	0	0	49	Strings 1	1
413	0	3	49	StereoStrngs	2
414	0	8	49	SlwAtkStrngs	1
415	0	24	49	Arco Strings	2
416	0	35	49	60's Strings	2
417	0	40	49	Orchestra	2
418	0	41	49	Orchestra 2	2
419	0	42	49	TremOrchestra	2
420	0	45	49	Velo.Strings	2
421	0	0	50	Strings 2	1
422	0	3	50	S.SlowStrngs	2
423	0	8	50	LegatoStrngs	2
424	0	40	50	Warm Strings	2
425	0	41	50	Kingdom	2
426	0	64	50	70's Strings	1
427	0	65	50	Strings 3	1
428	0	0	51	SynStrings1	2
429	0	27	51	Reso Strings	2
430	0	64	51	SynStrings4	2
431	0	65	51	SynStrings5	2
432	0	0	52	SynStrings2	2
433	0	0	53	Choir Aahs	1
434	0	3	53	Stereo Choir	2
435	0	16	53	Choir Aahs 2	2
436	0	32	53	Mellow Choir	2
437	0	40	53	ChoirStrings	2
438	0	0	54	Voice Oohs	1
439	0	0	55	Synth Voice	1
440	0	40	55	SynthVoice2	2
441	0	41	55	Choral	2
442	0	64	55	Analog Voice	1
443	0	0	56	OrchestraHit	2
444	0	35	56	OrchestrHit2	2
445	0	64	56	Impact	2
446	0	0	57	Trumpet	1
447	0	16	57	Trumpet 2	1
448	0	17	57	BriteTrumpet	2
449	0	32	57	Warm Trumpet	2
450	0	0	58	Trombone	1
451	0	18	58	Trombone 2	2
452	0	0	59	Tuba	1
453	0	16	59	Tuba 2	1
454	0	0	60	MutedTrumpet	1
455	0	0	61	French Horn	1
456	0	6	61	Fr.Horn Solo	1
457	0	32	61	FrenchHorn2	2
458	0	37	61	HornOrchestr	2
459	0	0	62	BrassSection	1
460	0	35	62	Tp&TbSection	2
461	0	40	62	BrassSect2	2
462	0	41	62	High Brass	2
463	0	42	62	Mellow Brass	2
464	0	0	63	SynthBrass1	2
465	0	12	63	Quack Brass	2
466	0	20	63	ResoSynBrass	2
467	0	24	63	Poly Brass	2
468	0	27	63	SynthBrass3	2
469	0	32	63	Jump Brass	2
470	0	45	63	AnaVelBrass1	2
471	0	64	63	AnalogBrass1	2
472	0	0	64	SynthBrass2	1
473	0	18	64	Soft Brass	2
474	0	40	64	SynthBrass4	2
475	0	41	64	Choir Brass	2

Voice Number	Bank Select		MIDI Program Change Number	Voice Name	Number of Notes Used
	MSB	LSB			
476	0	45	64	AnaVelBrass2	2
477	0	64	64	AnalogBrass2	2
478	0	0	65	Soprano Sax	1
479	0	0	66	Alto Sax	1
480	0	40	66	Sax Section	2
481	0	43	66	HyperAltoSax	1
482	0	0	67	Tenor Sax	1
483	0	40	67	BreathyTenor	2
484	0	41	67	SoftTenorSax	2
485	0	64	67	Tenor Sax2	1
486	0	0	68	Baritone Sax	1
487	0	0	69	Oboe	1
488	0	0	70	English Horn	1
489	0	0	71	Bassoon	1
490	0	0	72	Clarinet	1
491	0	0	73	Piccolo	1
492	0	0	74	Flute	1
493	0	0	75	Recorder	1
494	0	0	76	Pan Flute	1
495	0	0	77	Blown Bottle	2
496	0	0	78	Shakuhachi	1
497	0	0	79	Whistle	1
498	0	0	80	Ocarina	1
499	0	0	81	Square Lead	2
500	0	6	81	SquareLead2	1
501	0	8	81	LM Square	2
502	0	18	81	Hollow	1
503	0	19	81	Shroud	2
504	0	64	81	Mellow	2
505	0	65	81	Solo Sine	2
506	0	66	81	Sine Lead	1
507	0	0	82	SawtoothLead	2
508	0	6	82	SawtoothLd2	1
509	0	8	82	Thick Saw	2
510	0	18	82	Dynamic Saw	1
511	0	19	82	Digital Saw	2
512	0	20	82	Big Lead	2
513	0	24	82	Heavy Synth	2
514	0	25	82	Waspy Synth	2
515	0	40	82	Pulse Saw	2
516	0	41	82	Dr. Lead	2
517	0	45	82	VelocityLead	2
518	0	96	82	Seq.Analog	2
519	0	0	83	CalliopeLead	2
520	0	65	83	Pure Pad	2
521	0	0	84	Chiff Lead	2
522	0	64	84	Rubby	2
523	0	0	85	Charang Lead	2
524	0	64	85	DistortedLd	2
525	0	65	85	Wire Lead	2
526	0	0	86	Voice Lead	2
527	0	24	86	Synth Aahs	2
528	0	64	86	Vox Lead	2
529	0	0	87	Fifths Lead	2
530	0	35	87	Big Five	2
531	0	0	88	Bass & Lead	2
532	0	16	88	Big & Low	2
533	0	64	88	Fat & Perky	2
534	0	65	88	Soft Whirl	2
535	0	0	89	New Age Pad	2
536	0	64	89	Fantasy	2
537	0	0	90	Warm Pad	2
538	0	16	90	Thick Pad	2
539	0	17	90	Soft Pad	2

Voice Number	Bank Select		MIDI Program Change Number	Voice Name	Number of Notes Used
	MSB	LSB			
540	0	18	90	Sine Pad	2
541	0	64	90	Horn Pad	2
542	0	65	90	RotaryStrngs	2
543	0	0	91	PolySynthPad	2
544	0	64	91	Poly Pad 80	2
545	0	65	91	Click Pad	2
546	0	66	91	Analog Pad	2
547	0	67	91	Square Pad	2
548	0	0	92	Choir Pad	2
549	0	64	92	Heaven	2
550	0	66	92	Itopia	2
551	0	67	92	CC Pad	2
552	0	0	93	Bowed Pad	2
553	0	64	93	Glacier	2
554	0	65	93	Glass Pad	2
555	0	0	94	Metallic Pad	2
556	0	64	94	Tine Pad	2
557	0	65	94	Pan Pad	2
558	0	0	95	Halo Pad	2
559	0	0	96	Sweep Pad	2
560	0	20	96	Shwimmer	2
561	0	27	96	Converge	2
562	0	64	96	Polar Pad	2
563	0	66	96	Celestial	2
564	0	0	97	Rain	2
565	0	45	97	Clavi Pad	2
566	0	64	97	Harmo Rain	2
567	0	65	97	African Wind	2
568	0	66	97	Carib	2
569	0	0	98	Sound Track	2
570	0	27	98	Prologue	2
571	0	64	98	Ancestral	2
572	0	0	99	Crystal	2
573	0	12	99	SynthDr.Comp	2
574	0	14	99	Popcorn	2
575	0	18	99	Tiny Bells	2
576	0	35	99	RoundGlocken	2
577	0	40	99	GlockenChime	2
578	0	41	99	Clear Bells	2
579	0	42	99	Chorus Bells	2
580	0	64	99	Synth Mallet	1
581	0	65	99	Soft Crystal	2
582	0	66	99	Loud Glocken	2
583	0	67	99	ChristmasBel	2
584	0	68	99	Vibe Bells	2
585	0	69	99	DigitalBells	2
586	0	70	99	Air Bells	2
587	0	71	99	Bell Harp	2
588	0	72	99	Gamelimba	2
589	0	0	100	Atmosphere	2
590	0	18	100	Warm Atmos.	2
591	0	19	100	HollwRelease	2
592	0	40	100	NylonEIPiano	2
593	0	64	100	Nylon Harp	2
594	0	65	100	Harp Vox	2
595	0	66	100	Atmos.Pad	2
596	0	67	100	Planet	2
597	0	0	101	Brightness	2
598	0	64	101	FantasyBells	2
599	0	96	101	Smokey	2
600	0	0	102	Goblins	2
601	0	64	102	GoblinsSynth	2
602	0	65	102	Creeper	2
603	0	66	102	Ring Pad	2

Voice Number	Bank Select		MIDI Program Change Number	Voice Name	Number of Notes Used
	MSB	LSB			
604	0	67	102	Ritual	2
605	0	68	102	To Heaven	2
606	0	70	102	Night	2
607	0	71	102	Glisten	2
608	0	96	102	Bell Choir	2
609	0	0	103	Echoes	2
610	0	8	103	Echoes2	2
611	0	14	103	Echo Pan	2
612	0	64	103	Echo Bells	2
613	0	65	103	Big Pan	2
614	0	66	103	Synth Piano	2
615	0	67	103	Creation	2
616	0	68	103	Star Dust	2
617	0	69	103	Reso&Panning	2
618	0	0	104	Sci-Fi	2
619	0	64	104	Starz	2
620	0	0	105	Sitar	1
621	0	32	105	DetunedSitar	2
622	0	35	105	Sitar 2	2
623	0	96	105	Tambra	2
624	0	97	105	Tamboura	2
625	0	0	106	Banjo	1
626	0	28	106	Muted Banjo	1
627	0	96	106	Rabab	2
628	0	97	106	Gopichant	2
629	0	98	106	Oud	2
630	0	0	107	Shamisen	1
631	0	0	108	Koto	1
632	0	96	108	Taisho-kin	2
633	0	97	108	Kanoon	2
634	0	0	109	Kalimba	1
635	0	0	110	Bagpipe	2
636	0	0	111	Fiddle	1
637	0	0	112	Shanai	1
638	0	64	112	Shanai2	1
639	0	96	112	Pungi	1
640	0	97	112	Hichiriki	2
641	0	0	113	Tinkle Bell	2
642	0	96	113	Bonang	2
643	0	97	113	Altair	2
644	0	98	113	GamelanGongs	2
645	0	99	113	StereoGamlan	2
646	0	100	113	Rama Cymbal	2
647	0	101	113	Asian Bells	2
648	0	0	114	Agogo	1
649	0	0	115	Steel Drums	1
650	0	97	115	Glass Perc.	2
651	0	98	115	Thai Bells	2
652	0	0	116	Woodblock	1
653	0	96	116	Castanets	1
654	0	0	117	Taiko Drum	1
655	0	96	117	Gran Cassa	1
656	0	0	118	Melodic Tom	1
657	0	64	118	MelodicTom2	1
658	0	65	118	Real Tom	2
659	0	66	118	Rock Tom	2
660	0	0	119	Synth Drum	1
661	0	64	119	Analog Tom	1
662	0	65	119	ElectroPerc.	2
663	0	0	120	Rev.Cymbal	1
664	0	0	121	GtrFretNoise	1
665	0	0	122	Breath Noise	1
666	0	0	123	Seashore	2
667	0	0	124	Bird Tweet	2

Voice Number	Bank Select		MIDI Program Change Number	Voice Name	Number of Notes Used
	MSB	LSB			
668	0	0	125	TelephonRing	1
669	0	0	126	Helicopter	1
670	0	0	127	Applause	1
671	0	0	128	Gunshot	1
672	64	0	1	CuttingNoise	1
673	64	0	2	CuttingNoiz2	2
674	64	0	4	String Slap	1
675	64	0	17	Fl.Key Click	1
676	64	0	33	Shower	1
677	64	0	34	Thunder	1
678	64	0	35	Wind	1
679	64	0	36	Stream	2
680	64	0	37	Bubble	2
681	64	0	38	Feed	2
682	64	0	49	Dog	1
683	64	0	50	Horse	1
684	64	0	51	Bird Tweet 2	1
685	64	0	55	Ghost	2
686	64	0	56	Maou	2
687	64	0	65	Phone Call	1
688	64	0	66	Door Squeak	1
689	64	0	67	Door Slam	1
690	64	0	68	Scratch Cut	1
691	64	0	69	ScratchSplit	1
692	64	0	70	Wind Chime	1
693	64	0	71	TelphonRing2	1
694	64	0	81	CarEngineIgn	1
695	64	0	82	CarTiresSql	1
696	64	0	83	Car Passing	1
697	64	0	84	Car Crash	1
698	64	0	85	Siren	2
699	64	0	86	Train	1
700	64	0	87	Jet Plane	2
701	64	0	88	Starship	2
702	64	0	89	Burst	2
703	64	0	90	RollrCoaster	2
704	64	0	91	Submarine	1
705	64	0	97	Laugh	1
706	64	0	98	Scream	1
707	64	0	99	Punch	1
708	64	0	100	Heartbeat	1
709	64	0	101	FootSteps	1
710	64	0	113	Machine Gun	1
711	64	0	114	Laser Gun	2
712	64	0	115	Explosion	2
713	64	0	116	Firework	2

Drum Kit List

- “<—” indicates that the drum kit is the same as “Standard Kit1”.
- Each percussion voice uses one note, whereas one marked () = uses two notes.
- The note numbers and note names printed on the keyboard are one octave higher than the MIDI note numbers and note names shown in the list. For example, the note number and note name, #36 and C1, on the keyboard correspond to the MIDI note number and note name, #24 and C0, shown in the list.

Bank MSB		127	127	127	127	127	127	127
Bank LSB		0	0	0	0	0	0	0
Prgram Number		1	2	9	17	25	26	28
Note #	Note	Standard Kit 1	Standard Kit 2	Room Kit	Rock Kit	Electro Kit	Analog Kit	Dance Kit
	13	C#-1	Surdo Mute	<—	<—	<—	<—	<—
	14	D-1	Surdo Open	<—	<—	<—	<—	<—
	15	D#-1	Hi Q	<—	<—	<—	<—	<—
	16	E-1	Whip Slap	<—	<—	<—	<—	<—
	17	F-1	Scratch H	<—	<—	<—	<—	<—
	18	F#-1	Scratch L	<—	<—	<—	<—	<—
	19	G-1	Finger Snap	<—	<—	<—	<—	<—
	20	G#-1	Click Noise	<—	<—	<—	<—	<—
	21	A-1	Metronome Click	<—	<—	<—	<—	<—
	22	A#-1	Metronome Bell	<—	<—	<—	<—	<—
	23	B-1	Seq Click L	<—	<—	<—	<—	<—
	24	C0	Seq Click H	<—	<—	<—	<—	<—
C1	25	C#0	Brush Tap	<—	<—	<—	<—	<—
D1	26	D0	Brush Swirl	<—	<—	<—	<—	<—
E1	27	D#0	Brush Slap	<—	<—	<—	<—	<—
F1	28	E0	Brush Tap Swirl	<—	<—	Reverse Cymbal	Reverse Cymbal	Reverse Cymbal
G1	29	F0	Snare Roll	<—	<—	<—	<—	<—
A1	30	F#0	Castanet	<—	<—	Hi Q 2	Hi Q 2	Hi Q 2
B1	31	G0	Snare Soft	Snare Soft 2	<—	Snare Noisy	Snare Snappy Electro	Snare Noisy 4
C2	32	G#0	Sticks	<—	<—	<—	<—	<—
D2	33	A0	Kick Soft	<—	<—	Kick 3	Kick 3	Kick Techno Q
E2	34	A#0	Open Rim Shot	Open Rim Shot H Short	<—	<—	<—	Rim Gate
F2	35	B0	Kick Tight	<—	<—	Kick 2	Kick Gate	Kick Techno L
G2	36	C1	Kick	Kick Short	<—	Kick Gate	Kick Gate Heavy	Kick Techno 2
A2	37	C#1	Side Stick	Side Stick Light	<—	<—	<—	Side Stick Analog
B2	38	D1	Snare	Snare Short	Snare Snappy	Snare Rock	Snare Noisy 2	Snare Analog
C3	39	D#1	Hand Clap	<—	<—	<—	<—	Snare Clap
D3	40	E1	Snare Tight	Snare Tight H	Snare Tight Snappy	Snare Rock Tight	Snare Noisy 3	Snare Analog 2
E3	41	F1	Floor Tom L	<—	Tom Room 1	Tom Rock 1	Tom Electro 1	Tom Analog 1
F3	42	F#1	Hi-Hat Closed	<—	<—	<—	<—	Hi-Hat Closed Analog
G3	43	G1	Floor Tom H	<—	Tom Room 2	Tom Rock 2	Tom Electro 2	Tom Analog 2
A3	44	G#1	Hi-Hat Pedal	<—	<—	<—	<—	Hi-Hat Closed Analog 2
B3	45	A1	Low Tom	<—	Tom Room 3	Tom Rock 3	Tom Electro 3	Tom Analog 3
C4	46	A#1	Hi-Hat Open	<—	<—	<—	<—	Hi-Hat Open Analog
D4	47	B1	Mid Tom L	<—	Tom Room 4	Tom Rock 4	Tom Electro 4	Tom Analog 4
E4	48	C2	Mid Tom H	<—	Tom Room 5	Tom Rock 5	Tom Electro 5	Tom Analog 5
F4	49	C#2	Crash Cymbal 1	<—	<—	<—	<—	Crash Analog
G4	50	D2	High Tom	<—	Tom Room 6	Tom Rock 6	Tom Electro 6	Tom Analog 6
A4	51	D#2	Ride Cymbal 1	<—	<—	<—	<—	<—
B4	52	E2	Chinese Cymbal	<—	<—	<—	<—	<—
C5	53	F2	Ride Cymbal Cup	<—	<—	<—	<—	<—
D5	54	F#2	Tambourine	<—	<—	<—	<—	<—
E5	55	G2	Splash Cymbal	<—	<—	<—	<—	<—
F5	56	G#2	Cowbell	<—	<—	<—	<—	Cowbell Analog
G5	57	A2	Crash Cymbal 2	<—	<—	<—	<—	Cowbell Analog
A5	58	A#2	Vibraslap	<—	<—	<—	<—	<—
B5	59	B2	Ride Cymbal 2	<—	<—	<—	<—	<—
C6	60	C3	Bongo H	<—	<—	<—	<—	<—
D6	61	C#3	Bongo L	<—	<—	<—	<—	<—
E6	62	D3	Conga H Mute	<—	<—	<—	<—	Conga Analog H
F6	63	D#3	Conga H Open	<—	<—	<—	<—	Conga Analog M
G6	64	E3	Conga L	<—	<—	<—	<—	Conga Analog L
A6	65	F3	Timbale H	<—	<—	<—	<—	<—
B6	66	F#3	Timbale L	<—	<—	<—	<—	<—
C7	67	G3	Agogo H	<—	<—	<—	<—	<—
D7	68	G#3	Agogo L	<—	<—	<—	<—	<—
E7	69	A3	Cabasa	<—	<—	<—	<—	<—
F7	70	A#3	Maracas	<—	<—	<—	<—	Maracas 2
G7	71	B3	Samba Whistle H	<—	<—	<—	<—	Maracas 2
A7	72	C4	Samba Whistle L	<—	<—	<—	<—	<—
B7	73	C#4	Guiro Short	<—	<—	<—	<—	<—
C8	74	D4	Guiro Long	<—	<—	<—	<—	<—
D8	75	D#4	Claves	<—	<—	<—	<—	Claves 2
E8	76	E4	Wood Block H	<—	<—	<—	<—	Claves 2
F8	77	F4	Wood Block L	<—	<—	<—	<—	<—
G8	78	F#4	Cuica Mute	<—	<—	<—	Scratch H 2	Scratch H 2
A8	79	G4	Cuica Open	<—	<—	<—	Scratch L 2	Scratch L 2
B8	80	G#4	Triangle Mute	<—	<—	<—	<—	Scratch L 2
C9	81	A4	Triangle Open	<—	<—	<—	<—	<—
D9	82	A#4	Shaker	<—	<—	<—	<—	<—
E9	83	B4	Jingle Bells	<—	<—	<—	<—	<—
F9	84	C5	Bell Tree	<—	<—	<—	<—	<—
G9	85	C#5						
A9	86	D5						
B9	87	D#5						
C0	88	E5						
D0	89	F5						
E0	90	F#5						
F0	91	G5						

Bank MSB		127	127	127	127	126	126	126
Bank LSB		0	0	0	0	0	0	0
Prgram Number		33	41	49	81	36	1	2
Note #	Note	Jazz Kit	Brush Kit	Symphony Kit	Style Kit	Arabic Kit	SFX Kit 1	SFX Kit 2
	13	C#-1	<<<	<<<	<<<	<<<		
	14	D-1	<<<	<<<	<<<	<<<		
	15	D#-1	<<<	<<<	<<<	<<<		
	16	E-1	<<<	<<<	<<<	<<<		
	17	F-1	<<<	<<<	<<<	<<<		
	18	F#-1	<<<	<<<	<<<	<<<		
	19	G-1	<<<	<<<	<<<	<<<		
	20	G#-1	<<<	<<<	<<<	<<<		
	21	A-1	<<<	<<<	<<<	<<<		
	22	A#-1	<<<	<<<	<<<	<<<		
	23	B-1	<<<	<<<	<<<	<<<		
	24	C0	<<<	<<<	<<<	<<<		
C1								
C#1	25	C#0	<<<	<<<	<<<	Nakarazan Dom		
D1	26	D0	<<<	<<<	<<<	Cabasa		
D#1	27	D#0	<<<	<<<	<<<	Nakarazan Edge		
E1	28	E0	<<<	<<<	<<<	Hager Dom		
F1	29	F0	<<<	<<<	<<<	Hager Edge		
F#1	30	F#0	<<<	<<<	<<<	Bongo H		
G1	31	G0	Snare Jazz H	Brush Slap 2	<<<	Bongo L		
G#1	32	G#0	<<<	<<<	<<<	Conga H Mute		
A1	33	A0	<<<	<<<	Kick Soft 2	Conga H Open		
A#1	34	A#0	<<<	Open Rim Shot Light	<<<	Conga L		
B1	35	B0	<<<	<<<	Open Rim Shot Style	Zagrouda H		
C2	36	C1	Kick Jazz	Kick Jazz	Gran Cassa	Zagrouda L		
C#2	37	C#1	Side Stick Light	Side Stick Light	Gran Cassa Mute	Kick Style	Cutting Noise	Phone Call
D2	38	D1	Snare Jazz L	Brush Slap 3	<<<	Side Stick Style	Cutting Noise 2	Door Squeak
D#2	39	D#1	<<<	<<<	Band Snare	Side Stick		Door Slam
E2	40	E1	Snare Jazz M	Brush Tap 2	Band Snare 2	Snare Style	Snare Soft	Door Slam
F2	41	F1	<<<	Tom Brush 1	<<<	Arabic Hand Clap	String Slap	Scratch Cut
F#2	42	F#1	<<<	<<<	<<<	Snare		Scratch H 3
G2	43	G1	<<<	Tom Brush 2	<<<	Floor Tom L Style		Wind Chime
G#2	44	G#1	<<<	<<<	<<<	Hi-Hat Closed Style		Telephone Ring 2
A2	45	A1	<<<	Tom Brush 3	<<<	Floor Tom H Style		
A#2	46	A#1	<<<	<<<	<<<	Hi-Hat Pedal Style		
B2	47	B1	<<<	Tom Brush 4	<<<	Low Tom Style		
C3	48	C2	<<<	Tom Brush 5	<<<	Hi-Hat Open Style		
C#3	49	C#2	<<<	<<<	Hand Cymbal	Mid Tom L Style		
D3	50	D2	<<<	Tom Brush 6	<<<	Mid Tom H Style		
D#3	51	D#2	<<<	<<<	Hand Cymbal Short	Mid Tom H		
E3	52	E2	<<<	<<<	<<<	Crash Cymbal 1 Style		
F3	53	F2	<<<	<<<	<<<	Ride Cymbal 1 Style	Flute Key Click	Car Engine Ignition
F#3	54	F#2	<<<	<<<	<<<	Chinese Cymbal Style		Car Tires Squeal
G3	55	G2	<<<	<<<	<<<	Ride Cymbal Cup Style	Duhulla Dom	Car Passing
G#3	56	G#2	<<<	<<<	<<<	Splash Cymbal Style	Duhulla Tak	Car Crash
A3	57	A2	<<<	<<<	Hand Cymbal 2	Crash Cymbal 2 Style	Duhulla Sak	Siren
A#3	58	A#2	<<<	<<<	<<<	Crash Cymbal 2 Style	Duhulla Sak	Train
B3	59	B2	<<<	<<<	Hand Cymbal 2 Short	Ride Cymbal 2 Style	Claves	Jet Plane
C4	60	C3	<<<	<<<	<<<	Doff Dom		Starship
C#4	61	C#3	<<<	<<<	<<<	Katem Dom		Burst
D4	62	D3	<<<	<<<	<<<	Katem Tak		Roller Coaster
D#4	63	D#3	<<<	<<<	<<<	Katem Sak		Submarine
E4	64	E3	<<<	<<<	<<<	Katem Tak		
F4	65	F3	<<<	<<<	<<<	Doff Tak		
F#4	66	F#3	<<<	<<<	<<<	Tabla Dom		
G4	67	G3	<<<	<<<	<<<	Tabla Tak1		
G#4	68	G#3	<<<	<<<	<<<	Tabla Tik		
A4	69	A3	<<<	<<<	<<<	Tabla Tak2	Shower	Laugh
A#4	70	A#3	<<<	<<<	<<<	Tabla Sak	Thunder	Scream
B4	71	B3	<<<	<<<	<<<	Tabla Roll of Edge	Wind	Punch
C5	72	C4	<<<	<<<	<<<	Tabla Flam	Stream	Heart Beat
C#5	73	C#4	<<<	<<<	<<<	Sagat 1	Bubble	Foot Steps
D5	74	D4	<<<	<<<	<<<	Tabel Dom	Feed	
D#5	75	D#4	<<<	<<<	<<<	Sagat 3		
E5	76	E4	<<<	<<<	<<<	Tabel Tak		
F5	77	F4	<<<	<<<	<<<	Sagat 2		
F#5	78	F#4	<<<	<<<	<<<	Rik Dom		
G5	79	G4	<<<	<<<	<<<	Rik Tak 2		
G#5	80	G#4	<<<	<<<	<<<	Rik Finger 1		
A5	81	A4	<<<	<<<	<<<	Rik Tak 1		
A#5	82	A#4	<<<	<<<	<<<	Rik Finger 2		
B5	83	B4	<<<	<<<	<<<	Rik Brass Tremolo		
C6	84	C5	<<<	<<<	<<<	Rik Sak		
	85	C#5	<<<	<<<	<<<	Rik Tik	Dog	Machine Gun
	86	D5	<<<	<<<	<<<		Horse	Laser Gun
	87	D#5	<<<	<<<	<<<		Bird Tweet 2	Explosion
	88	E5	<<<	<<<	<<<			Firework
	89	F5	<<<	<<<	<<<			
	90	F#5	<<<	<<<	<<<		Ghost	
	91	G5	<<<	<<<	<<<		Maou	

Style List

Style Number	Style Name
8 Beat	
1	8 Beat 1
2	8 Beat 2
3	8 Beat 3
4	8 Beat Adria
5	8 Beat Party
6	8 Beat Rock
7	Root Rock
8	Hard Rock
16 Beat	
9	16 Beat Pop
10	Guitar Pop
11	Kool Shuffle
12	Pop Shuffle
13	Jazz Rock
Ballad	
14	16 Beat Ballad
15	Slow & Easy
16	Love Song
17	Organ Ballad
18	Analog Ballad
19	6/8 Slow Rock
20	Modern 6/8
21	Acoustic Ballad
Dance	
22	House
23	Eurobeat
24	Euro House
25	Trance
26	Clubdance
27	Techno
28	Hip Hop
29	Trip Hop
30	Groundbeat
Disco	
31	Saturday Night
32	70's Disco
33	Disco Chocolate
34	Disco Hands
35	Disco Funk
36	Disco Fox
37	Disco Party
Swing & Jazz	
38	Big Band 1
39	Big Band 2
40	Big Band 3
41	Swing
42	Swingfox
43	Shuffle
44	Acoustic Jazz
45	Jazz Ballad
46	Dixieland
R & B	
47	Soul Shuffle
48	Cat Groove
49	Gospel Brothers
50	Gospel Sisters
51	Boogie Woogie
52	Croco Twist
53	Rock & Roll
54	60's Rock & Roll
55	Soul
56	Rock Shuffle
57	Motown Soul
58	6/8 Blues

Style Number	Style Name
Country	
59	Country Rock
60	Country 2/4
61	Country 8 Beat
62	Country Pop
63	Country Swing
64	Country Shuffle
65	Country Ballad
66	Country Waltz
67	Bluegrass
68	Hoedown
Latin	
69	Latin Pop
70	Samba City
71	Bossa Nova
72	Guitar Bossa
73	Mambo
74	Salsa
75	Beguine
76	Gypsy Rumba
77	Pop Rumba
78	Happy Reggae
79	Disco Latin
March & Waltz	
80	US March
81	German March
82	6/8 March
83	Polka Oberkrainer
84	Waltz Oberkrainer
85	Polka Pop
86	Tarantella
87	Reel
88	Musette
89	Jazz Waltz
90	Christmas 3/4
91	Slow Waltz
Ballroom	
92	Vienna Waltz
93	English Waltz
94	Slowfox
95	Quickstep
96	Foxtrot
97	Tango
98	Samba
99	Rumba
100	Cha Cha Cha
101	Pasodoble
102	Jive
Pianist	
103	P_Swing
104	P_Stride
105	P_Boogie
106	P_Ballad
107	P_Pianoman
108	P_March
109	P_6/8 March
110	P_Ragtime
111	P_Jazz Waltz
112	P_Waltz

Music Database List

MDB Number	Song Name
POP HITS	
1	Alive Fever
2	Alive Synth
3	Croco Rock
4	D.Survival
5	EasySunday1
6	EasySunday2
7	GoingMyWay 1
8	GoingMyWay 2
9	Hurry Luv
10	I'm Torn
11	Imagination
12	Just Called
13	Just the way
14	Love is Deep
15	Music Thanks
16	Nikita Trp.
17	Paradise Day
18	Proud Guitar
19	Sailing Sax
20	SeptemberPop
21	Sultan Swing
22	Sweet Lord
23	TitanicHeart
24	WatchGirls1
25	WatchGirls2
26	WaterlooShfl
27	Whiter Shade
28	YesterGuitar
SWING & JAZZ	
29	Days of Sax
30	Honey Taste
31	Lost Heart
32	MistyGeorgia
33	Moon Jazz
34	Moonlight 1
35	Moonlight 2
36	New York 1
37	New York 2
38	New York 3
39	PantherSwing
40	Patrol Brass
41	Patrol Sax
42	PetiteClari.
43	Ragtime Band
44	RedRoseSwing
45	Saints March
46	Satin Woodw.
47	Sax The Mood
48	Shear Jazz
49	Show Bizz
50	Splanky Trb.
51	Sunny Side
52	Two Foot 5
53	WaltzingBlue
54	What is new?
55	WildCatDixie
56	Wonderland
EVERGREEN	
57	Black Forest
58	California
59	Ciao Capri
60	Close on You
61	D'Amour Str.
62	Do you wish?
63	Dolanes Song
64	El Condor
65	Entertainer
66	EpicSymphony
67	In the Night
68	In the Rain
69	Love Stories
70	Lucky Sax
71	MillionStars
72	My Prince
73	O Sole Mio
74	PalomaGuitar

MDB Number	Song Name
75	Puppet Brass
76	Raindrops
77	Red Moulin
78	Romantic Gtr
79	SchiwagoMood
80	Shadow Gtr.
81	Small Planet
82	Snow White
83	Spanish Eyes
84	Tie a Ribbon
85	Time goes by
86	Wonder World
ROMANTIC BALLADS	
87	Adeline B.
88	ArgentinaCry
89	BlueAcordion
90	Body Beauty
91	Cat Memory
92	CavatinaSolo
93	Deep Ballad
94	Elvis Ballad
95	Fly Away
96	GoodFeelings
97	GreenSleeves
98	Gtr.Concerto
99	Guitar Date
100	Hard to Say1
101	Hard to Say2
102	Lonely Piper
103	Moon Tenor
104	MusicboxDnce
105	NorwegianFlt
106	RainbowAbove
107	Red Lady
108	Release me
109	SavingMyLove
110	SierraMusett
111	Silent Sound
112	Silvery Moon
113	Smokey Eyes
114	StrangeShore
115	Sweet Orch
116	Unplugged
117	Whisper Sax
ROCK & FUSION	
118	Dave again
119	Funky Pieces
120	Jump Rock
121	Oye Como Cha
122	RiverRedRock
123	SatisfiedGtr
124	Sheriff Shot
125	Smokey Water
126	Twist again
127	Venus Pop
RHYTHM & BLUES	
128	Amazing
129	Baby Baby
130	BoogieManiac
131	Clock Rock
132	Gator Boogie
133	Happy Day!
134	Johnny Good
135	Melon Cat
136	Mercy Bros.
137	Rising Sun
138	Supergroove1
139	Supergroove2
HIP HOP HOUSE	
140	Boy Group
141	Funky City
142	Funky Disco
143	Grounded
144	Miami Trance
145	Nine PM
146	Only TwoOfUs
147	Rap Talk

MDB Number	Song Name
148	Soft Kill
149	Techno Dolls
LATIN NIGHTS	
150	Bamba Brass
151	Bamba Flute
152	Be Happy!
153	Day & Night
154	Ipanema 1
155	Ipanema 2
156	Latin Lola
157	MarinaMusett
158	Mucho Tromb.
159	Smooth Latin
160	Sun of Life
161	Sunshine
162	Tico Organ
163	TromboneWave
COUNTRY & WESTERN	
164	AlabamaBanjo
165	Blowing Wind
166	Bonanza
167	Green Grass
168	JambalayaFlt
169	LondonStreet
170	Lucille Str.
171	Think Twice
172	Top World
173	WestVirginia
BALLROOM & PARTY	
174	Aloha Hawaii
175	BabylonDisco
176	Barbados!
177	Brazil Brass
178	Charming 3/4
179	Cherry Brass
180	Cherry Organ
181	ChickenSynth
182	Cumparsita
183	Danube Waves
184	FiestaMexico
185	HandsUpParty
186	Modern Talk
187	Next Alice
188	Paloma Flute
189	Pub Piano
190	Sandman Fox
191	Sunday Never
192	Tea Time Cha
193	ThemeOfLove
194	Tijuana 1
195	Tijuana 2
196	Tulip'sWaltz
197	Why MCA?
198	"YesSir,Quick"
TRADITIONAL	
199	Alpen Trio
200	Balalaikas
201	Ceilidh Band
202	Ciel deParis
203	Clarinet Fun
204	Comrades
205	Happy Polka
206	Herzilein
207	Jingle Bells
208	KufsteinSong
209	La Danza
210	MexiHatDance
211	Mickey Flute
212	Navy Anchors
213	Rolla Barrel
214	Snow Waltz
215	Star March 1
216	Star March 2
217	The Hornpipe
218	Washington
219	Wood Cutters
220	Xmas Night

About the Digital Effects (Reverb/Chorus/DSP)

● Reverb (System effect)

Reverb effect type/depth can be set by panel operation.

When you select a different style, the appropriate reverb type will be selected accordingly.

● Chorus (System effect)

Chorus effect type/depth can be set by panel operation.

When you select a different style, the appropriate chorus type will be selected accordingly.

● DSP (System/Insertion effect)

DSP effect on/off status, type and depth can be set by panel operation.

DSP effect will function as either System or Insertion effect. Whether DSP effect is System or Insertion depends on the selected type. DSP effect configuration will differ between System and Insertion effects as follows:

NOTE

- Although not all the effect settings cannot be made by operating the PSR-550 panel manually, some of them may be accessible through MIDI. Refer to the MIDI data format for details.

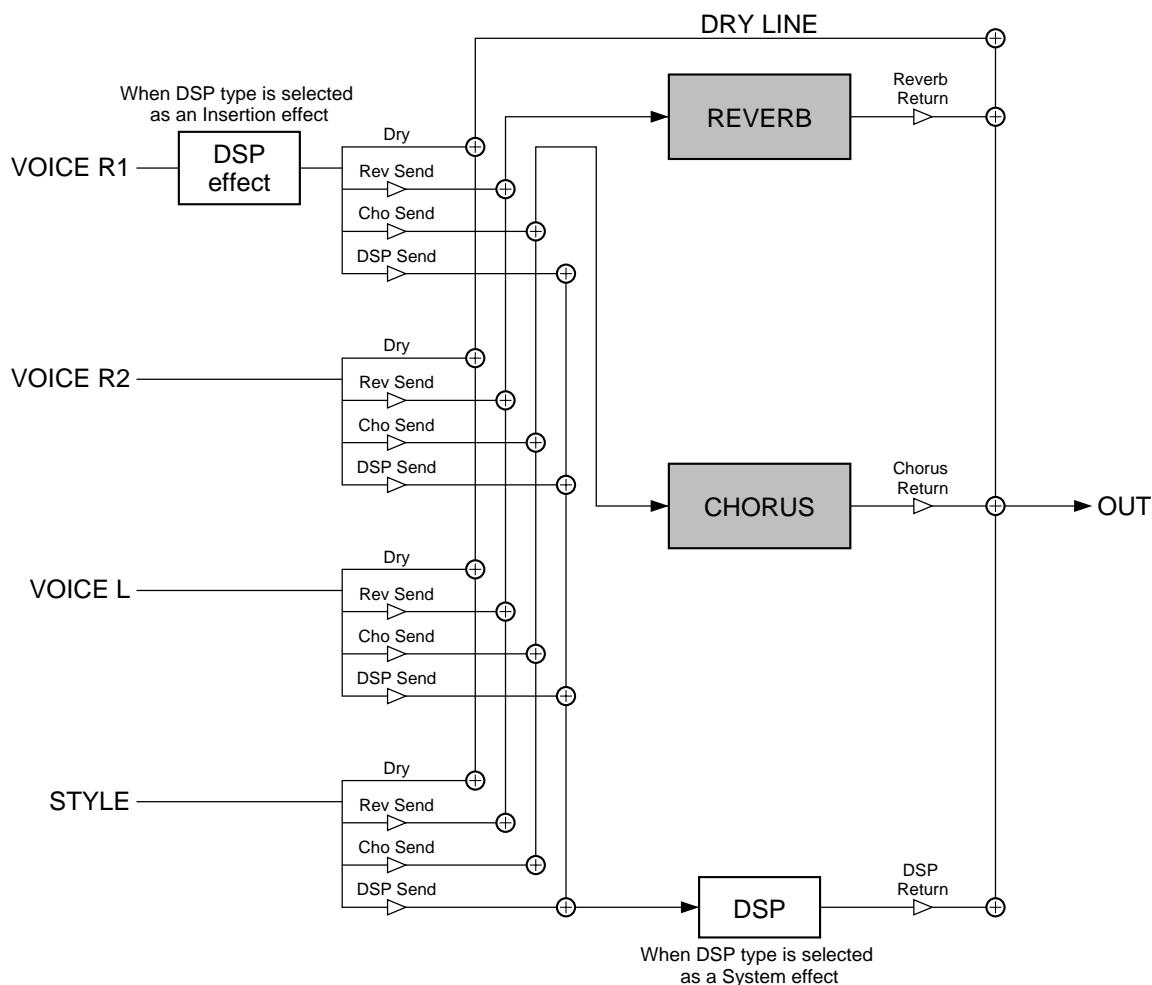

● Reverb Type List

Reverb Type	System/Insertion	Description
Hall1-5	System	Concert hall reverb.
Room1-7	System	Small room reverb.
Stage1-4	System	Reverb for solo instruments.
Plate1-3	System	Simulated steel plate reverb.
White Room	System	A unique short reverb with a bit of initial delay.
Tunnel	System	Simulation of a tunnel space expanding to left and right.
Canyon	System	A hypothetical acoustic space which extends without limit.
Basement	System	A bit of initial delay followed by reverb with a unique resonance.
No Effect	—	No effect.













● Chorus Type List

Chorus Type	System/Insertion	Description
Chorus1-8	System	Conventional chorus program with rich, warm chorusing.
Celeste1, 2	System	A 3-phase LFO adds modulation and spaciousness to the sound.
Flanger1-5	System	Pronounced three-phase modulation with slight metallic sound.
No Effect	—	No effect.

● DSP Type List

DSPTYPE	System/Insertion	Description
Hall1-5	System	Concert hall reverb.
Room1-7	System	Small room reverb.
Stage1-4	System	Reverb for solo instruments.
Plate1-3	System	Simulated steel plate reverb.
Delay Left - Center - Right1, 2	System	Three independent delays, for the left, right and center stereo positions.
Delay Left - Right	System	Initial delay for each stereo channel, and two separate feedback delays.
Echo	System	Stereo delay, with independent feedback level settings for each channel.
Cross Delay	System	Complex effect that sends the delayed repeats "bouncing" between the left and right channels.
ER1, 2	System	This effect isolates only the early reflection components of the reverb.
Gate Reverb	System	Gated reverb effect, in which the reverberation is quickly cut off for special effects.
Reverse Gate	System	Similar to Gate Reverb, but with a reverse increase in reverb.
Karaoke1-3	System	A delay with feedback of the same types as used for karaoke reverb.
Chorus1-8	System	Conventional chorus program with rich, warm chorusing.
Celeste1, 2	System	A 3-phase LFO adds modulation and spaciousness to the sound.
Flanger1-5	System	Pronounced three-phase modulation with slight metallic sound.
Symphonic1, 2	System	A multi-phase version of Celeste.
Rotary Speaker 1-6	Insertion	Rotary speaker simulation.
Tremolo1-3	Insertion	Rich Tremolo effect with both volume and pitch modulation.
Guitar Tremolo	Insertion	Simulated electric guitar tremolo.
Auto Pan1, 2	Insertion	Several panning effects that automatically shift the sound position (left, right, front, back).
Phaser 1, 2	System	Pronounced, metallic modulation with periodic phase change.
Distortion Hard	Insertion	Hard-edge distortion.
Distortion Soft	Insertion	Soft, warm distortion.
Distortion Heavy	Insertion	Heavy distortion.
Overdrive	Insertion	Adds mild distortion to the sound.
Amp Simulator	Insertion	A simulation of a guitar amp.
EQ Disco	Insertion	Equalizer effect that boosts both high and low frequencies, as is typical in most disco music.
EQ Telephone	Insertion	Equalizer effect that cuts both high and low frequencies, to simulate the sound heard through a telephone receiver.
3Band EQ (MONO)	Insertion	A mono EQ with adjustable LOW, MID, and HIGH equalizing.
2Band EQ (STEREO)	Insertion	A stereo EQ with adjustable LOW and HIGH. Ideal for drum Parts.
Auto Wah1, 2	Insertion	Cyclically modulates the center frequency of a wah filter.
No Effect	—	No effect.
Through	—	Bypass without applying an effect.

Harmony/Echo Type List

Category	Type	Description
Harmony	Duet	An extra note is added to the note played on the keyboard to produce duet type harmony.
	1+5	A parallel voice is produced a fifth above the note played on the keyboard.
	Country	One note is added above the note played on the keyboard for a country-style harmony feel.
	Trio	Two notes are added below the note played on the keyboard for three-part harmony.
	Block	Three or four notes are added to the note played on the keyboard to produce four or five-note chords.
	4Way Close1	Three harmony notes are generated to produce a four-note chord.
	4Way Close2	Similar to the preceding type, but depending on the chords played this type will sometimes produce a more colorful sound.
	4Way Open	Four-note chords with open voice (large intervals between the notes). The result is a very "open" sound. Since the harmony notes can be as much as two octaves below the note played on the keyboard, avoid playing in the lower registers.
	Octave	One note is added an octave below the note played on the keyboard.
	Strum	The notes and assignments are the same as in the Block type, but the notes are arpeggiated.
Echo	Echo 1/4 	An echo effect is applied to the note played on the keyboard at the currently set tempo.
	Echo 1/6 	
	Echo 1/8 	
	Echo 1/12 	
Tremolo	Tremolo 1/8 	A tremolo effect is applied to the note played on the keyboard at the currently set tempo.
	Tremolo 1/12 	
	Tremolo 1/16 	
	Tremolo 1/32 	
Trill	Trill 1/12 	Two notes played on the keyboard are played alternately at the currently set tempo.
	Trill 1/16 	
	Trill 1/24 	
	Trill 1/32 	

Troubleshooting

PROBLEM	POSSIBLE CAUSE/SOLUTION
<ul style="list-style-type: none"> The speakers produce a “pop” sound whenever the power is turned ON or OFF. 	This is normal and is no cause for alarm.
<ul style="list-style-type: none"> When using a mobile phone, noise is produced. 	Using a mobile phone in close proximity to the PortaTone may produce interference. To prevent this, turn off the mobile phone or use it further away from the PortaTone.
<ul style="list-style-type: none"> The volume is reduced or the sound is distorted. The sound quality has gotten progressively worse. The registration memory doesn’t work properly. Recorded song data will not play back properly. The display goes blank and all panel controls are reset. 	The batteries probably need to be replaced. Either replace all six batteries, or use an AC power adaptor.
<ul style="list-style-type: none"> No sound results when the keyboard is played. 	<ul style="list-style-type: none"> The R1/R2/L voice volume (Mixer) settings could be set too low. Make sure the voice volumes are set at appropriate levels (page 76). The Local Control function could be turned off. Make sure Local Control is turned on (page 116). Check whether the naming function of Registration Memory or song recording (page 21) is called up in the display or not. If the naming function is active, the PSR-550 does not produce any sound, even when the keys are played.
<ul style="list-style-type: none"> Not all simultaneously-played notes sound. Auto Accompaniment seems to “skip” when the keyboard is played. 	You are probably exceeding the maximum polyphony of the PSR-550. The PSR-550 can play up to 32 notes at the same time — including voice R2, voice L, auto accompaniment, song, and multi pad notes. Notes exceeding this limit will not sound.
<ul style="list-style-type: none"> Nothing happens or nothing seems to function, even when pressing a panel button. For example, pressing the DEMO button does not start the Demo song, or playing the keyboard does not produce any sound. 	Make sure that Disk mode is engaged. In the Disk mode, no panel operations can be executed (except for disk operations), and playing the keyboard does not produce any sound. Exit from the display by pressing the [EXIT] button.
<ul style="list-style-type: none"> The accompaniment or song does not play back even when pressing the [START/STOP] button. The Multi Pads do not play back, even when one of the MULTI PAD buttons is pressed. 	The MIDI Clock may be set to “Ext”. Make sure it is set to “Int” (page 116).
<ul style="list-style-type: none"> The auto accompaniment does not start, even when the Synchro Start is in the standby condition and a key is pressed. 	You may be trying to start accompaniment by playing a key in the right-hand range of the keyboard. To start the accompaniment with Synchro Start, make sure to play a key in the left-hand (accompaniment) range of the keyboard.
<ul style="list-style-type: none"> The following buttons related to the auto accompaniment do not function. <ul style="list-style-type: none"> [SYNC START] button [SYNC STOP] button [ACMP ON/OFF] button REGISTRATION MEMORY [FREEZE] button 	Check whether the Song mode (page 25) is selected or not. When the Song mode is active, none of the auto accompaniment functions can be used.
<ul style="list-style-type: none"> Certain notes sound at the wrong pitch. 	Make sure that the scale tuning value for those notes is set to “0.” If not, select the template “Equal” to recall the normal tuning of ± 0 cents (page 119).
<ul style="list-style-type: none"> Auto accompaniment chords are recognized regardless of the split point or where chords are played on the keyboard. 	Check whether the fingering mode is set to “Full” or not. If the Full fingering mode is selected, chords are recognized over the entire range of the keyboard, irrespective of the split point setting.
<ul style="list-style-type: none"> The Harmony function does not operate. 	<ul style="list-style-type: none"> Harmony cannot be turned on when the Full Keyboard fingering mode is selected or if a percussion kit voice is selected. Select an appropriate fingering mode or voice. Harmony cannot be turned on when a drum kit is selected for the voice R1.
<ul style="list-style-type: none"> MIDI data is not transmitted or received, even when MIDI cables are connected properly. 	The MIDI terminals can only be used when the HOST SELECT switch is set to “MIDI.” All other settings (“Mac,” “PC-1,” and “PC-2”) are for direct transmission/reception with a computer.

Data Backup & Initialization

■ Data Backup

Except for the data listed below, all PSR-550 panel settings are reset to their initial settings whenever the power is turned on. The data listed below are backed up - i.e. retained in memory - as long as an AC adaptor is connected or a set of batteries is installed.

- User Style data page 96
- User Pad data page 92
- Registration Memory data page 54
- Registration Memory Bank Number page 56
- Registration Memory/One Touch Setting status page 55
- Freeze on/off page 55
- MIDI Transmit settings page 114
- MIDI Receive settings page 115
- Voice Set on/off page 120
- Voice L (Voice Change, Mixer) page 74
- Fingering mode page 38
- Split Point page 120
- Sustain on/off page 30
- Upper Octave setting page 119
- Pitch Bend Range page 122
- Scale Tuning page 119
- Transpose page 30
- Footswitch Function, Polarity page 121
- Touch on/off, Sensitivity page 120
- Multi Pad setting page 43
- Master Tuning page 119
- Metronome on/off page 118

Even though these settings are retained in memory, you should save them — and all your important data — to floppy disk for permanent, safe storage. To save all of the data types listed above to floppy disk, use the Save operation (page 60) and select “All” as the file type.

All data listed above will be lost if the power is interrupted — in other words, if the power is turned off, the AC adaptor is disconnected and the batteries are removed. When this happens, the next time you turn on the PSR-550, a “Clear Backup” message appears in the display, the Data Initialization operation (below) is automatically executed, and the PSR-550 is set to the Style mode (page 25).

■ Data Initialization

All data can be initialized and restored to the factory preset condition by turning on the power while holding the highest (rightmost) white key on the keyboard. “Now Initializing” will appear briefly on the display.

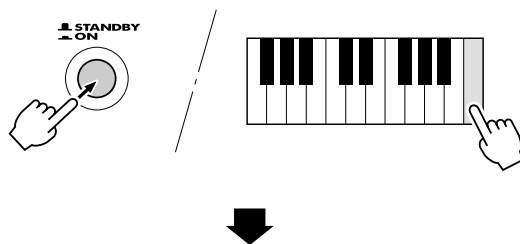

Now Initializing

⚠ CAUTION

- All registration and User Style/Pad memory data, plus the other settings listed above, will be erased and/or changed when the data initialization procedure is carried out.
- Carrying out the data initialization procedure will usually restore normal operation if the PSR-550 freezes or begins to act erratically for any reason.

Alert Message List

No File

The disk contains no file to be loaded, copied, or be deleted.
Insert the disk that contains files to be loaded, copied, or deleted.

Unformatted Disk

An unformatted disk is inserted.

Disk Error

An error occurred during execution of a disk operation.
Try changing the disk.
This message also may appear when executing the Load operation if the internal memory becomes full.

Write-Protected

The floppy disk's write-protect tab is set to ON.
Remove the disk, set write-protect to off, reinsert the disk and attempt the operation again.

File Protected

The file is a purposely "copy-protected" disk.
The Copy function is not possible.

No Disk

There is no floppy disk inserted into the disk drive.
Insert a disk.

Insert Song Disk

This message appears when you press the [SONG] button without a disk in the disk drive.

Disk Removed

An error occurred because the disk was removed during a disk operation.
Never remove a disk during a disk operation since this could damage both the disk and the drive.

Disk Full

The disk's memory capacity is full and no additional data can be recorded.
Delete one or more unneeded songs (using Delete), and attempt the operation again.

Wrong Disk

When using the Copy operation, the inserted disk is different from the source or destination disk.
Remove the disk and reinsert the proper Disk.

Same Name

More than one file has the same name on the disk.
Change the name.

Maximum 60 Songs

Maximum of 60 songs can be recorded.
Delete one or more unneeded songs (using Delete), and attempt the song recording again.

Memory Full

If the internal memory becomes full during Style/Pad recording, this message will appear on the display and recording will stop.

Alert Message List

Memory Over

This message appears when executing the Quantize or Recording operations (in the Style Recording mode) when the internal memory is full.

Data Not Found

This message appears when you attempt to edit, quantize or clear the track which contains no data in the Record mode.

User Style Full

This message indicates that recording a new User style cannot be started when all three User styles have recorded data. Make sure to clear at least one of the three User styles before recording a new User style.

Preset Data

This message appears when you attempt to edit, or quantize the track (other than RHYTHM) which contains preset data in the Style Record mode.

Cannot Operate

This function cannot be used during Song/Style/Pad recording.

Cannot Set MIDI

The MIDI function cannot be set during recording, playback, and disk operations.

Cannot Turn Har. On

Harmony cannot be turned on during Style/Pad recording.

Cannot Turn DSP On

DSP cannot be turned on during Style/Pad recording.

Cannot Enter Func.

This message appears to indicate you cannot enter the function when you select a Multi Pad function in the Multi Pad Recording mode.

Clear Backup

- This message may appear when the PSR-550 is turned on, and indicates that user data temporarily stored in the internal memory has been lost (page 136). When this happens, the Data Initialization operation (page 136) is automatically executed, and the PSR-550 is set to the Style mode (page 25).
- If this message appears even when the AC adaptor is connected or the battery power is adequate, the backup data (page 136) is faulty. Use the Data Initialization function (page 136).

Now Initializing

All data can be initialized and restore to the factory preset condition by turning the STANDBY switch ON while holding the highest (rightmost) white key on the keyboard.

Battery Low

When the batteries run down this message appears every few seconds. Exchange all the batteries with the new ones according to the instructions on page 12.

MIDI Data Format

Many MIDI messages listed in the MIDI Data Format are expressed in decimal numbers, binary numbers and hexadecimal numbers. Hexadecimal numbers may include the letter "H" as a suffix. Also, "n" can freely be defined as any whole number. To enter data/values, refer to the table below.

Decimal	Hexadecimal	Binary	Decimal	Hexadecimal	Binary
0	00	0000 0000	64	40	0100 0000
1	01	0000 0001	65	41	0100 0001
2	02	0000 0010	66	42	0100 0010
3	03	0000 0011	67	43	0100 0011
4	04	0000 0100	68	44	0100 0100
5	05	0000 0101	69	45	0100 0101
6	06	0000 0110	70	46	0100 0110
7	07	0000 0111	71	47	0100 0111
8	08	0000 1000	72	48	0100 1000
9	09	0000 1001	73	49	0100 1001
10	0A	0000 1010	74	4A	0100 1010
11	0B	0000 1011	75	4B	0100 1011
12	0C	0000 1100	76	4C	0100 1100
13	0D	0000 1101	77	4D	0100 1101
14	0E	0000 1110	78	4E	0100 1110
15	0F	0000 1111	79	4F	0100 1111
16	10	0001 0000	80	50	0101 0000
17	11	0001 0001	81	51	0101 0001
18	12	0001 0010	82	52	0101 0010
19	13	0001 0011	83	53	0101 0011
20	14	0001 0100	84	54	0101 0100
21	15	0001 0101	85	55	0101 0101
22	16	0001 0110	86	56	0101 0110
23	17	0001 0111	87	57	0101 0111
24	18	0001 1000	88	58	0101 1000
25	19	0001 1001	89	59	0101 1001
26	1A	0001 1010	90	5A	0101 1010
27	1B	0001 1011	91	5B	0101 1011
28	1C	0001 1100	92	5C	0101 1100
29	1D	0001 1101	93	5D	0101 1101
30	1E	0001 1110	94	5E	0101 1110
31	1F	0001 1111	95	5F	0101 1111
32	20	0010 0000	96	60	0110 0000
33	21	0010 0001	97	61	0110 0001
34	22	0010 0010	98	62	0110 0010
35	23	0010 0011	99	63	0110 0011
36	24	0010 0100	100	64	0110 0100
37	25	0010 0101	101	65	0110 0101
38	26	0010 0110	102	66	0110 0110
39	27	0010 0111	103	67	0110 0111
40	28	0010 1000	104	68	0110 1000
41	29	0010 1001	105	69	0110 1001
42	2A	0010 1010	106	6A	0110 1010
43	2B	0010 1011	107	6B	0110 1011
44	2C	0010 1100	108	6C	0110 1100
45	2D	0010 1101	109	6D	0110 1101
46	2E	0010 1110	110	6E	0110 1110
47	2F	0010 1111	111	6F	0110 1111
48	30	0011 0000	112	70	0111 0000
49	31	0011 0001	113	71	0111 0001
50	32	0011 0010	114	72	0111 0010
51	33	0011 0011	115	73	0111 0011
52	34	0011 0100	116	74	0111 0100
53	35	0011 0101	117	75	0111 0101
54	36	0011 0110	118	76	0111 0110
55	37	0011 0111	119	77	0111 0111
56	38	0011 1000	120	78	0111 1000
57	39	0011 1001	121	79	0111 1001
58	3A	0011 1010	122	7A	0111 1010
59	3B	0011 1011	123	7B	0111 1011
60	3C	0011 1100	124	7C	0111 1100
61	3D	0011 1101	125	7D	0111 1101
62	3E	0011 1110	126	7E	0111 1110
63	3F	0011 1111	127	7F	0111 1111

- Except the table above, for example 144-159(decimal)/9nH/1001 0000-1001 1111(binary) displays the Note On Message for each channel (1-16).
176-191/BnH/1011 0000-1011 1111 displays the Control Change Message for each channel (1-16).
192-207/CnH/1100 0000-1100 1111 displays the Program Change Message for each channel (1-16).
240/FOH/1111 0000 denotes the start of a System Exclusive Message.
247/F7H/1111 0111 denotes the end of a System Exclusive Message.
- aaH (hexadecimal)/0aaaaaaa (binary) denotes the data address. The address contains High, Mid, and Low.
- bbH/0bbbbbbb denotes the byte count.
- ccH/0ccccccc denotes the check sum.
- ddH/0ddddddd denotes the data/value.

(1) TRANSMIT FLOW

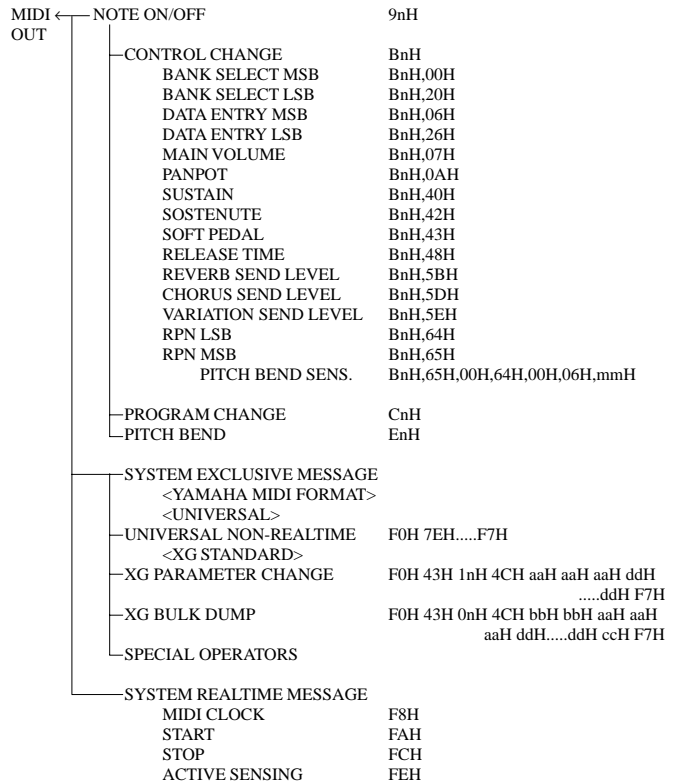

(2) RECEIVE FLOW

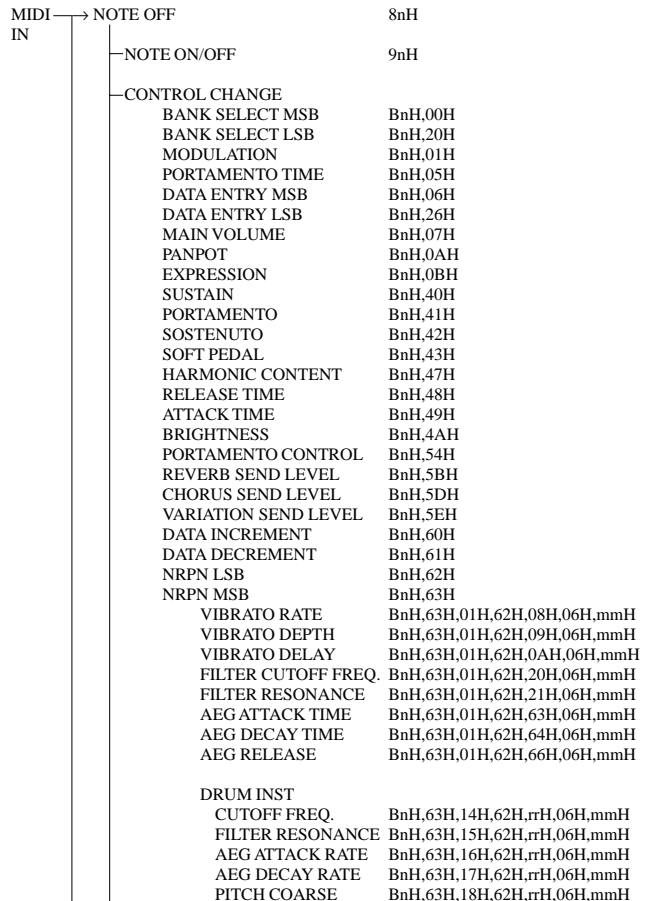

PITCH FINE	BnH,63H,19H,62H,rrH,06H,mmH
LEVEL	BnH,63H,1AH,62H,rrH,06H,mmH
PANPOT	BnH,63H,1CH,62H,rrH,06H,mmH
REVERB SEND	BnH,63H,1DH,62H,rrH,06H,mmH
CHORUS SEND	BnH,63H,1EH,62H,rrH,06H,mmH
VARIATION SEND	BnH,63H,1FH,62H,rrH,06H,mmH
RPN LSB	BnH,64H
RPN MSB	BnH,65H
PITCH BEND SENS.	BnH,65H,00H,64H,00H,06H,mmH
FINE TUNING	BnH,65H,00H,64H,01H,06H,mmH, 26H,IIH
COARSE TUNING	BnH,65H,00H,64H,02H,06H,mmH
NULL	BnH,65H,7FH,64H,7FH
ALL SOUND OFF	BnH,78H,00H
RESET ALL CONTROLLERS	BnH,79H,00H
ALL NOTES OFF	BnH,7BH,00H
OMNI OFF	BnH,7CH,00H
OMNI ON	BnH,7DH,00H
MONO	BnH,7EH
POLY	BnH,7FH
PROGRAM CHANGE	CnH
CHANNEL AFTER TOUCH	DnH
PITCH BEND CHANGE	EnH
SYSTEM EXCLUSIVE MESSAGE	
<YAMAHA MIDI FORMAT>	
<UNIVERSAL>	
UNIVERSAL REALTIME	F0H 7FH.....F7H
UNIVERSAL NON-REALTIME	F0H 7EH.....F7H
<XG STANDARD>	
XG PARAMETER CHANGE	F0H 43H 1nH 4CH aaH aaH ddHddH F7H
XG BULK DUMP	F0H 43H 0nH 4CH bbH bbH aaH aaH aaH ddH.....ddH ccH F7H
PARAMETER REQUEST	F0H 43H 3nH 4CH aaH aaH aaH F7H
DUMP REQUEST	F0H 43H 2nH 4CH aaH aaH aaH F7H
SPECIAL OPERATORS	
Others	
SYSTEM REALTIME MESSAGE	
MIDI CLOCK	F8H
START	FAH
STOP	FCH
ACTIVE SENSING	FEH

(3) TRANSMIT/RECEIVE DATA

(3-1) CHANNEL VOICE MESSAGES

(3-1-1) NOTE OFF (Receive only)

STATUS	1000nnn(8nH)	n = 0 - 15 VOICE CHANNEL NUMBER
NOTE NUMBER	0kkkkkkk	k = 0 (C-2) - 127 (G8)
VELOCITY	0vvvvvvv	v: ignored

(3-1-2) NOTE ON/OFF

STATUS	1001nnnn(9nH)	n = 0 - 15 VOICE CHANNEL NUMBER
NOTE NUMBER	0kkkkkkk	k = 0 (C-2) - 127 (G8)
VELOCITY	0vvvvvvv	(v≠0) NOTE ON
	00000000	(v=0) NOTE OFF

(3-1-3) PROGRAM CHANGE

STATUS	1100nnnn(CnH)	n = 0 - 15 VOICE CHANNEL NUMBER
PROGRAM NUMBER	0ppppppp	p = 0 - 127

*** PROGRAM NUMBER: XG DRUM VOICE number correspondence**

P = 0	Standard Kit
P = 1	Standard2 Kit
P = 8	Room Kit
P = 16	Rock Kit
P = 24	Elctrnk Kit
P = 25	Analog Kit
P = 27	Dance Kit
P = 32	Jazz Kit
P = 40	Brush Kit
P = 48	Symphonic Kit

*** PROGRAM NUMBER: XG SFX KIT number correspondence**

P = 0	SFX1 Kit
P = 1	SFX2 Kit

When DRUM VOICE is selected and program change data for a different DRUM VOICE is received, the currently selected DRUM VOICE will be replaced with the new DRUM VOICE.

(3-1-4) CHANNEL AFTER TOUCH (Receive only)

STATUS	1101nnnn(DnH)	n = 0 - 15 VOICE CHANNEL NUMBER
VALUE	0vvvvvvv	v = 0 - 127 AFTER TOUCH VALUE

(3-1-5) PITCH BEND CHANGE

STATUS	1110nnnn(EnH)	n = 0 - 15 VOICE CHANNEL NUMBER
LSB	0vvvvvvv	PITCH BEND CHANGE LSB
MSB	0vvvvvvv	PITCH BEND CHANGE MSB

(3-1-6) CONTROL CHANGE

STATUS	1011nnnn(BnH)	n = 0 - 15 VOICE CHANNEL NUMBER
CONTROL NUMBER	0ccccccc	
CONTROL VALUE	0vvvvvvv	

*** Transmit CONTROL NUMBER.**

c = 0	BANK SELECT MSB	; v = 0: XG NORMAL, 64: SFX NORMAL, 126: XG SFX KIT, 127: XG DRUM
c = 32	BANK SELECT LSB	; v = 0 - 127
c = 6	DATA ENTRY MSB	; v = 0 - 127
c = 38	DATA ENTRY LSB	; v = 0 - 127
c = 7	MAIN VOLUME	; v = 0 - 127
c = 10	PANPOT	; v = 0 - 127
c = 64	SUSTAIN	; v = 0-63: OFF, 64-127: ON
c = 66	SOSTENUTO	; v = 0-63: OFF, 64-127: ON
c = 67	SOFT PEDAL	; v = 0-63: OFF, 64-127: ON
c = 72	RELEASE TIME	; v = 0:-64-64:0-127:+63
c = 91	REVERB SEND LEVEL	; v = 0 - 127
c = 93	CHORUS SEND LEVEL	; v = 0 - 127
c = 94	VARIATION SEND LEVEL	; v = 0 - 127
		(When only Connection = 1[System])
c = 100	RPN LSB	Refer to "(3-3)REGISTERED PARAMETER NUMBER"
c = 101	RPN MSB	Refer to "(3-3)REGISTERED PARAMETER NUMBER"

*** Receive CONTROL NUMBER.**

c = 0	BANK SELECT MSB	; v = 0: XG NORMAL, 64: SFX NORMAL, 126: XG SFX KIT, 127: XG DRUM
c = 32	BANK SELECT LSB	; v = 0 - 127
c = 1	MODULATION	; v = 0 - 127
c = 5	PORTAMENTO TIME	; v = 0 - 127
c = 6	DATA ENTRY MSB	; v = 0 - 127
c = 38	DATA ENTRY LSB	; v = 0 - 127
c = 7	MAIN VOLUME	; v = 0 - 127
c = 10	PANPOT	; v = 0 - 127
c = 11	EXPRESSION	; v = 0 - 127
c = 64	SUSTAIN	; v = 0-63: OFF, 64-127: ON
c = 65	PORTAMENTO	; v = 0-63: OFF, 64-127: ON
c = 66	SOSTENUTO	; v = 0-63: OFF, 64-127: ON
c = 67	SOFT PEDAL	; v = 0-63: OFF, 64-127: ON
c = 71	HARMONIC CONTENT	; v = 0:-64 - 64:0 - 127:+63
c = 72	RELEASE TIME	; v = 0:-64 - 64:0 - 127:+63
c = 73	ATTACK TIME	; v = 0:-64 - 64:0 - 127:+63
c = 74	BRIGHTNESS	; v = 0:-64 - 64:0 - 127:+63
c = 84	PORTAMENTO CONTROL	; v = 0 - 127
c = 91	REVERB SEND LEVEL	; v = 0 - 127
c = 93	CHORUS SEND LEVEL	; v = 0 - 127
c = 94	VARIATION SEND LEVEL	; v = 0 - 127
		(When only Connection=1[System])
c = 96	DATA INCREMENT	; v = 0 - 127
c = 97	DATA DECREMENT	; v = 0 - 127
c = 98	NRPN LSB	Refer to "(3-4)NON-REGISTERED PARAMETER NUMBER"
c = 99	NRPN MSB	Refer to "(3-4)NON-REGISTERED PARAMETER NUMBER"
c = 100	RPN LSB	Refer to "(3-3)REGISTERED PARAMETER NUMBER"
c = 101	RPN MSB	Refer to "(3-3)REGISTERED PARAMETER NUMBER"

*1 Only when setting the appointed parameter with RPN.
*2 Does not effect Rhythm Voice.

• Until a PROGRAM CHANGE message is received, the BANK SELECT operation will be suspended.

When a Voice, including VOICE BANK, is changed, set the BANK SELECT and Program Change Message, and transmit in the following order, BANK SELECT MSB, LSB, PROGRAM CHANGE.

• MODULATION controls the Vibrato Depth.

• PORTAMENTO TIME controls the Pitch Change Speed when the Portamento Switch is ON. 0 being the shortest time, and 127 being the longest.

• PANPOT changes the value for the melody voice and rhythm voice in relation to the preset value.

• Portamento time is fixed to 0 when the PORTAMENTO CONTROL is used.

• HARMONIC CONTENT applies adjustment to the resonance value that is set by the voice.

This parameter specifies relative change with the value of 64 producing 0 adjustment. As values get higher the sound becomes increasingly eccentric.

Note that for some voices the effective parameter range is narrower than the legal parameter range.

- **RELEASE TIME** applies adjustment to the envelope release time set by the voice. This parameter specifies relative change with the value of 64 producing 0 adjustment.
- **ATTACK TIME** applies adjustment to the envelope attack time set by the voice. This parameter specifies relative change with the value of 64 producing 0 adjustment.
- **BRIGHTNESS** applies adjustment to the cut-off frequency set by the voice. This parameter specifies relative change with the value of 64 producing 0 adjustment. Lower voices produce a softer sound. For some voices the effective parameter range is narrower than the legal parameter range.

(3-2) CHANNEL MODE MESSAGES

STATUS 1011nnnn(BnH) n = 0 - 15 VOICE CHANNEL NUMBER
 CONTROL NUMBER 0ccccccc c = CONTROL NUMBER
 CONTROL VALUE 0vvvvvvv v = DATA VALUE

(3-2-1) ALL SOUND OFF (Receive only)

(CONTROL NUMBER = 78H, DATA VALUE = 0)

Switches off all sound from the channel.
 Does not reset Note On and Hold On conditions established by Channel Messages.

(3-2-2) RESET ALL CONTROLLERS (Receive only)

(CONTROL NUMBER = 79H, DATA VALUE = 0)

Resets controllers as follows.

PITCH BEND CHANGE	0 (Center)
AFTER TOUCH	0 (min.)
MODULATION	0 (min.)
EXPRESSION	127 (max.)
SUSTAIN	0 (off)
SOSTENUTO	0 (off)
SOFT PEDAL	0 (off)
NRPN	Sets number to null. (Internal data remains unchanged)
RPN	Sets number to null. (Internal data remains unchanged)
PORTAMENTO CONTROL	Resets portamento source note number
PORTAMENTO	0 (off)

(3-2-3) ALL NOTES OFF (Receive only)

(CONTROL NUMBER = 7BH, DATA VALUE = 0)

Switches off all of the channel's "on" notes.
 However, any notes being held by SUSTAIN or SOSTENUTO continue to sound until SUSTAIN/SOSTENUTO goes off.

(3-2-4) OMNI OFF (Receive only)

(CONTROL NUMBER = 7CH, DATA VALUE = 0)

Same processing as for All Notes Off.

(3-2-5) OMNI ON (Receive only)

(CONTROL NUMBER = 7DH, DATA VALUE = 0)

Same processing as for All Notes Off. Omni On is not executed.

(3-2-6) MONO (Receive only) (CONTROL NUMBER = 7EH, DATA VALUE = 0)

Same processing as for All Notes Off.
 If the 3rd byte is in a range of 0-16 the corresponding channel will be changed to Mode 4 (m=1).

(3-2-7) POLY (Receive only) (CONTROL NUMBER = 7FH, DATA VALUE = 0)

Same processing as for All Sounds Off and the corresponding channel will be changed to Mode 3.

(3-3) REGISTERED PARAMETER NUMBER (RPN)

STATUS 1011nnnn(BnH) n = 0 - 15 VOICE CHANNEL NUMBER
 RPN LSB 01100100(64H)
 RPN LSB NUMBER 0ppppppp p = RPN LSB(refer to the list below)
 RPN MSB 01100101(65H)
 RPN MSB 0qqqqqqq q = RPN MSB(refer to the list below)
 DATA ENTRY MSB 00000110(06H)
 DATA VALUE 0mmmmmmm m = Data Value
 DATA ENTRY LSB 00100110(26H)
 DATA VALUE 0lllllll l = Data Value

First appoints the parameter for RPN MSB/LSB, then sets the parameter value for data entry MSB/LSB.

RPN	D.ENTRY	MSB	LSB	MSB	LSB	PARAMETER NAME	DATA RANGE
00H	00H	mmH	—			PITCH BEND SENSITIVITY	00H - 18H(0 - 24 semitones)
01H	00H	mmH	llH			FINE TUNE	{mmH, llH} = {00H, 00H} - {40H, 00H} - {7FH, 7FH} (-8192*100/8192) - 0 - (+8192*100/8192)
02H	00H	mmH	—			COARSE TUNE	28H - 40H - 58H (-24 - 0 - +24 semitones)
7FH	7FH	—	—			NULL	Clears the current RPN number setting. Does not change the internal parameter settings.

(3-4) NON-REGISTERED PARAMETER NUMBER (NRPN) (Receive only)

STATUS 1011nnnn(BnH) n = 0 - 15 VOICE CHANNEL NUMBER

NRPN LSB 01100010(62H)
 NRPN LSB NUMBER 0ppppppp p = NRPN LSB(refer to the list below)
 NRPN MSB 01100011(63H)
 NRPN MSB NUMBER 0qqqqqqq q = NRPN MSB(refer to the list below)
 DATA ENTRY MSB 00000110(06H)
 DATA VALUE 0mmmmmmm m = Data Value

First appoints the parameter for NRPN MSB/LSB, then sets the parameter value for data entry MSB/LSB.

NRPN	D.ENTRY	MSB	LSB	MSB	LSB	PARAMETER NAME	DATA RANGE
01H	08H	mmH	—			VIBRATO RATE	00H - 40H - 7FH (-64 - 0 - +63)
01H	09H	mmH	—			VIBRATO DEPTH	00H - 40H - 7FH (-64 - 0 - +63)
01H	0AH	mmH	—			VIBRATO DELAY	00H - 40H - 7FH (-64 - 0 - +63)
01H	20H	mmH	—			FILTER CUTOFF FREQUENCY	00H - 40H - 7FH (-64 - 0 - +63)
01H	21H	mmH	—			FILTER RESONANCE	00H - 40H - 7FH (-64 - 0 - +63)
01H	63H	mmH	—			EG ATTACK TIME	00H - 40H - 7FH (-64 - 0 - +63)
01H	64H	mmH	—			EG DECAY TIME	00H - 40H - 7FH (-64 - 0 - +63)
01H	66H	mmH	—			EG RELEASE	00H - 40H - 7FH (-64 - 0 - +63)
14H	rrH	mmH	—			DRUM FILTER CUTOFF FREQ.	00H - 40H - 7FH (-64 - 0 - +63)
15H	rrH	mmH	—			DRUM FILTER RESONANCE	00H - 40H - 7FH (-64 - 0 - +63)
16H	rrH	mmH	—			DRUM AEG ATTACK RATE	00H - 40H - 7FH (-64 - 0 - +63)
17H	rrH	mmH	—			DRUM AEG DECAY RATE	00H - 40H - 7FH (-64 - 0 - +63)
18H	rrH	mmH	—			DRUM PITCH COARSE	00H - 40H - 7FH (-64 - 0 - +63)
19H	rrH	mmH	—			DRUM PITCH FINE	00H - 40H - 7FH (-64 - 0 - +63)
1AH	rrH	mmH	—			DRUM LEVEL	00H - 7FH (0 - max.)
1CH	rrH	mmH	—			DRUM PANPOT	00H, 01H - 40H - 7FH (random, left - center - right)
1DH	rrH	mmH	—			DRUM REVERB SEND LEVEL	00H - 7FH (0 - max.)
1EH	rrH	mmH	—			DRUM CHORUS SEND LEVEL	00H - 7FH (0 - max.)
1FH	rrH	mmH	—			DRUM VARIATION SEND LEVEL	00H - 7FH (0 - max.)

The MSG14H-1FH (for drums) message is accepted as long as the channel is set with a drum voice.

rrH : drum instrument note number

(3-5) SYSTEM REALTIME MESSAGES

(3-5-1) MIDI CLOCK

STATUS 11111000 (F8H)

Transmission: 96 clocks per measure are transmitted.

Reception: If the instrument's clock is set to external, after FAH is received from the external device the instrument's clock will sync with the 96 beats per measure received from the external device.

Decides whether the internal clock, or Timing Clocks received via the MIDI IN will be used.

(3-5-2) START

STATUS 11111010 (FAH)

Transmission: Transmitted when instrument's Rhythm or Song playback is started.

Reception: Depending upon the condition, Rhythm, Song Playback, or Song Rec will start.

(3-5-3) STOP

STATUS 11111100 (FCH)

Transmission: Transmitted when instrument's Rhythm or Song playback is stopped.

Reception: Depending upon the condition, Rhythm, Song Playback, or Song Rec will stop.

(3-5-4) ACTIVE SENSING

STATUS 11111110 (FEH)

Transmission: Transmitted approximately once every 200msec.

Reception: Depending upon the condition, Rhythm, Song Playback, or Song Rec will stop.

(3-6) SYSTEM EXCLUSIVE MESSAGE

(3-6-1) YAMAHA MIDI FORMAT

(3-6-1-1) SECTION CONTROL

binary	hexadecimal	
11110000	F0	Exclusive status
01000011	43	YAMAHA ID
01111110	7E	Style
00000000	00	
0sssssss	SS	Switch No.
		00H : INTRO A
		01H - 07H : INTRO B
		08H : MAIN A
		09H - 0FH : MAIN B
		10H : FILL IN A
		11H - 1FH : FILL IN B
		20H : ENDING A
		21H - 27H : ENDING B
0ddddddd	DD	Switch On/Off: 00H(Off), 7FH(On)
11110111	F7	End of Exclusive

When an ON code is received, the appointed section will be changed.

(3-6-1-2) TEMPO CONTROL

binary	hexadecimal	
11110000	F0	Exclusive status
01000011	43	YAMAHA ID
01111110	7E	Style
00000000	01	
0ttttttt	TT	Tempo4
0ttttttt	TT	Tempo3
0ttttttt	TT	Tempo2
0ttttttt	TT	Tempo1
11110111	F7	End of Exclusive

The internal clock will be set to the received Tempo value.
Tempo Meta Event is a large data block (24-bit), it is divided into 4 groups with 7-bits going into each of the Tempos 1-4 (4 receives the remaining 3 bits).

(3-6-2) UNIVERSAL SYSTEM EXCLUSIVE

(3-6-2-1) UNIVERSAL REALTIME MESSAGE

(3-6-2-1-1) MIDI MASTER VOLUME (Receive only)

binary	hexadecimal	
11110000	F0	Exclusive status
01111111	7F	Universal Realtime
01111111	7F	ID of target Device
00001000	04	Sub-ID #1=Device Control Message
00000001	01	Sub-ID #2=Master Volume
0sssssss	SS	Volume LSB
0ttttttt	TT	Volume MSB
11110111	F7	End of Exclusive
or		
11110000	F0	Exclusive status
01111111	7F	Universal Realtime
0xxxxxxx	XN	When N is received N=0-F, whichever is received. When N is transmitted N always=0. X = don't care
00001000	04	Sub-ID #1=Device Control Message
00000001	01	Sub-ID #2=Master Volume
0sssssss	SS	Volume LSB
0ttttttt	TT	Volume MSB
11110111	F7	End of Exclusive

The volume for all channels will be changed simultaneously.
The TT value is used as the MIDI Master Volume value. (the ss value is ignored.)

(3-6-2-2) UNIVERSAL NON REALTIME MESSAGE

(3-6-2-2-1) GENERAL MIDI SYSTEM ON

binary	hexadecimal	
11110000	F0	Exclusive status
01111110	7E	Universal Non-Realtime
01111111	7F	ID of target Device
00001001	09	Sub-ID #1=General MIDI Message
00000001	01	Sub-ID #2=General MIDI On
11110111	F7	End of Exclusive
or		
11110000	F0	Exclusive status
01111110	7E	Universal Non-Realtime
0xxxxxxx	XN	When N is received N=0-F, whichever is received. When N is transmitted N always=0. X = don't care
00001001	09	Sub-ID #1=General MIDI Message
00000001	01	Sub-ID #2=General MIDI On
11110111	F7	End of Exclusive

Depending upon the received ON message, the System Mode will be changed to XG. Except MIDI Master Tuning, all control data be reset to default values.
This message requires approximately 50ms to execute, so sufficient time should be allowed before the next message is sent.
The bank select message for the channel 10 and the NRPN message are not received in the GM mode.

(3-6-3) XG STANDARD

(3-6-3-1) XG PARAMETER CHANGE

(3-6-3-1-1) XG SYSTEM ON

binary	hexadecimal	
11110000	F0	Exclusive status
01000011	43	YAMAHA ID
0001nnnn	1N	Device Number
01001100	4C	Model ID
00000000	00	Address High
00000000	00	Address Mid
01111110	7E	Address Low
00000000	00	Data
11110111	F7	End of Exclusive

Depending upon the received ON message, the SYSTEM MODE will be changed to XG. Controllers will be reset, all values of Multi Part and Effect, and All System values denoted by "XG" data within All System will be reset to default values in the table. This message requires approximately 50ms to execute, so sufficient time should be allowed before the next message is sent.

(3-6-3-1-2) XG PARAMETER CHANGE

binary	hexadecimal	
11110000	F0	Exclusive status
01000011	43	YAMAHA ID
0001nnnn	1N	Device Number
01001100	4C	Model ID
0aaaaaaa	AA	Address High
0aaaaaaa	AA	Address Mid
0aaaaaaa	AA	Address Low
0ddddd	DD	Data
11110111	F7	End of Exclusive

For parameters with data size of 2 or 4, transmit the appropriate number of data bytes. For more information on Address and Parameters, refer to < Table 1-2 > - < Table 1-5 >.

The data types listed below are transmitted and received.

System Data
Multi Effect1 Data
Multi Part Data
Drums Setup Data

(3-6-3-2) XG BULK DUMP

binary	hexadecimal	
01110000	F0	Exclusive status
01000011	43	YAMAHA ID
0000nnnn	0N	Device Number
01001100	4C	Model ID
0bbbbbbb	BB	ByteCount MSB
0bbbbbbb	BB	ByteCount LSB
0aaaaaaa	AA	Address High
0aaaaaaa	AA	Address Mid
0aaaaaaa	AA	Address Low
0ddddd	DD	Data
0ccccc	CC	Check sum
11110111	F7	End of Exclusive

For more information on Address and Byte Count, refer to < Table 1-2 > - < Table 1-5 >.
The Check Sum value is set such that the sum of Byte Count, Address, Data, and Check Sum has value zero in its seven least significant bits.
If the top of the block is appointed to the Address the XG Bulk Dump, Bulk Request will be received.
The Block is a unit that consists of the data, arranged in the list, as the Total Size.

The data types listed below are transmitted and received. (These are transmitted only after a Bulk Dump request is received.)

System Data
System Information (Transmit ONLY)
Multi Effect1 Data
Multi Part Data
Drums Setup Data

(3-6-3-3) XG PARAMETER REQUEST (Receive only)

binary	hexadecimal	
11110000	F0	Exclusive status
01000011	43	YAMAHA ID
0011nnnn	3n	Device Number
01001100	4C	Model ID
0aaaaaaa	AA	Address High
0aaaaaaa	AA	Address Mid
0aaaaaaa	AA	Address Low
11110111	F7	End of Exclusive

For more information on Address and Byte Count refer to < Table 1-2 > - < Table 1-5 >.

The data types listed below are received.

System Data
Multi Effect1 Data
Multi Part Data
Drums Setup Data

(3-6-3-4) XG DUMP REQUEST (Receive only)

binary	hexadecimal	
11110000	F0	Exclusive status
01000011	43	YAMAHA ID
0010nnnn	2n	Device Number
01001100	4C	Model ID
00aaaaaaa	AA	Address High
00aaaaaaa	AA	Address Mid
00aaaaaaa	AA	Address Low
11110111	F7	End of Exclusive

For more information on Address and Byte Count refer to < Table 1-2 > - < Table 1-5 >.

The data types listed below are received.

System Data
System Information
Multi Effect1 Data
Multi Part Data
Drums Setup Data

(3-6-4) CLAVINOVA MIDI COMPLIANCE

(3-6-4-1) DOC MULTI TIMBRE ON / OFF (Receive only)

binary	hexadecimal	Exclusive status
11110000	F0	YAMAHA ID
01000011	43	Clavinova ID
01110011	73	Clavinova common ID
00000001	01	N: 3(DOC Multi Timbre Off),4(DOC Multi Timbre On)
0001000n	1N	End of Exclusive
11110111	F7	

(3-6-4-2) MIDI FA CANCEL(Receive only)

binary	hexadecimal	Exclusive status
11110000	F0	YAMAHA ID
01000011	43	Clavinova ID
01110011	73	Clavinova common ID
00000001	01	MIDI FA Cancel
01100001	61	
11110111	F7	End of Exclusive

If this message is received, even if FAH is received the accompaniment/song will not start.

(3-6-5) SPECIAL OPERATORS

(3-6-5-1) VOLUME ,EXPRESSION AND PAN REALTIME CONTROL OFF

binary	hexadecimal	Exclusive status
11110000	F0	YAMAHA ID
01000011	43	Clavinova ID
01110011	73	Clavinova common ID
00000001	01	Sub ID
00010001	11	N = MIDI Channel
0000nmmn	0N	

01000101	45	Volume and Expression Realtime Control Off
0vvvvvvv	VV	Value VV: Off=7FH, on=OOH
11110111	F7	End of Exclusive

When "On" is received, subsequent volume, expression, and PAN changes are only valid after the reception of the next key on. Normal operation resumes when "Off" is received.

(3-6-6) Others

(3-6-6-1) MIDI MASTER TUNING(Receive only)

binary	hexadecimal	Exclusive status
11110000	F0	YAMAHA ID
01000011	43	When N is received N=0-F, whichever is received.
0001nnnn	1N	When N is transmitted N always=0.
00100111	27	Model ID
00110000	30	Sub ID
00000000	00	
00000000	00	
0mmmmmmm	MM	Master Tune MSB
0lllllll	LL	Master Tune LSB
0ccccccc	CC	don't care
11110111	F7	End of Exclusive

Changes tuning of all channels. MM, LL values are used to define the MIDI Master Tuning value.

$$T = M - 128$$

T : Tuning value (-99cent - +99cent)

M : A single byte value (28-228) consists of bytes 0-3 of MM = MSB, bytes 0-3 of LL = LSB.

In this setting, GM System ON, XG System ON will not be reset.

< Table 1-1> Parmeter Basic Address

SYSTEM	Parameter Change Address			Description
	(H)	(M)	(L)	
	00	00	00	System
	00	00	7D	Drum Setup Reset
	00	00	7E	XG System On
	00	00	7F	All Parameter Reset
INFORMATION	01	00	00	System Information
EFFECT 1	02	01	00	Effect1(Reverb,Chorus,Variation)
MULTI PART	08	00	00	Multi Part 1
				:
	08	0F	00	Multi Part 16
DRUM	30	0D	00	Drum Setup 1 → Address
	31	0D	00	Drum Setup 2 → Parameter
				:
	3n	0D	0	note number 13
	3n	0E	0	note number 14
				:
	3n	5B	0	note number 91

< Table 1-2 > MIDI Parameter Change table (SYSTEM)

Address (H)	Size (H)	Data (H)	Parameter Name	Description	Default Value (H)
00 00 00	4	0000	Master Tune	-102.4..+102.3[cent]	00 04 00 00 (400)
01		..07FF		1st bit3-0 → bit15-12	
02				2nd bit3-0 → bit11-8	
03				3rd bit3-0 → bit7-4	
04	1	00..7F	Master Volume	0..127	7F
05	1		Not Used		
06	1	28..58	Transpose	-24..+24[semitones]	40
7D		0n	Drum Setup Reset	0n=Drum Setup Number	
7E		00	XG System On	00=XG Sytem on	
7F		00	All Parameter Reset	00=on (receive only)	

TOTAL SIZE 7

< Table 1-3 > MIDI Parameter table (System information)

Address (H)	Size (H)	Data (H)	Parameter Name	Description
01 00 00	E	20..7F	Model Name	32..127(ASCII)
:				
0D				
0E	1	00		
0F	1	00		

TOTAL SIZE 10

(Transmitted by Dump Request. Not received. Bulk Dump Only)

MIDI Data Format

< Table 1-4 > MIDI Parameter Change table (EFFECT)

Address (H)	Size (H)	Data (H)	Parameter Name	Description	Default Value (H)
02 01 00	2	00..7F	Reverb Type MSB	Refer to the Ef. Type List	01(=HALL1)
		00..7F	Reverb Type LSB	00 : basic type	00
02	1	00..7F	Reverb Parameter 1	Refer to the Ef. Parameter List	Depend on Reverb type
03	1	00..7F	Reverb Parameter 2	Refer to the Ef. Parameter List	Depend on Reverb type
04	1	00..7F	Reverb Parameter 3	Refer to the Ef. Parameter List	Depend on Reverb type
05	1	00..7F	Reverb Parameter 4	Refer to the Ef. Parameter List	Depend on Reverb type
06	1	00..7F	Reverb Parameter 5	Refer to the Ef. Parameter List	Depend on Reverb type
07	1	00..7F	Reverb Parameter 6	Refer to the Ef. Parameter List	Depend on Reverb type
08	1	00..7F	Reverb Parameter 7	Refer to the Ef. Parameter List	Depend on Reverb type
09	1	00..7F	Reverb Parameter 8	Refer to the Ef. Parameter List	Depend on Reverb type
0A	1	00..7F	Reverb Parameter 9	Refer to the Ef. Parameter List	Depend on Reverb type
0B	1	00..7F	Reverb Parameter 10	Refer to the Ef. Parameter List	Depend on Reverb type
0C	1	00..7F	Reverb Return	-∞..0..+6dB(0..64..127)	40
0D	1	01..7F	Reverb Pan	L63..C..R63(1..64..127)	40
TOTAL SIZE 0E					
02 01 10	1	00..7F	Reverb Parameter 11	Refer to the Ef. Parameter List	Depend on Reverb type
11	1	00..7F	Reverb Parameter 12	Refer to the Ef. Parameter List	Depend on Reverb type
12	1	00..7F	Reverb Parameter 13	Refer to the Ef. Parameter List	Depend on Reverb type
13	1	00..7F	Reverb Parameter 14	Refer to the Ef. Parameter List	Depend on Reverb type
14	1	00..7F	Reverb Parameter 15	Refer to the Ef. Parameter List	Depend on Reverb type
15	1	00..7F	Reverb Parameter 16	Refer to the Ef. Parameter List	Depend on Reverb type
TOTAL SIZE 6					
02 01 20	2	00..7F	Chorus Type MSB	Refer to the Ef. Type List	41(=Chorus1)
		00..7F	Chorus Type LSB	00 : basic type	00
22	1	00..7F	Chorus Parameter 1	Refer to the Ef. Parameter List	Depend on Chorus Type
23	1	00..7F	Chorus Parameter 2	Refer to the Ef. Parameter List	Depend on Chorus Type
24	1	00..7F	Chorus Parameter 3	Refer to the Ef. Parameter List	Depend on Chorus Type
25	1	00..7F	Chorus Parameter 4	Refer to the Ef. Parameter List	Depend on Chorus Type
26	1	00..7F	Chorus Parameter 5	Refer to the Ef. Parameter List	Depend on Chorus Type
27	1	00..7F	Chorus Parameter 6	Refer to the Ef. Parameter List	Depend on Chorus Type
28	1	00..7F	Chorus Parameter 7	Refer to the Ef. Parameter List	Depend on Chorus Type
29	1	00..7F	Chorus Parameter 8	Refer to the Ef. Parameter List	Depend on Chorus Type
2A	1	00..7F	Chorus Parameter 9	Refer to the Ef. Parameter List	Depend on Chorus Type
2B	1	00..7F	Chorus Parameter 10	Refer to the Ef. Parameter List	Depend on Chorus Type
2C	1	00..7F	Chorus Return	-∞..0..+6dB(0..64..127)	40
2D	1	01..7F	Chorus Pan	L63..C..R63(1..64..127)	40
2E	1	00..7F	Send Chorus To Reverb	-∞..0..+6dB(0..64..127)	00
TOTAL SIZE 0F					
02 01 30	1	00..7F	Chorus Parameter 11	Refer to the Ef. Parameter List	Depend on Chorus Type
31	1	00..7F	Chorus Parameter 12	Refer to the Ef. Parameter List	Depend on Chorus Type
32	1	00..7F	Chorus Parameter 13	Refer to the Ef. Parameter List	Depend on Chorus Type
33	1	00..7F	Chorus Parameter 14	Refer to the Ef. Parameter List	Depend on Chorus Type
34	1	00..7F	Chorus Parameter 15	Refer to the Ef. Parameter List	Depend on Chorus Type
35	1	00..7F	Chorus Parameter 16	Refer to the Ef. Parameter List	Depend on Chorus Type
TOTAL SIZE 6					
02 01 40	2	00..7F	Variation Type MSB	Refer to the Ef. Type List	05(=DELAY L,C,R)
		00..7F	Variation Type LSB	00 : basic type	00
42	2	00..7F	Vari. Param. 1 MSB	Refer to the Ef. Parameter List	Depend on Vari. Type
		00..7F	Vari. Param. 1 LSB	Refer to the Ef. Parameter List	Depend on Vari. Type
44	2	00..7F	Vari. Param. 2 MSB	Refer to the Ef. Parameter List	Depend on Vari. Type
		00..7F	Vari. Param. 2 LSB	Refer to the Ef. Parameter List	Depend on Vari. Type
46	2	00..7F	Vari. Param. 3 MSB	Refer to the Ef. Parameter List	Depend on Vari. Type
		00..7F	Vari. Param. 3 LSB	Refer to the Ef. Parameter List	Depend on Vari. Type
48	2	00..7F	Vari. Param. 4 MSB	Refer to the Ef. Parameter List	Depend on Vari. Type
		00..7F	Vari. Param. 4 LSB	Refer to the Ef. Parameter List	Depend on Vari. Type
4A	2	00..7F	Vari. Param. 5 MSB	Refer to the Ef. Parameter List	Depend on Vari. Type
		00..7F	Vari. Param. 5 LSB	Refer to the Ef. Parameter List	Depend on Vari. Type
4C	2	00..7F	Vari. Param. 6 MSB	Refer to the Ef. Parameter List	Depend on Vari. Type
		00..7F	Vari. Param. 6 LSB	Refer to the Ef. Parameter List	Depend on Vari. Type
4E	2	00..7F	Vari. Param. 7 MSB	Refer to the Ef. Parameter List	Depend on Vari. Type
		00..7F	Vari. Param. 7 LSB	Refer to the Ef. Parameter List	Depend on Vari. Type
50	2	00..7F	Vari. Param. 8 MSB	Refer to the Ef. Parameter List	Depend on Vari. Type
		00..7F	Vari. Param. 8 LSB	Refer to the Ef. Parameter List	Depend on Vari. Type
52	2	00..7F	Vari. Param. 9 MSB	Refer to the Ef. Parameter List	Depend on Vari. Type
		00..7F	Vari. Param. 9 LSB	Refer to the Ef. Parameter List	Depend on Vari. Type
54	2	00..7F	Vari. Param. 10 MSB	Refer to the Ef. Parameter List	Depend on Vari. Type
		00..7F	Vari. Param. 10 LSB	Refer to the Ef. Parameter List	Depend on Vari. Type
56	1	00..7F	Variation Return	-∞..0..+6dB(0..64..127)	40
57	1	01..7F	Variation Pan	L63..C..R63(1..64..127)	40
58	1	00..7F	Send Vari. To Reverb	-∞..0..+6dB(0..96..127)	00
59	1	00..7F	Send Vari. To Chorus	-∞..0..+6dB(0..96..127)	00
5A	1	00..01	Variation Connection	0:insertion,1:system	00
5B	1	00..7F	Variation Part	part1..16(0..15),off(16..63,65..127),AD1(64)	7F
5C	1	00..7F	MW Vari. Ctrl Depth	-63..+63	40
5D	1	00..7F	PB Vari. Ctrl Depth	-63..+63	40
5E	1	00..7F	CAT Vari. Ctrl Depth	-63..+63	40
5F	1		Not Used		
60	1		Not Used		
TOTAL SIZE 21					
02 01 70	1	00..7F	Variation Parameter 11	option Parameter	Depend on Variation Type
71	1	00..7F	Variation Parameter 12	option Parameter	Depend on Variation Type
72	1	00..7F	Variation Parameter 13	option Parameter	Depend on Variation Type
73	1	00..7F	Variation Parameter 14	option Parameter	Depend on Variation Type
74	1	00..7F	Variation Parameter 15	option Parameter	Depend on Variation Type
75	1	00..7F	Variation Parameter 16	option Parameter	Depend on Variation Type
TOTAL SIZE 6					

< Table 1-5 > MIDI Parameter Change table (MULTI PART)

Address (H)		Size (H)	Data (H)	Parameter Name	Description	Default Value (H)
08	nn 00	1	00..20	Element Reserve	0..32	0(Part10),2(Others)
	nn 01	1	00..7F	Bank Select MSB	0..127	7F(Part10),00(Others)
	nn 02	1	00..7F	Bank Select LSB	0..127	00
	nn 03	1	00..7F	Program Number	1..128	00
	nn 04	1	00..0F, 7F	Rev Channel	0..15;1..16,127;off	Part No.
	nn 05	1	00..01	Mono/Poly Mode	0:mono,1:poly	01
	nn 06	1	00..03	Same Note Number Key On Assign	0:single 1:multi 2:inst (for DRUM)	01
	nn 07	1	00..02	Part Mode	0:normal 1:drum (ROM) 2-3:drum (RAM)	00 (other than Part10) 01 (Part10)
	nn 08	1	28..58	Note Shift	-24..+24[semitones]	40
	nn 09	2	00..FF	Detune	-12.8..+12.7[Hz]	08 00
	nn 0A				1st bit3..0 → bit7..4 2nd bit3..0 → bit3..0	-80
	nn 0B	1	00..7F	Volume	0..127	64
	nn 0C	1	00..7F	Velocity Sense Depth	0..127	40
	nn 0D	1	00..7F	Velocity Sense Offset	0..127	40
	nn 0E	1	00..7F	Pan	0:random L63..C..R63(1..64..127)	40
	nn 0F	1	00..7F	Note Limit Low	C-2..G8	00
	nn 10	1	00..7F	Note Limit High	C-2..G8	7F
	nn 11	1	00..7F	Dry Level	0..127	7F
	nn 12	1	00..7F	Chorus Send	0..127	00
	nn 13	1	00..7F	Reverb Send	0..127	28
	nn 14	1	00..7F	Variation Send	0..127	00
	nn 15	1	00..7F	Vibrato Rate	-64..+63	40
	nn 16	1	00..7F	Vibrato Depth	-64..+63	40
	nn 17	1	00..7F	Vibrato Delay	-64..+63	40
	nn 18	1	00..7F	Filter Cutoff Freq.	-64..+63	40
	nn 19	1	00..7F	Filter Resonance	-64..+63	40
	nn 1A	1	00..7F	EG Attack Time	-64..+63	40
	nn 1B	1	00..7F	EG Decay Time	-64..+63	40
	nn 1C	1	00..7F	EG Release Time	-64..+63	40
	nn 1D	1	28..58	MW Pitch Control	-24..+24[semitones]	40
	nn 1E	1	00..7F	MW Filter Control	-9600..+9450[cent]	40
	nn 1F	1	00..7F	MW Amp. Control	-100..+100[%]	40
	nn 20	1	00..7F	MW LFO PMod Depth	0..127	0A
	nn 21	1	00..7F	MW LFO FMod Depth	0..127	00
	nn 22	1	00..7F	MW LFO AMod Depth	0..127	00
	nn 23	1	28..58	Bend Pitch Control	-24..+24[semitones]	42
	nn 24	1	00..7F	Bend Filter Control	-9600..+9450[cent]	40
	nn 25	1	00..7F	Bend Amp. Control	-100..+100[%]	40
	nn 26	1	00..7F	Bend LFO PMod Depth	0..127	00
	nn 27	1	00..7F	Bend LFO FMod Depth	0..127	00
	nn 28	1	00..7F	Bend LFO AMod Depth	0..127	00
TOTAL SIZE 29						
	nn 30			Not Used		
	:			:		
	nn 40			Not Used		
	nn 41	1	00..7F	Scale Tuning C	-64..+63[cent]	40
	nn 42	1	00..7F	Scale Tuning C#	-64..+63[cent]	40
	nn 43	1	00..7F	Scale Tuning D	-64..+63[cent]	40
	nn 44	1	00..7F	Scale Tuning D#	-64..+63[cent]	40
	nn 45	1	00..7F	Scale Tuning E	-64..+63[cent]	40
	nn 46	1	00..7F	Scale Tuning F	-64..+63[cent]	40
	nn 47	1	00..7F	Scale Tuning F#	-64..+63[cent]	40
	nn 48	1	00..7F	Scale Tuning G	-64..+63[cent]	40
	nn 49	1	00..7F	Scale Tuning G#	-64..+63[cent]	40
	nn 4A	1	00..7F	Scale Tuning A	-64..+63[cent]	40
	nn 4B	1	00..7F	Scale Tuning A#	-64..+63[cent]	40
	nn 4C	1	00..7F	Scale Tuning B	-64..+63[cent]	40
	nn 4D	1	28..58	CAT Pitch Control	-24..+24[semitones]	40
	nn 4E	1	00..7F	CAT Filter Control	-9600..+9450[cent]	40
	nn 4F	1	00..7F	CAT Amplitude Control	-100..+100[%]	40
	nn 50	1	00..7F	CAT LFO PMod Depth	0..127	00
	nn 51	1	00..7F	CAT LFO FMod Depth	0..127	00
	nn 52	1	00..7F	CAT LFO AMod Depth	0..127	00
	nn 53			Not Used		
	:			:		
	66			Not Used		
	nn 67	1	00..01	Portamento Switch	off/on	00
	nn 68	1	00..7F	Portamento Time	0..127	00
	nn 69			Not Used		
	:			:		
	6E			Not Used		
TOTAL SIZE 3F						

nn = PartNumber

If there is a Drum Voice assigned to the Part, the following parameters are ineffective.

- Bank Select LSB
- Pitch EG
- Portamento
- Soft Pedal
- Mono/Poly
- Scale Tuning

MIDI Data Format

< Table 1-6 > MIDI Parameter Change table (DRUM SETUP)

Address (H)	Size (H)	Data (H)	Parameter Name	Description (H)	Default Value (H)
3n rr 00	1	00..7F	Pitch Coarse	-64..+63	40
3n rr 01	1	00..7F	Pitch Fine	-64..+63[cent]	40
3n rr 02	1	00..7F	Level	0..127	Depend on the Note
3n rr 03	1	00..7F	Alternate Group	0:off,1..127	Depend on the Note
3n rr 04	1	00..7F	Pan	0:random L63..C..R63(1..64..127)	Depend on the Note
3n rr 05	1	00..7F	Reverb Send Level	0..127	Depend on the Note
3n rr 06	1	00..7F	Chorus Send Level	0..127	Depend on the Note
3n rr 07	1	00..7F	Variation Send Level	0..127	7F
3n rr 08	1	00..01	Key Assign	0:single,1:multi	00
3n rr 09	1	00..01	Rcv Note Off	off/on	Depend on the Note
3n rr 0A	1	00..01	Rcv Note On	off/on	01
3n rr 0B	1	00..7F	Filter Cutoff Freq.	-64..63	40
3n rr 0C	1	00..7F	Filter Resonance	-64..63	40
3n rr 0D	1	00..7F	EG Attack Rate	-64..63	40
3n rr 0E	1	00..7F	EG Decay1 Rate	-64..63	40
3n rr 0F	1	00..7F	EG Decay2 Rate	-64..63	40

TOTAL SIZE 10

n:Drum Setup Number(0 - 1)

rr:note number(0DH - 5BH)

If XG SYSTEM ON and/or GM On message is received, all Drum Setup Parameter will be reset to default values.

According to the Drum Setup Reset message, individual Drum Setup Parameters can be reset to default values.

< Table 1-7 > Effect Type List

	XG ESSENTIAL EFFECT
	Same as LSB=0
	XG OPTION EFFECT
	Expanded type for PSR-550

* If the received value does not contain an effect type in the TYPE LSB, the LSB will be directed to TYPE 0.

* Panel Effects are based on the "[Number] Effect Name".

REVERB TYPE

TYPE MSB		TYPE LSB	01	02	03...07	08	09...15	16	17	18	19	20						
DEC	HEX	00																
000	00	NO EFFECT																
001	01	[1]HALL1	[5]HALL2									[2]HALL2	[3]HALL3	[4]HALL4				
002	02	[10]ROOM1	[11]ROOM2	[12]ROOM3									[6]ROOM1	[7]ROOM2	[8]ROOM3	[9]ROOM4		
003	03	[15]STAGE1	[16]STAGE2									[13]STAGE1	[14]STAGE2					
004	04	[19]PLATE									[17]PLATE1	[18]PLATE2						
005	05	NO EFFECT																
:	:	:																
015	0F	NO EFFECT																
016	10	[20]WHITE ROOM																
017	11	[21]TUNNEL																
018	12	[22]CANYON																
019	13	[23]BASEMENT																
020	14	NO EFFECT																
:	:	:																
127	7F	NO EFFECT																

CHORUS TYPE

TYPE MSB		TYPE LSB	01	02	03...07	08	09...15	16	17	18	19	20				
DEC	HEX	00														
000	00	NO EFFECT														
001	01	NO EFFECT														
:	:	:														
064	40	NO EFFECT														
065	41	[6]CHORUS1	[7]CHORUS2	[5]CHORUS5				[8]CHORUS4								
066	42	[9]CELESTE1	[4]CHORUS4	[10]CELESTE3				[2]CHORUS2	[3]CHORUS3	[1]CHORUS1						
067	43	[15]FLANGER 1	[14]FLANGER 4									[11]FLANGER1	[12]FLANGER2	[13]FLANGER3		
068	44	NO EFFECT														
:	:	:														
127	7F	NO EFFECT														

VARIATION TYPE(0-63)

TYPE MSB		TYPE LSB	01	02	03...07	08	09...15	16	17	18	19	20						
DEC	HEX	00																
000	00	NO EFFECT																
001	01	[1]HALL1	[5]HALL2									[2]HALL2	[3]HALL3	[4]HALL4				
002	02	[10]ROOM1	[11]ROOM2	[12]ROOM3									[6]ROOM1	[7]ROOM2	[8]ROOM3	[9]ROOM4		
003	03	[15]STAGE1	[16]STAGE2									[13]STAGE1	[14]STAGE2					
004	04	[19]PLATE									[17]PLATE1	[18]PLATE2						
005	05	[21]DELAY L.C.R									[20]Delay LCR							
006	06	[22]DELAY L.R																
007	07	[23]ECHO																
008	08	[24]CROSS DELAY																
009	09	[25]ER1	[26]ER2															
010	0A	[27]GATE REVERB																
011	0B	[28]REVERS GATE																
012	0C	NO EFFECT or THRU*																
:	:	:																
019	13	NO EFFECT or THRU*																
020	14	[29]KARAOKE 1	[30]KARAOKE 2	[31]KARAOKE 3														
021	15	NO EFFECT or THRU*																
:	:	:																
063	3F	NO EFFECT or THRU*																

* No effect when Effect Connection = System.

Through when Effect Connection = Insertion.

VARIATION TYPE (64-127)

TYPE MSB		TYPE LSB	01	02	03...07	08	09...15	16	17	18	19	20			
DEC	HEX	00													
064	40	THRU													
065	41	[37]CHORUS1	[38]CHORUS2	[36]CHORUS5				[39]CHORUS4	[32]CHORUS1	[53]Rotary Sp5					
066	42	[40]CELESTE1	[35]CHORUS4	[41]CELESTE3				[33]CHORUS2	[34]CHORUS3	[44]FLANGER3					
067	43	[46]FLANGER 1	[45]FLANGER 4									[42]FLANGER1	[47]Symphonic		
068	44	[48]SYMPHONIC									[49]Rotary Sp1				
069	45	[54]ROTARY SP.									[55]Tremolo1	[52]Rotary Sp4			
070	46	[57]TREMLOLO									[36]AutoPan	[50]Rotary Sp2	[51]Rotary Sp3	[56]Tremolo2	[58]Gtr Tremolo
071	47	[60]AUTO PAN									[62]PHASER 2				
072	48	[61]PHASER													
073	49	[65]DISTORTION													
074	4A	[66]OVER DRIVE													
075	4B	[67]AMP SIM.									[63]DIST.HARD	[64]DIST.SOFT			
076	4C	[70]3BAND EQ									[68]EQ DISCO	[69]EQ TEL			
077	4D	[71]2BAND EQ													
078	4E	[73]AUTO WAH									[72]Auto Wah				
079	4F	THRU													
:	:	:													
127	7F	THRU													

< Table 1-8 > Effect Parameter List

HALL1,HALL2,ROOM1,ROOM2,ROOM3, STAGE1,STAGE2, PLATE (reverb, variation block)

No.	Parameter	Display	Value	See Table	Control
1	Reverb Time	0.3-30.0s	0-69	table#4	
2	Diffusion	0-10	0-10		
3	Initial Delay	0.1mS-99.3mS	0-63	table#5	
4	HPF Cutoff	Thru-8.0kHz	0-52	table#3	
5	LPF Cutoff	1.0k-Thru	34-60	table#3	
6					
7					
8					
9					
10	Dry/Wet	D63>W - D=W - D<W63	1-127		●
11	Rev Delay	0.1mS-99.3mS	0-63	table#5	
12	Density	0-4	0-3		
13	Err/Rev Balance	E63>R - E=R - E<R63	1-127		
14					
15	Feedback Level	-63+63	1-127		
16					

CROSS DELAY (variation block)

No.	Parameter	Display	Value	See Table	Control
1	L->R Delay	0.1-355.0ms	1-3550		
2	R->L Delay	0.1-355.0ms	1-3550		
3	Feedback Level	-63+63	1-127		
4	Input Select	L,R,L&R	0-2		
5	High Damp	0.1-1.0	1-10		
6					
7					
8					
9					
10	Dry/Wet	D63>W - D=W - D<W63	1-127		●
11					
12					
13	EQ Low Frequency	50Hz-2.0kHz	8-40	table#3	
14	EQ Low Gain	-12+12dB	52-76		
15	EQ High Frequency	500Hz-16.0kHz	28-58	table#3	
16	EQ High Gain	-12+12dB	52-76		

WHITE ROOM, TUNNEL, CANYON, BASEMENT (reverb, variation block)

No.	Parameter	Display	Value	See Table	Control
1	Reverb Time	0.3-30.0s	0-69	table#4	
2	Diffusion	0-10	0-10		
3	Initial Delay	0.1mS-99.3mS	0-63	table#5	
4	HPF Cutoff	Thru-8.0kHz	0-52	table#3	
5	LPF Cutoff	1.0k-Thru	34-60	table#3	
6	Width	0.5-10.2m	0-37	table#8	
7	Height	0.5-20.2m	0-73	table#8	
8	Depth	0.5-30.2m	0-104	table#8	
9	Wall Vary	0-30	0-30		
10	Dry/Wet	D63>W - D=W - D<W63	1-127		●
11	Rev Delay	0.1mS-99.3mS	0-63	table#5	
12	Density	0-4	0-3		
13	Err/Rev Balance	E63>R - E=R - E<R63	1-127		
14					
15	Feedback Level	-63+63	1-127		
16					

EARLY REF1,EARLY REF2(variation block)

No.	Parameter	Display	Value	See Table	Control
1	Type	S-H, L-H, Rdm, Rvs, Ptt, Spr	0-5		
2	Room Size	0.1-7.0	0-44	table#6	
3	Diffusion	0-10	0-10		
4	Initial Delay	0.1mS-99.3mS	0-63	table#5	
5	Feedback Level	-63+63	1-127		
6	HPF Cutoff	Thru-8.0kHz	0-52	table#3	
7	LPF Cutoff	1.0k-Thru	34-60	table#3	
8					
9					
10	Dry/Wet	D63>W - D=W - D<W63	1-127		●
11	Liveness	0-10	0-10		
12	Density	0-3	0-3		
13	High Damp	0.1-1.0	1-10		
14					
15					
16					

DELAY L,C,R (variation block)

No.	Parameter	Display	Value	See Table	Control
1	Lch Delay	0.1-715.0ms	1-7150		
2	Rch Delay	0.1-715.0ms	1-7150		
3	Cch Delay	0.1-715.0ms	1-7150		
4	Feedback Delay	0.1-715.0ms	1-7150		
5	Feedback Level	-63+63	1-127		
6	Cch Level	0-127	0-127		
7	High Damp	0.1-1.0	1-10		
8					
9					
10	Dry/Wet	D63>W - D=W - D<W63	1-127		●
11					
12					
13	EQ Low Frequency	50Hz-2.0kHz	8-40	table#3	
14	EQ Low Gain	-12+12dB	52-76		
15	EQ High Frequency	500Hz-16.0kHz	28-58	table#3	
16	EQ High Gain	-12+12dB	52-76		

GATE REVERB, REVERSE GATE (variation block)

No.	Parameter	Display	Value	See Table	Control
1	Type	TypeA, TypeB	0-1		
2	Room Size	0.1-20.0	0-127	table#6	
3	Diffusion	0-10	0-10		
4	Initial Delay	0.1mS-200.0mS	0-127	table#5	
5	Feedback Level	-63+63	1-127		
6	HPF Cutoff	Thru-8.0kHz	0-52	table#3	
7	LPF Cutoff	1.0k-Thru	34-60	table#3	
8					
9					
10	Dry/Wet	D63>W - D=W - D<W63	1-127		●
11	Liveness	0-10	0-10		
12	Density	0-3	0-3		
13	High Damp	0.1-1.0	1-10		
14					
15					
16					

DELAY L,R (variation block)

No.	Parameter	Display	Value	See Table	Control
1	Lch Delay	0.1-715.0ms	1-7150		
2	Rch Delay	0.1-715.0ms	1-7150		
3	Feedback Delay 1	0.1-715.0ms	1-7150		
4	Feedback Delay 2	0.1-715.0ms	1-7150		
5	Feedback Level	-63+63	1-127		
6	High Damp	0.1-1.0	1-10		
7					
8					
9					
10	Dry/Wet	D63>W - D=W - D<W63	1-127		●
11					
12					
13	EQ Low Frequency	50Hz-2.0kHz	8-40	table#3	
14	EQ Low Gain	-12+12dB	52-76		
15	EQ High Frequency	500Hz-16.0kHz	28-58	table#3	
16	EQ High Gain	-12+12dB	52-76		

KARAOKE1,2,3 (variation block)

No.	Parameter	Display	Value	See Table	Control
1	Delay Time	0.1mS-400.0mS	0-127	table#7	
2	Feedback Level	-63+63	1-127		
3	HPF Cutoff	Thru-8.0kHz	0-52	table#3	
4	LPF Cutoff	1.0k-Thru	34-60	table#3	
5					
6					
7					
8					
9					
10	Dry/Wet	D63>W - D=W - D<W63	1-127		●
11					
12					
13					
14					
15					
16					

ECHO (variation block)

No.	Parameter	Display	Value	See Table	Control
1	Lch Delay1	0.1-355.0ms	1-3550		
2	Lch Feedback Level	-63+63	1-127		
3	Rch Delay1	0.1-355.0ms	1-3550		
4	Rch Feedback Level	-63+63	1-127		
5	High Damp	0.1-1.0	1-10		
6	Lch Delay2	0.1-355.0ms	1-3550		
7	Rch Delay2	0.1-355.0ms	1-3550		
8	Delay2 Level	0-127	0-127		
9					
10	Dry/Wet	D63>W - D=W - D<W63	1-127		●
11					
12					
13	EQ Low Frequency	50Hz-2.0kHz	8-40	table#3	
14	EQ Low Gain	-12+12dB	52-76		
15	EQ High Frequency	500Hz-16.0kHz	28-58	table#3	
16	EQ High Gain	-12+12dB	52-76		

CHORUS1,2,3,4, CELESTE1,2,3,4 (chorus, variation block)

No.	Parameter	Display	Value	See Table	Control
1	LFO Frequency	0.00Hz-39.7Hz	0-127	table#1	
2	LFO Depth	0-127	0-127		
3	Feedback Level	-63+63	1-127		
4	Delay Offset	0.0mS-50mS	0-127	table#2	
5					
6	EQ Low Frequency	50Hz-2.0kHz	8-40	table#3	
7	EQ Low Gain	-12+12dB	52-76		
8	EQ High Frequency	500Hz-16.0kHz	28-58	table#3	
9	EQ High Gain	-12+12dB	52-76		
10	Dry/Wet	D63>W - D=W - D<W63	1-127		●
11					
12					
13					
14					
15	Input Mode	mono/stereo	0-1		
16					

MIDI Data Format

FLANGER1,2,3 (chorus, variation block)

No.	Parameter	Display	Value	See Table	Control
1	LFO Frequency	0.00Hz-39.7Hz	0-127	table#1	
2	LFO Depth	0-127	0-127		
3	Feedback Level	-63+63	1-127		
4	Delay Offset	0.0mS-50mS	0-127	table#2	
5					
6	EQ Low Frequency	50Hz-2.0kHz	8-40	table#3	
7	EQ Low Gain	-12+12dB	52-76		
8	EQ High Frequency	500Hz-16.0kHz	28-58	table#3	
9	EQ High Gain	-12+12dB	52-76		
10	Dry/Wet	D63>W - D=W - D<W63	1-127		●
11					
12					
13					
14	LFO Phase Difference	-180+180deg (resolution=3deg.)	4-124		
15					
16					

SYMPHONIC (chorus, variation block)

No.	Parameter	Display	Value	See Table	Control
1	LFO Frequency	0.00Hz-39.7Hz	0-127	table#1	
2	LFO Depth	0-127	0-127		
3	Delay Offset	0.0mS-50mS	0-127	table#2	
4					
5					
6	EQ Low Frequency	50Hz-2.0kHz	8-40	table#3	
7	EQ Low Gain	-12+12dB	52-76		
8	EQ High Frequency	500Hz-16.0kHz	28-58	table#3	
9	EQ High Gain	-12+12dB	52-76		
10	Dry/Wet	D63>W - D=W - D<W63	1-127		●
11					
12					
13					
14					
15					
16					

ROTARY SPEAKER (variation block)

No.	Parameter	Display	Value	See Table	Control
1	LFO Frequency	0.00Hz-39.7Hz	0-127	table#1	●
2	LFO Depth	0-127	0-127		
3					
4					
5					
6	EQ Low Frequency	50Hz-2.0kHz	8-40	table#3	
7	EQ Low Gain	-12+12dB	52-76		
8	EQ High Frequency	500Hz-16.0kHz	28-58	table#3	
9	EQ High Gain	-12+12dB	52-76		
10	Dry/Wet	D63>W - D=W - D<W63	1-127		
11					
12					
13					
14					
15					
16					

TREMOLO (variation block)

No.	Parameter	Display	Value	See Table	Control
1	LFO Frequency	0.00Hz-39.7Hz	0-127	table#1	●
2	AM Depth	0-127	0-127		
3	PM Depth	0-127	0-127		
4					
5					
6	EQ Low Frequency	50Hz-2.0kHz	8-40	table#3	
7	EQ Low Gain	-12+12dB	52-76		
8	EQ High Frequency	500Hz-16.0kHz	28-58	table#3	
9	EQ High Gain	-12+12dB	52-76		
10					
11					
12					
13					
14	LFO Phase Difference	-180+180deg (resolution=3deg.)	4-124		
15	Input Mode	mono/stereo	0-1		
16					

AUTO PAN (variation block)

No.	Parameter	Display	Value	See Table	Control
1	LFO Frequency	0.00Hz-39.7Hz	0-127	table#1	●
2	L/R Depth	0-127	0-127		
3	F/R Depth	0-127	0-127		
4	PAN Direction	L<->R,L->R,L<-R,Lturn,Rturn,L/R	0-5		
5					
6	EQ Low Frequency	50Hz-2.0kHz	8-40	table#3	
7	EQ Low Gain	-12+12dB	52-76		
8	EQ High Frequency	500Hz-16.0kHz	28-58	table#3	
9	EQ High Gain	-12+12dB	52-76		
10					
11					
12					
13					
14					
15					
16					

PHASER 1 (chorus, variation block)

No.	Parameter	Display	Value	See Table	Control
1	LFO Frequency	0.00Hz-39.7Hz	0-127	table#1	
2	LFO Depth	0-127	0-127		
3	Phase Shift Offset	0-127	0-127		
4	Feedback Level	-63+63	1-127		
5					
6	EQ Low Frequency	50Hz-2.0kHz	8-40	table#3	
7	EQ Low Gain	-12+12dB	52-76		
8	EQ High Frequency	500Hz-16.0kHz	28-58	table#3	
9	EQ High Gain	-12+12dB	52-76		
10	Dry/Wet	D63>W - D=W - D<W63	1-127		●
11	Stage	4,5,6 (chorus block) 6-10 (variation block)	4-6 6-10		
12					
13					
14					
15					
16					

PHASER 2 (variation block)

No.	Parameter	Display	Value	See Table	Control
1	LFO Frequency	0.00Hz-39.7Hz	0-127	table#1	
2	LFO Depth	0-127	0-127		
3	Phase Shift Offset	0-127	0-127		
4	Feedback Level	-63+63	1-127		
5					
6	EQ Low Frequency	50Hz-2.0kHz	8-40	table#3	
7	EQ Low Gain	-12+12dB	52-76		
8	EQ High Frequency	500Hz-16.0kHz	28-58	table#3	
9	EQ High Gain	-12+12dB	52-76		
10	Dry/Wet	D63>W - D=W - D<W63	1-127		●
11	Stage	3,4,5	3-5		
12					
13	LFO Phase Difference	-180deg+180deg (resolution=3deg.)	4-124		
14					
15					
16					

DISTORTION, OVERDRIVE (variation block)

No.	Parameter	Display	Value	See Table	Control
1	Drive	0-127	0-127		●
2	EQ Low Frequency	50Hz-2.0kHz	8-40	table#3	
3	EQ Low Gain	-12+12dB	52-76		
4	LPF Cutoff	1.0k-Thru	34-60	table#3	
5	Output Level	0-127	0-127		
6					
7	EQ Mid Frequency	500Hz-10.0kHz	28-54	table#3	
8	EQ Mid Gain	-12+12dB	52-76		
9	EQ Mid Width	1.0-12.0	10-120		
10	Dry/Wet	D63>W - D=W - D<W63	1-127		
11	Edge (Clip Curve)	0-127	0-127	mild-sharp	
12					
13					
14					
15					
16					

AMP SIMULATOR (variation block)

No.	Parameter	Display	Value	See Table	Control
1	Drive	0-127	0-127		●
2	AMP Type	Off,Stack,Combo,Tube	0-3		
3	LPF Cutoff	1.0k-Thru	34-60	table#3	
4	Output Level	0-127	0-127		
5					
6					
7					
8					
9					
10	Dry/Wet	D63>W - D=W - D<W63	1-127		
11	Edge(Clip Curve)	0-127	0-127	mild-sharp	
12					
13					
14					
15					
16					

3BAND EQ(MONO) (variation block)

No.	Parameter	Display	Value	See Table	Control
1	EQ Low Gain	-12+12dB	52-76		
2	EQ Mid Frequency	500Hz-10.0kHz	28-54	table#3	
3	EQ Mid Gain	-12+12dB	52-76		
4	EQ Mid Width	1.0-12.0	10-120		
5	EQ High Gain	-12+12dB	52-76		
6	EQ Low Frequency	50Hz-2.0kHz	8-40	table#3	
7	EQ High Frequency	500Hz-16.0kHz	28-58	table#3	
8					
9					
10					
11					
12					
13					
14					
15	Input Mode	mono/stereo	0-1		
16					

2BAND EQ(STEREO) (variation block)

No.	Parameter	Display	Value	See Table	Control
1	EQ Low Frequency	50Hz-2.0kHz	8-40	table#3	
2	EQ Low Gain	-12+12dB	52-76		
3	EQ High Frequency	500Hz-16.0kHz	28-58		
4	EQ High Gain	-12+12dB	52-76		
5					
6					
7					
8					
9					
10					
11					
12					
13					
14					
15					
16					

AUTO WAH (variation block)

No.	Parameter	Display	Value	See Table	Control
1	LFO Frequency	0.00Hz-39.7Hz	0-127	table#1	●
2	LFO Depth	0-127	0-127		
3	Cutoff Frequency Offset	0-127	0-127		
4	Resonance	1.0-12.0	10-120		
5					
6	EQ Low Frequency	50Hz-2.0kHz	8-40	table#3	
7	EQ Low Gain	-12+12dB	52-76		
8	EQ High Frequency	500Hz-16.0kHz	28-58	table#3	
9	EQ High Gain	-12+12dB	52-76		
10	Dry/Wet	D63>W - D=W - D<W63	1-127		
11					
12					
13					
14					
15					
16					

NO EFFECT (reverb, chorus, variation block), THRU (variation block)

No.	Parameter	Display	Value	See Table	Control
1					
2					
3					
4					
5					
6					
7					
8					
9					
10					
11					
12					
13					
14					
15					
16					

MIDI Data Format

< Table 1-9 > Effect Data Value Assign Table

Table#1
LFO Frequency

Data	Value	Data	Value	Data	Value	Data	Value
0	0.00	32	1.35	64	2.69	96	8.41
1	0.04	33	1.39	65	2.78	97	8.75
2	0.08	34	1.43	66	2.86	98	9.08
3	0.13	35	1.47	67	2.94	99	9.42
4	0.17	36	1.51	68	3.03	100	9.76
5	0.21	37	1.56	69	3.11	101	10.1
6	0.25	38	1.60	70	3.20	102	10.8
7	0.29	39	1.64	71	3.28	103	11.4
8	0.34	40	1.68	72	3.37	104	12.1
9	0.38	41	1.72	73	3.45	105	12.8
10	0.42	42	1.77	74	3.53	106	13.5
11	0.46	43	1.81	75	3.62	107	14.1
12	0.51	44	1.85	76	3.70	108	14.8
13	0.55	45	1.89	77	3.87	109	15.5
14	0.59	46	1.94	78	4.04	110	16.2
15	0.63	47	1.98	79	4.21	111	16.8
16	0.67	48	2.02	80	4.37	112	17.5
17	0.72	49	2.06	81	4.54	113	18.2
18	0.76	50	2.10	82	4.71	114	19.5
19	0.80	51	2.15	83	4.88	115	20.9
20	0.84	52	2.19	84	5.05	116	22.2
21	0.88	53	2.23	85	5.22	117	23.6
22	0.93	54	2.27	86	5.38	118	24.9
23	0.97	55	2.31	87	5.55	119	26.2
24	1.01	56	2.36	88	5.72	120	27.6
25	1.05	57	2.40	89	6.06	121	28.9
26	1.09	58	2.44	90	6.39	122	30.3
27	1.14	59	2.48	91	6.73	123	31.6
28	1.18	60	2.52	92	7.07	124	33.0
29	1.22	61	2.57	93	7.40	125	34.3
30	1.26	62	2.61	94	7.74	126	37.0
31	1.30	63	2.65	95	8.08	127	39.7

Table#4
Reverb time

Data	Value	Data	Value	Data	Value	Data	Value
0	0.3	32	3.5	64	17.0		
1	0.4	33	3.6	65	18.0		
2	0.5	34	3.7	66	19.0		
3	0.6	35	3.8	67	20.0		
4	0.7	36	3.9	68	25.0		
5	0.8	37	4.0	69	30.0		
6	0.9	38	4.1				
7	1.0	39	4.2				
8	1.1	40	4.3				
9	1.2	41	4.4				
10	1.3	42	4.5				
11	1.4	43	4.6				
12	1.5	44	4.7				
13	1.6	45	4.8				
14	1.7	46	4.9				
15	1.8	47	5.0				
16	1.9	48	5.5				
17	2.0	49	6.0				
18	2.1	50	6.5				
19	2.2	51	7.0				
20	2.3	52	7.5				
21	2.4	53	8.0				
22	2.5	54	8.5				
23	2.6	55	9.0				
24	2.7	56	9.5				
25	2.8	57	10.0				
26	2.9	58	11.0				
27	3.0	59	12.0				
28	3.1	60	13.0				
29	3.2	61	14.0				
30	3.3	62	15.0				
31	3.4	63	16.0				

Table#7
Delay Time(400.0ms)

Data	Value	Data	Value	Data	Value	Data	Value
0	0.1	32	100.9	64	201.6	96	302.4
1	3.2	33	104.0	65	204.8	97	305.5
2	6.4	34	107.2	66	207.9	98	308.7
3	9.5	35	110.3	67	211.1	99	311.8
4	12.7	36	113.5	68	214.2	100	315.0
5	15.8	37	116.6	69	217.4	101	318.1
6	19.0	38	119.8	70	220.5	102	321.3
7	22.1	39	122.9	71	223.7	103	324.4
8	25.3	40	126.1	72	226.8	104	327.6
9	28.4	41	129.2	73	230.0	105	330.7
10	31.6	42	132.4	74	233.1	106	333.9
11	34.7	43	135.5	75	236.3	107	337.0
12	37.9	44	138.6	76	239.4	108	340.2
13	41.0	45	141.8	77	242.6	109	343.3
14	44.2	46	144.9	78	245.7	110	346.5
15	47.3	47	148.1	79	248.9	111	349.6
16	50.5	48	151.2	80	252.0	112	352.8
17	53.6	49	154.4	81	255.2	113	355.9
18	56.8	50	157.5	82	258.3	114	359.1
19	59.9	51	160.7	83	261.5	115	362.2
20	63.1	52	163.8	84	264.6	116	365.4
21	66.2	53	167.0	85	267.7	117	368.5
22	69.4	54	170.1	86	270.9	118	371.7
23	72.5	55	173.3	87	274.0	119	374.8
24	75.7	56	176.4	88	277.2	120	378.0
25	78.8	57	179.6	89	280.3	121	381.1
26	82.0	58	182.7	90	283.5	122	384.3
27	85.1	59	185.9	91	286.6	123	387.4
28	88.3	60	189.0	92	289.8	124	390.6
29	91.4	61	192.2	93	292.9	125	393.7
30	94.6	62	195.3	94	296.1	126	396.9
31	97.7	63	198.5	95	299.2	127	400.0

Table#2
Modulation Delay Offset

Data	Value	Data	Value	Data	Value	Data	Value
0	0.0	32	3.2	64	6.4	96	9.6
1	0.1	33	3.3	65	6.5	97	9.7
2	0.2	34	3.4	66	6.6	98	9.8
3	0.3	35	3.5	67	6.7	99	9.9
4	0.4	36	3.6	68	6.8	100	10.0
5	0.5	37	3.7	69	6.9	101	11.1
6	0.6	38	3.8	70	7.0	102	12.2
7	0.7	39	3.9	71	7.1	103	13.3
8	0.8	40	4.0	72	7.2	104	14.4
9	0.9	41	4.1	73	7.3	105	15.5
10	1.0	42	4.2	74	7.4	106	17.1
11	1.1	43	4.3	75	7.5	107	18.6
12	1.2	44	4.4	76	7.6	108	20.2
13	1.3	45	4.5	77	7.7	109	21.8
14	1.4	46	4.6	78	7.8	110	23.3
15	1.5	47	4.7	79	7.9	111	24.9
16	1.6	48	4.8	80	8.0	112	26.5
17	1.7	49	4.9	81	8.1	113	28.0
18	1.8	50	5.0	82	8.2	114	29.6
19	1.9	51	5.1	83	8.3	115	31.2
20	2.0	52	5.2	84	8.4	116	32.8
21	2.1	53	5.3	85	8.5	117	34.3
22	2.2	54	5.4	86	8.6	118	35.9
23	2.3	55	5.5	87	8.7	119	37.5
24	2.4	56	5.6	88	8.8	120	39.0
25	2.5	57	5.7	89	8.9	121	40.6
26	2.6	58	5.8	90	9.0	122	42.2
27	2.7	59	5.9	91	9.1	123	43.7
28	2.8	60	6.0	92	9.2	124	45.3
29	2.9	61	6.1	93	9.3	125	46.9
30	3.0	62	6.2	94	9.4	126	48.4
31	3.1	63	6.3	95	9.5	127	50.0

Table#5
Delay Time(200.0ms)

Data	Value	Data	Value	Data	Value	Data	Value
0	0.1	32	50.5	64	100.8	96	151.2
1	1.7	33	52.0	65	102.4	97	152.8
2	3.2	34	53.6	66	104.0	98	154.4
3	4.8	35	55.2	67	105.6	99	155.9
4	6.4	36	56.8	68	107.1	100	157.5
5	8.0	37	58.3	69	108.7	101	159.1
6	9.5	38	59.9	70	110.3	102	160.6
7	11.1	39	61.5	71	111.9	103	162.2
8	12.7	40	63.1	72	113.4	104	163.8
9	14.3	41	64.6	73	115.0	105	165.4
10	15.8	42	66.2	74	116.6	106	166.9
11	17.4	43	67.8	75	118.2	107	168.5
12	19.0	44	69.4	76	119.7	108	170.1
13	20.6	45	70.9	77	121.3	109	171.7
14	22.1	46	72.5	78	122.9	110	173.2
15	23.7	47	74.1	79	124.4	111	174.8
16	25.3	48	75.7	80	126.0	112	176.4
17	26.9	49	77.2	81	127.6	113	178.0
18	28.4	50	78.8	82	129.2	114	179.5
19	30.0	51	80.4	83	130.7	115	181.1
20	31.6	52	81.9	84	132.3	116	182.7
21	33.2	53	83.5	85	133.9	117	184.3
22	34.7	54	85.1	86	135.5	118	185.8
23	36.3	55	86.7	87	137.0	119	187.4
24	37.9	56	88.2	88	138.6	120	189.0
25	39.5	57	89.8	89	140.2	121	190.6
26	41.0	58	91.4	90	141.8	122	192.1
27	42.6	59	93.0	91	143.3	123	193.7
28	44.2	60	94.5	92	144.9	124	195.3
29	45.7	61	96.1	93	146.5	125	196.9
30	47.3	62	97.7	94	148.1	126	198.4
31	48.9	63	99.3	95	149.6	127	200.0

Table#8
Reverb Width:Depth:Height

Data	Value	Data	Value	Data	Value	Data	Value
0	0.5	32	8.8	64	17.6	96	27.5
1	0.8	33	9.1	65	17.9	97	27.8
2	1.0	34	9.4	66	18.2	98	28.1
3	1.3	35	9.6	67	18.5	99	28.5
4	1.5	36	9.9	68	18.8	100	28.8
5	1.8	37	10.2	69	19.1	101	29.2
6	2.0	38	10.4	70	19.4	102	29.5
7	2.3	39	10.7	71	19.7	103	29.9
8	2.6	40	11.0	72	20.0	104	30.2
9	2.8	41	11.2	73	20.2		
10	3.1	42	11.5	74	20.5		
11	3.3	43	11.8	75	20.8		
12	3.6	44	12.1	76	21.1		
13	3.9	45	12.3	77	21.4</		

MIDI Implementation Chart

[Portable Keyboard]
Model : PSR-550

MIDI Implementation Chart

Date : 30-NOV-2000
Version : 1.0

Function...	Transmitted	Recognized	Remarks
Basic Default Channel Changed	1 - 16 *1 1 - 16 *1	1 - 16 *2 1 - 16 *2	
Mode Default Messages Altered	3 x *****	3 x x	
Note Number : True voice	0 - 127 *****	0 - 127 0 - 127	
Velocity Note ON Note OFF	o 9nH,v=1-127 x 9nH,v=0	o 9nH,v=1-127 x	
After Key's Touch Ch's	x x	x o	
Pitch Bend	o	o	
Control Change	0,32 o 1,5,11 x 7,10 o 6,38 o 64,66-67 o 65 x 72 o 71,73-74 x 84 x 91,93-94 o 96-97 x 98-99 x 100-101 o	o o o o o o o o o o o o o o	Bank Select Data Entry Portamento Sound Controller Sound Controller Portament Cntrl Effect SendLevel Data Inc,Dec NRPN LSB,MSB RPN LSB,MSB
Prog Change : True #	o 0 - 127 *****	o 0 - 127	
System Exclusive	o	o	
: Song Pos. Common : Song Sel. : Tune	x x x	x x x	
System : Clock Real Time : Commands	o o	o o	
Aux : All Sound Off : Reset All Cntrls : Local ON/OFF Mes- : All Notes OFF sages : Active Senseo : Reset	x x x x o x	o o x o (123-127) x	

Mode 1 : OMNI ON, POLY Mode 2 : OMNI ON, MONO
Mode 3 : OMNI OFF, POLY Mode 4 : OMNI OFF, MONO

o : Yes
x : No

MIDI Implementation Chart

- *1 The tracks for each channel can be selected on the panel.
See page 114 for more information.
- *2 Incoming MIDI messages control the PSR-550 as 16 channel multi timbral tone generator when initially shipped (factory set). The MIDI messages don't affect the panel controls including the Panel Voice selection since they are directly sent to the tone generator of the PSR-550. However, the following MIDI messages affects the panel controls such as Panel Voice, Style, Multi Pad and Song settings:
- MIDI MASTER TUNE, MASTER TUNE (XG System Parameter).
 - TRANSPOSE (XG System Parameter).
 - System Exclusive Messages related to the REVERB, CHORUS and DSP EFFECT settings.

Also, the MIDI messages affect the panel settings when one of the following MIDI reception modes is selected. These modes can be selected on the panel (see page 115).

Keyboard : The Note On/Off messages received at the designated Keyboard (receive) channel are processed the same as the notes normally played on the keyboard. In this mode, only the following channel messages will be recognized:

- Note On/Off
- Control Changes
 - Bank Select (R1 voice only)
 - Modulation
 - Volume(R1 voice only)
 - Data entry
 - Pan (R1 voice only)
 - Expression
 - Sustain
 - Sostenuto
 - Soft Pedal
 - Harmonic Content
 - Release time
 - Brightness
 - Reverb send level (R1 voice only)
 - Chorus send level (R1 voice only)
 - Variation send level (R1 voice only)
 - RPN(Pitch bend sensitivity)
 - All Notes Off
- Program Change (R1 voice only)
- Pitch Bend

Root : The note on/off messages received at the channel(s) set to "Root" are recognized as the bass notes in the accompaniment section. The bass notes will be detected regardless of the accompaniment on/off the PSR-550. However, the following MIDI messages affects and split point settings on the PSR-550 panel.

Chord : The note on/off messages received at the channel(s) set to "Chord" are recognized as the fingerings in the accompaniment section. The chords to be detected depend on the fingering mode on the PSR-550. The chords will be detected regardless of the accompaniment on/off and split point settings on the PSR-550 panel.

Off : The MIDI channel messages will not be received at the designated channel.

A

AC adaptor	12
Accompaniment	32
Accompaniment style	32
Accompaniment track	37
Accompaniment volume	37
ACMP	33
Assignable	122
Auto Accompaniment	32
Auto Accompaniment on/off	25, 33
Auto Accompaniment section	33, 34
Auto Fill	34

B

BACK	17
Backlight	122
Backup	136
Bank	44, 56
BASS	37, 96
Bass Hold	121
Batteries	12
Beat indicator	16
Break	121

C

Chord	16, 33, 38
Chord Fingerings	38
Chord Match	43, 94
CHORD1	37, 96
CHORD2	37, 96
Chorus	48
Clear	91, 95, 104
Clock	116
Control Change	107
Copy	64

D

Data dial	20
DC IN 10-12V jack	12
Default	20
Delete	21, 67
Demo song	13
Digital effect	46, 132
Direct Access	21, 24
DISK IN USE	58
Disk drive	58
Disk mode	25
Display	16
DOC	9, 68, 109
Drum Cancel	99
Drum Kit	31
Drum Kit List	128
DSP	49

E

Easy Navigator	16, 18
Echo	51, 134
Edit	86, 88, 91, 94, 102
Ending	34
ESEQ	109
EXIT	17
External	116

F

FAST	16, 46, 49
Fingered1	38, 39
Fingered2	38, 40
Fingering	17, 38
Floppy disk	58
Footswitch	10, 121
Format	60
Freeze	55
Full Keyboard	38, 40
Function	17, 106, 118
Function tree	22

G

GM (General MIDI)	9, 68, 109
-------------------------	------------

H

Harmony	16, 50
Harmony Volume	52
Harmony/Echo Type List	134
Headphone	10
HOST SELECT	110, 111

I

Included Data Disk	59
Initial send	117
Initialization	136
Insertion effect	50, 132
Internal	116
Intro	34

K

Keyboard	29
Keyboard Percussion	31

L

Left	29
Load	62
Local Control	116
Loop recording	97
Lower	112

- M**
- Main 34
 - Master Tuning 119
 - Master Volume 15
 - Maximum Polyphony 123
 - Measure 16, 71, 84
 - Menu 16, 17
 - Metronome 118
 - MIDI 106
 - MIDI Data Format 139
 - MIDI Implementation Chart 151
 - MIDI terminals 107
 - Mixer 17, 74, 76
 - Mode 25
 - Multi Finger 38, 40
 - Multi Pad 43, 92
 - Multi Track Recording 78, 79, 82
 - Music Database 14
 - Music Database List 131
 - Music stand 9
- N**
- Name 21, 56, 65, 90, 94, 104
 - NEXT 17
 - Note on/off 106
 - Number buttons 20
- O**
- Octave 74, 77, 88, 119
 - One Touch Setting 42
 - Overddub 97
- P**
- Packing List 4
 - Pan 74, 77, 88
 - Panel voice 123
 - PART ON/OFF 27, 28, 29
 - Pitch Bend 30
 - Pitch Bend Range 122
 - Polarity 121
 - Program Change 107
 - Punch In/Out 84
- Q**
- Quantize 86, 102
 - Quick Recording 78, 79, 80
- R**
- Receive 115
 - Record 17, 78, 92, 96
 - Record mode 25
 - Regist + 121
 - Regist - 121
 - Registration Memory 54
 - Rehearsal mode 25
 - Repeat 45, 69, 72
 - Return Level 47, 48, 49
 - Reverb 46
 - RHYTHM MAIN 37, 96
 - RHYTHM SUB 37, 96
 - Right 29
 - Ritardando 35
 - Root 115
- S**
- Save 60
 - Scale Tuning 119
 - Section 34
 - Send Level 47, 48, 49
 - Setting up 12
 - Shift 21
 - Single Finger 38
 - SLOW 16, 46, 49
 - Soft 121
 - Song Copy 64
 - Song Menu 72
 - Song mode 25
 - Song Play mode 69
 - Song volume 70
 - Sostenuto 121
 - Specification 156
 - Split Point 29, 40, 120
 - Standard MIDI 109
 - STANDBY switch 15
 - Start Measure 71
 - START/STOP 25, 32, 69, 81, 83, 93, 99
 - Style 32, 96
 - Style File 9, 57, 109
 - Style List 130
 - Style mode 25
 - Sustain 16, 121
 - SYNC START 25, 33
 - SYNC STOP 41
 - Synchro Start 25, 33
 - Synchro Stop 41, 121
 - Synchronized Start standby 25
 - System effect 50, 132

T

Tap	36, 121
Tempo	36
Time signature	80
TO HOST	107
TOUCH	16, 120
Touch Sensitivity	120
Track	37, 70, 82
Transmit	114
Transpose	16, 30, 73
Tremolo	51, 134
Trill	51, 134
Troubleshooting	135

U

Upper	112
Upper Octave	119
User Pad	92
User Song	78
User Style	96
Utility	17, 60, 64, 67, 118

V

Velocity	106
Voice	26
Voice Change	17, 74, 75
Voice L	28, 29
Voice List	123
Voice R1	26, 27, 29
Voice R2	27, 29
Voice Set	120
Volume	26, 37, 70, 74, 88, 89

W

Write-protect tab	58
-------------------------	----

X

XG	9, 68, 109
XG/GM	115

Specifications

Keyboards

- 61 standard-size keys (C1 — C6) with touch response.

Display

- Large multi-function LCD display

Setup

- STANDBY/ON
- Master Volume : MIN — MAX

Demo

- 9 Songs

Realtime Controls

- Pitch Bend wheel

Control & Number Buttons

- SONG
- STYLE
- MUSIC DATABASE
- VOICE L
- VOICE R1
- VOICE R2
- VOICE CHANGE
- MIXER
- NEXT/BACK
- DIRECT ACCESS
- EXIT
- Data dial, [1] — [0], [+ / YES], [- / NO]

Overall Controls

- Tempo : 32 — 280
- Transpose

Voice

- 219 Panel Voices +14 Drum Kits + 480 XG Voices
- Polyphony : 32
- Voice Set
- R1/R2/L Voices
- Part on/off (R1/R2/L)
- Voice Change : Voice number
- Mixer : Volume, Octave, Pan, Reverb Depth, Chorus Depth, DSP Depth

Auto Accompaniment

- 112 Styles
- Accompaniment Track : RHYTHM SUB/MAIN, BASS, CHORD 1/2, PAD, PHRASE1/2
- Accompaniment Track Settings : ON/OFF
- Accompaniment Control : ACMP ON/OFF, SYNC START, SYNC STOP, START/STOP, INTRO, MAIN A/B (AUTO FILL), ENDING/rit
- Beat Indicator
- Accompaniment Volume
- Voice Change : Voice number
- Mixer : Volume, Pan, Reverb depth, Chorus depth, DSP depth
- One Touch Setting
- Fingering Mode : Multi Finger/Single Finger/Fingered 1/Fingered 2/Full Keyboard

Music Database

- 220

Multi Pads

- 40 Multi Pad Banks
- 4 Pads + STOP
- Chord Match
- Naming

Digital Effects

- Reverb : 24 types
- Chorus : 16 types
- DSP (system/insertion) : 74 types
- Harmony/Echo : 22 types

Registration Memory

- 32 Registration Banks : 1 — 4
- Naming
- Accompaniment Freeze

Disk Operations

- Song playback/recording
- Load (Style/Multi Pad/Registration Memory)
- Save (Style/Multi Pad/Registration Memory)
- Utility : Format, Song Copy, Delete File

Song

- Song Volume
- Song Track Settings : ON/OFF
- Repeat Play
- Song Transpose

Song Recording

- Quick Record, Multi Record
- Recording Tracks : 1 — 16
- Punch In/Punch Out
- Quantize
- Naming
- Clear
- Setup Data : Volume, Octave, Pan, Reverb depth, Chorus depth, DSP depth

Multi Pad Recording

- User Pad Bank : 4 (41 — 44)
- Naming
- Clear
- Chord Match

Style Recording

- User Styles : 3 (113 — 115)
- Recording Tracks : 6 Sections x 8 tracks
- Drum Cancel
- Quantize
- Naming
- Clear

MIDI

- Transmit settings
- Receive settings
- Local Control
- Clock
- Initial Data Send
- MIDI template

Other functions

- Metronome
- Upper Octave
- Master Tuning
- Scale Tuning
- Split Point
- Touch Sensitivity
- Voice Set
- Footswitch function
- Pitch Bend Range

Auxiliary Jacks

- DC IN 10-12V, PHONES/OUTPUT, SUSTAIN, MIDI IN/OUT, TO HOST

Amplifiers

- 6W + 6W (when using PA-6 power adaptor)
- 4.5W + 4.5W (when using batteries)

Speakers

- 12 cm (4-3/4") x 2, 3 cm (1-3/16") x 2

Power Consumption

- 22W (when using PA-6 power adaptor)

Power Supply

- Adaptor : Yamaha PA-6 AC power adaptor
Rated Voltage DC 10-12V
Rated Current 2A
- Batteries : Six "D" size, R20P (LR20) or equivalent batteries

Dimensions (W x D x H)

- 952 x 387 x 169 (mm)
(37-1/2" x 15-1/4" x 6-5/8")

Weight

- 8.7 Kg (19.2 lbs.) excluding batteries

Supplied Accessories

- Data Disk
- Music Stand
- Owner's Manual

Optional Accessories

- Headphones : HPE-150
- AC Power Adaptor : PA-6
- Foot Switch : FC4, FC5
- Keyboard Stand : L-6, L-7

* Specifications and descriptions in this owner's manual are for information purposes only. Yamaha Corp. reserves the right to change or modify products or specifications at any time without prior notice. Since specifications, equipment or options may not be the same in every locale, please check with your Yamaha dealer.

FCC INFORMATION (U.S.A.)

1. IMPORTANT NOTICE: DO NOT MODIFY THIS UNIT!

This product, when installed as indicated in the instructions contained in this manual, meets FCC requirements. Modifications not expressly approved by Yamaha may void your authority, granted by the FCC, to use the product.

2. IMPORTANT: When connecting this product to accessories and/or another product use only high quality shielded cables. Cable/s supplied with this product MUST be used. Follow all installation instructions. Failure to follow instructions could void your FCC authorization to use this product in the USA.

3. NOTE: This product has been tested and found to comply with the requirements listed in FCC Regulations, Part 15 for Class "B" digital devices. Compliance with these requirements provides a reasonable level of assurance that your use of this product in a residential environment will not result in harmful interference with other electronic devices. This equipment generates/uses radio frequencies and, if not installed and used according to the instructions found in the users manual, may cause interference harmful to the operation of other electronic devices. Compliance with FCC

regulations does not guarantee that interference will not occur in all installations. If this product is found to be the source of interference, which can be determined by turning the unit "OFF" and "ON", please try to eliminate the problem by using one of the following measures:

Relocate either this product or the device that is being affected by the interference.

Utilize power outlets that are on different branch (circuit breaker or fuse) circuits or install AC line filter/s.

In the case of radio or TV interference, relocate/reorient the antenna. If the antenna lead-in is 300 ohm ribbon lead, change the lead-in to co-axial type cable.

If these corrective measures do not produce satisfactory results, please contact the local retailer authorized to distribute this type of product. If you can not locate the appropriate retailer, please contact Yamaha Corporation of America, Electronic Service Division, 6600 Orangethorpe Ave, Buena Park, CA90620

The above statements apply ONLY to those products distributed by Yamaha Corporation of America or its subsidiaries.

* This applies only to products distributed by YAMAHA CORPORATION OF AMERICA.

(class B)

Entsorgung leerer Batterien (nur innerhalb Deutschlands)

Leisten Sie einen Beitrag zum Umweltschutz. Verbrauchte Batterien oder Akkumulatoren dürfen nicht in den Hausmüll. Sie können bei einer Sammelstelle für Altbatterien bzw. Sondermüll abgegeben werden. Informieren Sie sich bei Ihrer Kommune.

(battery)

OBSERVERA!

Apparaten kopplas inte ur växelströmskällan (nätet) så länge som den är ansluten till vägguttaget, även om själva apparaten har stängts av.

ADVARSEL: Netspændingen til dette apparat er IKKE afbrudt, så længe netledningen sidder i en stikkontakt, som er tændt — også selvom der er slukket på apparatets afbryder.

VAROITUS: Laitteen toisiopiiriin kytketty käyttökytin ei irroita koko laitetta verkosta.

(standby)

Limited Warranty

90 DAYS LABOR

1 YEAR PARTS

Yamaha Corporation of America, hereafter referred to as Yamaha, warrants to the original consumer of a product included in the categories listed below, that the product will be free of defects in materials and/or workmanship for the periods indicated. This warranty is applicable to all models included in the following series of products:

PSR SERIES OF PORTATONE ELECTRONIC KEYBOARDS

If during the first 90 days that immediately follows the purchase date, your new Yamaha product covered by this warranty is found to have a defect in material and/or workmanship, Yamaha and/or its authorized representative will repair such defect without charge for parts or labor.

If parts should be required after this 90 day period but within the one year period that immediately follows the purchase date, Yamaha will, subject to the terms of this warranty, supply these parts without charge. However, charges for labor, and/or any miscellaneous expenses incurred are the consumers responsibility. Yamaha reserves the right to utilize reconditioned parts in repairing these products and/or to use reconditioned units as warranty replacements.

THIS WARRANTY IS THE ONLY EXPRESS WARRANTY WHICH YAMAHA MAKES IN CONNECTION WITH THESE PRODUCTS. ANY IMPLIED WARRANTY APPLICABLE TO THE PRODUCT, INCLUDING THE WARRANTY OF MERCHANT ABILITY IS LIMITED TO THE DURATION OF THE EXPRESS WARRANTY. YAMAHA EXCLUDES AND SHALL NOT BE LIABLE IN ANY EVENT FOR INCIDENTAL OR CONSEQUENTIAL DAMAGES.

Some states do not allow limitations that relate to implied warranties and/or the exclusion of incidental or consequential damages. Therefore, these limitations and exclusions may not apply to you.

This warranty gives you specific legal rights. You may also have other rights which vary from state to state.

CONSUMERS RESPONSIBILITIES

If warranty service should be required, it is necessary that the consumer assume certain responsibilities:

1. Contact the Customer Service Department of the retailer selling the product, or any retail outlet authorized by Yamaha to sell the product for assistance. You may also contact Yamaha directly at the address provided below.
2. Deliver the unit to be serviced under warranty to: the retailer selling the product, an authorized service center, or to Yamaha with an explanation of the problem. Please be prepared to provide proof purchase date (sales receipt, credit card copy, etc.) when requesting service and/or parts under warranty.
3. Shipping and/or insurance costs are the consumers responsibility.* Units shipped for service should be packed securely.

*Repaired units will be returned PREPAID if warranty service is required within the first 90 days.

IMPORTANT: Do NOT ship anything to ANY location without prior authorization. A Return Authorization (RA) will be issued that has a tracking number assigned that will expedite the servicing of your unit and provide a tracking system if needed.

4. Your owners manual contains important safety and operating instructions. It is your responsibility to be aware of the contents of this manual and to follow all safety precautions.

EXCLUSIONS

This warranty does not apply to units whose trade name, trademark, and/or ID numbers have been altered, defaced, exchanged removed, or to failures and/or damages that may occur as a result of:

1. Neglect, abuse, abnormal strain, modification or exposure to extremes in temperature or humidity.
2. Improper repair or maintenance by any person who is not a service representative of a retail outlet authorized by Yamaha to sell the product, an authorized service center, or an authorized service representative of Yamaha.
3. This warranty is applicable only to units sold by retailers authorized by Yamaha to sell these products in the U.S.A., the District of Columbia, and Puerto Rico. This warranty is not applicable in other possessions or territories of the U.S.A. or in any other country.

Please record the model and serial number of the product you have purchased in the spaces provided below.

Model _____ Serial # _____ Sales Slip # _____

Purchased from _____ Date _____
(Retailer)

YAMAHA CORPORATION OF AMERICA
Electronic Service Division
6600 Orangethorpe Avenue
Buena Park, CA 90620

KEEP THIS DOCUMENT FOR YOUR RECORDS. DO NOT MAIL!

For details of products, please contact your nearest Yamaha or the authorized distributor listed below.

Pour plus de détails sur les produits, veuillez-vous adresser à Yamaha ou au distributeur le plus proche de vous figurant dans la liste suivante.

Die Einzelheiten zu Produkten sind bei Ihrer unten aufgeführten Niederlassung und bei Yamaha Vertragshändlern in den jeweiligen Bestimmungsländern erhältlich.

Para detalles sobre productos, contacte su tienda Yamaha más cercana o el distribuidor autorizado que se lista debajo.

NORTH AMERICA

CANADA

Yamaha Canada Music Ltd.
135 Milner Avenue, Scarborough, Ontario,
M1S 3R1, Canada
Tel: 416-298-1311

U.S.A.

Yamaha Corporation of America
6600 Orangethorpe Ave., Buena Park, Calif. 90620,
U.S.A.
Tel: 714-522-9011

CENTRAL & SOUTH AMERICA

MEXICO

**Yamaha de Mexico S.A. De C.V.,
Departamento de ventas**
Javier Rojo Gomez No.1149, Col. Gpe Del
Moral, Deleg. Iztapalapa, 09300 Mexico, D.F.
Tel: 686-00-33

BRAZIL

Yamaha Musical do Brasil LTDA.
Av. Rebouças 2636, São Paulo, Brasil
Tel: 011-853-1377

ARGENTINA

Yamaha Music Argentina S.A.
Viamonte 1145 Piso2-B 1053,
Buenos Aires, Argentina
Tel: 1-4371-7021

PANAMA AND OTHER LATIN AMERICAN COUNTRIES/ CARIBBEAN COUNTRIES

Yamaha de Panama S.A.
Torre Banco General, Piso 7, Urbanización Marbella,
Calle 47 y Aquilino de la Guardia,
Ciudad de Panamá, Panamá
Tel: 507-269-5311

EUROPE

THE UNITED KINGDOM

Yamaha-Kemble Music (U.K.) Ltd.
Sherbourne Drive, Tilbrook, Milton Keynes,
MK7 8BL, England
Tel: 01908-366700

IRELAND

Danfay Ltd.
61D, Sallynoggin Road, Dun Laoghaire, Co. Dublin
Tel: 01-2859177

GERMANY/SWITZERLAND

Yamaha Europa GmbH.
Siemensstraße 22-34, 25462 Rellingen,
F.R. of Germany
Tel: 04101-3030

AUSTRIA

Yamaha Music Austria
Schleiergasse 20, A-1100 Wien Austria
Tel: 01-60203900

THE NETHERLANDS

Yamaha Music Nederland
Kanaalweg 18G, 3526KL, Utrecht, The Netherlands
Tel: 030-2828411

BELGIUM

Yamaha Music Belgium
Keiberg Imperiastraat 8, 1930 Zaventem, Belgium
Tel: 02-7258220

FRANCE

**Yamaha Musique France,
Division Claviers**
BP 70-77312 Marne-la-Vallée Cedex 2, France
Tel: 01-64-61-4000

ITALY

**Yamaha Musica Italia S.P.A.,
Home Keyboard Division**
Viale Italia 88, 20020 Lainate (Milano), Italy
Tel: 02-935-771

SPAIN/PORTUGAL

Yamaha-Hazen Electronica Musical, S.A.
Ctra. de la Coruna km. 17, 200, 28230
Las Rozas (Madrid) Spain
Tel: 91-201-0700

GREECE

Philippe Nakas S.A.
Navarinou Street 13, P.Code 10680, Athens, Greece
Tel: 01-364-7111

SWEDEN

Yamaha Scandinavia AB
J. A. Wettergrens Gata 1
Box 30053
S-400 43 Göteborg, Sweden
Tel: 031 89 34 00

DENMARK

YS Copenhagen Liaison Office
Generatorvej 8B
DK-2730 Herlev, Denmark
Tel: 44 92 49 00

FINLAND

F-Musiikki Oy
Kluuvikatu 6, P.O. Box 260,
SF-00101 Helsinki, Finland
Tel: 09 618511

NORWAY

Norsk filial av Yamaha Scandinavia AB
Grini Næringspark 1
N-1345 Østerås, Norway
Tel: 67 16 77 70

ICELAND

Skeifan HF
Skeifan 17 P.O. Box 8120
IS-128 Reykjavik, Iceland
Tel: 525 5000

OTHER EUROPEAN COUNTRIES

Yamaha Europa GmbH.
Siemensstraße 22-34, 25462 Rellingen,
F.R. of Germany
Tel: 04101-3030

AFRICA

**Yamaha Corporation,
Asia-Pacific Music Marketing Group**
Nakazawa-cho 10-1, Hamamatsu, Japan 430-8650
Tel: 053-460-2312

MIDDLE EAST

TURKEY/CYPRUS

Yamaha Europa GmbH.
Siemensstraße 22-34, 25462 Rellingen,
F.R. of Germany
Tel: 04101-3030

OTHER COUNTRIES

Yamaha Music Gulf FZE
LB21-128 Jebel Ali Freezone
P.O.Box 17328, Dubai, U.A.E.
Tel: 971-4-881-5868

ASIA

HONG KONG

Tom Lee Music Co., Ltd.
11/F., Silvercord Tower 1, 30 Canton Road,
Tsimshatsui, Kowloon, Hong Kong
Tel: 2737-7688

INDONESIA

**PT. Yamaha Music Indonesia (Distributor)
PT. Nusantara**
Gedung Yamaha Music Center, Jalan Jend. Gatot
Subroto Kav. 4, Jakarta 12930, Indonesia
Tel: 21-520-2577

KOREA

Cosmos Corporation
1461-9, Seocho Dong, Seocho Gu, Seoul, Korea
Tel: 02-3486-0011

MALAYSIA

Yamaha Music Malaysia, Sdn., Bhd.
Lot 8, Jalan Perbandaran, 47301 Kelana Jaya,
Petaling Jaya, Selangor, Malaysia
Tel: 3-703-0900

PHILIPPINES

Yupango Music Corporation
339 Gil J. Puyat Avenue, P.O. Box 885 MCPO,
Makati, Metro Manila, Philippines
Tel: 819-7551

SINGAPORE

Yamaha Music Asia Pte., Ltd.
11 Ubi Road #06-00, Meiban Industrial Building,
Singapore
Tel: 65-747-4374

TAIWAN

Yamaha KHS Music Co., Ltd.
10F, 150, Tun-Hwa Northroad,
Taipei, Taiwan, R.O.C.
Tel: 02-2713-8999

THAILAND

Siam Music Yamaha Co., Ltd.
121/60-61 RS Tower 17th Floor,
Ratchadaphisek RD., Dindaeng,
Bangkok 10320, Thailand
Tel: 02-641-2951

THE PEOPLE'S REPUBLIC OF CHINA AND OTHER ASIAN COUNTRIES

**Yamaha Corporation,
Asia-Pacific Music Marketing Group**
Nakazawa-cho 10-1, Hamamatsu, Japan 430-8650
Tel: 053-460-2317

OCEANIA

AUSTRALIA

Yamaha Music Australia Pty. Ltd.
Level 1, 99 Queensbridge Street, Southbank, Victoria
3006, Australia
Tel: 3-9693-5111

NEW ZEALAND

Music Houses of N.Z. Ltd.
146/148 Captain Springs Road, Te Papapa,
Auckland, New Zealand
Tel: 9-634-0099

COUNTRIES AND TRUST TERRITORIES IN PACIFIC OCEAN

**Yamaha Corporation,
Asia-Pacific Music Marketing Group**
Nakazawa-cho 10-1, Hamamatsu, Japan 430-8650
Tel: 053-460-2312

HEAD OFFICE Yamaha Corporation, Pro Audio & Digital Musical Instrument Division
Nakazawa-cho 10-1, Hamamatsu, Japan 430-8650
Tel: 053-460-3273



Yamaha PK CLUB (Portable Keyboard Home Page, English only)

<http://www.yamaha.co.jp/english/product/pk>

Yamaha Manual Library (English versions only)

<http://www2.yamaha.co.jp/manual/english/>