



AB





DESKTOP AUDIO SYSTEM

TSX-80

OWNER'S MANUAL

CAUTION: READ THIS BEFORE OPERATING YOUR UNIT.

- 1 To assure the finest performance, please read this manual carefully. Keep it in a safe place for future reference.
- 2 Install this unit in a well ventilated, cool, dry, clean place - away from direct sunlight, heat sources, vibration, dust, moisture and cold. For proper ventilation, allow the following minimum clearances.
Top: 15 cm (6 in)
Rear: 10 cm (4 in)
Sides: 10 cm (4 in)
- 3 Locate this unit away from other electrical appliances, motors, or transformers to avoid humming sounds.
- 4 Do not expose this unit to sudden temperature changes from cold to hot, and do not locate this unit in an environment with high humidity (i.e. a room with a humidifier) to prevent condensation inside this unit, which may cause an electrical shock, fire, damage to this unit, and/or personal injury.
- 5 Avoid installing this unit where foreign object may fall onto this unit and/or this unit may be exposed to liquid dripping or splashing. On the top of this unit, do not place:
 - Other components, as they may cause damage and/or discoloration on the surface of this unit.
 - Burning objects (i.e. candles), as they may cause fire, damage to this unit, and/or personal injury.
 - Containers with liquid in them, as they may fall and liquid may cause electrical shock to the user and/or damage to this unit.
- 6 Do not cover this unit with a newspaper, tablecloth, curtain, etc. in order not to obstruct heat radiation. If the temperature inside this unit rises, it may cause fire, damage to this unit, and/or personal injury.
- 7 Do not plug in this unit to a wall outlet until all connections are complete.
- 8 Do not operate this unit upside-down. It may overheat, possibly causing damage.
- 9 Do not use force on switches, knobs and/or cords.
- 10 When disconnecting the power cable from the wall outlet, grasp the plug; do not pull the cable.
- 11 Do not clean this unit with chemical solvents; this might damage the finish. Use a clean, dry cloth.
- 12 Only voltage specified on this unit must be used. Using this unit with a higher voltage than specified is dangerous and may cause fire, damage to this unit, and/or personal injury. Yamaha will not be held responsible for any damage resulting from use of this unit with a voltage other than specified.
- 13 To prevent damage by lightning, keep the power cable disconnected from a wall outlet or this unit during a lightning storm.
- 14 Do not attempt to modify or fix this unit. Contact qualified Yamaha service personnel when any service is needed. The cabinet should never be opened for any reasons.
- 15 When not planning to use this unit for long periods of time (i.e. vacation), disconnect the AC power plug from the wall outlet.
- 16 Be sure to read the “TROUBLESHOOTING” section on common operating errors before concluding that this unit is faulty.
- 17 Before moving this unit, press  to set the system to off, and disconnect the AC power plug from the wall outlet.
- 18 Condensation will form when the surrounding temperature changes suddenly. Disconnect the power cable from the outlet, then leave this unit alone.
- 19 When using this unit for a long time, this unit may become warm. Turn the system off, then leave this unit alone for cooling.
- 20 Install this unit near the wall outlet and where the AC power plug can be reached easily.
- 21 The batteries shall not be exposed to excessive heat such as sunshine, fire or the like. When you dispose of batteries, follow your regional regulations.
- 22 Be sure to use the AC adaptor supplied with this unit. Using an AC adaptor other than the one provided may cause fire or damage to this unit.

This unit is not disconnected from the AC power source as long as it is connected to the wall outlet, even if this unit itself is turned off by . In this state, this unit is designed to consume a very small quantity of power.

WARNING

TO REDUCE THE RISK OF FIRE OR ELECTRIC SHOCK, DO NOT EXPOSE THIS UNIT TO RAIN OR MOISTURE.

CAUTION

Danger of explosion if battery is incorrectly replaced. Replace only with the same or equivalent type.

There is a chance that placing this unit too close to a CRT-based (Braun tube) TV set might impair picture color. Should this happen, move this unit away from the TV set.

CONTENTS

NAMES OF PARTS AND THEIR FUNCTIONS	2	LISTENING TO DAB STATIONS	7
BASIC FUNCTIONS.....	4	LISTENING TO FM STATIONS	9
LISTENING TO iPod™ AND EXTERNAL SOURCES.....	6	TROUBLESHOOTING.....	10
		SPECIFICATIONS.....	12

■ Features

- Hi-quality iPod/iPhone, radio (DAB/FM) and external device playability.
- Firm bass sound and spacious stereo sound from 2.1 ch speaker system (tweeter × 2, woofer × 1), SR-Bass™ (Yamaha Swing Radiator Bass technology) and DSP in a compact unit.
- Easy user-intuitive interface by buttons with Guide LED and knob dials.

■ About this manual

- This unit is iPod and also iPhone-compatible. “iPod” described in this manual may also refer to “iPhone”.
- This manual describes how to operate this unit using buttons on the unit. Some of these operations are also available using the remote control.

■ Supplied accessories

Remote control

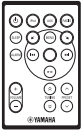

AC adaptor

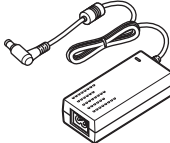

(DC 15 V, 2.66 A,
model number:
NU40-2150266-I3)

Power cable

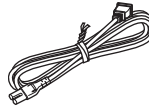

Dock cover



■ Using the remote control

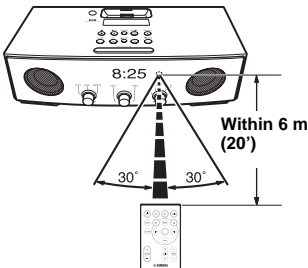

■ Replacing the battery in the remote control

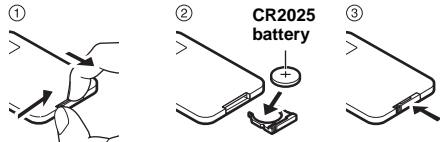

NAMES OF PARTS AND THEIR FUNCTIONS

■ Front and top panel

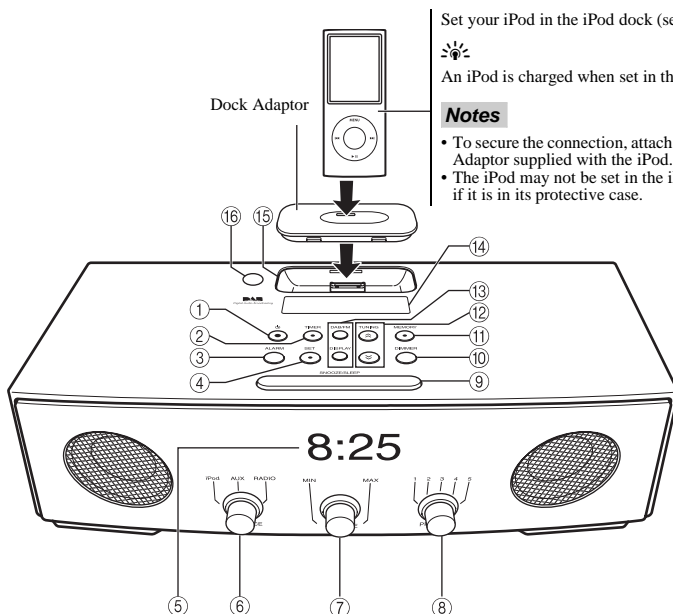

Set your iPod in the iPod dock (see 15 below).



An iPod is charged when set in the iPod dock.

Notes

- To secure the connection, attach a compatible Dock Adaptor supplied with the iPod.
- The iPod may not be set in the iPod dock securely if it is in its protective case.

- ① **Power**: Press to turn the system on/off.
Time is displayed even when the system is off.
- Press and hold **Power** on the top of the unit for more than 3 seconds to set the system to standby mode. All the information on the front panel display is not displayed in standby mode. This can reduce power consumption. To cancel standby mode, press **Power**.
- Even in system off/standby mode, the alarm function is available.
- ② **TIMER**: Timer setting (☞ P. 5)
- ③ **ALARM**: Alarm on/off (☞ P. 4)
- ④ **SET**: Alarm setting (☞ P. 4)
- ⑤ **Front panel display**
- ⑥ **SOURCE**: iPod, AUX, RADIO
- ⑦ **VOLUME**: Volume control
- ⑧ **PRESET**: Storing your favorite 5 DAB and 5 FM radio stations (☞ P. 8, P. 9)
- ⑨ **SNOOZE/SLEEP** (☞ P. 5)
- ⑩ **DIMMER**: Setting brightness of the front panel
A (auto) → 3 (brightest) → 2 → 1 (darkest) → back to A
- When A (auto) is set, the brightness of the front panel is adjusted automatically depending on the brightness of the room.
- ⑪ **MEMORY** (☞ P. 7, P. 8, P. 9)
- ⑫ **TUNING** (☞ P. 7, P. 9)
- ⑬ **DAB/FM**: Switching DAB/FM (☞ P. 7, P. 9)
DISPLAY: Switching the DAB information display (☞ P. 8)
- ⑭ **DAB information display**: Displaying DAB information
- ⑮ **iPod dock**: Set an iPod.
 Cover the iPod dock with the dock cover when not using.
- ⑯ **Illumination sensor**: Measuring surrounding illuminance. Do not cover this sensor.

■ Rear panel

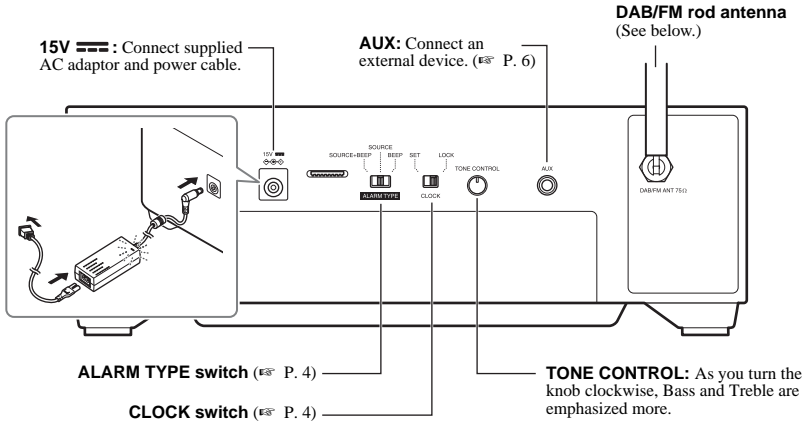

■ Extending rod antenna

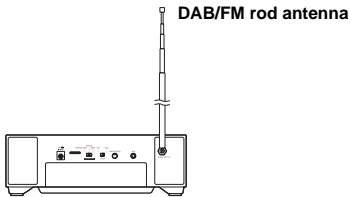

Notes

- When you listen to DAB/FM, extend the antenna.
- If DAB/FM reception is poor, change the height or direction of the antenna, or relocate the unit.

■ Remote control

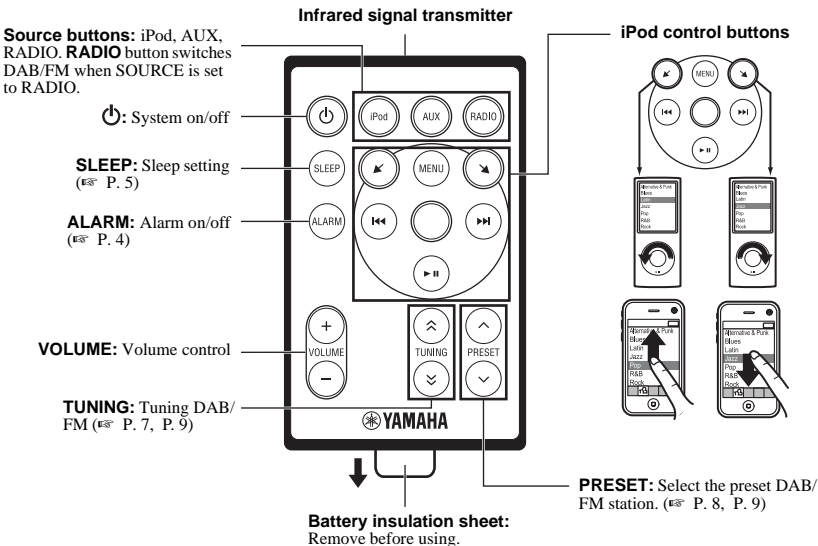

BASIC FUNCTIONS

Adjusting the clock

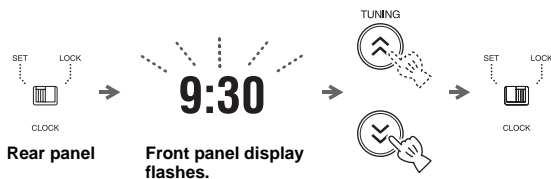

- 1 Set **CLOCK** to **SET**.
- 2 Set the time with **TUNING**.
- 3 Set **CLOCK** to **LOCK**.

Note

The time settings are lost approximately one week after unplugging the unit.

Alarm setting

This unit can play back iPod/radio (DAB/FM) and/or beep sound at the set time.

■ Setting the alarm time and sound

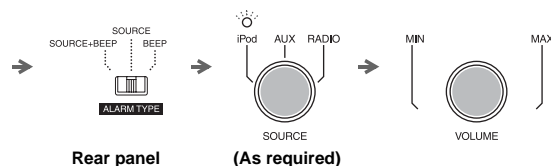
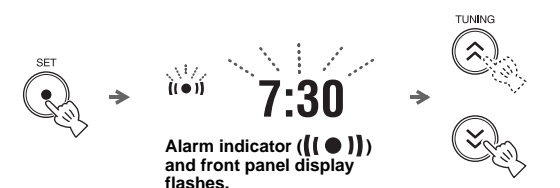

- 1 Press **SET**.
- 2 Set the alarm time with **TUNING**.
- 3 Set **ALARM TYPE**.

- **SOURCE+BEEP**: selected source (played back from 3 minutes before the alarm time) and beep sound (played back at the alarm time)
- **SOURCE**: selected source
- **BEEP**: beep sound only

When you select **SOURCE+BEEP** or **SOURCE**, select:

- **iPod**: this unit resumes the song you listened to last time.
- **RADIO**: this unit plays back the DAB/FM station you listened to last time.

- 4 Set the alarm volume.
- 5 Press **SET**.

Alarm is set and the alarm indicator ((●)) lights up.

Note

When iPod is selected as a source, set the iPod in the iPod dock (P. 2). If iPod is not set at the alarm time, beep sound is played back.

■ Switching the alarm on/off



Switch on/off the alarm function.

When the alarm is on, the alarm indicator ((●)) lights up and alarm time is displayed for a while.

Operations during playing back alarm sound

At the set time, alarm sound plays back. During playback, operations below are available.

■ Using the snooze function



Press **SNOOZE/SLEEP**.

The alarm sound stops and resumes after 5 minutes.

■ Stopping the alarm

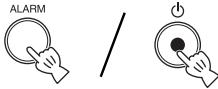

Press **ALARM** or **⏻**.



- Unless you stop the alarm, the alarm stops after 60 minutes automatically.
- When you stop the alarm, the alarm time setting, etc., is saved for convenient use next time.

Sleep setting

You can set the time to turn off the system automatically when sleep is set to on.



Press repeatedly.



Sleep indicator (**ZZ**) and front panel display flash.

Select the sleep time.

You can set 30, 60, 90 or 120 minutes.

When the sleep function is on, the sleep indicator (**ZZ**) lights up.



To cancel the sleep, press **SNOOZE/SLEEP**.

Timer setting

You can set the countdown timer.

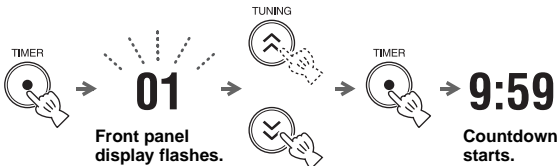

1 Press **TIMER**.

2 Set the countdown time with **TUNING**.

You can set the time,

- 1 to 15 minutes: minute steps.
- 20 to 120 minutes: 10-minute steps.

3 Press **TIMER**.

Countdown starts. When the timer reaches 0, the timer sound plays back.



- To stop the timer sound, press **TIMER**.
- To cancel the timer, press **TIMER** during countdown.

Note

Sleep and timer cannot be used together.

- Sleep cannot be set during countdown.
- Sleep is set to off when timer is set while sleep is on.

LISTENING TO iPod™ AND EXTERNAL SOURCES

Listening to your iPod™

For details on compatible iPod models, refer to “SPECIFICATIONS” (P. 12).

■ Playing back

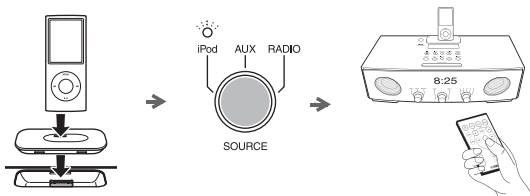

- 1 Set your iPod in the iPod dock.
- 2 Set **SOURCE** to iPod.
- 3 Play the iPod.

Playback operations are available with both the remote control and the iPod set in the iPod dock.



- You can remove the iPod whenever you want.
- When music/video in the iPod is played back, this unit turns the system on automatically and plays back the iPod even if the unit is system off.
- This unit turns the system off automatically after a while if the iPod is turned off or removed from the iPod dock when **SOURCE** is set to iPod.

Playing back external sources

■ Playing back

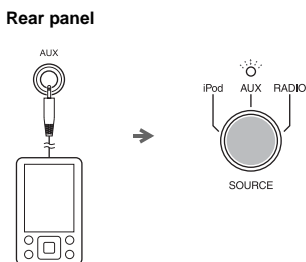

- 1 Connect your portable audio device to AUX using a commercially available 3.5 mm (1/8 in) mini plug cable.

Note

Turn down the volume of this unit and your portable audio device before connection.

- 2 Set **SOURCE** to AUX.
- 3 Start playback on the connected portable audio device.

LISTENING TO DAB STATIONS

DAB (Digital Audio Broadcasting) uses digital signals for clearer sound and more stable reception compared to analog signals.

DAB is broadcast in blocks of data called 'ensembles' containing up to several radio stations that are simultaneously broadcast.

DAB can also include an extensive amount of text information enabling you to select a station by name.

Other information, such as the name of song and artist or several kinds of news can be displayed on the DAB information display.

Preparing for DAB reception

Before tuning into DAB stations, an initial scan must be performed.

When you select the DAB for the first time, the initial scan is performed automatically.

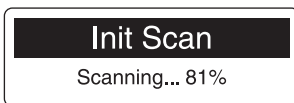
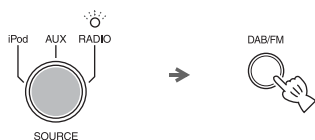

Top panel



Top panel

- 1 Set **SOURCE** to **RADIO**.
- 2 Select DAB with **DAB/FM**.
- 3 The initial scan starts.
During the scan, degree of progress is displayed on the DAB information display.
- 4 Scan is completed.
"Completed" and the number of receivable DAB stations appear on the DAB information display.

Notes

- To perform initial scan manually, press and hold **MEMORY** for 3 seconds and then press **MEMORY** when scan starting screen is displayed.
- If the initial scan is performed, stored DAB station information and preset DAB stations are cleared.

Tuning DAB stations

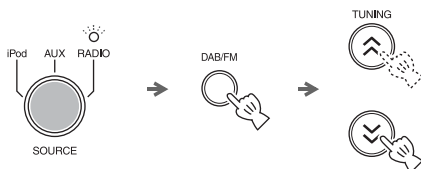

- 1 Set **SOURCE** to **RADIO**.
- 2 Select DAB with **DAB/FM**.
- 3 Select a DAB station with **TUNING**.

DAB station information

Basic information

While receiving DAB, switch the DAB information display.

When the unit does not receive a DAB signal, "Off Air" is displayed instead of the DAB station name.

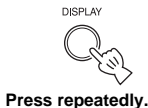

Select DAB information by pressing **DISPLAY** repeatedly. Information is displayed in order shown below.

Text information



Ensemble name (**E** is displayed before the ensemble name.)



Status 1 (channel label and frequency)



Status 2 (audio format and signal quality)



Back to the top.

Indicators on the DAB information display

Signal strength indicator:

shows current signal strength.

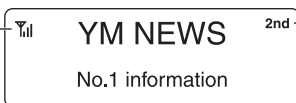

Secondary indicator:

Some stations have sub (secondary) stations. During listening a secondary station, the secondary indicator is displayed.

Presetting DAB stations

You can store your favorite 5 DAB stations with the preset function.

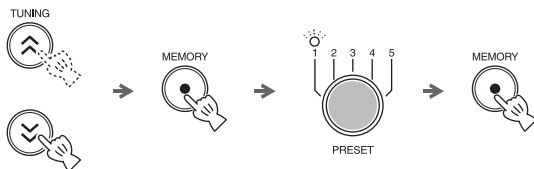

- 1 Tune into a favorite DAB station.
- 2 Press **MEMORY**.
- 3 Select the **PRESET** number you want to store to.



To cancel the preset, press **TUNING** again.

- 4 Press **MEMORY** to complete.

Selecting preset DAB stations

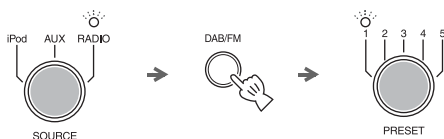

- 1 Set **SOURCE** to RADIO.
- 2 Select DAB with **DAB/FM**.
- 3 Select the preset DAB station with **PRESET**.

LISTENING TO FM STATIONS

Tuning FM stations

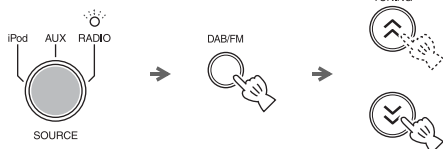

- 1 Set **SOURCE** to **RADIO**.
- 2 Select FM with **DAB/FM**.
- 3 For automatic tuning, press and hold **TUNING**.
For manual tuning, press **TUNING** repeatedly.

Note

If you tune to a station manually, the sound is monaural.

Presetting FM stations

You can store your favorite 5 FM stations with the preset function.

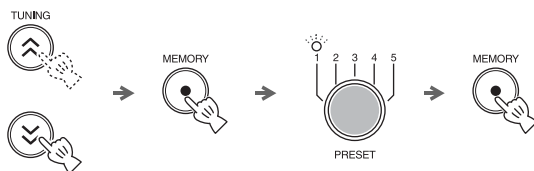

- 1 Tune into a favorite FM station.
- 2 Press **MEMORY**.
- 3 Select the **PRESET** number you want to store to.



To cancel the preset, press **TUNING** again.

- 4 Press **MEMORY** to complete.

Selecting preset FM stations

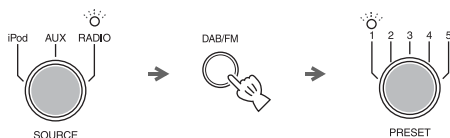

- 1 Set **SOURCE** to **RADIO**.
- 2 Select FM with **DAB/FM**.
- 3 Select the preset FM station with **PRESET**.

TROUBLESHOOTING

In case of a problem with the unit, check the following list first. If you cannot solve your problem with the suggested solutions or if your problem is not listed below, turn off and unplug the unit, and consult the nearest authorized Yamaha dealer or service center.

General

Problem	Cause	Solution
The speakers make no sound.	The volume may be set to the minimum level.	Adjust the volume level.
	The source may be incorrect.	Select the correct source.
Sound suddenly turns off.	The sleep (Ⓜ P. 5) may be set.	Turn on the system and play the source again.
Sound is cracked/distorted or there is abnormal noise.	Input source volume is excessive, or volume of this unit is excessive (especially Bass).	Adjust volume with VOLUME , or adjust Bass with TONE CONTROL .
The unit does not operate properly.	The unit may have received a strong electrical shock such as lightning or excessive static electricity, or power supply may have dropped.	Set the system to off, and disconnect the power cable. Wait about 30 seconds, reconnect the power cable, and turn on the system.
The system turns on but immediately shuts off.	The power cable may be connected improperly.	Make sure the power cable is plugged into the wall outlet firmly.
	The unit may have received a strong electrical shock such as lightning or excessive static electricity.	Set the system to off, and disconnect the power cable. Wait about 30 seconds, reconnect the power cable, and turn on the system.
A digital or high-frequency equipment produces noises.	The unit may be placed too close to the digital or high-frequency equipment.	Place the unit farther away from the equipment.
The clock setting has been cleared.	The unit is left more than one week after you disconnect the power cable from the wall outlet.	Plug the power cable into the wall outlet firmly, and set the clock again (Ⓜ P. 4).
iPod does not play back at the alarm time even if SOURCE is set to iPod.	The iPod is not set in the iPod dock.	Set the iPod in the iPod dock (Ⓜ P. 2).
	ALARM TYPE is set to BEEP.	Set ALARM TYPE to SOURCE+BEEP or SOURCE (Ⓜ P. 4).
Clock flashes and the unit cannot be operated.	CLOCK on the rear panel is set to SET, and this unit is in clock setting mode.	Set CLOCK to LOCK.

iPod™

Problem	Cause	Solution
No sound	The iPod is not set in the iPod dock firmly.	Set the iPod firmly.
	Earphones are connected.	Remove the earphones.
	The iPod software version has not been updated.	Download the latest iTunes software to update the iPod software version to the latest.
The iPod does not charge up.	The iPod is set in the iPod dock improperly.	Remove the iPod from the unit, and then set it in the iPod dock again (Ⓜ P. 2).

DAB reception

Problem	Cause	Solution
Cannot tune into any DAB stations.	The initial scan operations were not performed.	Perform the initial scan operations (☞ P. 7).
	There is no DAB coverage in your area.	Check with your dealer or WorldDMB Online at “ http://www.worlddab.org ” for a listing of the DAB coverage in your area.
	The DAB signals are too weak.	Change the height or direction of the antenna, or relocate the unit.
The initial scan operations are not successful and “Not found” appears on the DAB information display.	The DAB signals are too weak.	Change the height or direction of the antenna, or relocate the unit.
	There is no DAB coverage in your area.	Check with your dealer or WorldDMB Online at “ http://www.worlddab.org ” for a listing of the DAB coverage in your area.
The DAB station reception is weak.	The DAB signals are too weak.	Change the height or direction of the antenna, or relocate the unit.
There is noise interference (e.g. hiss, crackle or jitter).	The antenna needs to be repositioned.	Change the height or direction of the antenna, or relocate the unit.
	The DAB signals are too weak.	Change the height or direction of the antenna, or relocate the unit.
The DAB station information does not appear or is inaccurate.	The DAB station may be temporarily out of service, or the DAB station information is not provided by the DAB broadcaster.	Contact the DAB broadcaster.

FM reception

Problem	Cause	Solution
Too much noise during stereo broadcast.	The antenna needs to be repositioned.	Change the height or direction of the antenna, or relocate the unit.
	The FM station you selected may be far from your area, or the FM wave reception is weak in your area.	Try manual tuning to improve the signal quality (☞ P. 9).
FM wave reception is weak. (Sound is distorted.)	Multipath reflection or other radio interferences may have occurred.	Change the height or direction of the antenna, or relocate the unit.

Remote control

Problem	Cause	Solution
The remote control does not work properly.	The remote control may be operated outside its operation range.	For information on the remote control operation range, refer to “Using the remote control” (☞ P. 1).
	The remote control sensor on the unit may be exposed to direct sunlight or lighting (inverted fluorescent lamps).	Change the lighting or orientation of the unit.
	The battery may be worn out.	Replace the battery with a new one (☞ P. 1).
	There are obstacles between the sensor of the unit and the remote control.	Remove the obstacles.

SPECIFICATIONS

■ PLAYER SECTION

iPod

- Supported iPod iPod (5th generation), iPod classic, iPod nano, iPod touch
- Supported iPhone iPhone, iPhone 3G, iPhone 3GS

AUX IN

- Input connector STEREO L/R: 3.5 mm (1/8 in) STEREO mini jack

■ AMPLIFIER SECTION

- Maximum output power 4 W + 4 W + 8 W
(6 Ω 1 kHz, 10% THD)
- Driver unit 4 cm (1 5/8 in) full-range driver × 2
5.5 cm (2 1/8 in) woofer + SR-Bass × 1

■ TUNER SECTION

- Tuning range
FM 87.50 to 108.00 MHz
DAB 174 to 240 MHz (Band III)

■ GENERAL

- Power supply AC 100 to 240 V, 50/60 Hz
- Power consumption 10 W
- System off consumption 1.2 W
- Standby consumption 1.0 W or less
- Dimensions (W × H × D) 260 × 90 × 164 mm
(10 1/4 × 3 1/2 × 6 1/2 in)
(including DAB/FM rod antenna)
- Weight 1.2 kg (2.6 lbs.)

Specifications are subject to change without notice.

■ For U.K. customers

If the socket outlets in the home are not suitable for the plug supplied with this appliance, it should be cut off and an appropriate 3 pin plug fitted. For details, refer to the instructions described below.

Note

The plug severed from the mains lead must be destroyed, as a plug with bared flexible cord is hazardous if engaged in a live socket outlet.



Digital Audio Broadcasting
This unit supports DAB tuning.

iPod™, iPhone™

iPod is a trademark of Apple Inc., registered in the U.S. and other countries.
iPhone is a trademark of Apple Inc.

“Made for iPod” means that an electronic accessory has been designed to connect specifically to iPod and has been certified by the developer to meet Apple performance standards.

“Works with iPhone” means that an electronic accessory has been designed to connect specifically to iPhone and has been certified by the developer to meet Apple performance standards.

Apple is not responsible for the operation of this device or its compliance with safety and regulatory standards.

■ Special Instructions for U.K. Model

IMPORTANT

THE WIRES IN MAINS LEAD ARE COLOURED IN ACCORDANCE WITH THE FOLLOWING CODE:

Blue: NEUTRAL
Brown: LIVE

As the colours of the wires in the mains lead of this apparatus may not correspond with the coloured markings identifying the terminals in your plug, proceed as follows:

The wire which is coloured BLUE must be connected to the terminal which is marked with the letter N or coloured BLACK. The wire which is coloured BROWN must be connected to the terminal which is marked with the letter L or coloured RED. Make sure that neither core is connected to the earth terminal of the three pin plug.

Limited Guarantee for European Economic Area (EEA) and Switzerland

Thank you for having chosen a Yamaha product. In the unlikely event that your Yamaha product needs guarantee service, please contact the dealer from whom it was purchased. If you experience any difficulty, please contact Yamaha representative office in your country. You can find full details on our website (<http://www.yamaha-hifi.com/> or <http://www.yamaha-uk.com/> for U.K. resident).

The product is guaranteed to be free from defects in workmanship or materials for a period of two years from the date of the original purchase. Yamaha undertakes, subject to the conditions listed below, to have the faulty product or any part(s) repaired, or replaced at Yamaha's discretion, without any charge for parts or labour. Yamaha reserves the right to replace a product with that of a similar kind and/or value and condition, where a model has been discontinued or is considered uneconomic to repair.

Conditions

1. The original invoice or sales receipt (showing date of purchase, product code and dealer's name) MUST accompany the defective product, along with a statement detailing the fault. In the absence of this clear proof of purchase, Yamaha reserves the right to refuse to provide free of charge service and the product may be returned at the customer's expense.
2. The product MUST have been purchased from an AUTHORISED Yamaha dealer within the European Economic Area (EEA) or Switzerland.
3. The product must not have been the subject of any modifications or alterations, unless authorised in writing by Yamaha.
4. The following are excluded from this guarantee:
 - a. Periodic maintenance and repair or replacement of parts due to normal wear and tear.
 - b. Damage resulting from:
 - (1) Repairs performed by the customer himself or by an unauthorised third party.
 - (2) Inadequate packaging or mishandling, when the product is in transit from the customer. Please note that it is the customer's responsibility to ensure the product is adequately packaged when returning the product for repair.
 - (3) Misuse, including but not limited to (a) failure to use the product for its normal purpose or in accordance with Yamaha's instructions on the proper use, maintenance and storage, and (b) installation or use of the product in a manner inconsistent with the technical or safety standards in force in the country where it is used.
 - (4) Accidents, lightning, water, fire, improper ventilation, battery leakage or any cause beyond Yamaha's control.
 - (5) Defects of the system into which this product is incorporated and/or incompatibility with third party products.
 - (6) Use of a product imported into the EEA and/or Switzerland, not by Yamaha, where that product does not conform to the technical or safety standards of the country of use and/or to the standard specification of a product sold by Yamaha in the EEA and/or Switzerland.
5. Where the guarantee differs between the country of purchase and the country of use of the product, the guarantee of the country of use shall apply.
6. Yamaha may not be held responsible for any losses or damages, whether direct, consequential or otherwise, save for the repair or replacement of the product.
7. Please backup any custom settings or data, as Yamaha may not be held responsible for any alteration or loss to such settings or data.
8. This guarantee does not affect the consumer's statutory rights under applicable national laws in force or the consumer's rights against the dealer arising from their sales/purchase contract.

Information for Users on Collection and Disposal of Old Equipment and Used Batteries



These symbols on the products, packaging, and/or accompanying documents mean that used electrical and electronic products and batteries should not be mixed with general household waste.

For proper treatment, recovery and recycling of old products and used batteries, please take them to applicable collection points, in accordance with your national legislation and the Directives 2002/96/EC and 2006/66/EC.



By disposing of these products and batteries correctly, you will help to save valuable resources and prevent any potential negative effects on human health and the environment which could otherwise arise from inappropriate waste handling.

For more information about collection and recycling of old products and batteries, please contact your local municipality, your waste disposal service or the point of sale where you purchased the items.



[Information on Disposal in other Countries outside the European Union]

These symbols are only valid in the European Union. If you wish to discard these items, please contact your local authorities or dealer and ask for the correct method of disposal.

Pb

Note for the battery symbol (bottom two symbol examples):

This symbol might be used in combination with a chemical symbol. In this case it complies with the requirement set by the Directive for the chemical involved.



© 2009 Yamaha Corporation All rights reserved.

YAMAHA CORPORATION
Printed in China Y WU20300