

Thank you for selecting this YAMAHA Soavo-900M speaker system.

## PRECAUTIONS

### Read this before using the speaker.

- To assure the finest performance, please read this manual carefully. Keep it in a safe place for future reference.
- Install the speaker in a cool, dry, clean place – away from windows, heat sources, sources of excessive vibration, dust, moisture and cold. Avoid sources of humming (transformers, motors). To prevent fire or electrical shock, do not expose the speaker to rain or water.
- To prevent the enclosure from warping or discoloring, do not place the speaker where it will be exposed to direct sunlight or excessive humidity.
- Do not place the following objects on the speaker:
  - Glass, china, etc.  
If glass etc. falls by vibrations and breaks, it may cause personal injury.
  - A burning candle etc.  
If the candle falls by vibrations, it may cause fire and personal injury.
  - A vessel with water in it  
If the vessel falls by vibrations and water spills, it may cause damage to the speaker, and/or you may get an electric shock.
- Do not place the speaker where foreign objects such as water drips might fall. It might cause a fire, damage to the speaker, and/or personal injury.
- Do not place the speaker where it is liable to be knocked over or struck by falling objects. Stable placement will also ensure better sound performance.
- Placing the speaker on the same shelf or rack as the turntable can result in feedback.
- Never put a hand or a foreign object into the port located on the rear of the speaker as this might cause personal injury and/or damage to the speaker.
- When moving the speaker, do not hold the port as it might cause personal injury and/or damage to the speaker.
- Any time you note distortion, reduce the volume control on your amplifier to a lower setting. Never allow your amplifier to be driven into “clipping”. Otherwise the speaker may be damaged.
- When using an amplifier with a rated output power higher than the nominal input power of the speaker, care should be taken never to exceed the speaker's maximum input.
- Do not attempt to clean the speaker with chemical solvents as this might damage the finish. Use a clean, dry cloth.
- Do not attempt to modify or fix the speaker. Contact qualified YAMAHA service personnel when any service is needed. The cabinet should never be opened for any reasons.
- **Secure placement or installation is the owner's responsibility.**  
**YAMAHA shall not be liable for any accident caused by improper placement or installation of the speaker.**

## PLACING THE SPEAKERS

Place the speakers on a sturdy, vibration-free surface, on a well-built stand.

### ■ Using as 2ch stereo speakers

Better stereo images will be obtained when the speakers are slightly angled in towards the listeners.

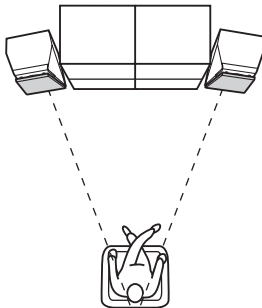

### ■ Using as front speakers in a multi channel system

Position the speakers on both sides of the TV. The positioning of speakers is important, because it controls the whole sound quality of a multi channel system. Set up the speakers on the basis of your listening position by following the owner's manual supplied with your amplifier.

### ■ Using as presence or surround speakers

Place the speakers on a shelf etc. Determine the best position by following the owner's manual supplied with your amplifier.

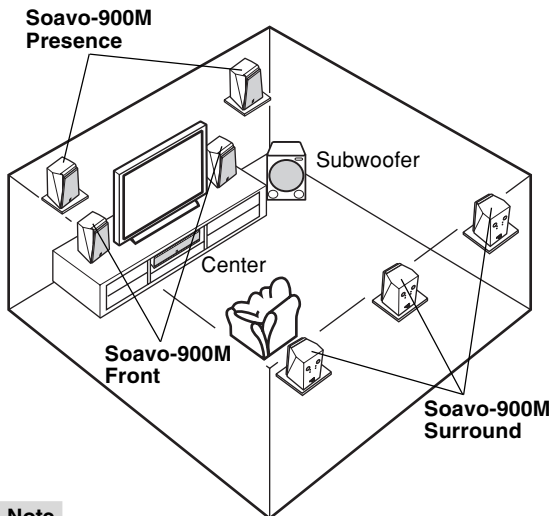

#### Note

This speaker features a magnetically shielded design, but there is still a chance that placing it too close to a TV set might impair picture color or create a buzzing noise. Should this happen, move the speaker away from the TV set.

### When hanging on a wall

You can hang the speaker on a wall using a commercially available bracket and screws.

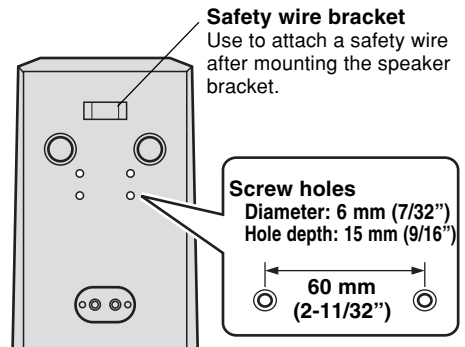

#### WARNING

- This speaker weighs 6.0 kg (13.4 lbs.). Do not mount it on thin plywood or a wall with soft surface material. If mounted, the screws may come out of the flimsy surface and the speaker may fall. This damages the speaker or causes personal injury.
- Do not install the speaker to a wall with nails, adhesives, or any other unstable hardware. Long-term use and vibrations may cause it to fall.
- To avoid accidents resulting from tripping over loose speaker cable, fix it to the wall.

## CONNECTION TO YOUR AMPLIFIER

**Before making connection, make sure that the amplifier is switched off.**

- Connect the screw-type terminals at the rear of the speakers to the speaker terminals of the amplifier with the speaker cable (sold separately).
- Connect the (+) terminals on the amplifier and the speakers using one side of the cable. Connect the (-) terminals on both components using the other side of the cable.
- Connect one speaker to the left (L) terminals of your amplifier, and another speaker to the right (R) terminals, making sure not to reverse the polarity (+, -). If one speaker is connected with reversed polarity, the sound will be unnatural and lack bass.

### How to connect:

- 1 Loosen the knob.
- 2 Remove the insulation coating at the extremity of each speaker cable by twisting the coating off.

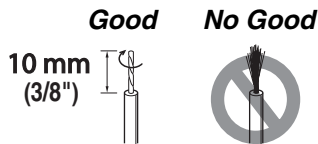

- 3 Insert the bare wire into the hole.
- 4 Tighten the knob and secure the cable. Test the firmness of the connection by pulling lightly on the cable at the terminal.

### Notes

- Do not let the bare speaker wires touch each other as this could damage the speaker or the amplifier, or both of them.
- Do not insert the insulation coating into the hole. The sound may not be produced.

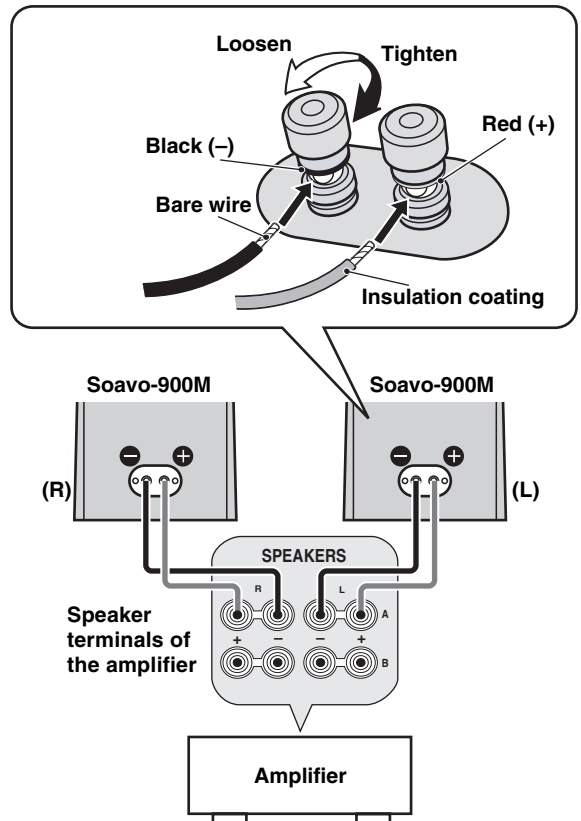

### When using a banana plug

- 1 Unscrew the terminal knob.
- 2 Remove the cover by pulling it toward you.
- 3 Tighten the terminal knob.
- 4 Simply insert the banana plug into the terminal.

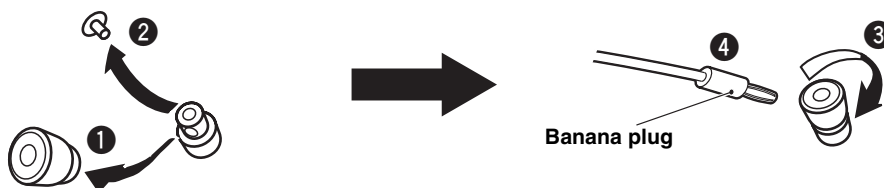

## ATTACHING THE FRONT COVER

The speaker and the front cover are packed separately. To attach the front cover, line up the four salients (magnet) on the reverse side of the front cover with the four corresponding pegs.

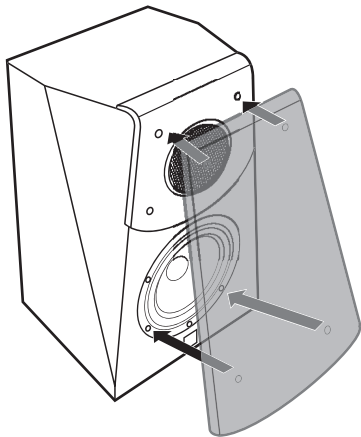

### Notes

- When the cover is not attached, take care not to touch the speaker units with your hands or to exert excessive force with tools.
- There are magnets on the reverse side of the front cover. Do not place the front cover close to objects that might be affected by magnets, such as TVs, clocks, magnetic cards, diskettes etc. when you don't use it.

## SPECIFICATIONS

Type .....	2-way bass reflex speaker system Magnetic shielding type
Driver .....	13 cm (5") cone woofer 3 cm (1") aluminum dome tweeter
Impedance .....	6 $\Omega$
Frequency Response .....	56 Hz to 50 kHz (-10 dB) to 100 kHz (-30 dB)
Nominal Input Power .....	30 W
Maximum Input Power .....	120 W
Sensitivity .....	87 dB/2.83 V/m
Crossover Frequency .....	3 kHz
Dimensions (W x H x D) .....	220 x 349 x 237 mm (8-11/16" x 13-3/4" x 9-5/16")
Weight .....	6.0 kg (13.4 lbs.)

- Specifications are subject to change without notice due to product improvements.
- Care should be taken not to exceed the input power values noted above.

### Taking care of the speaker

When you wipe this unit, do not use chemical solvents (ex. alcohol or thinners etc.); this might damage the finish. Use a clean, dry cloth. For heavy dirt, dampen a soft cloth in detergent diluted with the water, wring it out, and then clean this unit up with a soft cloth.