



Network Powered Speaker

NX-N500

OWNER'S MANUAL



CAUTION: READ THIS BEFORE OPERATING YOUR UNIT.

- 1 To assure the finest performance, please read this manual carefully. Keep it in a safe place for future reference.
- 2 Install this sound system in a well ventilated, cool, dry, clean place - away from direct sunlight, heat sources, vibration, dust, moisture, and/or cold. For proper ventilation, allow the following minimum clearances.
Top: 30 cm, Rear: 30 cm
- 3 Locate this unit away from other electrical appliances, motors, or transformers to avoid humming sounds.
- 4 Do not expose this unit to sudden temperature changes from cold to hot, and do not locate this unit in an environment with high humidity (i.e. a room with a humidifier) to prevent condensation inside this unit, which may cause an electrical shock, fire, damage to this unit, and/or personal injury.
- 5 Avoid installing this unit where foreign object may fall onto this unit and/or this unit may be exposed to liquid dripping or splashing. On the top of this unit, do not place:
 - Other components, as they may cause damage and/or discoloration on the surface of this unit.
 - Burning objects (i.e. candles), as they may cause fire, damage to this unit, and/or personal injury.
 - Containers with liquid in them, as they may fall and liquid may cause electrical shock to the user and/or damage to this unit.
- 6 Do not cover this unit with a newspaper, tablecloth, curtain, etc. in order not to obstruct heat radiation. If the temperature inside this unit rises, it may cause fire, damage to this unit, and/or personal injury.
- 7 Do not plug in this unit to a wall outlet until all connections are complete.
- 8 Do not operate this unit upside-down. It may overheat, possibly causing damage.
- 9 Do not use force on switches, knobs and/or cords.
- 10 When disconnecting the power cable from the wall outlet, grasp the plug; do not pull the cable.
- 11 Do not clean this unit with chemical solvents; this might damage the finish. Use a clean, dry cloth.
- 12 Only voltage specified on this unit must be used. Using this unit with a higher voltage than specified is dangerous and may cause fire, damage to this unit, and/or personal injury. Yamaha will not be held responsible for any damage resulting from use of this unit with a voltage other than specified.
- 13 To prevent damage by lightning, keep the power cable and outdoor antennas disconnected from a wall outlet or this unit during a lightning storm.
- 14 Do not attempt to modify or fix this unit. Contact qualified Yamaha service personnel when any service is needed. The cabinet should never be opened for any reasons.
- 15 When not planning to use this unit for long periods of time (i.e. vacation), disconnect the AC power plug from the wall outlet.
- 16 Be sure to refer to the “Troubleshooting” section of the Owner’s Manual for common operating errors before concluding that this unit is faulty.
- 17 Before moving this unit, press  (power) to set it to standby mode and disconnect the AC power plug from the wall outlet.
- 18 Condensation will form when the surrounding temperature changes suddenly. Disconnect the power cable from the outlet, then leave this unit alone.
- 19 When using this unit for a long time, this unit may become warm. Turn the power off, then leave this unit alone for cooling.
- 20 Install this unit near the AC outlet and where the AC power plug can be reached easily.

- 21 The batteries shall not be exposed to excessive heat such as sunshine, fire or the like. When you dispose of batteries, follow your regional regulations.
- 22 Excessive sound pressure from earphones and headphones can cause hearing loss.

WARNING

TO REDUCE THE RISK OF FIRE OR ELECTRIC SHOCK, DO NOT EXPOSE THIS UNIT TO RAIN OR MOISTURE.

This unit is not disconnected from the AC power source as long as it is connected to the wall outlet, even if this unit itself is turned off by . This state is called the standby mode. In this state, this unit is designed to consume a very small quantity of power.

Radio waves may affect electro-medical devices. Do not use this unit near medical devices or inside medical facilities.

Do not use this unit within 22 cm (9 inches) of persons with a heart pacemaker implant or defibrillator implant.

There is a chance that placing this unit too close to a CRT-based (Braun tube) TV set might impair picture color. Should this happen, move this unit away from the TV set.

■ Notes on remote controls and batteries

- Do not spill water or other liquids on the remote control.
- Do not drop the remote control.
- Do not leave or store the remote control in the following conditions:
 - places of high humidity, such as near a bath
 - places of high temperatures, such as near a heater or stove
 - places of extremely low temperatures
 - dusty places
- Insert the battery according to the polarity markings (+ and -).
- Change all batteries if you notice the following conditions:
 - the operation range of the remote control narrows
 - the transmit indicator does not flash or is dim
- If the batteries run out, immediately remove them from the remote control to prevent an explosion or acid leak.
- If you find leaking batteries, discard the batteries immediately, taking care not to touch the leaked material. If the leaked material comes into contact with your skin or gets into your eyes or mouth, rinse it away immediately and consult a doctor. Clean the battery compartment thoroughly before installing new batteries.
- Do not use old batteries together with new ones. This may shorten the life of the new batteries or cause old batteries to leak.
- Do not use different types of batteries (such as alkaline and manganese batteries) together. Specification of batteries may be different even though they look the same.
- Before inserting new batteries, wipe the compartment clean.
- Dispose of batteries according to your regional regulations.
- Keep batteries away from children. If a battery is accidentally swallowed, contact your doctor immediately.
- When not planning to use the remote control for long periods of time, remove the batteries from the remote control.
- Do not charge or disassemble the supplied batteries.

■ For U.K. customers

If the socket outlets in the home are not suitable for the plug supplied with this appliance, it should be cut off and an appropriate 3 pin plug fitted. For details, refer to the instructions described below.

Note

The plug severed from the mains lead must be destroyed, as a plug with bared flexible cord is hazardous if engaged in a live socket outlet.

■ Special instructions for U.K. model

IMPORTANT

THE WIRES IN MAINS LEAD ARE COLOURED IN ACCORDANCE WITH THE FOLLOWING CODE:

Blue: NEUTRAL

Brown: LIVE

As the colours of the wires in the mains lead of this apparatus may not correspond with the coloured markings identifying the terminals in your plug, proceed as follows:

The wire which is coloured BLUE must be connected to the terminal which is marked with the letter N or coloured BLACK. The wire which is coloured BROWN must be connected to the terminal which is marked with the letter L or coloured RED.

Making sure that neither core is connected to the earth terminal of the three pin plug.

■ Bluetooth

Bluetooth is a technology for wireless communication between devices within an area of about 10 meters (33 ft) employing the 2.4 GHz frequency band, a band which can be used without a license.

■ Handling Bluetooth communications

- The 2.4 GHz band used by *Bluetooth* compatible devices is a radio band shared by many types of equipment. While *Bluetooth* compatible devices use a technology minimizing the influence of other components using the same radio band, such influence may reduce the speed or distance of communications and in some cases interrupt communications.
- The speed of signal transfer and the distance at which communication is possible differs according to the distance between the communicating devices, the presence of obstacles, radio wave conditions and the type of equipment.
- Yamaha does not guarantee all wireless connections between this unit and devices compatible with *Bluetooth* function.

Information for Users on Collection and Disposal of Old Equipment and Used Batteries



These symbols on the products, packaging, and/or accompanying documents mean that used electrical and electronic products and batteries should not be mixed with general household waste.



For proper treatment, recovery and recycling of old products and used batteries, please take them to applicable collection points, in accordance with your national legislation and the Directives 2002/96/EC and 2006/66/EC.



Pb

By disposing of these products and batteries correctly, you will help to save valuable resources and prevent any potential negative effects on human health and the environment which could otherwise arise from inappropriate waste handling.

For more information about collection and recycling of old products and batteries, please contact your local municipality, your waste disposal service or the point of sale where you purchased the items.

[Information on Disposal in other Countries outside the European Union]

These symbols are only valid in the European Union. If you wish to discard these items, please contact your local authorities or dealer and ask for the correct method of disposal.

Note for the battery symbol (bottom two symbol examples):

This symbol might be used in combination with a chemical symbol. In this case it complies with the requirement set by the Directive for the chemical involved.

CONTENTS

Supplied accessories..... 4

FEATURES 5

What you can do with this unit 5

Mastering useful apps (MusicCast CONTROLLER).....5
Sources that can be played back on this unit.....5

Part names..... 6

Front panel6
Rear panel.....7
Remote control.....8

PREPARATIONS 9

PREPARATIONS..... 9

1 Connecting the left and right speakers9
2 Connecting the playback devices.....9
3 Connecting the network cables 10
4 Preparing a wireless antenna 10
5 Connecting the power cable..... 10
6 Positioning the speakers..... 11
Turning on the main power..... 11

Connecting to network 12

Connecting with the MusicCast CONTROLLER..... 12
Connecting without the MusicCast CONTROLLER..... 14

PLAYBACK 18

Playing back music stored on media servers
(PCs/NAS)..... 18

Setting the media sharing of music files 18
Playback of PC music contents..... 19

Playing back music on mobile devices
(Music Play)..... 20

Playback of mobile device music contents 20

Listening to Internet radio 21

Selecting an Internet radio station..... 21
Registering favorite Internet radio stations
(bookmarks)..... 21

Registering songs stations being played
back (Preset function) 22

Registering a song/station by remote control 22
Recalling a registered song/station by remote control 22

Playing back iPod/iTunes music via a
network (AirPlay) 23

Playback of iPod/iTunes music contents 23

Playing back music via *Bluetooth*..... 24

Registering a *Bluetooth* device with the unit (pairing)..... 24
Playing back audio from a *Bluetooth* device on the unit... 25
Disconnecting *Bluetooth* connection 25

Playing back music on a PC (USB DAC) 26

Installing the dedicated driver (Windows only) 26
Playing back music on a PC 26

Listening to music from a playback
device 27

Playback from devices with an optical digital audio
output 27
Playback from devices with an analog audio output 27

CONFIGURATIONS 28

Updating the unit's firmware via the
network..... 28

Updating with MusicCast CONTROLLER 28
Updating from this unit 28

Specifying unit settings with a web
browser 29

Configuring with Windows
(using a specified web browser)..... 29
Configuring with Mac OS 29
Displaying/changing settings..... 30

Restoring the default settings 32

Restoring the default settings (Factory reset)..... 32
Restoring the default network settings 32

APPENDIX 33

Troubleshooting..... 33

General..... 33
Bluetooth34
Remote control..... 34
Network..... 35

Supported devices and file formats..... 36

Supported devices 36
File formats 36

Specifications 37

Trademarks..... 38

Supplied accessories

Check that the following accessories are supplied with the product.

Remote control

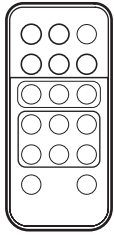

Power cable x 2

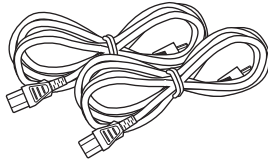

MusicCast Setup Guide



Balance cable
(3 m) x 1

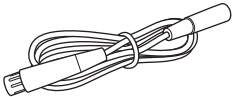

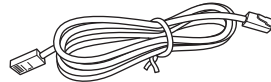

STP network cable (CAT-5 straight cable)
(for connecting the speakers)
(3 m) x 1

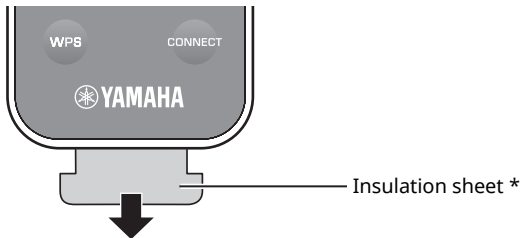

* Remove the insulation sheet of the remote control before using.



About this manual

- In this manual, iOS and Android mobile devices are collectively referred to as “mobile devices”. The specific type of mobile device is noted in explanations as needed.
-  indicates precautions for use of the unit and its feature limitations.
-  indicates supplementary explanations for better use.
- Updates offering improved functionality of the dedicated “MusicCast CONTROLLER” app for mobile devices may become available without prior notice.

What you can do with this unit

Mastering useful apps (MusicCast CONTROLLER)

You can operate and program the unit, or play streaming services via this unit, by installing the free dedicated MusicCast CONTROLLER app on a mobile device. For details, search for "MusicCast CONTROLLER" on the App Store or Google Play.



- "MusicCast CONTROLLER" supports the following mobile devices.
 - iOS version 7.1 or later
 - Android version 4.1 or later

MusicCast CONTROLLER capabilities

Various content and streaming services can be played.

- Play songs stored on computers (servers)
- Play music stored on mobile devices (Music Play)
- Select an Internet radio station
- Play music on streaming service
- Distribute and receive audio between the unit and other Yamaha MusicCast supported devices
- Select the input source, and adjust the volume or mute
- Adjust the tone and L/R balance, and set a sleep timer

See MusicCast Setup Guide for details.

Sources that can be played back on this unit

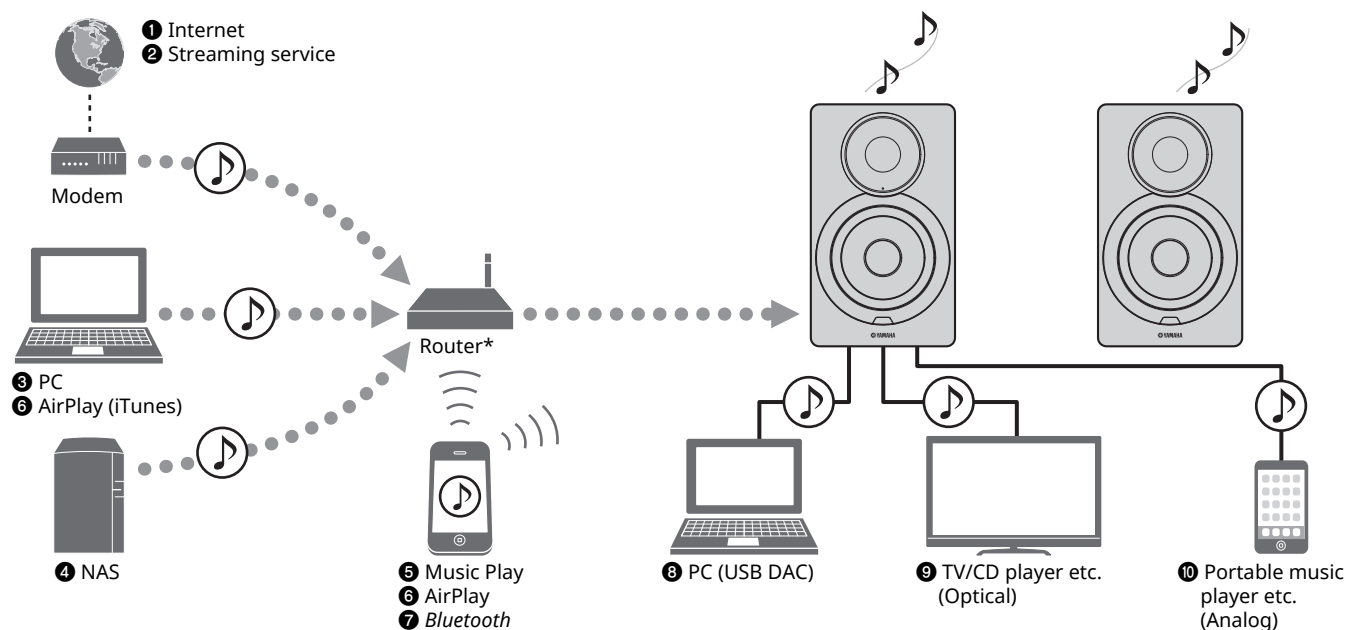

* You need a commercially available wireless router (access point) when you use a mobile device.

- 1 Play back the Internet radio (p.21)
- 2 Play back the streaming service (see the supplement for each service.)
- 3 Play back music files stored on your PC (p.18)
- 4 Play back music files stored on your NAS (p.18)
- 5 Play back music on mobile devices (Music Play) (p.20)
- 6 Play back music files stored on your iPod/iTunes with AirPlay (p.23)
- 7 Play back audio content from *Bluetooth* devices (p.24)
- 8 Play back audio on the PC (p.26)
- 9 Play back digital audio (p.27)
- 10 Play back analog audio (p.27)



- In order to play back from all audio sources, a mobile device installed with the dedicated "MusicCast CONTROLLER" app for mobile devices is necessary.

Part names

Front panel

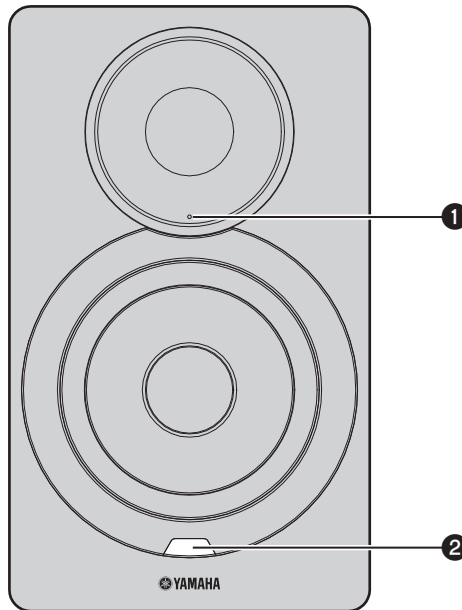

① Status indicator (left speaker only)

Indicates the selected input source and unit status depending on its color and whether it is lit or flashing. For details, refer to the “Table of status indicator conditions” at the back of this manual.

Orange	Standby
Yellow	Network standby
Green	Selecting the network input or setting up a network connection
Pink	Selecting the AirPlay input or standing by for an iOS device connection
Blue	<i>Bluetooth</i> input
Sky blue	USB input
Purple	Optical digital input
White	Selecting the AUX input or updating the firmware
Red	Error occurred



- If no network connection has been set up when the main power is turned on, the indicator flashing in pink, and the unit automatically searches for an iOS device (iPhone or iPod touch). For details on network connections with iOS devices, see “Sharing the iOS device setting” (p.15).

② Remote control sensor (left speaker only)

Receives infrared signals from the remote control (p.8).



- When using multiple units in the same room, turning off reception of the remote control signal with the web browser can prevent interference from other remote controls (p.29).

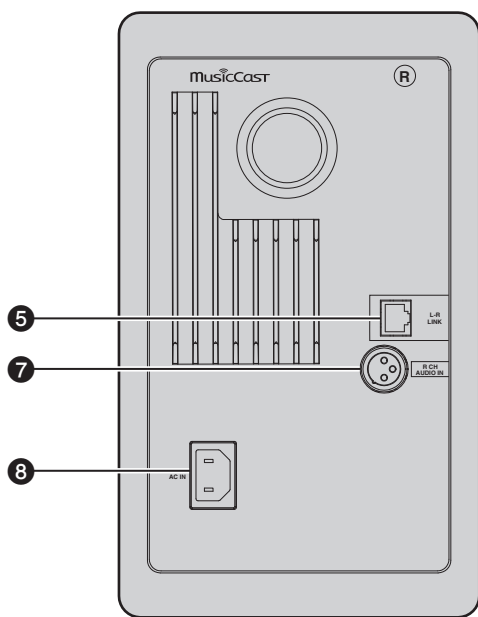

Right speaker

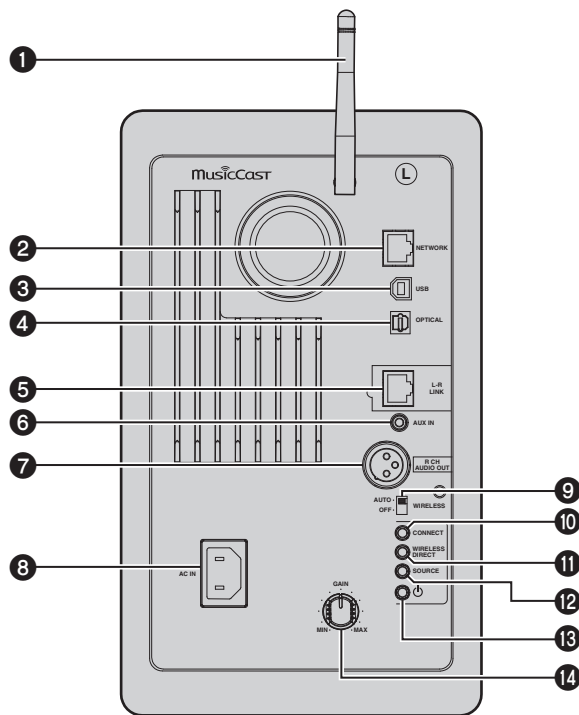

Left speaker

1 Wireless antenna

For connecting to a network device and *Bluetooth* device wirelessly (p.10).

2 NETWORK jack

For connecting to a network with a network cable (p.10).

3 USB jack

For connecting to a PC with a USB cable (p.26).

4 OPTICAL jack

For connecting to audio components equipped with optical digital output (p.27).

5 L-R LINK jack

For sending control information to the right speaker with the supplied network cable (p.9).

6 AUX IN jack

For connecting to audio components equipped with an analog output with a stereo mini plug cable (p.27).

7 R CH AUDIO OUT jack / R CH AUDIO IN jack

For sending audio to the right speaker with the supplied balance cable (p.9).

8 AC IN jack

For connecting the supplied power cable (p.10).

9 WIRELESS switch

Turns on/off wireless communications (wireless connection and *Bluetooth*).

10 CONNECT

Lets you operate the unit with the dedicated "MusicCast CONTROLLER" app for mobile devices (p.12).

11 WIRELESS DIRECT

Establishes a wireless connection directly with a mobile device or Wi-Fi-capable PC (p.17).

12 SOURCE

Selects the input source. Each press of this button switches the input source. The selected input source is indicated by the status indicator on the front panel (p.6).

13 (power) switch

Turns on/off the main power.

14 GAIN knob

Sets the maximum volume that the speakers can output. Adjust the maximum volume according to the playback device.



- When adjusting the maximum volume, play the audio from the playback device at its maximum volume, and then adjust the GAIN knob to play back at the desired volume.

AUTO	Enables wireless communications.
OFF	Disables wireless communications. Make a wired connection to connect to the network.



- When the unit is turned on, the wireless connection enters standby mode. If a wireless connection will not be used, set the WIRELESS switch to "OFF".

Remote control

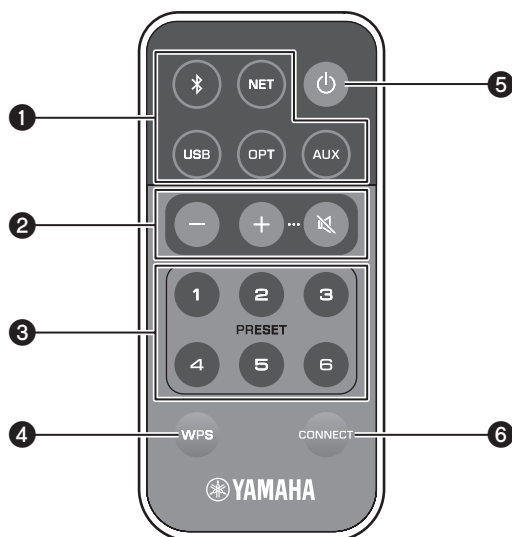

1 Input source selection keys

Select the input source for playback. The selected input source is indicated by the status indicator on the front panel (p.6).

(Bluetooth)	Bluetooth input
NET	Network input
USB	USB jack
OPT	OPTICAL jack
AUX	AUX jack



- To select network content, use the dedicated "MusicCast CONTROLLER" app for mobile devices. When NET is pressed, the previously played network content will be played back.

2 Volume adjustment keys

+/-	Adjust the volume for playback.
(mute)	Mutes the speaker output.



- To set the maximum volume, adjust the GAIN knob on the rear panel (p.7).

3 PRESET

Registers (presets) PC/NAS albums or songs, Internet radio stations and streaming stations on this unit. After a song/station is registered, it can be played back by simply pressing this key (p.22).

4 WPS

Sets up a wireless connection to the network (p.16).



- In order to connect to the network using WPS, a wireless router (or access point) with the WPS function is required.

5 (power)

Turns on/off (standby) the unit.



- To turn the main power on/off, use the (power) switch on the rear panel (p.7).

6 CONNECT

Lets you operate the unit with the dedicated "MusicCast CONTROLLER" app for mobile devices (p.12).

Operating by remote control

Use the remote control by directing it toward the remote control sensor on the left speaker.

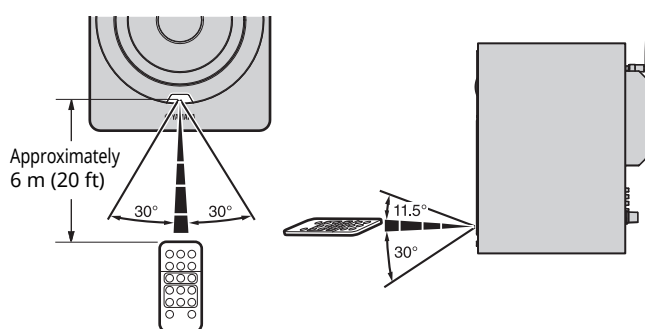

Replacing the battery

- Check the "+" of the battery and insert it the correct way around.
- While pushing the release tab in direction (A), slide out the battery holder in direction (B).

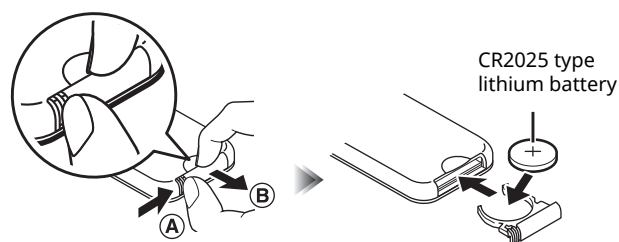

PREPARATIONS

1 Connecting the left and right speakers

Use the supplied cables to connect the left and right speakers.

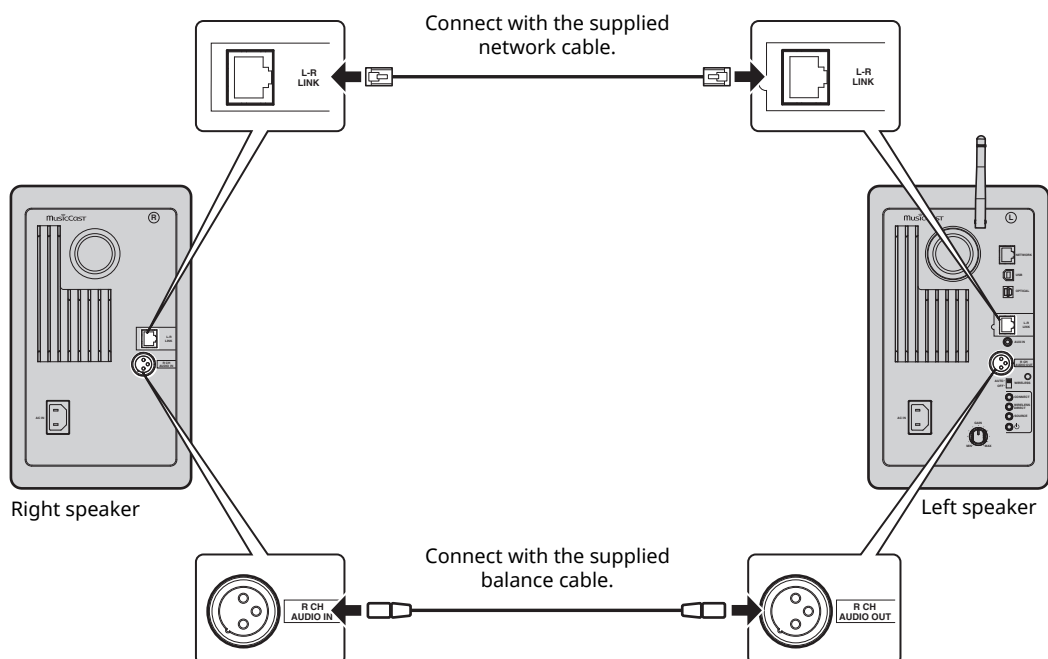

- If the left and right speakers are not connected, they will not function.
- Do not use any cable other than those supplied.

2 Connecting the playback devices

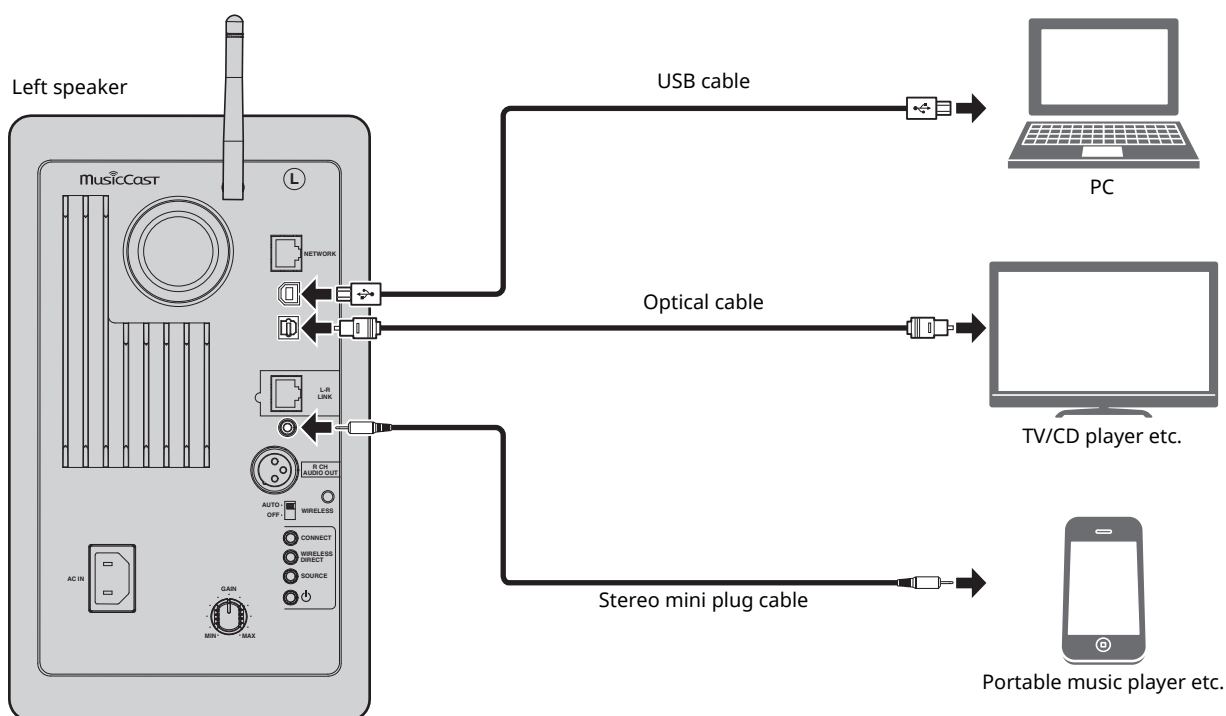

3 Connecting the network cables

Connect the unit to your router with a commercially-available STP network cable (CAT-5 or higher straight cable). Select whether to use a wired network connection or a wireless network connection, depending on your network environment. For details, refer to "Connecting to network" (p.12).

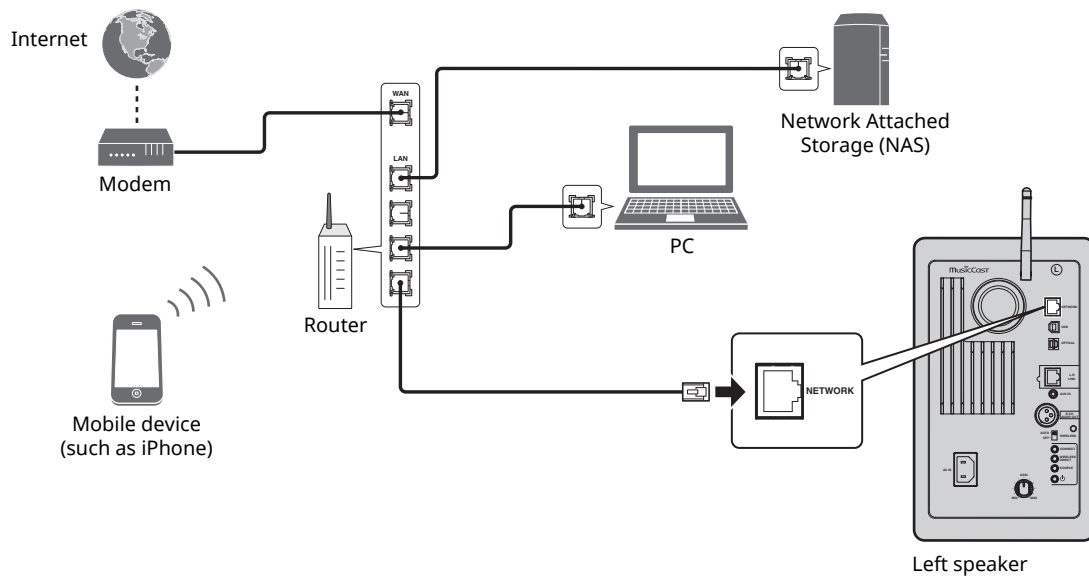

4 Preparing a wireless antenna

Raise the wireless antenna on the back of the left speaker.

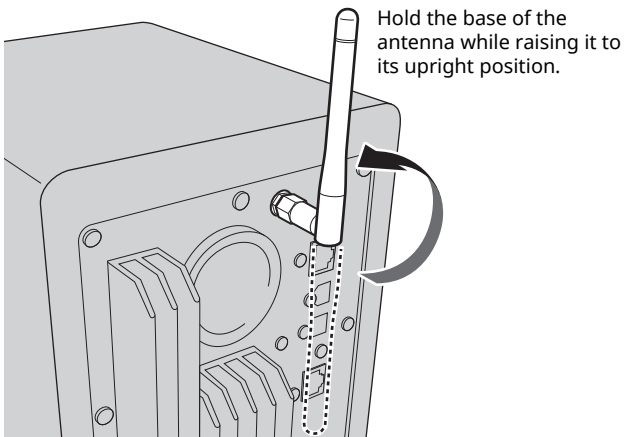

- Do not apply excessive force on the antenna. Doing so may damage it.
- Be sure to check the direction in which the antenna moves, and angle it in the proper direction.
- Do not remove the antenna.

5 Connecting the power cable

Connect the supplied power cable to the AC IN jack on the rear panel, and then insert the power plug into an AC wall outlet.

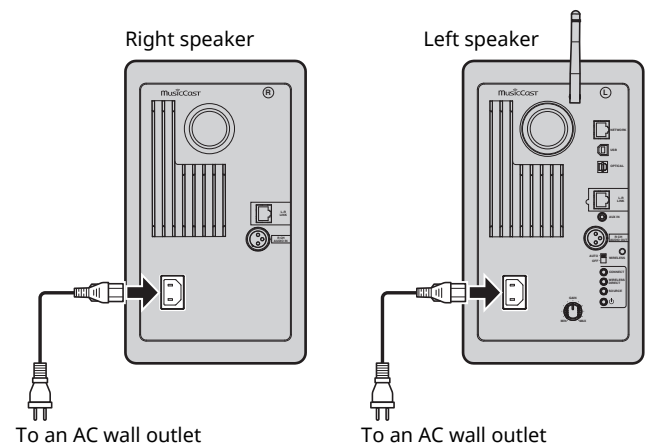

6 Positioning the speakers

- Place each speaker on a sturdy and stable surface.
- When connecting to a TV, place the speakers to the left and right of the TV.
- The ideal stereo effect will be obtained by slightly angling the front panels in toward the listener.

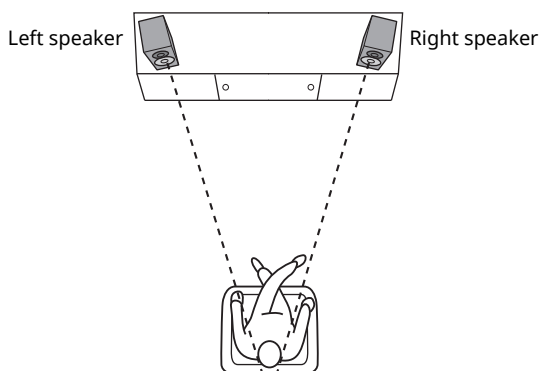

- When used near a CRT TV, separate the speakers from the TV if color distortions or noise occur.

Turning on the main power

After all cables have been connected, press the  (power) switch on the rear panel to turn on the main power of the unit.



- If no network connection has been set up when the main power is turned on, the indicator flashing in pink, and the unit automatically searches for an iOS device (iPhone or iPod touch). For details on network connections with iOS devices, see "Sharing the iOS device setting" (p.15).

Left speaker (rear panel)

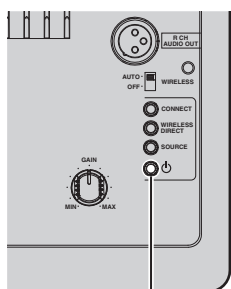

 (power) switch

Left speaker (front panel)

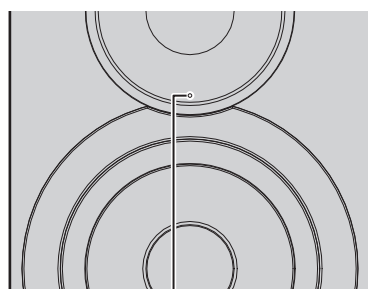

Pink

After the main power for the unit has been turned on, the unit can be turned on or switched to standby by using  (power) on the remote control.

To turn on/off the unit with the MusicCast CONTROLLER, the network function must be enabled, even when the unit is in standby mode (network standby).

For details on network standby, refer to the following section.

Network standby

The network function can be enabled, even when the unit is in standby mode (network standby).

If network standby is turned off, the unit can enter standby mode using the minimum standby power (eco standby).

Use the web browser on the PC to change the network standby setting (p.29).



- (U.K. model only) As a default, network standby is set to "Auto". If the unit has been disconnected from the network for 8 hours while it is in network standby mode, it switches to eco standby mode.

Auto power standby

If no operation is performed or nothing is played back, the unit will automatically enter standby mode (auto power standby).

MusicCast CONTROLLER can be used to change the auto power standby setting.

Standby time with no operation

All inputs:	8 hours
-------------	---------

Standby time with no playback

Network, Bluetooth and USB:	20 minutes
-----------------------------	------------

Default setting : On (U.K. model) / Off (Australia model)

Connecting to network



- Some security software installed on your PC or the firewall settings of network devices (such as a router) may block the access of the unit to the network devices or the Internet. In these cases, configure the security software or firewall settings appropriately.
- A connection cannot be established if the MAC address filter is enabled on the router. Check the router settings.
- Each server must be connected to the same subnet as the unit.
- To use the service via the Internet, broadband connection is strongly recommended.

Connecting with the MusicCast CONTROLLER

In order to use a mobile device installed with the dedicated "MusicCast CONTROLLER" app, simply follow the instructions in the MusicCast CONTROLLER screen to specify the network settings.

When playing a high-resolution audio source via the network, we recommend connecting with a wired router for stable playback.



- Connect the mobile device in which the "MusicCast CONTROLLER" app has been installed to the wireless router (access point) in advance.
- If this unit will not be connected to the Internet, streaming services such as Internet radio cannot be used. To use streaming services, connect the unit to a Internet with a wired router or wireless router (access point).

1 Perform the setup according to the network connection method (wired or wireless).

When connecting to the network using a cable:

Make sure that the unit is connected to the router with a cable.

When connecting to the network wirelessly:

If a wired connection has already been established, disconnect the network cable from the unit.

2 Set the WIRELESS switch on the rear panel to "AUTO".

Left speaker (rear panel)

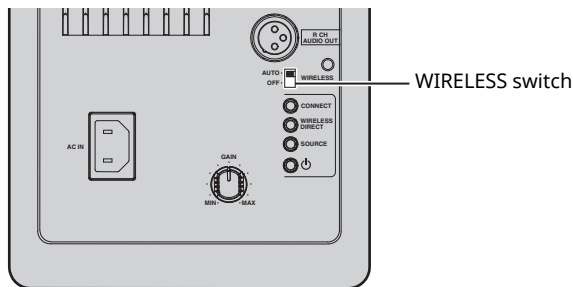

3 Start up the MusicCast CONTROLLER app on the mobile device, and then tap "Setup".

If you have already connected another MusicCast compatible device to the network, tap "Settings" and then "Add New Device".

4 Follow the procedure in the MusicCast CONTROLLER screen to turn on the unit.

While the connection is being set up, the status indicator on the front panel flashes in green.

Left speaker (front panel)

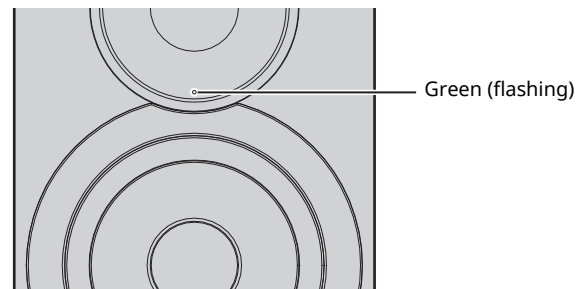

5 Hold down CONNECT on the remote control (or CONNECT on the rear panel) for at least 3 seconds.

Remote control

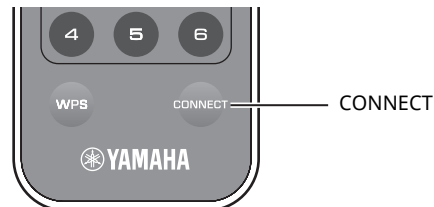

Left speaker (rear panel)

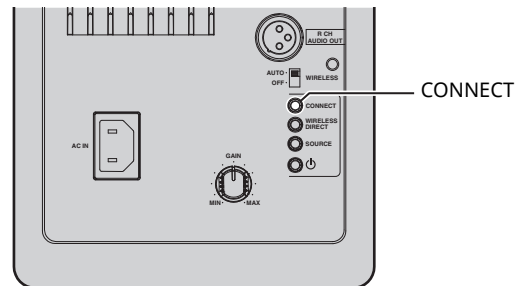

6 Follow the procedure in the MusicCast CONTROLLER screen to complete the network connection.

When the network connection is established, the status indicator on the front panel changes to lit.

Left speaker (front panel)

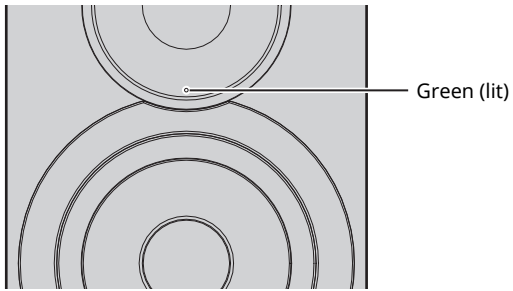

- If the input source is changed or this unit enters standby mode, the setup operation is canceled.

Connecting without the MusicCast CONTROLLER

To play back without using the MusicCast CONTROLLER, connect to the network with the method that corresponds to your environment.

When playing a high-resolution audio source via the network, we recommend connecting with a wired router for stable playback.

■ Connecting with the wired router

Connecting using the DHCP server function of the router



You can connect to the network by simply making a wired connection (p.15)

■ Connecting with a wireless router (access point)

Connect to the network with the method listed below that corresponds to your environment.

Connecting using the Wi-Fi setting of the iOS device (iPhone/iPod touch)



Share the Wi-Fi setting of the iOS device (p.15)

Connecting using WPS push button configuration on the wireless router (access point)



Use the WPS push button configuration (p.16)

Connecting with a wireless router (access point) without WPS push button configuration



Connect wirelessly with Wireless Direct (p.17) and set the connection setting using a web browser on the PC (p.29)

■ Connecting without a wired router or wireless router (access point)

Connecting wirelessly to a mobile device (Wireless Direct)



Connect wirelessly with Wireless Direct (p.17)



• When the unit is connected to the network with Wireless Direct, it cannot connect to any other wireless router (access point). To play back contents from the Internet, connect this unit to a network with a wired router or wireless router (access point).

■ Connecting to the network using a cable

As a default, this unit will automatically make a network connection when it is connected to a wired router and turned on.



- When connecting to the network using a cable, a network connection will be established regardless of whether the WIRELESS switch on the rear panel is set to "AUTO" or "OFF".
- If a wireless connection has already been established with this unit, the WIRELESS switch on the unit must first be set to "OFF". After turning off the unit and connecting the network cable, set the WIRELESS switch to "OFF", and then turn the unit on again. In order to use *Bluetooth*, turn on the unit before setting the WIRELESS switch to "AUTO".

1 Make sure that this unit is connected to the router with a cable.

2 Press (power) on the remote control to turn on the unit.

The network settings are automatically specified. While the settings are being specified, the status indicator on the front panel flashes in green.

Left speaker (front panel)

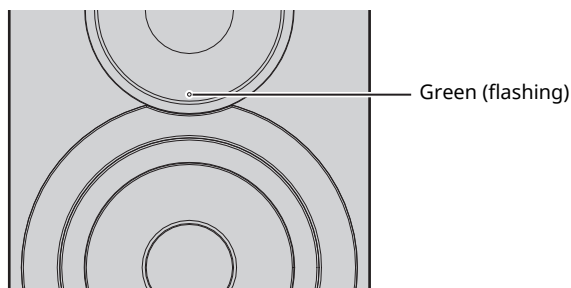

When the connection is established, the status indicator on the front panel changes to lit.

Left speaker (front panel)

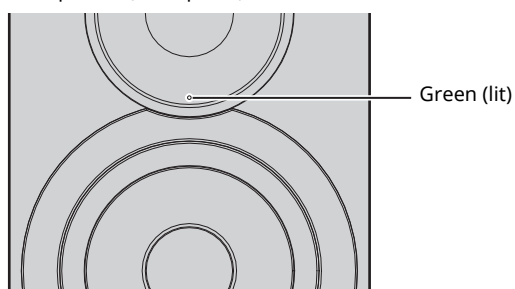

■ Sharing the iOS device setting

You can easily setup a wireless connection by applying the connection settings on iOS devices (iPhone/iPod touch). Before proceeding, confirm that your iOS device is connected to a wireless router (access point).



- In order to share Wi-Fi settings, the iOS device must be installed with iOS 7 or later.
- Following the procedure below will reset specified account information and registered preset settings.
- If network settings have already been specified, reset the network connection, and then follow the procedure below.



- If a wired connection has already been established with this unit, the WIRELESS switch on the unit must first be set to "OFF" while the unit is on. After disconnecting the network cable, set the WIRELESS switch to "AUTO".

1 Set the WIRELESS switch on the rear panel to "AUTO".

Left speaker (rear panel)

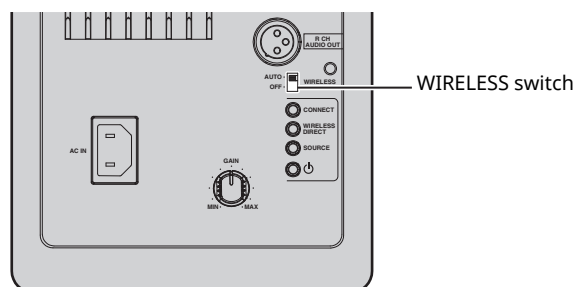

2 Press (power) on the remote control to turn on the unit.

The status indicator on the front panel flashes in pink.

Left speaker (front panel)

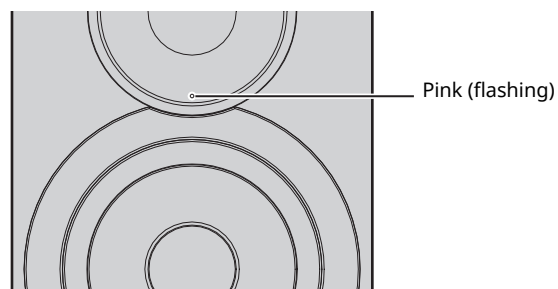

When this unit detects an iOS device, a connection confirmation message appears.

3 Tap "Allow" in the iOS device screen.

When the connection is established, the status indicator on the front panel lights up in green.

Left speaker (front panel)

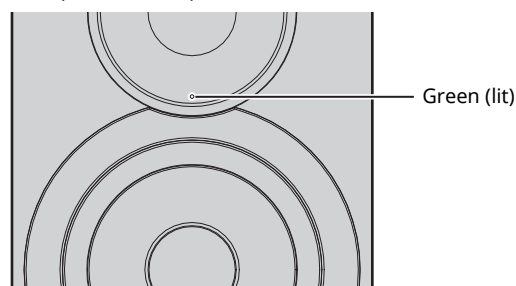

■ Using the WPS push button configuration

You can easily set up a wireless connection with one push of the WPS button.

1 Set the WIRELESS switch on the rear panel to "AUTO".

Left speaker (rear panel)

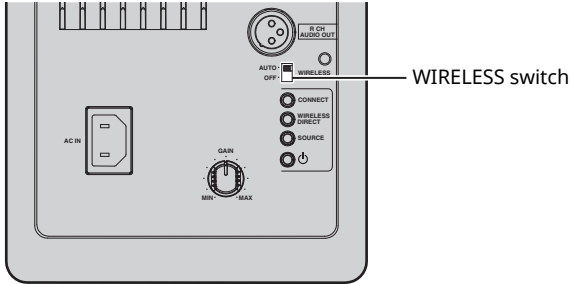

- If a wired connection has already been established with this unit, the WIRELESS switch on the unit must first be set to "OFF" while the unit is on. After disconnecting the network cable, set the WIRELESS switch to "AUTO".

2 Press (power) on the remote control to turn on the unit.

The status indicator on the front panel flashes in green.

Left speaker (front panel)

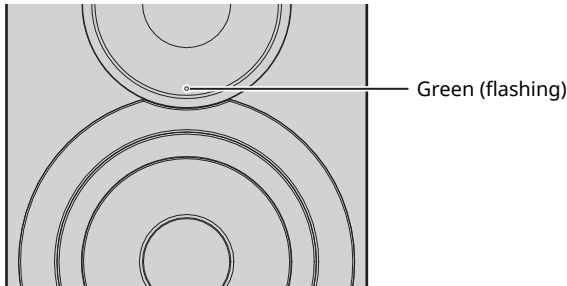

- If no network connection has been set up when the main power is turned on, the indicator lights up in pink, and the unit automatically searches for an iOS device (iPhone or iPod touch). For details on network connections with iOS devices, see "Sharing the iOS device setting" (p.15).

3 Hold down WPS on the remote control for 3 seconds.

The status indicator on the front panel flashes in green.

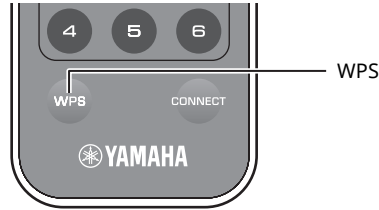

- If the input source is changed or this unit enters standby mode, the setup operation is canceled.

4 Press the WPS button on the wireless router (access point).

The WPS button on the wireless router (access point) must be pressed within 2 minutes after completing step 3. After 2 minutes have passed, the setup operation is canceled.

When the connection is established, the status indicator on the front panel lights up in green.

Left speaker (front panel)

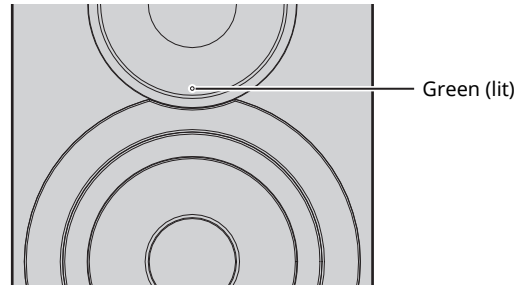

About WPS

WPS (Wi-Fi Protected Setup) is a standard established by the Wi-Fi Alliance, which allows easy establishment of a wireless home network.

■ Connecting a mobile device to the unit directly (Wireless Direct)

Using Wireless Direct, this unit can operate as a wireless network access point that mobile devices can directly connect to.



- When the unit is connected to the network with Wireless Direct, it cannot connect to any other wireless router (access point). To play back contents from the Internet, connect this unit to a network with a wired router or wireless router (access point).



- If a wired connection has already been established with this unit, the WIRELESS switch on the unit must first be set to "OFF" while the unit is on. After disconnecting the network cable, set the WIRELESS switch to "AUTO".
- If you do not have either a wired router or a wireless router (access point), you can specify the unit settings from a web browser by connecting your PC with Wireless Direct (p.29). Specify the same settings described below for mobile devices.

1 Set the WIRELESS switch on the rear panel to "AUTO".

Left speaker (rear panel)

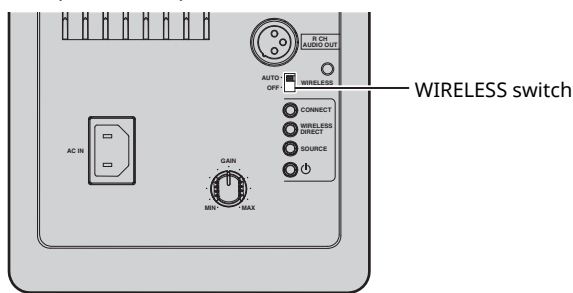

2 Hold down WIRELESS DIRECT on the rear panel for at least 3 seconds.

Left speaker (rear panel)

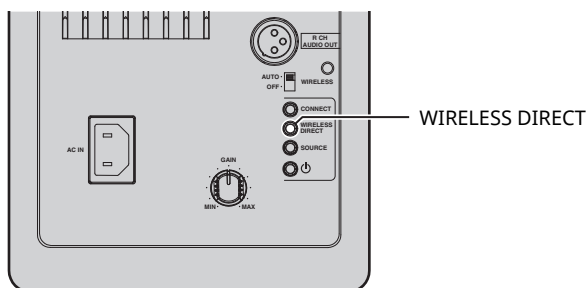

When the button is pressed, the status indicator on the front panel flashes in green. When the network settings begin to be specified, the status indicator changes to lit.

Left speaker (front panel)

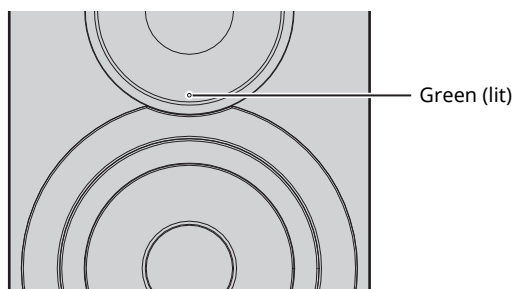

- To cancel the connection, hold down the WIRELESS DIRECT on the rear panel for at least 3 seconds. When the connection is canceled, the status indicator on the front panel flashes.
- If this unit had been connected to the network with any method other than those described above, canceling the connection returns the unit to the previous network connection.

3 Configure the Wi-Fi settings of a mobile device.

For details on settings of your mobile device, refer to the instruction manual of the mobile device.

- ① Enable the Wi-Fi function on the mobile device.
- ② Select the SSID of this unit from the list of available access points.
The SSID for this unit appears as "NX-N500 xxxxxx (Wireless Direct)" (where "xxxxxx" represents the unique alphanumeric).
- ③ If you are prompted for a password, enter "NX-N500password".



- If you want to change another network connection, set the WIRELESS switch on the rear panel to "OFF" and then "AUTO" to disconnect the Wireless Direct connection. After disconnecting, set the another network connection.
 - If you want to connect the network with MusicCast CONTROLLER, refer to "Connecting with the MusicCast CONTROLLER" (p.12) for details.
 - If you want to connect the network using this unit only, refer to "Connecting without the MusicCast CONTROLLER" (p.14) for details.

Playing back music stored on media servers (PCs/NAS)

You can play back music files stored on your PC or DLNA-compatible NAS on the unit.



- To use this function, the unit and your PC/NAS must be connected to the same router (p.10).
- To play back music files, the server software installed on the PC/NAS must support the music file formats that you want to play back.



- For details on playable file formats, see "Supported devices and file formats" (p. 36).
- You can connect up to 16 media servers to this unit.

Setting the media sharing of music files

To play back music files in your PC with this unit, you need to make the media sharing setting between the unit and PC (Windows Media Player 11 or later). In here, setting with Windows Media Player in Windows 7 is taken as an example.

■ When using Windows Media Player 12

- 1 Start Windows Media Player 12 on your PC.
- 2 Select "Stream", then "Turn on media streaming...".

The control panel window of your PC appears.

(Example of English version)

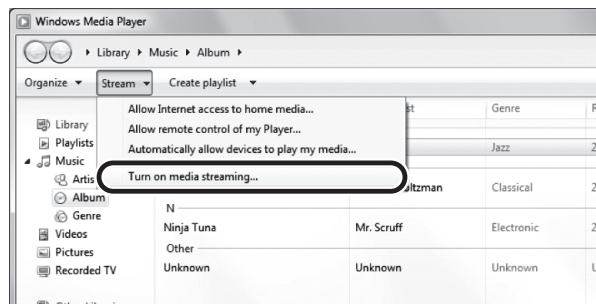

- 3 Click "Turn on media streaming".

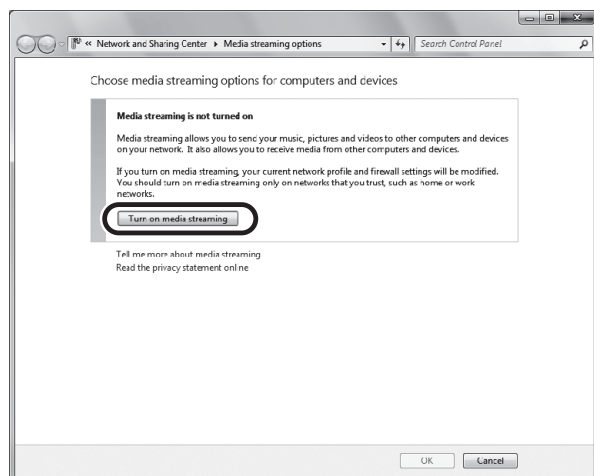

- 4 Select "Allowed" from the drop-down list next to the unit's model name.

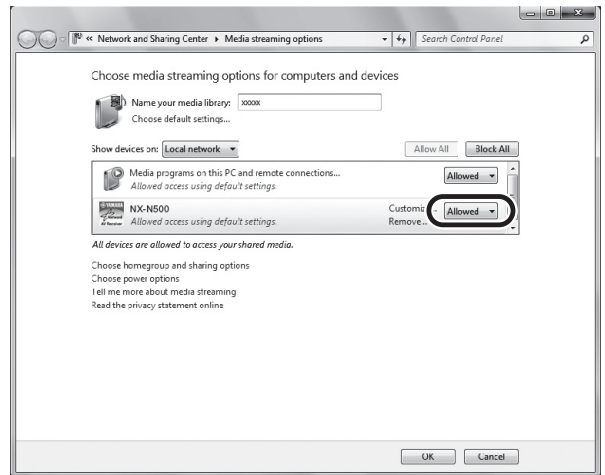

- 5 Click "OK" to exit.

■ When using Windows Media Player 11

- 1 Start Windows Media Player 11 on your PC.
- 2 Select "Library" then "Media Sharing".
- 3 Check the "Share my media to" box, select the unit's icon, then click "Allow".
- 4 Click "OK" to exit.

■ When using a PC or a NAS with other DLNA server software installed

Refer to the instruction manual for the device or software and configure the media sharing settings.

Playback of PC music contents

- 1** Start up the MusicCast CONTROLLER app on the mobile device.
- 2** In the MusicCast CONTROLLER screen, select the room name that was specified for this unit.
- 3** Select "Server" in the MusicCast CONTROLLER screen.
- 4** In the MusicCast CONTROLLER screen, select the music file to be played back.

Playing back music on mobile devices (Music Play)

Using a mobile device installed with MusicCast CONTROLLER, you can play back music files stored on your mobile device from this unit.



• For details on the music files compatible with this unit, see “Supported devices and file formats” (p. 36).

Playback of mobile device music contents

- 1 Start up the MusicCast CONTROLLER app on the mobile device.**
- 2 In the MusicCast CONTROLLER screen, select the room name that was specified for this unit.**
- 3 Select “This Phone” or “This Tablet” in the MusicCast CONTROLLER screen.**
The displayed name differs depending on the mobile device being used.
- 4 In the MusicCast CONTROLLER screen, select the music file to be played back.**

Listening to Internet radio

You can listen to Internet radio stations from all over the world.



- You may not be able to receive some Internet radio stations.
- The unit uses the vTuner Internet radio station database service.
- This service may be discontinued without notice.

Selecting an Internet radio station

- 1 Start up the MusicCast CONTROLLER app on the mobile device.**
- 2 In the MusicCast CONTROLLER screen, select the room name that was specified for this unit.**
- 3 Select "Net Radio" in the MusicCast CONTROLLER screen.**
- 4 In the MusicCast CONTROLLER screen, select the radio station to be tuned into.**



- Up to 40 radio stations can be registered (preset) (p.22).

Registering favorite Internet radio stations (bookmarks)

By registering your favorite Internet radio stations to "Bookmarks", you can quickly access to them from "Bookmarks".

- 1 Select any of Internet radio stations on the unit.**
This operation is necessary to register the radio station for the first time.
- 2 Check the vTuner ID of the unit.**
You can find the vTuner ID (MAC address of the unit) with the MusicCast CONTROLLER app.
- 3 Access the vTuner website (<http://yradio.vtuner.com/>) with the web browser on your PC and enter the vTuner ID.**

You can switch the language.



Enter the vTuner ID in this area.



- To use this feature, you need to create your personal account. Create your account using your e-mail address.

- 4 Register your favorite radio stations.**

Click the "Add" icon (♥+) next to the station name.



- To remove the station from the "Bookmarks" folder, select "Bookmarks" in the Home screen, and then click the "Remove" icon (♥-) next to the station name.

Registering songs stations being played back (Preset function)

Up to 40 albums or songs stored on the PC/NAS , Internet radio stations and streaming stations can be registered on this unit and easily recalled at any time (when using the MusicCast CONTROLLER).

The first 6 presets can be registered/recalled by using this unit's remote control.



• For details on the procedures to register/recall with MusicCast CONTROLLER, refer to the app's instructions.

Registering a song/station by remote control

- 1 Play the song/station to be registered.
- 2 Hold down any of PRESET 1 to 6 on the remote control for 5 seconds.

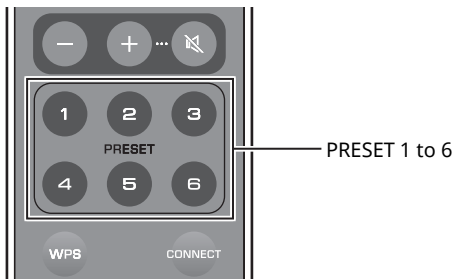

When the registration is finished, the status indicator on the front panel flashes twice in green.

Left speaker (rear panel)

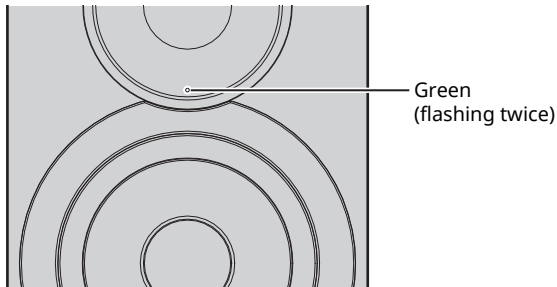

- If the status indicator flashes twice in red, the selected song/station cannot be registered. Try with a different song/station.
- If PRESET where a song/station has already been registered is held down for 5 seconds, the previous setting is overwritten.

Recalling a registered song/station by remote control

- 1 On the remote control, press PRESET where the song/station is registered.



- If the registered PRESET is pressed while the unit is in standby mode, the unit automatically turns on, and the registered song/station is played.

Playing back iPod/iTunes music via a network (AirPlay)

The AirPlay function allows you to play back iPod/iTunes music on the unit via network.

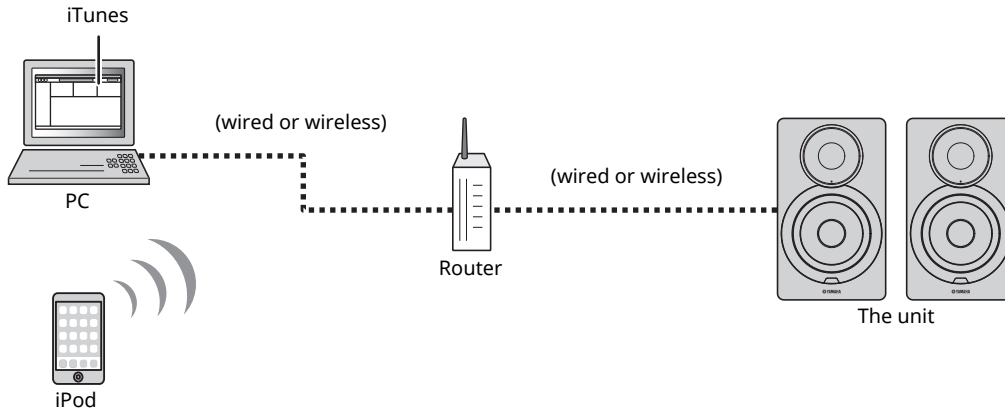

• For details on supported iPod devices, see “Supported devices and file formats” (p. 36).

Caution

- When you use iPod/iTunes controls to adjust volume, the volume may be unexpectedly loud. This could result in damage to the unit or speakers. If the volume suddenly increases during playback, stop playback on the iPod/iTunes immediately.

Playback of iPod/iTunes music contents

Follow the procedure below to play back iPod/iTunes music contents on the unit.

1 Turn on the unit, and start iTunes on the PC or display the playback screen on the iPod.

If the iPod/iTunes recognizes the unit, the AirPlay icon () appears.



- For iPods using iOS 7/8, AirPlay icon is displayed in Control Center. To access Control Center, swipe up from the bottom of the screen.

example

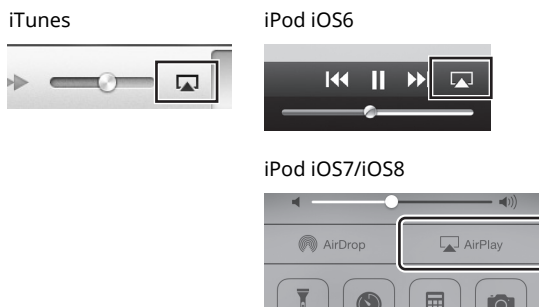

- If the icon does not appear, check whether the unit and PC/iPod are connected to the router properly.

2 On the iPod/iTunes, click (tap) the AirPlay icon and select the unit (network name of the unit) as the audio output device.

example

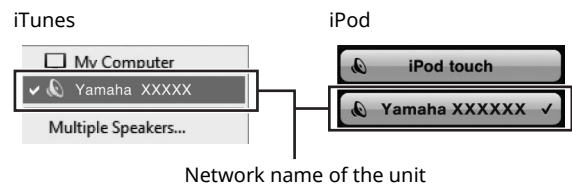

3 Select a song and start playback.

The unit automatically selects “AirPlay” as the input source and starts playback.



- If network standby is turned on “Network standby” (p. 11), this unit automatically turns on when playback on iTunes/iPod is started.
- The network name for this unit that appears in iTunes/iPod can be changed using the web browser on the PC (p.29).
- You can adjust the unit’s volume from the iPod/iTunes during playback.

Playing back music via *Bluetooth*

You can play back music files stored on a *Bluetooth* device (such as mobile device) on the unit.



- When you playing the *Bluetooth* device, set the WIRELESS switch on the rear panel to "AUTO" (p.7).

Registering a *Bluetooth* device with the unit (pairing)

1 Press (*Bluetooth*) on the remote control.

If no *Bluetooth* device has been registered yet, the status indicator on the front panel flashes in blue.

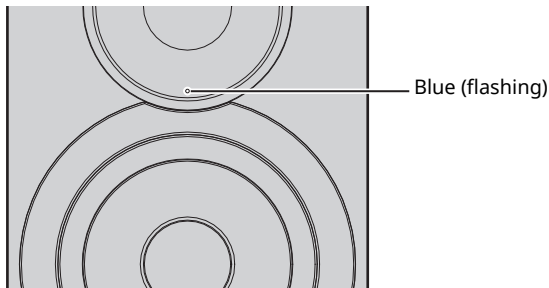
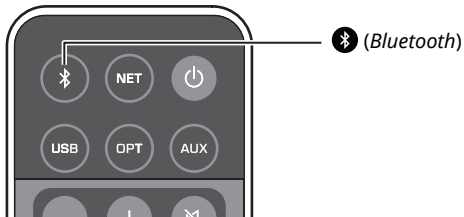

2 Turn on the *Bluetooth* function on the *Bluetooth* device.

The operation varies depending on the device. Refer to the instruction manual supplied with the device.

3 Select "NX-N500 XXXXXX Bluetooth" in the *Bluetooth* device list on the device.

Where "xxxxxx" represents the unique alphanumeric.

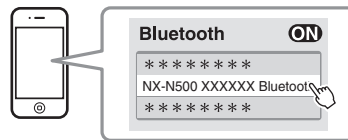

- If this unit has been registered with the MusicCast CONTROLLER, the room name entered during registration appears.

If or a connection completed message appears on the paired device, pairing is finished.

When pairing is finished, the status indicator changes to lit.

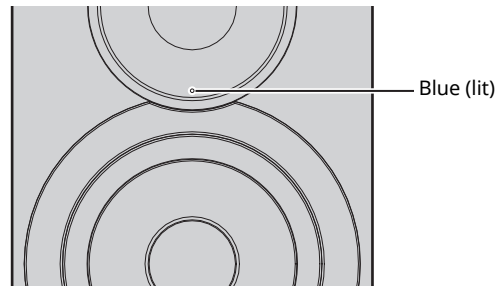

4 Playback a song on the *Bluetooth* device.

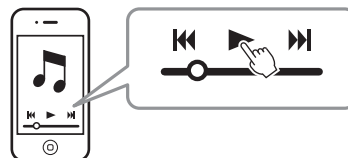

- Perform pairing with the *Bluetooth* device and unit within 10 m (33 ft) of each other.
- This unit can be paired with a maximum total of 20 *Bluetooth* devices for reception and transmission. When the 21st device is registered, the least frequently used pairing information is deleted.
- If a *Bluetooth* device has been connected before, the unit will connect to the last connected device when (*Bluetooth*) is pressed with step 1. Disconnect this connection to pair a new device (p.25).
- Refer to "Bluetooth" (p. 34) in "Troubleshooting" if pairing is not possible.

Playing back audio from a *Bluetooth* device on the unit

1 Press (*Bluetooth*) on the remote control.

The input source switches to *Bluetooth*.

2 Turn on the *Bluetooth* function on the *Bluetooth* device.

Specifying connection setting

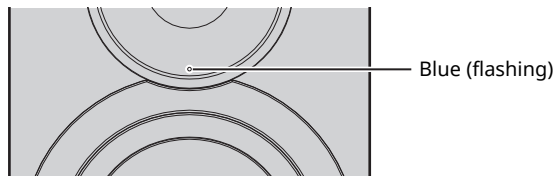

Connection established

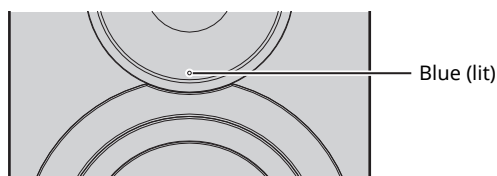

3 Play back a song on the *Bluetooth* device.

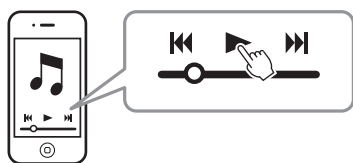

- Perform *Bluetooth* connection with the device and unit within 10 m (33 ft) of each other.
- If necessary, select this unit again from the *Bluetooth* device list on the paired device. Depending on your device, it may be necessary to select this unit as the audio output.
- Adjust *Bluetooth* device volume as needed.
- If a *Bluetooth* device has been connected before, the unit will connect to the last connected device when  (*Bluetooth*) is pressed with step 1. Disconnect this connection to pair a new device (p.25).

Disconnecting *Bluetooth* connection

Bluetooth connection is disconnected in the following cases. When the connection is disconnected, the status indicator on the front panel of this unit flashes in blue.

- The connection is disconnected from the *Bluetooth* device, or the *Bluetooth* device is turned off.
-  (*Bluetooth*) on the remote control is held down for at least 5 seconds.
- The unit is turned off.

Playing back music on a PC (USB DAC)

When a PC is connected to the USB jack of the unit, the unit functions as a USB DAC, enabling audio output on the PC to be played.

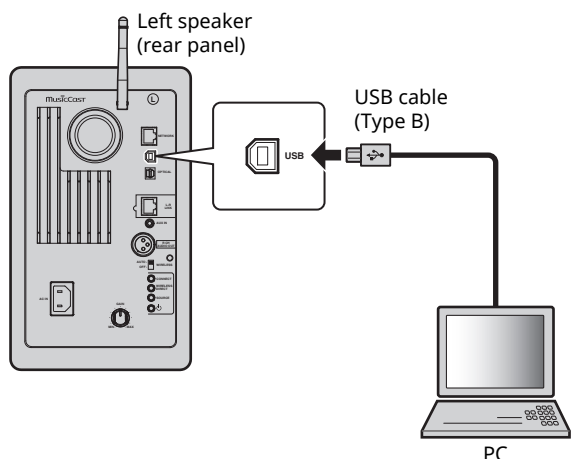

For details on supported operating systems and sampling formats, see “Supported devices and file formats” (p. 36).



• When using Mac OS, it is not necessary to install a driver. The audio driver of Mac OS is available for playback.



• Operations may not be executed correctly if the PC is connected to this unit before the driver is installed.

Installing the dedicated driver (Windows only)

Before connecting a PC to the unit, installing the dedicated driver on the PC.

- 1 Access the following URL, download the dedicated driver “Yamaha HiFi USB Driver,” then extract and execute the file.

Website for downloading the exclusive driver
URL: <http://download.yamaha.com/>

- 2 Install the downloaded “Yamaha HiFi USB driver” on the PC.

For details, refer to the Installation Guide supplied with the downloaded driver.

- 3 When installation is complete, quit all running applications.



• The “Yamaha HiFi USB Driver” is subject to change without prior notice. For details and the latest information, refer to the downloading page for the driver.

Playing back music on a PC

- 1 Connect the PC to the unit, using USB cable.
- 2 Turn on the PC.
- 3 Press  (power) on the remote control to turn on the unit.

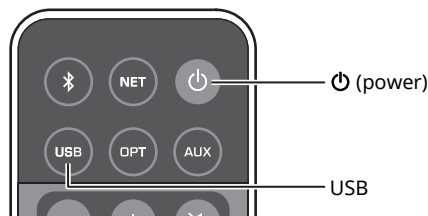

- 4 Press USB on the remote control.

The status indicator on the front panel lights up in sky blue.

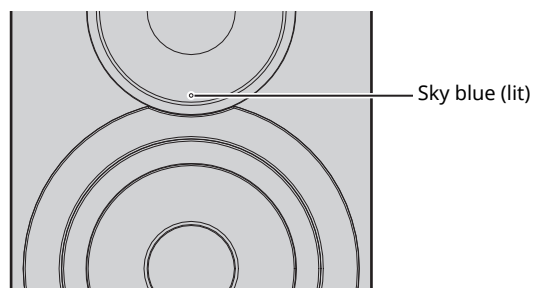

- 5 Set the audio output destination of the PC to “Yamaha NX-N500”.

With Windows OS:

Control panel → Hardware and sound → Sound → [Playback] tab

With Mac OS:

System Preferences → Sound → [Output] tab

The setting may vary, depending in the operating system. For details, consult the manufacture of your PC.

- 6 Operate the PC to start playback of music files.

■ Adjusting the sound volume

To obtain higher sound quality, set the sound volume at the PC to the maximum, and gradually increase the volume at the unit from the minimum to your desired level.



- Do not disconnect the USB cable, turn of the unit, or change the input while playback on a PC connected via the USB cable is in progress. Doing so may cause a malfunction.
- To mute operation sounds of the PC during music playback, change the setting on the PC.
- If music files cannot be played correctly, restart the PC and perform the mentioned procedure again.

Listening to music from a playback device

Music from a playback device can be enjoyed from this unit by connecting the playback device to the OPTICAL jack or AUX jack of this unit.

Playback from devices with an optical digital audio output



- The optical digital input of this unit is compatible only with PCM. If the optical digital output of the playback device is AAC, such as on a TV, switch it to PCM.

1 Connect this unit and the playback device using an optical digital cable.

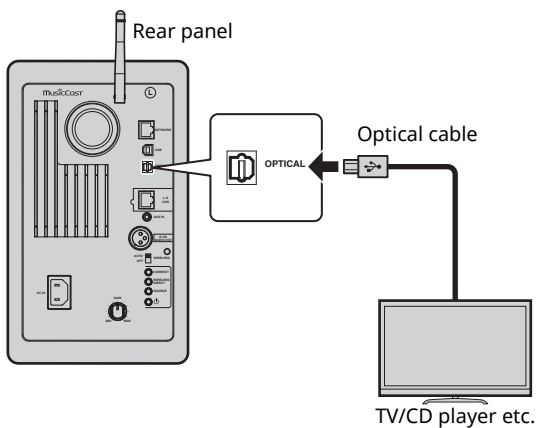

2 Press **⏻** (power) on the remote control to turn on the unit.

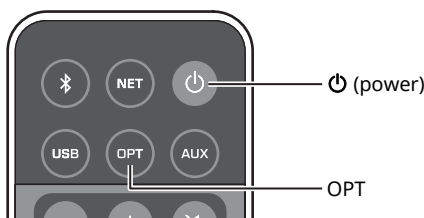

3 Press **OPT** on the remote control.

The status indicator on the front panel lights up in purple.

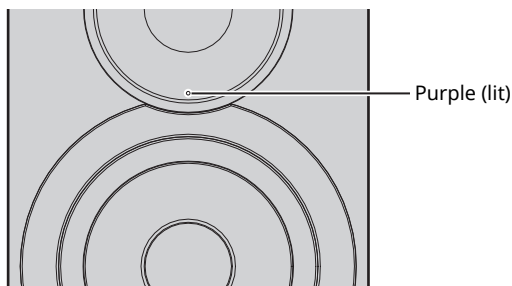

4 Play back the music from the playback device.

Playback from devices with an analog audio output

1 Connect this unit and the playback device using a stereo mini plug cable.

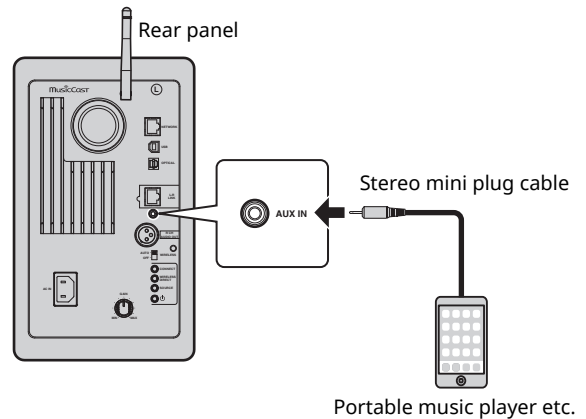

2 Press **⏻** (power) on the remote control to turn on the unit.

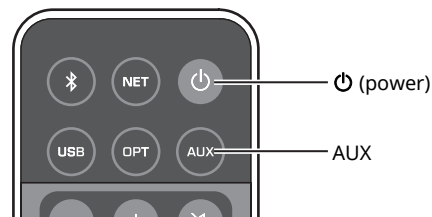

3 Press **AUX** on the remote control.

The status indicator on the front panel lights up in white.

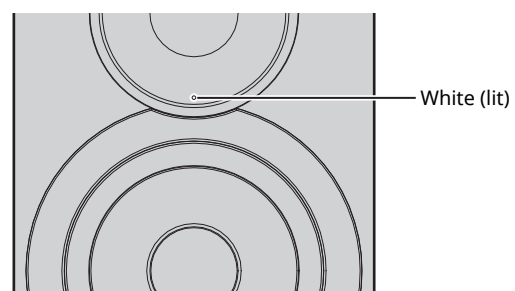

4 Play back the music from the playback device.

■ Adjusting the sound volume

To obtain higher sound quality, set the sound volume at the playback device to the maximum, and gradually increase the volume at the unit from the minimum to your desired level.

Updating the unit's firmware via the network

New firmware that provides additional features or product improvements will be released as needed. If the unit is connected to the Internet, you can download the firmware via the network and update it.

The firmware can be updated using any of the following procedures.

- Updating from a mobile device installed with the dedicated "MusicCast CONTROLLER" app for mobile devices
- Updating from this unit
- Updating from a web browser, for example, on a PC (p.29)

Caution

- Do not operate the unit or disconnect the power cable or network cable during firmware update. Firmware update takes about 20 minutes or more (depending on your Internet connection speed).
- If the unit is connected to the wireless network, network update may not be possible depending on the condition of the wireless connection. In this case, take the time to try updating the firmware.
- For details on update, visit the Yamaha website.



- The firmware can also be updated from a web browser on a PC (p.29).

Updating with MusicCast CONTROLLER

When a new firmware update is available, a message prompting you to update appears in the MusicCast CONTROLLER screen.

Follow the procedure in the MusicCast CONTROLLER screen to update the firmware.

After the update is finished, turn the unit off, then on again, as instructed in the screen.

Updating from this unit

When a new firmware update is available, the status indicator on the front panel flashes in white when the unit is turned on.

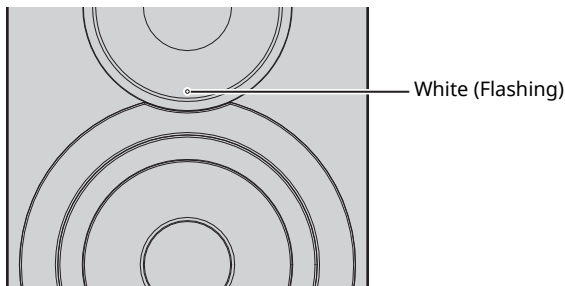

Follow the procedure below to update the firmware.

- 1 Turn off the unit.**
- 2 While holding down SOURCE on the rear panel, press the ⏻ (power) switch to turn on the unit.**
The firmware update starts.

Left speaker (Rear panel)

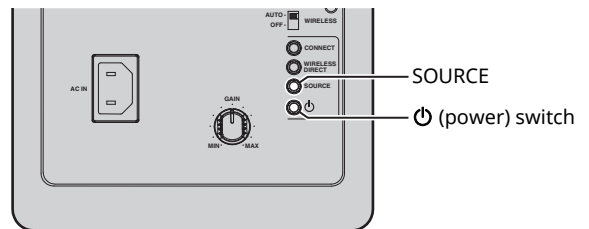

Updating

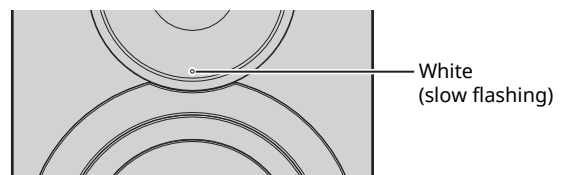

Complete

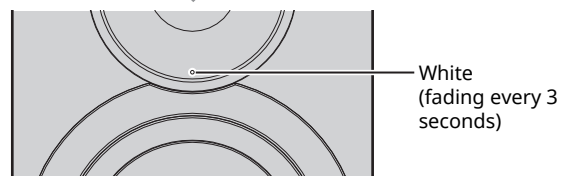

- If an error occurred during firmware updating, the status indicator will repeatedly flash three times in red. To restart updating, press WIRELESS DIRECT on the rear panel.
- If the firmware download cannot be found, the status indicator will repeatedly flash twice in red. Check that this unit is connected to the network.

- 3 Turn the unit off, then on again.**

Specifying unit settings with a web browser

A web browser on a PC can be used to display or specify the various unit settings as well as the network connection settings. Perform the following operations with the unit connected to the network wirelessly or using a cable, or connected directly to the PC with Wireless Direct (p.17).



- Some security software installed on your PC may block access by the unit. In that case, configure the security software appropriately.
- This feature is compatible with operating systems of the following versions.
 - Windows 7 or later
 - Mac OS 10.7.x or later
- We recommend using a web browser of the following versions.
 - Internet Explorer 9/10/11
 - Safari 8

Configuring with Windows (using a specified web browser)

1 Open the "Network" folder.

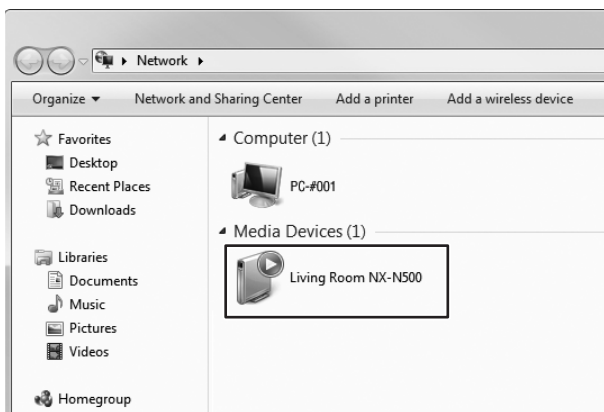

2 Double-click this unit, which appears below "Other Devices" or "Media Devices".

Start up the specified web browser. The configuration window for the unit appears.

Configuring with Mac OS

1 Start up Safari, and then click "Preferences", then "Advanced".

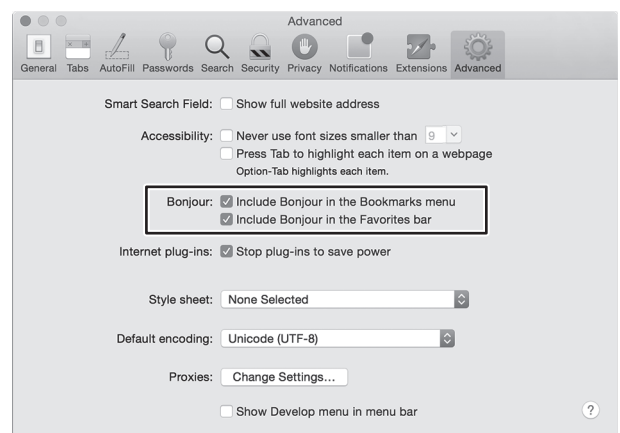

2 Select all check boxes for Bonjour.

Select this unit from the Bookmarks menu list.

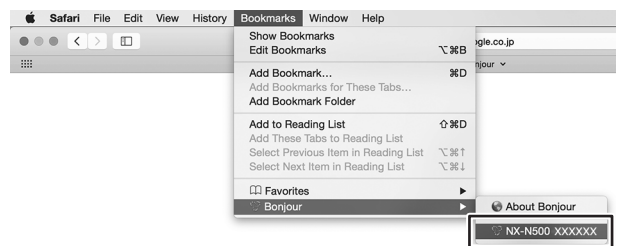

The configuration window for the unit appears.

Displaying/changing settings

Settings for the following parameters can be displayed or changed.

■ Network Name

Edits the unit's name that appears on the network.

Network Name	Enter the unit's name that will appear on the network. If this unit has been registered with the MusicCast CONTROLLER, the room name entered during registration appears.
APPLY	Click to apply the new name.

■ Network Setup

Specifies the network settings.



- Some of the following parameters may not appear (or their settings cannot be changed), depending on the selected network connection method.

Connection Info	Displays the currently specified network connection method.		
MusicCast Network	Displays the MusicCast network status. If "Ready" appears, the MusicCast CONTROLLER can be used.		
Connection Select	Select the network connection method (Wired LAN/Wireless LAN/Wireless Direct/MusicCast Wireless).		
	With Wireless LAN	WPS PIN	Displays the WPS PIN code.
		SSID	Enter the SSID for the wireless router (access point).
With Wireless LAN/Wireless Direct	Security	Select the security method when connecting with a wireless router (access point) or Wireless Direct.	
	Security Key	Enter the security key when connecting with a wireless router (access point) or Wireless Direct.	
DHCP	Switches on/off the DHCP function. When turned off, some settings, such as the IP address and subnet mask, can be specified manually.		
IP Address	Displays the IP address for this unit.		
Subnet Mask	Displays the subnet mask for this unit.		
Default Gateway	Displays the default gateway for this unit.		
DNS Server (P)	Displays the address of the primary DNS server.		
DNS Server (S)	Displays the address of the secondary DNS server.		
APPLY	Click to apply the currently specified settings.		

When connecting with a wireless router (access point) using a WPS PIN code, follow the procedure below to specify the settings.

1 Set "Connection Select" to "Wireless LAN", and then click "APPLY".

2 Select the "WPS PIN" check box, and then click "APPLY".

The PIN code appears at the message window.

3 Enter the PIN code for the unit into the wireless router (access point).

■ AirPlay Password

Specifies the password for AirPlay playback.

Mode	Switches on/off the password function. When turned on, a password can be specified.
Password	Enter the password to be specified.
APPLY	Click to apply the specified settings.

■ Firmware Update

Updates the firmware of this unit.

Current Firmware Version	Displays the version of the current firmware.
START	Starts firmware updating. Perform the update operation according to the on-screen instructions.

■ Standby

Switches network standby setting.

Network Standby	Switches network standby setting (On/Off/Auto). For details on the settings, see "Network standby" (p.11).
-----------------	--

■ MAC Filter

Sets the MAC addresses to limit the network devices that can access the unit.

Off	Disables the MAC address filter.
On	Enables the MAC address filter. Only the network devices with the MAC addresses specified in "MAC Address 1" to "MAC Address 10" will be able to access the unit.
APPLY	Click to apply the specified settings.
MAC Address 1-10	Specify the MAC addresses of network devices (up to 10) that can access the unit.



- If the MAC address filter is enabled, be sure to specify the MAC address of the PC used for setup. If "APPLY" is clicked without the address specified, this unit will be inaccessible. If this unit becomes inaccessible, reset its network settings (p.32).

■ Licenses

Displays the license information for the software used with this unit.

■ Other Setup

Specifies other settings.

Remote Sensor	Switches on/off reception of the remote control signal. Even when turned off, operations other than with the remote control (such as from the MusicCast CONTROLLER or unit's rear panel) can be performed.
---------------	--

Restoring the default settings

All unit settings or only network settings can be restored.

Restoring the default settings (Factory reset)

- 1 Turn off the unit.**
- 2 While holding down CONNECT on the rear panel, press the ⏻ (power) switch to turn on the unit.**

Restoring the default network settings

The following parameters are returned to their default settings.

- Network connection settings
- All registered presets
- Wireless LAN and Wireless Direct connection log



- 1 Turn off the unit.**
- 2 While holding down WIRELESS DIRECT on the rear panel, press the ⏻ (power) switch to turn on the unit.**

When initialization is finished, the unit is turned on.

Troubleshooting

Refer to the chart below when this unit does not function properly. If the problem you are experiencing is not listed below or if the instruction below does not help, turn off the unit, disconnect the AC power supply cable, and contact the nearest authorized Yamaha dealer or service center.

General

Problem	Cause	Remedy	See page
This unit does not operate properly.	The internal microPC has been frozen by an external electric shock (such as lightning or excessive static electricity) or by a power supply with low voltage.	Disconnect the AC power supply cable from the outlet and plug it again in after 30 seconds.	—
This unit fails to turn on when  (power) is pressed (the STATUS indicator flashes red), or the unit is turned off soon after the power has been turned on.	The AC power supply cable is not firmly connected to the AC wall outlet.	Connect the AC power supply cable firmly to the AC wall outlet.	10
	The internal microPC has been frozen by an external electric shock (such as lightning or excessive static electricity) or by a power supply with low voltage.	Disconnect the AC power supply cable from the outlet and plug it again in after 30 seconds.	—
This unit is suddenly turned off.	The internal temperature becomes too high and the overheat protection circuitry has been activated.	Wait for about 1 hour for this unit to cool down, turn it back on after confirming an adequate amount of ventilation space and not to cover this unit with a cloth.	11
	When the Auto Power Standby function is enabled, this unit turns off automatically in any of the following situations: – Audio is coming from the selected input source. However, no operations have been performed for 8 hours or more. – <i>Bluetooth</i> or NET is selected as the input source, but no audio has been input to the unit or no operations have been performed with the unit for more than 20 minutes.	Turn on the power of the unit and play back the source again. If the Auto Power Standby function is not used, set “Auto Power Standby” to “Off”.	
No sound.	Incorrect input or output cable connections.	Connect the cable properly.	9
	No appropriate input source has been selected.	Select an appropriate input source with the input selector keys.	8
	The volume is turned down.	Turn up the volume.	—
	The sound is muted.	Press  (mute) or +/- (volume) to resume audio output and adjust the volume level.	—
A digital or high-frequency equipment produces noises.	The unit may be placed close to digital equipment or high-frequency equipment.	Move the equipment away from the unit.	—

Bluetooth

Problem	Cause	Remedy	See page
Cannot make the unit paired with the Bluetooth device.	Wireless switch is set to "OFF".	Set it to "AUTO".	7
	The device does not support A2DP.	Perform pairing operations with a device which supports A2DP.	—
	The unit and device are too far apart.	Position the <i>Bluetooth</i> device so that it is less than 10 m (33 ft) from this unit and pair the device with this unit.	—
	There is a device (microwave oven, wireless LAN, etc.) outputs signals in the 2.4 GHz frequency band nearby.	Move this unit away from the device that is emitting radio frequency signals.	—
	Another <i>Bluetooth</i> device is connected.	Disconnect current <i>Bluetooth</i> connection, and perform pairing with the new device.	25
	<i>Bluetooth</i> is not selected as the input source.	Select <i>Bluetooth</i> as the input source.	8
	A <i>Bluetooth</i> adaptor, etc. that you want to pair with the unit has a password other than "0000".	Use a <i>Bluetooth</i> adaptor, etc. whose password is "0000".	24
Cannot make a Bluetooth connection.	Wireless switch is set to "OFF".	Set it to "AUTO".	7
	Another <i>Bluetooth</i> device is connected.	The unit cannot make multiple <i>Bluetooth</i> connections. Disconnect current <i>Bluetooth</i> connection, and make connection for the desired device.	25
	More than 20 devices are paired and the oldest pairing information is deleted.	Perform pairing again. This unit can be paired with a maximum total of 20 <i>Bluetooth</i> devices for reception and transmission. When the 21st device is registered, the least frequently used pairing information is deleted.	24
No sound is produced or the sound is intermittent during playback.	The <i>Bluetooth</i> connection of the unit with the device is disconnected.	Perform <i>Bluetooth</i> connection operations again.	24
	The unit and device are too far apart.	Move the <i>Bluetooth</i> device so that it is less than 10 m (33 ft) from this unit.	—
	There is a device (microwave oven, wireless LAN, etc.) outputs signals in the 2.4 GHz frequency band nearby.	Move this unit away from the device that is emitting radio frequency signals.	—
	The device's <i>Bluetooth</i> function is off.	Enable the <i>Bluetooth</i> function of the device.	—
	The device's volume is set to minimum.	Turn up the volume level on the device.	—

Remote control

Problem	Cause	Remedy	See page
The remote control does not work and/or function properly.	The wrong distance or angle.	The remote control functions within a maximum range of 6 m (20 ft) and no more than 30 degrees off-axis from the front panel.	8
	Direct sunlight or lighting (from an inverter type of fluorescent lamp, etc.) is striking the remote control sensor of this unit.	Reposition this unit.	—
	The batteries are weak.	Replace all batteries.	8

Network

Problem	Cause	Remedy	See page
The network feature does not function.	The network parameters (IP address) have not been obtained properly.	Enable the DHCP server function on your router and set "DHCP" to "On" on the unit. If you want to configure the network parameters manually, check that you are using an IP address which is not used by other network devices in your network.	29
Unable to connect to wireless router (access point).	The wireless router's MAC address filter is enabled.	A connection cannot be established if the wireless router's MAC address filter is enabled. Change the wireless router (access point) settings and try connecting again.	—
Playback stops unexpectedly and files cannot be played continuously.	The folder contains some files that cannot be played via the unit.	Delete or move files (including video or hidden files) that cannot be played via the unit from the folder.	—
The unit does not detect the PC.	The media sharing setting is not correct.	Configure the sharing setting and select the unit as a device to which music contents are shared.	—
	Some security software installed on your PC is blocking the access of the unit to your PC.	Check the settings of security software installed on your PC.	—
	The unit and PC are not in the same network.	Check the network connections and your router settings, and then connect the unit and the PC to the same network.	—
The files in the PC cannot be viewed or played back.	The files are not supported by the unit or the media server.	Use the file format supported by both the unit and the media server.	36
The Internet radio cannot be played.	The selected Internet radio station is currently not available.	There may be a network problem at the radio station, or the service may have been stopped. Try the station later or select another station.	—
	The selected Internet radio station is currently broadcasting silence.	Some Internet radio stations broadcast silence at certain of times of the day. Try the station later or select another station.	—
	Access to the network is restricted by the firewall settings of your network devices (such as the router).	Check the firewall settings of your network devices. The Internet radio can be played only when it passes through the port designated by each radio station. The port number varies depending on the radio station.	—
The dedicated apps for mobile device does not detect the unit.	The unit and mobile device are not in the same network.	Check the network connections and your router settings, and then connect the unit and mobile device to the same network.	—
Firmware update via the network fails.	It may not be possible depending on the condition of the network.	Check that this unit is connected to the network, and try again a few minutes after.	28
The iPod does not recognize the unit when using AirPlay.	The unit is connected to a multiple SSID router.	Access to the unit might be restricted by the network separation function on the router. Connect the iPod to the SSID which can access the unit.	—
The unit cannot connect to the Internet via a wireless router (access point).	The wireless router (access point) is turned off.	Turn on the wireless router (access point).	—
	The unit and the wireless router (access point) are too far apart.	Place the unit and the wireless router (access point) closer to each other.	—
	There is an obstacle between the unit and the wireless router (access point).	Move the unit and the wireless router (access point) in a location where there are no obstacles between them.	—
Wireless network is not found.	There is a device (microwave oven, wireless LAN, etc.) outputs signals in the 2.4 GHz frequency band nearby.	Move this unit away from the device that is emitting radio frequency signals.	—
	Access to the network is restricted by the firewall settings of the wireless router (access point).	Check the firewall setting of the wireless router (access point).	—

Supported devices and file formats

Supported devices

■ DLNA

- PC installed with “Windows Media Player 11” or “Windows Media Player 12”
- DLNA (ver. 1.5) compatible NAS

■ AirPlay

AirPlay works with iPhone, iPad, and iPod touch with iOS 4.3.3 or later, Mac with OS X Mountain Lion or later, and Mac and PC with iTunes 10.2.2 or later.
(as of August 2015)

■ Bluetooth

- The unit supports A2DP.

■ USB DAC

The unit supports following operating systems.

- Windows 7 (32/64bit)
- Windows 8 (32/64bit)
- Mac OS X 10.6.4 or later



- Operations may be disabled even with the above-mentioned operating systems, depending on the configuration or environment of the PC.

File formats

■ DLNA

Format	Sampling frequency (kHz)	Quantization bitrate (bit)
WAV		
AIFF	Up to 192kHz	16/24
FLAC		
ALAC	Up to 96kHz	16/24
MP3		
WMA	Up to 48kHz	16
AAC		
DSD	2.8MHz/5.6MHz	

■ USB DAC

Format	Sampling frequency (kHz)	Quantization bitrate (bit)
PCM	44.1kHz/48kHz/88.2kHz/96kHz/ 176.4kHz/192kHz/352.8kHz/ 384kHz	16/24/32
DSD	2.8MHz/5.6MHz/11.2MHz	

■ OPTICAL

Format	Sampling frequency (kHz)	Quantization bitrate (bit)
S/PDIF	32kHz/44.1kHz/48kHz/64kHz/ 88.2kHz/96kHz/176.4kHz/192kHz	16/24

Specifications

Input

- Network
100BASE-TX/10BASE-T x 1
- Digital inputs
USB (USB 2.0 Type B) x 1
OPTICAL x 1
- Analog input
Stereo mini (AUX IN) x 1

Network

- Wi-Fi function
 - Wireless network standard: IEEE 802.11 b/g/n
 - Radio frequency band: 2.4GHz
 - Available security method: WEP, WPA2-PSK (AES), Mixed Mode
 - Capable of WPS by PIN method and push-button-method
 - Capable of sharing with iOS devices by wireless connection
 - Capable of direct connection with mobile device

Bluetooth

- *Bluetooth* version Ver2.1+EDR
- Supported profile A2DP
- Supported codec SBC, AAC
- Wireless output *Bluetooth* Class 2
- Maximum communication distance
..... 10m (33 ft) without interference

Speaker

- Frequency range (-10 dB) 54 Hz to 40 kHz
- Components
LF 5" cone
HF 1" dome
- Crossover 2 kHz

Amplifier

- Minimum RMS output power
(LF 1 kHz 0.01% THD, 4Ω) 24 W
(HF 20 kHz 0.02% THD, 6Ω) 20 W
[Asia model]
(LF 1 kHz 0.01% THD, 4Ω) 20 W
(HF 20 kHz 0.02% THD, 6Ω) 16 W
- Dynamic power per channel
(Total) 75 W
(LF 1 kHz 10% THD, 4Ω) 45 W
(HF 20 kHz 10% THD, 6Ω) 30 W
[Asia model]
(Total) 65 W
(LF 1 kHz 10% THD, 4Ω) 40 W
(HF 20 kHz 10% THD, 6Ω) 25 W
- Input sensitivity / input impedance
AUX IN 615 mV (-2 dBu) / 25 kΩ
- Maximum input signal
AUX IN 2.4 V
- Signal to noise ratio (IHF-A Network)
(LF 1 kHz 0 dBFS FS44.1 kHz) 100 dB or higher
(HF 20 kHz 0 dBFS FS44.1 kHz) 100 dB or higher
- Dynamic range
(LF 1 kHz 0 dBFS FS44.1 kHz) 100 dB or higher
(HF 20 kHz 0 dBFS FS44.1 kHz) 100 dB or higher
- Residual noise (IHF-A Network) 40 μV
- Tone control characteristics*
BASS (boost/cut) ±10 dB, 100 Hz
TREBLE (boost/cut) ±10 dB, 20 kHz

General

- Power supply
[U.S.A. and Canada models] AC 120 V, 60 Hz
[China model] AC 220 V, 50 Hz
[Korea model] AC 220 V, 60 Hz
[Australia model] AC 240 V, 50 Hz
[U.K. and Europe models] AC 230 V, 50 Hz
[Asia model] AC 220-240 V, 50/60 Hz
[Taiwan model] AC 110 V, 60 Hz
- Power consumption 45 W + 45 W
- Standby power consumption
Eco Standby 0.2 W
Network Standby (Wired) 1.8 W
Network Standby (Wi-Fi/Wireless Direct) 2.0 W/2.0 W
- Dimensions (W x H x D)
Left 170 x 285 x 238.6 mm (6-11/16" x 11-1/4" x 9-3/8")
Right 170 x 285 x 232 mm (6-11/16" x 11-1/4" x 9-1/8")
- Weight
Left 6.2 kg (13.8 lbs)
Right 5.7 kg (12.6 lbs)

*Tone Control can be operated from MusicCast CONTROLLER app only.

Specifications are subject to change without notice.

Trademarks

AirPlay, iPhone, iPod, iPod nano, iPod touch and iTunes are trademarks of Apple Inc., registered in the U.S. and other countries.



DLNA™ and DLNA CERTIFIED™ are trademarks or registered trademarks of Digital Living Network Alliance. All rights reserved. Unauthorized use is strictly prohibited.

Windows™

Windows is a registered trademark of Microsoft Corporation in the United States and other countries.

Internet Explorer, Windows Media Audio and Windows Media Player are either registered trademarks or trademarks of Microsoft Corporation in the United States and/or other countries.

Android™

Android and Google Play are trademarks of Google, Inc.



The Wi-Fi CERTIFIED Logo is a certification mark of the Wi-Fi Alliance.

The Wi-Fi Protected Setup Identifier Mark is a mark of the Wi-Fi Alliance.

Wi-Fi, Wi-Fi Alliance, Wi-Fi CERTIFIED, Wi-Fi Protected Setup, WPA and WPA2 are trademark or registered trademark of Wi-Fi Alliance.



The *Bluetooth*® word mark and logos are registered trademarks owned by Bluetooth SIG, Inc. and any use of such marks by Yamaha Corporation is under license.

Bluetooth protocol stack (Blue SDK)

Copyright 1999-2014 OpenSynergy GmbH

All rights reserved. All unpublished rights reserved.

Explanations regarding GPL





























This product utilizes GPL/LGPL open-source software in some sections. You have the right to obtain, duplicate, modify, and redistribute this open-source code only. For information on GPL/LGPL open source software, how to obtain it, and the GPL/LGPL license, refer to the Yamaha Corporation website (<http://download.yamaha.com/sourcecodes/musiccast/>).











MusicCast is a trademark or registered trademark of Yamaha Corporation.

Table of status indicator conditions













Indications during playback

Color	Condition		Status	See page
● Green	Lit		The network input is selected.	p.18, 20, 21
	Flashing		A network connection is being set up.	p.12
	Slow flashing	 1 second →  1 second → 	No connection is established with the network.	p.12
	Fading every 3 seconds	 3 second →  3 second → 	Audio is being received from the MusicCast CONTROLLER.	p.18, 20, 21
● Pink	Lit		The unit is connected to an iOS device (AirPlay).	p.23
	Slow flashing	 1 second →  1 second → 	The iOS device settings are being shared and a connection has been established wirelessly (Wireless Accessory Configuration).	p.15
● Blue	Lit		The Bluetooth input is selected.	p.24
	Slow flashing	 1 second →  1 second → 	Bluetooth cannot be paired.	
● Sky blue	Lit		The USB input is selected.	p.26
	Slow flashing	 1 second →  1 second → 	No PC is connected to the USB jack.	
● Purple	Lit		The optical digital input is selected.	p.27
	Slow flashing	 1 second →  1 second → 	No device is connected to the OPTICAL jack.	
○ White	Lit		The AUX input is selected.	p.27
All colors listed above	Flashing	(example) 	The volume setting is changed.	—
	Fading every 2 seconds	(example)  2 second →  2 second → 	Speaker output is muted.	—

Indications concerning the system

Color	Condition		Status	See page
● Orange	Lit		The unit is in standby mode.	—
● Yellow	Lit		The unit is in network standby mode.	p.11
○ White	Flashing		A new firmware update is available.	p.28
	Slow flashing	 1 second →  1 second → 	The firmware is being updated.	
	Fading every 3 seconds	 3 second →  3 second → 	The firmware has been successfully updated.	

Indications when the error occurred

Color	Condition		Status	See page
● Orange	Slow flashing	 1 second →  1 second → 	Check the connections of the right speaker.	p.9
● Red	Flashes twice	 	No presets have been registered.	p.22
	Slow flashing	 1 second →  1 second → 	The AC power supply cable is not firmly connected to the AC wall outlet. Connect the AC power supply cable firmly to the AC wall outlet.	p.10
		Repeatedly flashes twice	  1 second →	The protection circuitry has been activated. Turn off the unit, disconnect the AC power supply cable, and contact the nearest authorized Yamaha dealer or service center.
	Repeated flashes three times	   1 second →	The firmware download cannot be found. Check that this unit is connected to the network.	p.28
		An error occurred during firmware updating. To restart updating, press WIRELESS DIRECT on the rear panel.		

Important Notice: Guarantee Information for customers in EEA* and Switzerland**English**

For detailed guarantee information about this Yamaha product, and Pan-EEA* and Switzerland warranty service, please either visit the website address below (Printable file is available at our website) or contact the Yamaha representative office for your country. * EEA: European Economic Area

<http://europe.yamaha.com/warranty/>

Yamaha Global Site
<http://www.yamaha.com/>

Yamaha Downloads
<http://download.yamaha.com/>

Manual Development Group
© 2015 Yamaha Corporation

Published 07/2017 KS-C0
Printed in Indonesia

ZZ63590