



UAB

Front Surround System

YAS-203

(YAS-CU203+NS-WSW41)

Owner's Manual



Contents

Supplied items	2
Features	3
Frequently asked questions.....	3
Part names and functions (sound bar/subwoofer)	4
Installation.....	5
Connections.....	6
Operations	8
Listening to the sound from a <i>Bluetooth</i> device.....	10
Settings	12
Programming the sound bar with the TV's remote control (TV's remote control learning function).....	12
Sending the TV's remote signal through the sound bar (TV Remote Repeater function).....	14
Setting the auto power standby function	14
Initializing the sound bar	14
Troubleshooting	15
Specifications	20

About this manual

NOTE

This indicates precautions for use of the product and its feature limitations.

HINT

This indicates supplementary explanations for better use.

IMPORTANT SAFETY INSTRUCTIONS



CAUTION

**RISK OF
ELECTRIC
SHOCK DO
NOT OPEN**



CAUTION: TO REDUCE THE RISK OF ELECTRIC SHOCK, DO NOT REMOVE COVER (OR BACK). NO USER-SERVICEABLE PARTS INSIDE. REFER SERVICING TO QUALIFIED SERVICE PERSONNEL.

Explanation of Graphical Symbols

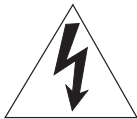

The lightning flash with arrowhead symbol, within an equilateral triangle, is intended to alert you to the presence of uninsulated "dangerous voltage" within the product's enclosure that may be of sufficient magnitude to constitute a risk of electric shock to persons.



The exclamation point within an equilateral triangle is intended to alert you to the presence of important operating and maintenance (servicing) instructions in the literature accompanying the appliance.

IMPORTANT

Please record the serial number of this unit in the space below.

MODEL:

Serial No.:

The serial number is located on the rear of the unit. Retain this Owner's Manual in a safe place for future reference.

FOR CANADIAN CUSTOMERS

To prevent electric shock, match wide blade of plug to wide slot and fully insert.
CAN ICES-3 (B)/NMB-3 (B)

- 1 Read these instructions.
- 2 Keep these instructions.
- 3 Heed all warnings.
- 4 Follow all instructions.
- 5 Do not use this apparatus near water.
- 6 Clean only with dry cloth.
- 7 Do not block any ventilation openings. Install in accordance with the manufacturer's instructions.
- 8 Do not install near any heat sources such as radiators, heat registers, stoves, or other apparatus (including amplifiers) that produce heat.
- 9 Do not defeat the safety purpose of the polarized or grounding-type plug. A polarized plug has two blades with one wider than the other. A grounding type plug has two blades and a third grounding prong. The wide blade or the third prong are provided for your safety. If the provided plug does not fit into your outlet, consult an electrician for replacement of the obsolete outlet.
- 10 Protect the power cord from being walked on or pinched particularly at plugs, convenience receptacles, and the point where they exit from the apparatus.
- 11 Only use attachments/accessories specified by the manufacturer.
- 12 Use only with the cart, stand, tripod, bracket, or table specified by the manufacturer, or sold with the apparatus. When a cart is used, use caution when moving the cart/apparatus combination to avoid injury from tip-over.
- 13 Unplug this apparatus during lightning storms or when unused for long periods of time.
- 14 Refer all servicing to qualified service personnel. Servicing is required when the apparatus has been damaged in any way, such as power-supply cord or plug is damaged, liquid has been spilled or objects have fallen into the apparatus, the apparatus has been exposed to rain or moisture, does not operate normally, or has been dropped.



We Want You Listening For A Lifetime



Yamaha and the Electronic Industries Association's Consumer Electronics Group want you to get the most out of your equipment by playing it at a safe level. One that lets the sound come through loud and clear without annoying blaring or distortion – and, most importantly, without affecting

your sensitive hearing. Since hearing damage from loud sounds is often undetectable until it is too late, Yamaha and the Electronic Industries Association's Consumer Electronics Group recommend you to avoid prolonged exposure from excessive volume levels.

FCC INFORMATION (for US customers)

- 1 **IMPORTANT NOTICE: DO NOT MODIFY THIS UNIT!** This product, when installed as indicated in the instructions contained in this manual, meets FCC requirements. Modifications not expressly approved by Yamaha may void your authority, granted by the FCC, to use the product.
- 2 **IMPORTANT:** When connecting this product to accessories and/or another product use only high quality shielded cables. Cable/s supplied with this product MUST be used. Follow all installation instructions. Failure to follow instructions could void your FCC authorization to use this product in the USA.
- 3 **NOTE:** This product has been tested and found to comply with the requirements listed in FCC Regulations, Part 15 for Class "B" digital devices. Compliance with these requirements provides a reasonable level of assurance that your use of this product in a residential environment will not result in harmful interference with other electronic devices. This equipment generates/uses radio frequencies and, if not installed and used according to the instructions found in the users manual, may cause interference harmful to the operation of other electronic devices.
- 4 Compliance with FCC regulations does not guarantee that interference will not occur in all installations. If this product is found to be the source of interference, which can be determined by turning the unit "OFF" and "ON", please try to eliminate the problem by using one of the following measures:
- 5 Relocate either this product or the device that is being affected by the interference.
- 6 Utilize power outlets that are on different branch (circuit breaker or fuse) circuits or install AC line filter/s.
- 7 In the case of radio or TV interference, relocate/reorient the antenna. If the antenna lead-in is 300 ohm ribbon lead, change the lead-in to coaxial type cable.
- 8 If these corrective measures do not produce satisfactory results, please contact the local retailer authorized to distribute this type of product. If you can not locate the appropriate retailer, please contact Yamaha Corporation of America A/V Division 6600 Orangethorpe Ave., Buena Park, CA 90620.
- 9 The above statements apply ONLY to those products distributed by Yamaha Corporation of America or its subsidiaries.

- This device complies with Part 15 of the FCC Rules and RSSGen of IC Rules.
 - Operation is subject to the following two conditions: 1) this device may not cause harmful interference, and 2) this device must accept any interference received including interference that may cause undesired operation.
- See the "Troubleshooting" section at the end of this manual if interference to radio reception is suspected.

FCC WARNING

Change or modifications not expressly approved by the party responsible for compliance could void the user's authority to operate the equipment.

NOTICE

This equipment has been tested and found to comply with the limits for a Class B digital device, pursuant to part 15 of the FCC Rules. These limits are designed to provide reasonable protection against harmful interference in residential installation. This equipment generates, uses and can radiate radio frequency energy and, if not installed and used in accordance with the instructions, may cause harmful interference to radio communications. However, there is no guarantee that interference will not occur in a particular installation. If this equipment does cause harmful interference to radio or television reception, which can be determined by turning the equipment off and on, the user is encouraged to try to correct the interference by one or more of the following measures:

- Reorient or relocate the receiving antenna.
- Increase the separation between the equipment and receiver.
- Connect the equipment into an outlet on a circuit different from that to which the receiver is connected.
- Consult the dealer or an experienced radio/TV technician for help.

This equipment complies with FCC/IC radiation exposure limits set forth for uncontrolled equipment and meets the FCC radio frequency (RF) Exposure Guidelines and RSS-102 of the IC radio frequency (RF) Exposure rules. This equipment has very low levels of RF energy that it deemed to comply without maximum permissive exposure evaluation (MPE). But it is desirable that it should be installed and operated with at least 20 cm and more between the radiator and person's body.

This transmitter must not be co-located or operated in conjunction with any other antenna or transmitter.

CAUTION: READ THIS BEFORE OPERATING YOUR UNIT.

- To assure the finest performance, please read this manual carefully. Keep it in a safe place for future reference.
- Install this unit in a well ventilated, cool, dry, clean place - away from direct sunlight, heat sources, vibration, dust, moisture, and/or cold. For proper ventilation, allow the following minimum clearances.
Sound bar: Top: 10 cm (4 in), Rear: 10 cm (4 in), Sides: 10 cm (4 in)
Subwoofer: Top: 20 cm (8 in), Rear: 20 cm (8 in), Sides: 20 cm (8 in)
- Locate this unit away from other electrical appliances, motors, or transformers to avoid humming sounds.
- Do not expose this unit to sudden temperature changes from cold to hot, and do not locate this unit in an environment with high humidity (i.e. a room with a humidifier) to prevent condensation inside this unit, which may cause an electrical shock, fire, damage to this unit, and/or personal injury.
- Avoid installing this unit where foreign objects may fall onto this unit and/or this unit may be exposed to liquid dripping or splashing. On the top of this unit, do not place:
 - Other components, as they may cause damage and/or discoloration on the surface of this unit.
 - Burning objects (i.e. candles), as they may cause fire, damage to this unit, and/or personal injury.
 - Containers with liquid in them, as they may fall and liquid may cause electrical shock to the user and/or damage to this unit.
- Do not cover this unit with a newspaper, tablecloth, curtain, etc., in order not to obstruct heat radiation. If the temperature inside this unit rises, it may cause fire, damage to this unit, and/or personal injury.
- Do not plug in this unit to a wall outlet until all connections are complete.
- Do not operate this unit upside-down. It may overheat, possibly causing damage.
- Do not use force on switches, knobs and/or cords.
- When disconnecting the power cable from the wall outlet, grasp the plug; do not pull the cable.
- Do not clean this unit with chemical solvents; this might damage the finish. Use a clean, dry cloth.
- Only voltage specified on this unit must be used. Using this unit with a higher voltage than specified is dangerous and may cause fire, damage to this

- unit, and/or personal injury. Yamaha will not be held responsible for any damage resulting from use of this unit with a voltage other than specified.
- To prevent damage by lightning, keep the power cable and outdoor antennas disconnected from a wall outlet or the unit during a lightning storm.
 - Do not attempt to modify or fix this unit. Contact qualified Yamaha service personnel when any service is needed. The cabinet should never be opened for any reasons.
 - When not planning to use this unit for long periods of time (i.e. vacation), disconnect the AC power plug from the wall outlet.
 - Be sure to read the “Troubleshooting” section on common operating errors before concluding that this unit is faulty.
 - Before moving this unit, press  to set this unit in standby mode, and disconnect the power supply cable from the wall outlet.
 - Condensation will form when the surrounding temperature changes suddenly. Disconnect the power supply cable from the outlet, then leave the unit alone.
 - Install this unit near the wall outlet and where the AC power plug can be reached easily.
 - Secure placement or installation is the owner’s responsibility. Yamaha shall not be liable for any accident caused by improper placement or installation of speakers.
 - Do not put a hand or foreign object into the port on the subwoofer.
 - When moving the subwoofer, do not hold the port, as it may cause personal injury and/or damage to this unit.
 - Do not place a fragile object near the port of the subwoofer. If the object falls as a result of the air pressure, it may cause personal injury and/or damage to the subwoofer and the object.
 - Keep the product out of reach of children to avoid them swallowing small parts.

Notes on remote controls and batteries

- Do not spill water or other liquids on the remote control.
- Do not drop the remote control.
- Do not leave or store the remote control in the following places:
 - places of high humidity, such as near a bath

- places of high temperatures, such as near a heater or a stove
 - places of extremely low temperatures
 - dusty places
- Do not expose the remote control sensor of this unit to direct sunlight or lighting such as inverted fluorescent lamps.
 - If the batteries grow old, the effective operation range of the remote control decreases considerably. If this happens, replace the batteries with two new ones as soon as possible.
 - Do not use old batteries together with new ones.
 - Do not use different types of batteries (such as alkaline and manganese batteries) together. Read the packaging carefully as these different types of batteries may have the same shape and color.
 - Exhausted batteries may leak. If the batteries have leaked, dispose of them immediately. Avoid touching the leaked material or letting it come into contact with clothing, etc. Clean the battery compartment thoroughly before installing new batteries.
 - Do not carry batteries in a pocket or purse with metal objects like coins, etc.
 - Do not throw away batteries with general house waste. Dispose of them correctly in accordance with your local regulations.
 - Keep batteries away from children. If a battery is accidentally swallowed, contact your doctor immediately.
 - When not planning to use the remote control for long periods of time, remove the batteries from the remote control.
 - Do not charge or disassemble the supplied batteries.
 - The batteries shall not be exposed to excessive heat such as sunshine, fire or like.

WARNING

TO REDUCE THE RISK OF FIRE OR ELECTRIC SHOCK, DO NOT EXPOSE THIS UNIT TO RAIN OR MOISTURE.

As long as this unit is connected to the AC wall outlet, it is not disconnected from the AC power source even if you turn off this unit by . In this state, this unit is designed to consume a very small quantity of power.

(Power key)

Turns on the power of this unit or sets it to the standby mode.

Do not use this unit within 22 cm (9 inches) of persons with a heart pacemaker implant or defibrillator implant.

Radio waves may affect electro-medical devices. Do not use this unit near medical devices or inside medical facilities.

The name plate is located on the bottom of the unit.

FOR U.K. CUSTOMERS

If the socket outlets in the home are not suitable for the plug supplied with this appliance, it should be cut off and an appropriate 3 pin plug fitted. For details, refer to the instructions described below.

NOTE

The plug severed from the mains lead must be destroyed, as a plug with bared flexible cord is hazardous if engaged in a live socket outlet.

SPECIAL INSTRUCTIONS FOR U.K. MODEL

IMPORTANT

THE WIRES IN THE MAINS LEAD ARE COLOURED IN ACCORDANCE WITH THE FOLLOWING CODE:

Blue: NEUTRAL
Brown: LIVE

As the colours of the wires in the mains lead of this apparatus may not correspond with the coloured markings identifying the terminals in your plug, proceed as follows:

The wire which is coloured BLUE must be connected to the terminal which is marked with the letter N or coloured BLACK. The wire which is coloured BROWN must be connected to the terminal which is marked with the letter L or coloured RED. Making sure that neither core is connected to the earth terminal of the three pin plug.

Supplied items

Make sure you have received all of the following items.

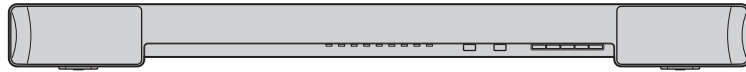

Sound bar (YAS-CU203)



Wireless subwoofer (NS-WSW41)

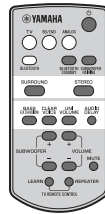

Remote control

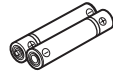

Battery x 2 (AAA, R03, UM4)



Optical cable (1.5 m [4.9 ft])

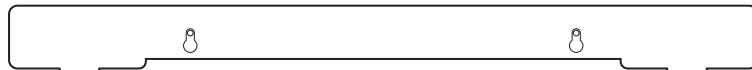

Mounting template

* Using when attaching the sound bar to a wall

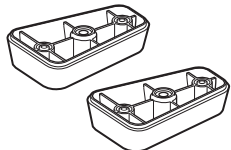

Stand x 2 (For sound bar)



Screw x 2 (For attaching the stand)



Owner's Manual (This manual)

How to use the remote control

Preparing the remote control

Peel off the protection sheet before use.

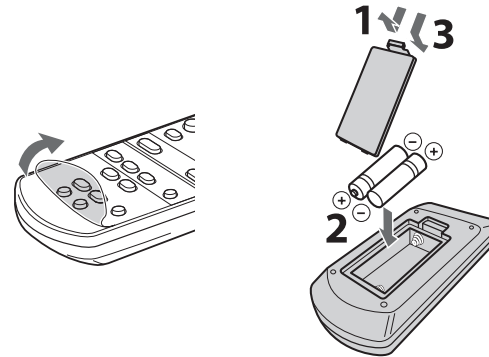

Operating range of the remote control

Remain within the operating range shown below.

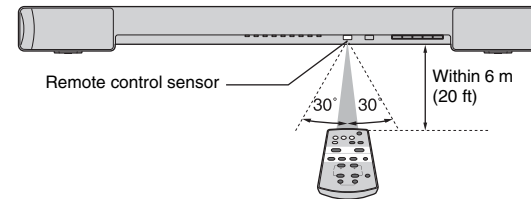

Features

Enjoy powerful and realistic sound from the front surround system consisting of the sound bar and wireless subwoofer, and easy installation and connection to TVs and other devices.

• AIR SURROUND XTREME

Enjoy 7.1 channel surround sound, which creates a wide and deep soundstage, as if speakers are set, not only on the front, but also on the left and right, and behind the listener (p.9).

• Advanced Bass Extension Processing

Equipped with Yamaha's original bass boost technology, this system reproduces more powerful sound from the dedicated subwoofer (p.9).

• Bluetooth® connection Bluetooth®

Content on a *Bluetooth* compatible smartphone, tablet, or computer can be played back easily (p.10).

You can enjoy deep and fresh sound as close to the original by the Compressed Music Enhancer. The sound bar is also compliant with the aptX codec, which enables you to enjoy better sound from your smartphone.

• HOME THEATER CONTROLLER

You can operate the sound bar easily by installing the dedicated controlling application "HOME THEATER CONTROLLER."

• TV's remote control learning function

Operate the sound bar with the TV's remote control (p.12).

• TV Remote Repeater function

Enables the TV's remote signal to pass through the sound bar. If the installed sound bar blocks the TV's remote sensor, the TV's remote will not work. This function provides a convenient solution (p.14).

• Clear voice

Makes voice sound (such as dialogues and narrations) clear (p.9).

• UniVolume

Maintains consistent sound volume when inputs or sound sources switch (p.9).

Frequently asked questions

The following section covers popular functions and frequently asked questions about the sound bar.

Q1 Can I operate the sound bar using the remote control of the TV? Switching between the remote controls of the TV and sound bar is inconvenient.

A1 Yes. You can control the sound bar using your TV's remote control by the "TV's remote control learning" function (p.12).

This function is available only for the IR (infrared) remote control. Check your TV's remote control type.

Q2 The TV's remote control does not work after the sound bar is installed in front of the TV.

A2 If your TV's remote control uses IR (infrared) signals, set the "TV Remote Repeater" function to transmit the TV's remote control signals from the sound bar (p.14).

If your TV's remote control uses radio waves, increase the distance between the TV and sound bar.

Q3 Can I make voice sound more clearly?

A3 Yes. Dialogue in movies, TV news or sports programs, etc., can be made clearer using the "clear voice" function (p.9).

Part names and functions (sound bar/subwoofer)

Sound bar (front panel)

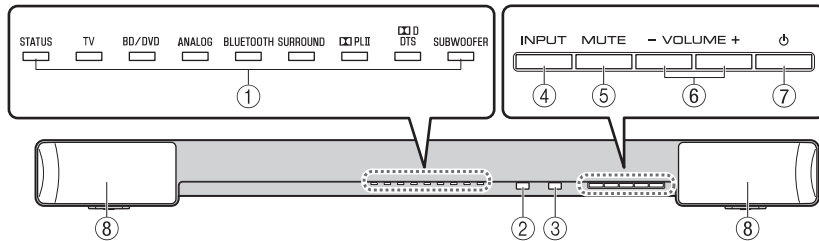

① Indicators

Indicate the status of the sound bar. The indicators will dim automatically if no operations are performed for 5 seconds. Refer to "Operations" (p.8 to 9) and "Wireless connection with the subwoofer" (p.7) for the main functions of the indicators.

② Remote control sensor

Receives infrared signals from the remote control of the sound bar (p.2).

③ TV's remote control sensor

Receives infrared signals from the TV's remote control when the TV Remote Repeater function is enabled (p.14).

④ INPUT key

Selects an input source to be played back (p.8).

⑤ MUTE key

Mutes the audio output. Press the key again to unmute (p.9).

⑥ VOLUME (+/-) keys

Adjust the volume (p.8).

⑦ (power) key

Turns on or off (standby) the sound bar (p.9).

HINT

- The sound bar may automatically turn off when the auto power standby function is enabled (p.14).

⑧ Speakers

Sound bar (rear panel)

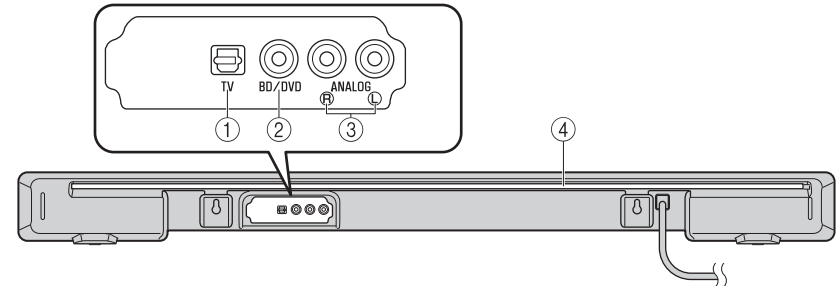

① TV input jack

For connecting to a TV with an optical cable (p.6).

② BD/DVD input jack

For connecting to a playback device, such as a Blu-ray Disc (BD) player, with a coaxial digital cable (p.6).

③ ANALOG input jacks

For connecting an external device with an RCA stereo cable (p.7).

④ IR flasher for TV Remote Repeater

Transmits TV's remote control signals received at the TV's remote control sensor to the TV (p.14).

Subwoofer (rear panel)

① STATUS indicator

Indicates the status of the subwoofer (p.9).

② SUBWOOFER PAIRING button

For setting wireless connection between the sound bar and subwoofer (p.19).

③ Port

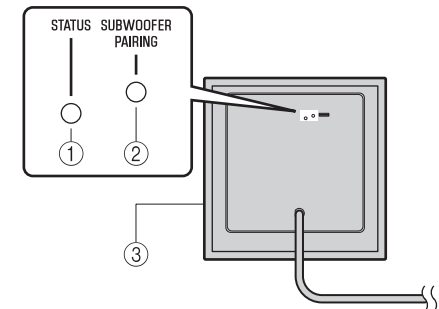

Installation

Place the sound bar on a flat surface such as on top of a TV cabinet.

Place the subwoofer to the outside of the sound bar.

To avoid echoes from the wall, face the front side of the subwoofer slightly inward.

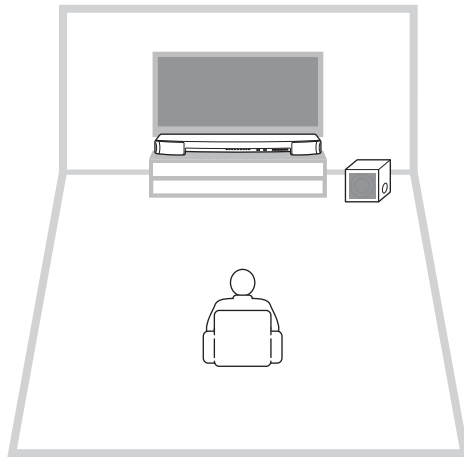

Cautions

- Do not stack the sound bar/subwoofer and a BD player or other device directly on each other. Doing so may cause a malfunction due to vibrations.
- Do not hold the speaker portion (fabric part) on the front of the subwoofer when moving it.
- The sound bar contains non-magnetic shielding speakers. Do not place magnetically sensitive items (hard disk drive, etc.) near the sound bar.
- Depending on your installation environment, it may be better to connect the sound bar and external devices (such as a TV) before installing the sound bar.
- Do not place the sound bar within 50 mm (2") of the TV.
- The subwoofer and sound bar communicate wirelessly. Do not place objects that block wireless signals, such as metallic furniture and devices, between the subwoofer and sound bar as the wireless communication may be adversely affected.
- If the subwoofer is covered with a cloth or other object, the sound volume is reduced. Install the subwoofer so that it is not hidden behind a thick curtain, etc.

HINT

- If it is difficult to operate the TV, use the TV Remote Repeater function (p.14) to transmit the TV's remote control signal via sound bar.
- When placing the sound bar across the bases of the TV, or when changing the height of the sound bar, attach the supplied stands with the stand attachment screws.

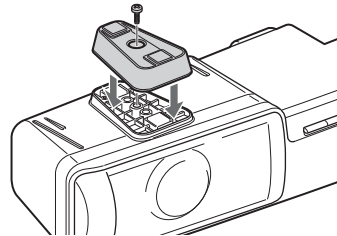

Attaching the sound bar to a wall

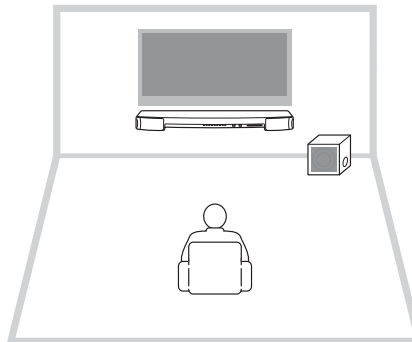

Cautions

- When installing the sound bar on a wall, all installation work must be performed by a qualified contractor or dealer. The customer must never attempt to perform this installation work. Improper or inadequate installation could cause the sound bar to fall, resulting in personal injury.
- Do not attach the sound bar to a wall that is made of weak materials such as plaster or veneered woods. Doing so may cause the sound bar to fall.
- Make sure you use commercially available screws that can support the weight of the installation (specified in Step 2 on the right). Using clamps other than specified screws, such as short screws, nails, and two-sided tape, may cause the sound bar to fall.

How to install on the wall

1 Attach the mounting template on a wall and mark for the screw holes.

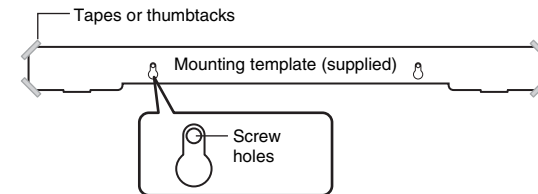

2 Remove the mounting template from the wall, then install commercially available screws (as illustrated below) at the points marked on the wall.

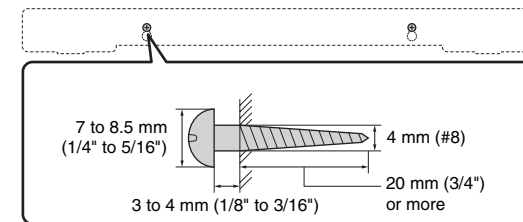

3 Hang the sound bar on the screws.

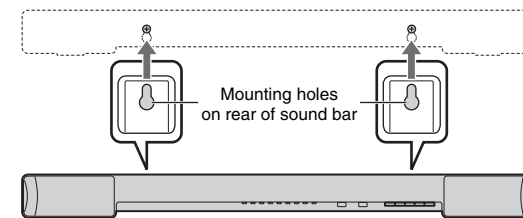

Cautions

- Fix the cables in place where they will not become loose. If your foot or hand accidentally gets caught on a loose cable, the sound bar may fall.
- Check that the sound bar is fixed securely after the installation. Yamaha will bear no responsibility for any accidents caused by improper installations.

Connections

Connect to a TV (or other peripheral device).

Cautions

- Make sure that the power cables of the sound bar and subwoofer are not connected to AC wall outlets when you start making connections.
- Do not use excessive force when inserting the cable plug. Doing so may damage the cable plug or terminal.

1 Connect the TV and sound bar with the optical cable (supplied).

Remove the cap of the optical cable and check the direction of the plug.



2 Connect the power cables of the sound bar and subwoofer to AC wall outlets.

3 Set the TV as follows.

- Set the TV volume to minimum.
- Disable the TV built-in speaker output (if available).

HINT

- If a setting to disable the speaker output is not available on your TV, you may disable it by connecting headphones to the headphone jack on the TV. For details, refer to the manuals of the TV.
- The TV and BD/DVD input jacks support the following audio signals.
 - PCM (2 channel)
 - Dolby Digital (up to 5.1 channel)
 - DTS Digital Surround (up to 5.1 channel)

Sound bar (rear)

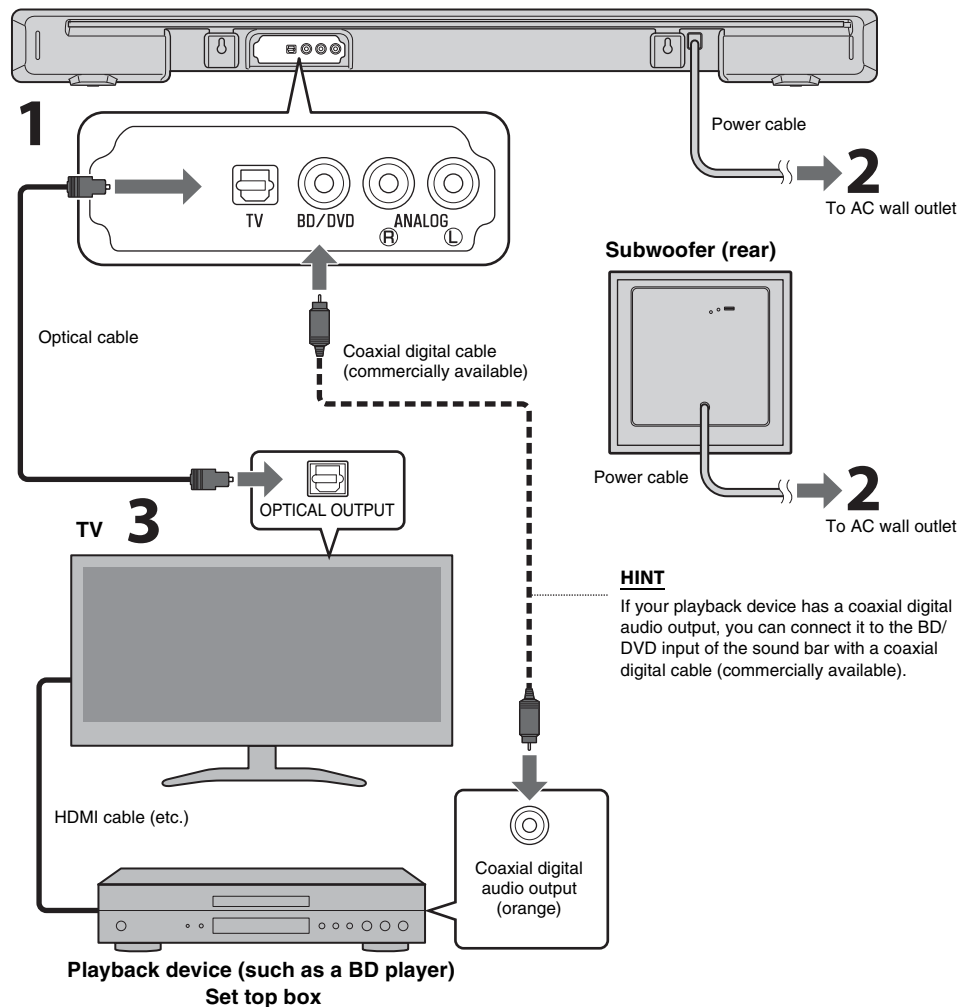

Analog connection of an external device (game console)

You can connect an external device, such as a game console or TV that does not have an optical output, to the ANALOG input jacks of the sound bar.

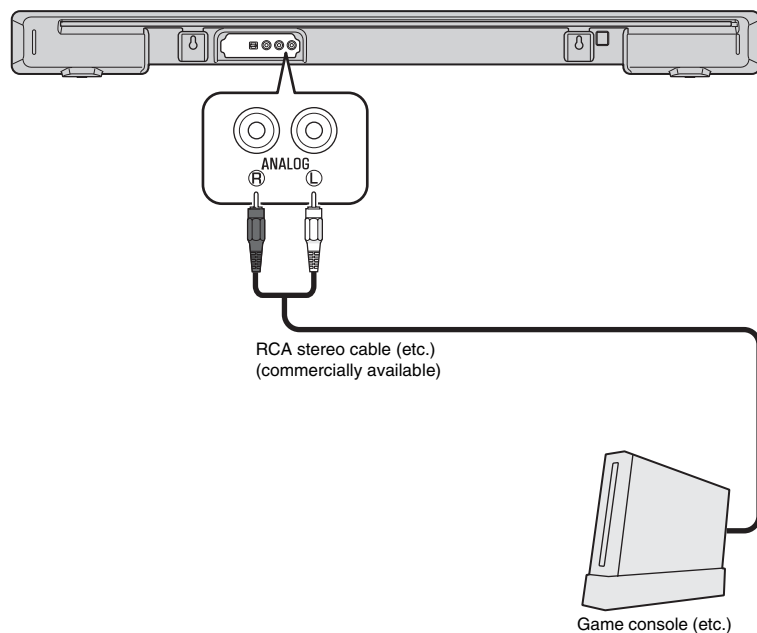

NOTE

- Make sure the left (L) and right (R) channels are connected correctly.
- Select the ANALOG key on the remote control for the input source.

Wireless connection with the subwoofer

When the power cables of the sound bar and subwoofer are connected to AC wall outlets (p.6) and the sound bar is turned on, the sound bar and subwoofer are connected automatically. When the connection is complete, the SUBWOOFER indicator on the sound bar lights up and the sound bar is ready for playback.

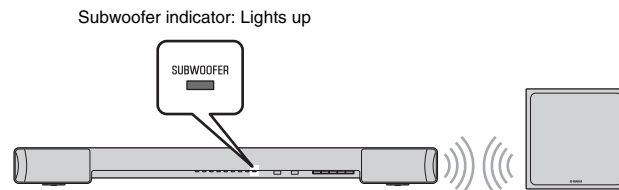

HINT

- When the sound bar is turned on for the first time, if the SUBWOOFER indicator on the sound bar does not light up, see "Pairing the sound bar and subwoofer manually" (p.19) and connect the sound bar and subwoofer manually.
- Once connected, the sound bar operates with the same subwoofer from the next time it is turned on.

Operations

Indicators

The indicators on the front panel flash or light up, to indicate the operation and setting status.

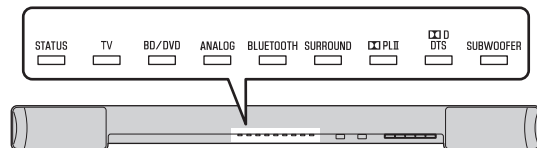

In this manual, illustrations of the nine in-line indicators are used for explanation.

- : Off
- : Lights up
- : Flashes

(Example: When the STATUS indicator flashes and the TV indicator lights up)



1 Input keys

Select an input source to be played back.

- TV** TV audio
- BD/DVD** Audio from a device connected to the BD/DVD input jack
- ANALOG** Audio from a device connected to the ANALOG input jack
- BLUETOOTH**... Audio from a *Bluetooth* connected device

The indicator for the selected input source lights up. (Example: when TV is selected)

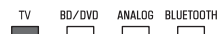

HINT

- To play audio of the playback device connected to the TV or to watch videos of the playback device, set the TV's input source to the playback device.
- For details on *Bluetooth* connection, refer to "Listening to the sound from a *Bluetooth* device" (p.10).

★: Keys that require pressing for more than 3 seconds
 BLUETOOTH STANDBY, SUBWOOFER PAIRING, AUDIO DELAY, LEARN, REPEATER

Remote control signal transmitter

Transmits infrared signals.

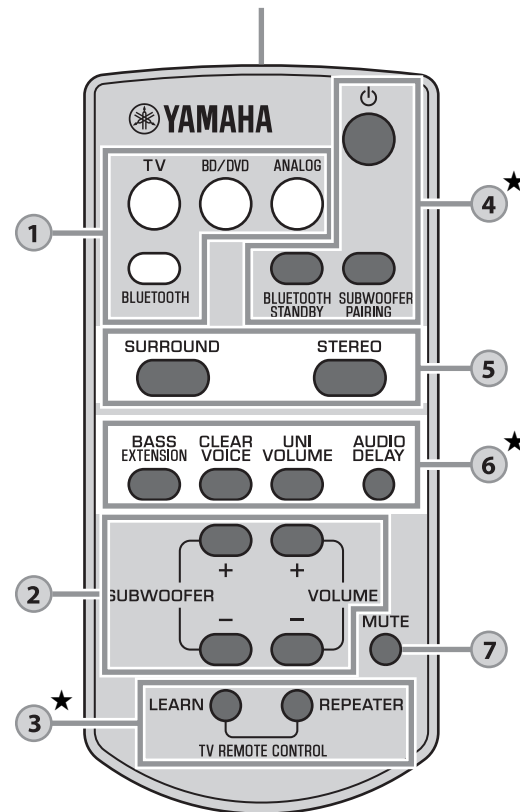

2 SUBWOOFER keys (+/-)

Adjust the volume of the subwoofer.



VOLUME keys (+/-)

Adjust the volume of the sound bar.

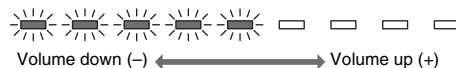

LEARN key★





Sets the sound bar to the TV's remote control learning mode (p.12).

REPEATER key★

Enables/disables the TV Remote Repeater function (p.14).

4**(power) key**

Turns on or off (standby) the sound bar.

The STATUS indicator on the sound barSTATUS  Green (turned on)STATUS  Red (*Bluetooth* standby) (p.11)STATUS  Off (turned off)**The STATUS indicator on the subwoofer** Green (turned on) Red (turned off)**BLUETOOTH STANDBY key★**Enables/disables the *Bluetooth* standby mode (p.11).**SUBWOOFER PAIRING key★**

Performs pairing between the sound bar and subwoofer (p.19).

5**SURROUND and STEREO keys**

Switch between surround and stereo (2 channel) playback. When surround playback is selected, you can enjoy a realistic sound effect using Yamaha's exclusive AIR SURROUND XTREME.

SURROUND  Lights up (surround playback)STEREO  Off (stereo playback)**HINT**

- When 2 channel stereo signals are played in surround, the  PLII indicator lights up.

 Lights up (Dolby Pro Logic II)**CLEAR VOICE key**

Enables/disables the clear voice function. When this function is enabled, you can enjoy clear voice sounds while watching movies, TV dramas, news programs or sports programs.

**UNIVOLUME key**

Enables/disables the UniVolume function. When this function is enabled, consistent volume is maintained when inputs or sound sources switch.

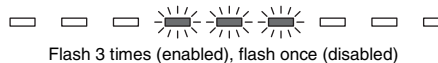
**HINT**

- The UniVolume function is automatically disabled when BLUETOOTH is selected as the input source.

AUDIO DELAY key★

Adjusts the audio delay to synchronize the sound with the video when the video image on the TV may seem delayed with respect to the sound. Follow the procedure below to adjust the audio delay.

1 Hold down the AUDIO DELAY key for more than 3 seconds.

The left most indicator flashes.

**2 Press the SUBWOOFER (+/-) key to adjust the audio delay.**

Pressing the SUBWOOFER (+) key delays the audio output timing.

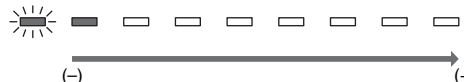
**3 To finish the adjustment, press the AUDIO DELAY key.****HINT**

- The adjustment will be finished automatically if no operations are performed for 20 seconds.

6**BASS EXTENSION key**



Enables/disables the bass extension function. When this function is enabled, you can enjoy powerful sound during surround playback through Yamaha's exclusive bass boost technology.

**7****MUTE key**

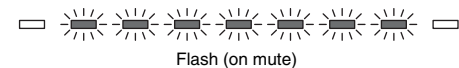
Mutes the audio output. Press the key again to unmute.

**Decoder indication**

The sound bar supports the following audio signals. You can check the type of the input audio signal by the color of the indicator.

 Green (Dolby Digital), Red (DTS Digital Surround) Off (PCM)

Listening to the sound from a *Bluetooth* device

You can play back wirelessly from *Bluetooth* devices, such as smartphones or digital music players.

See also the operating manual of the *Bluetooth* device for more details.

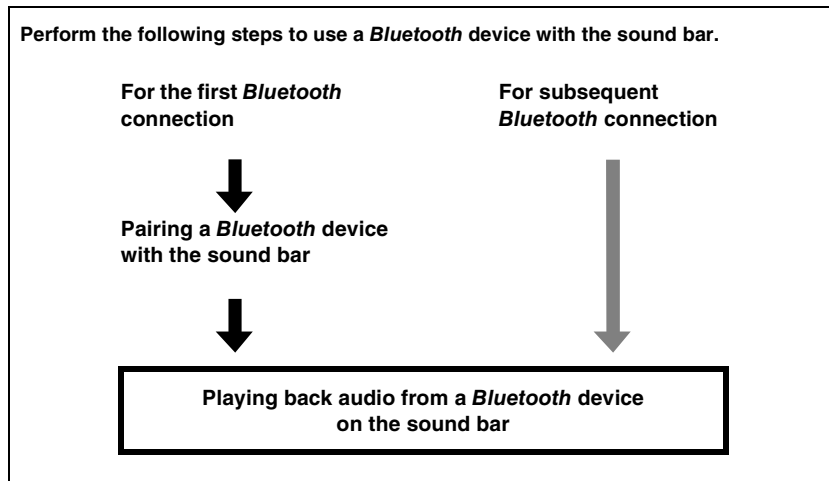
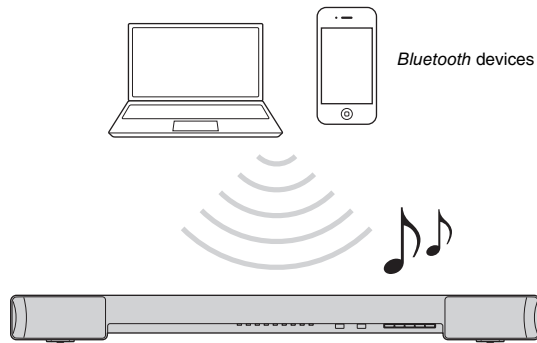

Pairing a *Bluetooth* device with the sound bar

When connecting to a *Bluetooth* device for the first time, “pairing” between the device and sound bar is required. “Pairing” is necessary for each *Bluetooth* device you use. Once “pairing” with a device is completed, subsequent connection with that device will not require “pairing.”

1 Press the **BLUETOOTH** key on the sound bar’s remote control to select *Bluetooth* as the input source.

The **BLUETOOTH** indicator on the front panel lights up in green.





2 Turn on the *Bluetooth* function of the device to be paired, and perform pairing.

The operation varies depending on the device. Refer to the operation manual of the device.

3 Select “YAS-203 Yamaha” in the *Bluetooth* device list on the device.

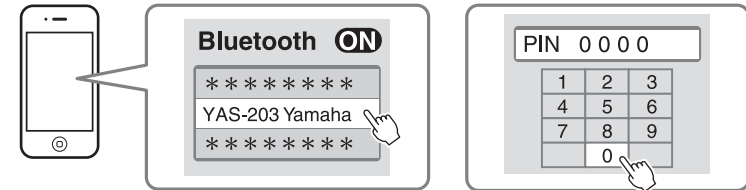
If a passkey (PIN) is required, enter the number “0000.”



When pairing is completed,  or a completion message appears on the device.

NOTE

- Perform pairing with the *Bluetooth* device and sound bar within 10 meters (33 ft) of each other.
- Up to eight *Bluetooth* devices can be paired with the sound bar. If a ninth device is paired, the oldest pairing information is deleted.
- If pairing information for a device is deleted, to use that device again, pairing of the device is required again.
- If a *Bluetooth* device is already connected to the sound bar, terminate that *Bluetooth* connection (p.11), then perform pairing with the new device.
- Refer to “*Bluetooth*” (p.18) in “Troubleshooting” if pairing cannot be achieved.

Playing back audio from a *Bluetooth* device on the sound bar

- 1 With the sound bar turned on, press the **BLUETOOTH** key on the sound bar's remote control to select *Bluetooth* as the input source.

The **BLUETOOTH** indicator on the front panel lights up in green.



- 2 Turn on the *Bluetooth* function of the device.

When *Bluetooth* connection is made correctly, the **BLUETOOTH** indicator of the sound bar flashes 3 times.



- 3 Play back a song on the device.

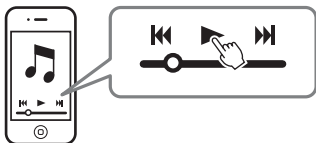

NOTE

- Perform *Bluetooth* connection with the device and sound bar within 10 meters (33 ft) of each other.
- It may be necessary to select "YAS-203 Yamaha" in the *Bluetooth* device list again, in the event that a connection problem occurs. You may have to change the output setting to output audio to the sound bar, depending on the *Bluetooth* device you are using.
- Adjust the volume level of the *Bluetooth* device as required.
- If a *Bluetooth* device is already connected to the sound bar, terminate that *Bluetooth* connection, then connect with the new device.

Terminating *Bluetooth* connection

Bluetooth connection is terminated in the following cases. When the sound bar is turned on and the *Bluetooth* connection is terminated, the **BLUETOOTH** indicator flashes once.

- The *Bluetooth* function is turned off on the compatible device.
- The **BLUETOOTH** key on the sound bar's remote control is pressed for more than 3 seconds.
- The sound bar is turned off.

Using the *Bluetooth* standby mode

The *Bluetooth* standby mode allows you to turn on (or off) the sound bar automatically, that interlocked by the operation of the *Bluetooth* device.

- 1 With the sound bar turned on, hold down the **BLUETOOTH STANDBY** key on the sound bar's remote control for more than 3 seconds.

Holding down the **BLUETOOTH STANDBY** key for 3 seconds each time toggles the mode between enabled and disabled.

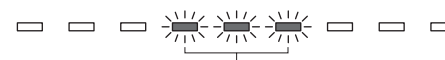

Flash 3 times (enabled), flash once (disabled)

When the *Bluetooth* standby mode is enabled and the sound bar is turned off, the **STATUS** indicator lights up in red. (***Bluetooth* standby**)



Lights up (red)

Functions available on *Bluetooth* devices with *Bluetooth* standby mode enabled

Power on interlock function (when the sound bar is turned off)

When *Bluetooth* connection is made on the device, the sound bar will turn on and will be ready to play back sound from the device.

Power off interlock function (when the sound bar is turned on)

The sound bar will be turned off when *Bluetooth* connection is terminated on a *Bluetooth* device. (Only when **BLUETOOTH** is selected as the input source.)

Using the HOME THEATER CONTROLLER application

By installing the dedicated free application "HOME THEATER CONTROLLER" to a *Bluetooth* device, such as a smartphone, you can perform various operations easily and conveniently with the *Bluetooth* device.

(Setting items: basic operation, sound-field, sound adjustments)

For details on "HOME THEATER CONTROLLER," see the product information on our website.

Settings

Programming the sound bar with the TV's remote control (TV's remote control learning function)

Once you program the sound bar, you can control it with your TV's remote control for functions such as turning on/off the TV and sound bar simultaneously, or volume up/down and muting/unmuting of the sound bar.

- This function is available only when your TV's remote control uses IR (infrared) signal.
- An RF (Radio Frequency) remote control will not work.
- If you want to use a cable or satellite set top box's remote control to operate the sound bar, use your original TV's IR (infrared) remote control to program the sound bar, then use the set top box's remote control to operate.
- If by changing the volume of the sound bar the TV's volume also changes, set the TV's volume to minimum, or disable speaker output.

- 1 Turn off the TV.**
- 2 Turn off the sound bar.**
- 3 Hold down the LEARN key on the sound bar's remote control for more than 3 seconds to set the sound bar to the learning mode.**

When the sound bar is in the learning mode, the indicators on the front panel flash as shown below.

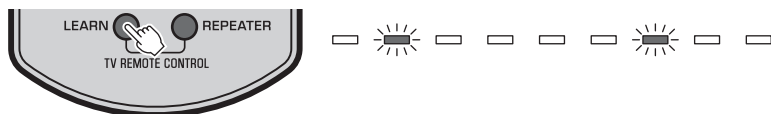

NOTE

- Steps 4 to 7 require only the TV's remote control and the keys on the front panel of the sound bar. The remote control of the sound bar is not necessary.
- If the sound bar has already learned functions, the following indicators light up.
Mute: BD/DVD, Volume (-): ANALOG, Volume (+): BLUETOOTH, Power: SURROUND

- 4 Teach the sound bar the "Mute" code of the TV's remote control.**

- 4-1 Press MUTE on the front panel of the sound bar.**



- 4-2 While pointing your TV's remote control at the remote control sensor, hold down the mute key for more than 1 second twice or three times.**

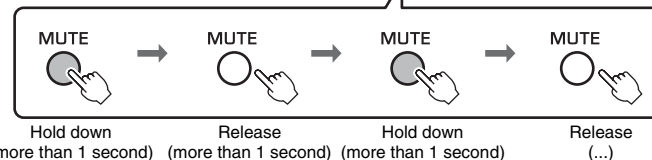
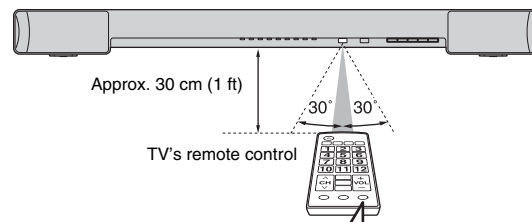

Result	Bleep/buzzer	Indicators
Successfully learned	Once	Lights up
Failed to learn * Repeat from Step 4-1.	Twice	Flash

- 5 Teach the sound bar the "Volume (-)" code of the TV's remote control.**

- 5-1 Press VOLUME (-) on the front panel of the sound bar.**



- 5-2 While pointing your TV's remote control at the remote control sensor, hold down the volume (-) key for more than 1 second twice or three times.**

Result	Bleep/buzzer	Indicators
Successfully learned	Once	Lights up
Failed to learn * Repeat from Step 5-1.	Twice	Flash

6 Teach the sound bar the “Volume (+)” code of the TV’s remote control.

6-1 Press VOLUME (+) on the front panel of the sound bar.



6-2 While pointing your TV’s remote control at the remote control sensor, hold down the volume (+) key for more than 1 second twice or three times.

Result	Bleep/buzzer	Indicators
Successfully learned	Once	Lights up
Failed to learn * Repeat from Step 6-1.	Twice	Flash

7 Teach the sound bar the “Power” code of the TV’s remote control.

7-1 Press (power) on the front panel of the sound bar.



7-2 While pointing your TV’s remote control at the remote control sensor, hold down the power key for more than 1 second twice or three times.

Result	Bleep/buzzer	Indicators
Successfully learned	Once	Lights up
Failed to learn * Repeat from Step 7-1.	Twice	Flash

8 To finish the learning mode, press the LEARN key on the sound bar’s remote control.

This completes the necessary settings. Now you can operate the sound bar with the TV’s remote control’s mute key, volume keys, or power key.

HINT

- The learning mode will be finished automatically if no operations are performed for 5 minutes.
- Set the TV volume to minimum. When you turn up the volume of the sound bar with the TV’s remote control, the volume of the TV may be turned up at the same time. In this case, follow Step 3 in “Connections” (p.6) to change the TV setting.
- You can press the (power) key on the sound bar’s remote control to finish learning mode.

Clearing all programmed functions

1 With the sound bar turned off, hold down the LEARN key on the sound bar’s remote control for more than 3 seconds (for entering the learning mode).

When the sound bar is in the learning mode, the indicators on the front panel flash as shown below.

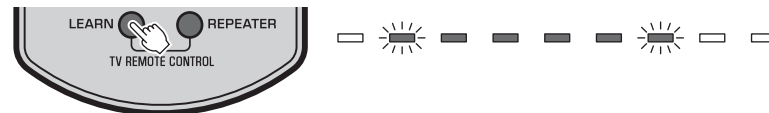

2 Hold down INPUT on the front panel of the sound bar for more than 3 seconds.

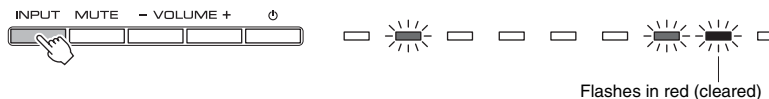

If the clearing is completed, you will hear the bleep sound three times.

3 Press the LEARN key on the sound bar’s remote control.

Sending the TV's remote signal through the sound bar (TV Remote Repeater function)

When the TV Remote Repeater function is enabled, the sound bar relays the TV's remote signal received by the front sensor to the rear transmitter. This function should be enabled when you place the sound bar in front of your TV and you cannot operate your TV with the TV's remote control.

This function is available only when your TV's remote control uses infrared signals.

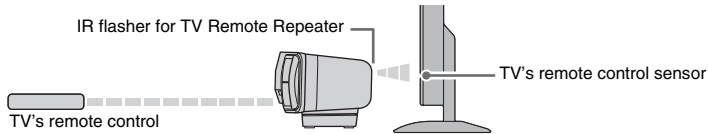

- 1 Turn on the sound bar.
- 2 Hold down the REPEATER key on the sound bar's remote control for more than 3 seconds to enable/disable the TV Remote Repeater function.

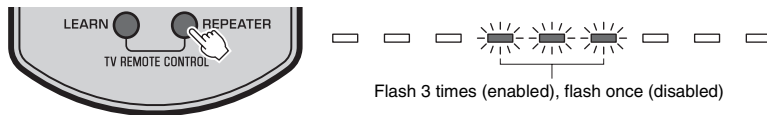

This completes the necessary settings. When the TV Remote Repeater function is enabled, you can operate your TV from the TV's remote control via the sound bar.

HINT

- The TV Remote Repeater function is disabled by default.
- If the power cable of the sound bar is connected to an AC wall outlet and when the TV Remote Repeater function is enabled, the function is usable even when the sound bar is turned off.
- If you have made the sound bar learn the volume (+) operation (p.13), the volume of the TV may be turned up when you turn up the volume of the sound bar with the TV's remote control. In this case, follow Step 3 in "Connections" (p.6) to change the TV setting.
- You can check the status of the TV Remote Repeater function by the SURROUND indicator when turning on the sound bar.

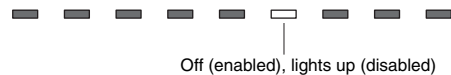

Setting the auto power standby function

By enabling the auto power standby function, you can avoid forgetting to turn off the sound bar after use, or if you fall asleep while watching TV.

NOTE

- When the auto power standby function is enabled and one of the following conditions is met, the sound bar will automatically turn off.
 - No operation for 8 hours
 - No audio input and no operations for 20 minutes when BLUETOOTH is selected as the input source.

- 1 With the sound bar turned off, hold down the MUTE key on the sound bar's remote control for more than 3 seconds to enable/disable the auto power standby function.

You can check the status of the auto power standby function with the TV indicator when turning on the sound bar.

MUTE

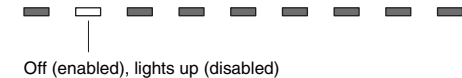

HINT

- Initial setting varies depending on the country or region.
 - U.K. and Europe models: enabled
 - Other models: disabled

Initializing the sound bar

Follow the procedure below to initialize the sound bar.

- 1 Turn off the sound bar.
- 2 Hold down  (power) on the front panel of the sound bar for more than 3 seconds.

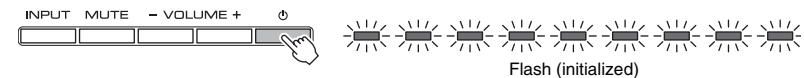

Troubleshooting

Refer to the table below when the sound bar does not function properly. If the problem you are experiencing is not listed below or if the instructions below do not help, turn off the sound bar, disconnect the power cable, and contact the nearest authorized Yamaha dealer or service center.

First, check the following:

- ① **The power cables of the sound bar, subwoofer, TV and playback devices (such as BD players) are connected to AC wall outlets securely.**
- ② **The sound bar, TV and playback devices (such as BD players) are turned on.**
- ③ **The connectors of each cable are securely inserted in to jacks on each device.**

Power and system

Problem	Cause	Remedy
The power turns off suddenly.	The auto power standby function worked. When the auto power standby function is enabled and one of the following conditions is met, the sound bar will automatically turn off. - No operation for 8 hours - No audio input and no operations for 20 minutes when BLUETOOTH is selected as the input source.	Turn on the sound bar again. To stop the sound bar from turning off automatically, disable the auto power standby function (p.14).
	The protection circuitry has been activated. (The STATUS indicator on the front panel of the sound bar flashes.)	After confirming that all connections are made properly, turn on the sound bar again. If the power still turns off suddenly or cannot be turned on, unplug the power cable from the AC wall outlet and contact the nearest authorized Yamaha dealer or service center.
	<i>Bluetooth</i> connection is terminated on a <i>Bluetooth</i> device when the <i>Bluetooth</i> standby mode is enabled.	Disable the <i>Bluetooth</i> standby mode (p.11).
The power cannot be turned on.	The protection circuitry has been activated three times consecutively. (If you try to turn on the power in this condition, the STATUS indicator on the front panel of the sound bar flashes.)	To protect the product, the power cannot be turned on. Unplug the power cable from the AC wall outlet and contact the nearest authorized Yamaha dealer or service center.

The sound bar is not responding correctly.	The internal microcomputer is frozen, due to an external electric shock (such as lightning or excessive static electricity) or to a drop in the power supply voltage.	Hold down (⏻) (power) on the front panel of the sound bar for more than 10 seconds to reboot it. (If the problem persists, disconnect the power cable from the AC wall outlet and plug it again.)
The sound bar operates by itself.	Another <i>Bluetooth</i> device is being operated nearby.	Terminate <i>Bluetooth</i> connection of the sound bar (p.11).
TV's 3D glasses do not work.	The sound bar is blocking the 3D glasses transmitter of your TV.	Check the position of the 3D glasses transmitter of your TV and adjust the position of the sound bar. Remove the stands of the sound bar if they are attached (p.5).

Audio

Problem	Cause	Remedy
No sound.	Another input source is selected.	Select an appropriate input source (p.8).
	The mute function is activated.	Cancel the mute function (p.9).
	The volume is too low.	Turn up the volume (p.8).
	The power cables of the sound bar and subwoofer are not connected properly.	Make sure that power cables of the sound bar and subwoofer are not connected to AC wall outlets securely (p.6).

No sound is coming from the subwoofer. (The SUBWOOFER indicator on the front panel of the sound bar is flashing.)	The subwoofer is not connected to an AC wall outlet. (The STATUS indicator on the subwoofer is not lit.)	Plug in the power cable of the subwoofer to an AC wall outlet.
	The sound bar and subwoofer are not connected due to a bad wireless communication status. (The STATUS indicator on the subwoofer continues to be lit in red or flash in green.)	Move the subwoofer closer to the sound bar. If the situation does not improve, move the subwoofer to a location with better communication.
		If the communication between the sound bar and subwoofer is obstructed by a metallic object or another object, change the position of the sound bar and subwoofer or change the installation location of the subwoofer.
	If there is a device (microwave oven, wireless LAN, etc.) that emits radio frequency signals, move the sound bar and subwoofer away from the device.	
The sound bar and subwoofer are not paired. (The STATUS indicator on the subwoofer is flashing or lit in red.)	Perform the pairing between the sound bar and subwoofer (p.19). If the SUBWOOFER indicator on the sound bar still does not light up in green after the pairing is performed, a malfunction might have occurred. Unplug the power cables from the AC wall outlets and contact the nearest authorized Yamaha dealer or service center.	
	The protection circuitry in the subwoofer has been activated. (The STATUS indicator on the subwoofer is lit in orange.)	To protect the product, the power of the subwoofer cannot be turned on. Unplug the power cable from the AC wall outlet and contact the nearest authorized Yamaha dealer or service center.
The sound from the subwoofer is interrupted. (The SUBWOOFER indicator on the sound bar flashes when the sound is interrupted.)	The connection between the sound bar and subwoofer is interrupted due to a bad wireless communication status. (The STATUS indicator on the subwoofer flashes in green when the sound is interrupted.)	Move the subwoofer closer to the sound bar. If the situation does not improve, move the subwoofer to a location with better communication.
		If the communication between the sound bar and subwoofer is obstructed by a metallic object or another object, change the position of the sound bar and subwoofer or change the installation location of the subwoofer.
		If there is a device (microwave oven, wireless LAN, etc.) that emits radio frequency signals, move the sound bar and subwoofer away from the device.

No sound is coming from the subwoofer or the sound is small. (The SUBWOOFER indicator on the sound bar is lit.)	The volume is too low.	Turn up the volume of the subwoofer (p.8).
	The front side of the subwoofer is blocked.	Clear the area around the front side and the port of the subwoofer.
	The playback source does not contain low-frequency signals.	Play back a sound source containing low-frequency signals, and confirm that the sound is output from the subwoofer.
	The protection circuitry in the subwoofer has been activated. (The STATUS indicator on the subwoofer is lit in orange.)	To protect the product, the power of the subwoofer cannot be turned on. Unplug the power cable from the AC wall outlet and contact the nearest authorized Yamaha dealer or service center.
The volume decreases when the sound bar is turned on.	The automatic volume adjustment function worked. To prevent excessive loudness, the sound bar automatically controls its volume within a certain level when the sound bar is turned on.	If necessary, turn up the volume (p.8).
No surround effect.	Stereo playback is selected.	Select surround playback (p.9).
	The volume is too low.	Turn up the volume (p.8).
	The TV or playback device is set to output 2 channel audio (such as PCM) only.	Change the digital audio output setting on the TV or playback device to Dolby Digital or BitStream.
	The audio is output from the TV built-in speakers.	Set the TV volume to minimum (p.6).
	The playback source does not contain surround audio.	Play back a source that contains audio recorded in surround.
Noise is heard.	The sound bar is too close to another digital or high-frequency device.	Move those devices away from the sound bar.

Remote control

Problem	Cause	Remedy
The sound bar cannot be controlled using the remote control.	The sound bar is out of the operating range.	Use the remote control within the operating range (p.2).
	The batteries are weak.	Replace with new batteries (p.2).
	The remote control sensor of the sound bar is exposed to direct sunlight or strong lighting.	Adjust the lighting angle, or reposition the sound bar.
The TV cannot be controlled using the TV's remote control.	The remote control sensor of the TV is blocked by the sound bar.	Use the TV Remote Repeater function (p.14) or remove the stands of the sound bar if they are attached so that the remote control sensor of the TV is not blocked (p.5).
The TV cannot be controlled by using the TV Remote Repeater function.	The TV Remote Repeater function is disabled.	Enable the TV Remote Repeater function (p.14).
	The TV's remote control does not use infrared signals. (Some remote controls may not work even if it uses infrared signals.)	The TV Remote Repeater function cannot be used in this case. Adjust the position of the sound bar so that the remote control sensor of the TV is not blocked by the sound bar and use the TV's remote control to operate the TV.
	The sound bar and TV are too close or too far from one another.	Move the sound bar away from the TV more than 50 mm (2") (p.5). If necessary, attach or remove the stands of the sound bar to adjust height for the IR flasher (for TV Remote Repeater) of the sound bar positioning in front of the remote control sensor of the TV (p.5).
	There is any obstacle (such as cables) between the sound bar and TV.	Remove the obstacle between the sound bar and TV.
	TV is not receiving the remote control signal well since the signals from the TV's remote control and IR flasher (for TV Remote Repeater) of the sound bar are interfering.	Disable the TV Remote Repeater function (p.14).

The sound bar does not learn TV's remote control operations.	The TV's remote control key was not held down long enough.	Hold down the key for more than 1 second twice or three times (p.12).
	The TV's remote control does not use infrared signals. (Some remote controls may not work even if it uses infrared signals.)	The TV's remote control learning function cannot be used in this case. Use the sound bar's remote control to operate the sound bar.
	The position where you operated the TV's remote control is not appropriate.	Operate the TV's remote control at the appropriate position (p.12).
	The batteries of the TV's remote control are weak.	Replace with new batteries.
	The remote control sensor of the sound bar is exposed to direct sunlight or strong lighting.	Adjust the lighting angle, or reposition the sound bar.
	The transmission of the remote control signal was disturbed by the TV screen light.	Turn off the TV and perform the learning operation again (p.12).
Sound is coming from the TV when the sound bar volume is turned up with the TV's remote control. (when TV's remote control learning function is used)	Audio output is enabled on the TV.	Change the TV setting to disable the TV speaker output. If a setting to disable the speaker output is not available on your TV, try the following methods. - Connect headphones to the headphone jack on the TV. - Set the TV volume to minimum.
The power of the sound bar and of the TV switch in the opposite direction. (For example, the TV is turned off if the sound bar is turned on.) (when TV's remote control learning function is used)	The power of the TV was on when you performed the learning operation.	Press the power key on the TV and  (power) on the front panel of the sound bar to turn them on and then press the power key on the TV's remote control to turn them off.

Bluetooth

Problem	Cause	Remedy
Cannot make the sound bar paired with the Bluetooth device.	<i>Bluetooth</i> is not selected as the input source.	Select <i>Bluetooth</i> as the input source.
	The device does not support A2DP.	Perform pairing operations with a device which supports A2DP.
	A <i>Bluetooth</i> adaptor, etc., that you want to pair with the sound bar has a password other than "0000."	Use a <i>Bluetooth</i> adaptor, etc., whose password is "0000."
	The sound bar and device are too far apart.	Move the device closer to the sound bar.
	There is a device (microwave oven, wireless LAN, etc.) that outputs signals in the 2.4 GHz frequency band nearby.	Move the sound bar away from the device that is emitting radio frequency signals.
	Another <i>Bluetooth</i> device is connected.	Terminate current <i>Bluetooth</i> connection, and perform pairing with the new device.
Cannot make a Bluetooth connection.	Another <i>Bluetooth</i> device is connected.	The sound bar cannot make multiple <i>Bluetooth</i> connections. Terminate current <i>Bluetooth</i> connection, and make connection for the desired device.
	More than nine devices are paired and the oldest pairing information is deleted.	Perform pairing again. The sound bar can retain pairing information for up to eight devices. When pairing a ninth device, the oldest pairing information will be deleted.

No sound is produced or the sound is interrupted during playback.	The <i>Bluetooth</i> connection of the sound bar with the device is disconnected.	Perform <i>Bluetooth</i> connection operations again (p.10).
	<i>Bluetooth</i> is not selected as the input source.	Select <i>Bluetooth</i> as the input source.
	The sound bar and device are too far apart.	Move the device closer to the sound bar.
	There is a device (microwave oven, wireless LAN, etc.) that outputs signals in the 2.4 GHz frequency band nearby.	Move the sound bar and subwoofer away from the device that is emitting radio frequency signals.
	The device is not set to send <i>Bluetooth</i> audio signals to the sound bar.	Change the audio output setting and connection setting on the device.
	Playback on the device has not been performed.	Perform playback on the device.
	The device's volume is set to minimum.	Turn up the volume level.

Pairing the sound bar and subwoofer manually

- 1 With the sound bar turned on, hold down the SUBWOOFER PAIRING key on the sound bar's remote control for more than 3 seconds.**

The SUBWOOFER indicator on the front panel of the sound bar flashes rapidly.



- 2 Within 30 seconds, push the SUBWOOFER PAIRING button on the rear panel of the subwoofer for more than 3 seconds with a tapered object such as a hairpin.**

The STATUS indicator on the rear panel of the subwoofer flashes rapidly in green.

When pairing is complete and the sound bar and subwoofer are connected, the SUBWOOFER indicator on the front panel of the sound bar lights up.

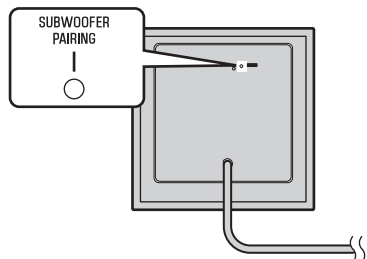

If the SUBWOOFER indicator on the sound bar does not light up even after performing the above operation, see "Troubleshooting" (p.15).

HINT

- "Pairing" is the operation where the sound bar and subwoofer decide the device to connect to.

Specifications

Item		Sound bar (YAS-CU203)	Subwoofer (NS-WSW41)
Amplifier Section	Maximum Rated Output Power	Front L/R 50 W x 2 ch	Dynamic power 100 W
Speaker Section	Type	Acoustic suspension type (Non-magnetic shielding type)	Advanced Yamaha Active Servo Technology (Magnetic shielding type)
	Driver	5.5 cm (2-1/8") cone x 2	16 cm (6-1/2") cone
	Frequency Response	150 Hz to 22 kHz	35 Hz to 150 Hz
	Impedance	6 Ω	5.5 Ω
Decoder	Supported audio signal (TV, BD/DVD)	PCM (2ch) Dolby Digital DTS Digital Surround	--
Input Jacks	Digital (Optical)	1 (TV)	--
	Digital (Coaxial)	1 (BD/DVD)	--
	Analog (RCA)	1 (ANALOG)	--
Wireless subwoofer	Frequency band	2.4 GHz	
	Transmission range	10 m ([33 ft] without interference)	
Bluetooth	Bluetooth version	Ver. 2.1+EDR	--
	Supported protocols	A2DP, SPP	--
	Supported codecs	SBC, aptX	--
	Wireless output	Bluetooth Class 2	
	Maximum communication distance	10 m ([33 ft] without obstructions)	
	Supported content protection method	SCMS-T	

General	Power Supply	U.S.A. and Canada models: AC 120 V, 60 Hz Taiwan model: AC 110-120 V, 50/60 Hz China model: AC 220 V, 50 Hz Other models: AC 220-240 V, 50/60 Hz	U.S.A. and Canada models: AC 120 V, 60 Hz U.K. and Europe models: AC 230 V, 50 Hz Taiwan model: AC 110 V, 60 Hz Korea model: AC 220 V, 60 Hz China model: AC 220 V, 50 Hz Australia model: AC 240 V, 50 Hz Asia model: AC 220-240 V, 50/60 Hz
	Power Consumption	26 W	45 W
	Standby Power Consumption	0.4 W	U.S.A. and Canada models: 1.4 W U.K. and Europe models: 1.5 W Korea and Taiwan models: 1.2 W China model: 1.3 W Australia and Asia models: 1.7 W
	Bluetooth standby power consumption	0.5 W	--
	Dimensions (W x H x D)	886 x 79 x 121 mm (not including stands, default state) (34-7/8" x 3-1/8" x 4-3/4")	290 x 292 x 316 mm (11-3/8" x 11-1/2" x 12-1/2")
		886 x 94 x 121 mm (including stands) (34-7/8" x 3-5/8" x 4-3/4")	
	Thickness excluding speaker protrusions (thinnest part)	65 mm (2-1/2")	--
	Weight	2.9 kg (6.4 lbs)	8.1 kg (17.9 lbs)

* Specifications are subject to change without notice.



This system is equipped with Yamaha's AIR SURROUND XTREME virtual sound technology that achieves superior positional, high-grade 7.1 channel surround sound using the sound bar and subwoofer.



The subwoofer of this system employs Yamaha's exclusive bass control technology "Advanced Yamaha Active Servo Technology II" and has achieved high-quality low-frequency sound playback.



"UniVolume" is a trademark of Yamaha Corporation.



Bluetooth is a registered trademark of the Bluetooth SIG and is used by Yamaha in accordance with a license agreement.



Manufactured under license from Dolby Laboratories. Dolby, Pro Logic and the double-D symbol are trademarks of Dolby Laboratories.



For DTS patents, see <http://patents.dts.com>. Manufactured under license from DTS Licensing Limited. DTS, the Symbol, & DTS and the Symbol together are registered trademarks, and DTS Digital Surround is a trademark of DTS, Inc. © DTS, Inc. All Rights Reserved.



© 2013 CSR plc and its group companies. The aptX® mark and the aptX logo are trade marks of CSR plc or one of its group companies and may be registered in one or more jurisdictions.

"Blu-ray Disc™", "Blu-ray™", and the logos are trademarks of the Blu-ray Disc Association.

Bluetooth

- *Bluetooth* is a technology for wireless communication between devices within an area of about 10 meters (33 ft) employing the 2.4 GHz frequency band, a band which can be used without a license.

Handling Bluetooth communications

- The 2.4 GHz band used by *Bluetooth* compatible devices is a radio band shared by many types of equipment. While *Bluetooth* compatible devices use a technology minimizing the influence of other components using the same radio band, such influence may reduce the speed or distance of communications and in some cases interrupt communications.
- The speed of signal transfer and the distance at which communications is possible differs according to the distance between the communicating devices, the presence of obstacles, radio wave conditions and type of equipment.
- Yamaha does not guarantee all wireless connections between this unit and devices compatible with *Bluetooth* function.

Information for Users on Collection and Disposal of Old Equipment and Used Batteries



These symbols on the products, packaging, and/or accompanying documents mean that used electrical and electronic products and batteries should not be mixed with general household waste. For proper treatment, recovery and recycling of old products and used batteries, please take them to applicable collection points, in accordance with your national legislation and the Directives 2002/96/EC and 2006/66/EC.

By disposing of these products and batteries correctly, you will help to save valuable resources and prevent any potential negative effects on human health and the environment which could otherwise arise from inappropriate waste handling.



For more information about collection and recycling of old products and batteries, please contact your local municipality, your waste disposal service or the point of sale where you purchased the items.

[Information on Disposal in other Countries outside the European Union]

These symbols are only valid in the European Union. If you wish to discard these items, please contact your local authorities or dealer and ask for the correct method of disposal.

Note for the battery symbol (bottom two symbol examples):

This symbol might be used in combination with a chemical symbol. In this case it complies with the requirement set by the Directive for the chemical involved.



Pb

We, Yamaha Music Europe GmbH hereby declare that this unit is in compliance with the essential requirements and other relevant provisions of Directive 1999/5/EC.



Yamaha Music Europe GmbH

Siemensstr. 22-34 25462 Rellingen, Germany
Tel: +49-4101-303-0

Important Notice: Guarantee Information for customers in EEA* and Switzerland

English

For detailed guarantee information about this Yamaha product, and Pan-EEA* and Switzerland warranty service, please either visit the website address below (Printable file is available at our website) or contact the Yamaha representative office for your country.

* EEA: European Economic Area

<http://europe.yamaha.com/warranty/>

