



RX-V767

AV Receiver

Owner's Manual

**English for Asia*, Africa, Oceania
and Latin America**

CONTENTS

INTRODUCTION

Features and capabilities	4
Using the TV OSD to operate the unit	5
View or modify content for the current input source <Content window>	5
Configuring settings for this unit <ON SCREEN menu>.....	5
Adjust settings for each input source <OPTION menu>	6
About this manual.....	7
Supplied accessories.....	7
Part names and functions	8
Front panel.....	8
Rear panel.....	9
Front panel display	10
Remote control	11
On-screen display	12

CONNECTIONS

Connecting speakers	13
Speaker channels and functions.....	13
Speaker layout	14
Connecting speakers and subwoofer	17
Connecting external components	20
Cable plugs and jacks	20
Connecting a TV monitor.....	21
Connecting BD/DVD players and other devices	24
Connecting game consoles	28
Connecting a multi-format player or an external decoder	28
Connecting an external amplifier	29
Connecting a SCENE link playback-compatible device	29
Using the Trigger function to link external component power.....	30
Connecting audio/video recording devices.....	30

Connecting the FM/AM antennas	31
Setting up the speaker parameters automatically (YPAO)	32

PLAYBACK

Basic playback procedure	40
Adjusting high/low-frequency sound (Tone control)	41
Changing input settings with a single key (SCENE function)	42
Registering input sources/sound program/ HDMI OUT	42
Enjoying the desired sound field effect	42
Selecting sound programs and sound decoders.....	42
Sound programs.....	46
Using the TV display to control this unit	48
Basic operations via the TV screen display	48
Configuring settings specific to an individual input source (OPTION menu)	50
OPTION menu display and setup.....	50
OPTION menu	51
Confirming and operating input sources from the Content window	54
Displaying the Content window on the TV screen.....	54
Switching the display between the Now Playing view and the Content browse view	54
FM/AM tuning	55
Selecting a frequency for reception (Normal tuning).....	55
Confirming and operating the FM/AM tuner from the Content window	57
Playing back tunes from your iPod™/iPhone™	59
Connecting the Universal Dock for iPod/iPhone	59
Controlling an iPod™/iPhone™	59
Playing iPod/iPhone from the menu screen (Menu browse control)	60
Operating basic playback functions via the remote control (Simple remote control)	62
Playing iPod™/iPhone™ with wireless connection	62

Playing back tunes from Bluetooth™ components	64
Connecting a Yamaha Bluetooth wireless audio receiver	64
Pairing Bluetooth™ components	64
Using Bluetooth™ components	65

SETUP

Configuring input sources (Input menu)	66
Configuring input sources	66
Input menu.....	67
Editing the SCENE function (SCENE menu)	70
Editing a scene.....	70
SCENE menu.....	71
Setting sound program parameters	
(Sound Program menu)	73
Editing sound programs.....	73
CINEMA DSP parameters	74
Parameters usable in certain sound programs	76
Parameters usable in surround decoder	77
Setting various functions (Setup menu)	78
Operating the Setup menu	78
Setup menu	79
Manages settings for speakers	79
Setting the audio output function of this unit	83
Setting this unit's video output function.....	84
Setting HDMI functions	85
Setting this unit's multi-zone function	88
Making the receiver easier to use	88
Language	91
Confirming information of this unit	
(Information menu)	92
Selecting information	92
Controlling other components	
with the remote control.....	93
Keys connecting external components	93
Default remote control code settings.....	94
Registering remote control codes	
for external component operations	94
Resetting all remote control codes	95
Extended functionality that can be configured	
as needed (Advanced Setup menu).....	96
Displaying/Setting the Advanced Setup menu	96
Setting the impedance of speakers	96

Avoiding crossing remote control signals	
when using multiple Yamaha receivers	97
Changing TV format	97
Removing HDMI video output up-scaling limits.....	97
Changing FM/AM frequency steps	
(Asia and General models only).....	98
Initializing various settings for this unit.....	98
Using the HDMI Control function	99
Using multi-zone configuration	103
Connecting Zone2	103
Controlling Zone2	104
Using the party mode	104

APPENDIX

Troubleshooting	105
General	105
HDMI™	107
Tuner (FM/AM)	108
iPod™/iPhone™	109
Bluetooth™	109
Remote control	110
Glossary	111
Audio information	111
Sound program information	112
Video information	112
Video conversion	113
Information on HDMI™	114
About trademarks.....	114
Specifications.....	115
Index	117

INTRODUCTION

Features and capabilities

■ Built-in high-quality, high-power 7-channel amplifier	
■ 6 HDMI input jacks (5 + 1 VIDEO AUX) supporting Audio Return Channel and 3D video signal	
■ 2 HDMI output jacks	
– Selecting the HDMI OUT jack	40
■ 1-button input/sound program switching (SCENE function).....	42
■ Speaker connections for 2- to 7.1-channel configurations	
– Speaker impedance configuration	18
– Speaker channels and functions	13
– Speaker layout.....	14
– Speaker cable connection.....	17
– Subwoofer cable connection	19
– High quality playback using bi-amplification connections	18
■ Automatic settings for speaker acoustic parameters (YPAO - Yamaha Parametric Room Acoustic Optimizer)	32
■ External component connection (max. 16 inputs) and playback	
– External component connection.....	20
– Protective cover for front panel jacks	7
– Configuring the settings specific for each input source <OPTION menu>.....	50
– Playback from external components.....	40
– Playback from an iPod/iPhone with wired connection	60
– Playback from an iPod/iPhone with wireless connection	62
– Playback from a Bluetooth component (Bluetooth and components sold separately)	64
■ FM/AM tuner	
– Receiving an FM/AM broadcast	55
– Presetting stations	55
– Simple preset tuning	55
– Changing FM mode (Stereo/Mono).....	57
– (Asia and General models only) Changing FM/AM frequency steps	55
■ Multi-channel, multi-format playback	
– Sound field effect selection.....	42
– Playback without sound field effects	43
– Stereo playback.....	43
– Compressed-music playback	45
■ Front panel information display/on-screen display (OSD) on the TV screen	
– Switching information on the front panel display	10
– Operating this unit using the on-screen display.....	12
■ Volume adjustment functions	
– Easy listening at low volumes < Adaptive DRC>	52
– Adjusting volume between input sources <Volume Trim>	53
■ Remote control operation	
– External component operation with this unit’s remote control.....	93
– Multiple Yamaha receiver operation without signal interference <Remote ID Switching>.....	97
■ Playing back the audio source in another room	
– Using the internal amplifier for playback	18
– Using the external amplifier for playback	103
– Configuring the settings for another room.....	103
– Controlling the external component in another room.....	104
■ Other features	
– Standby mode after a specific amount of time <Sleep timer>.....	11
– Charging the iPod/iPhone when this unit is in standby mode <iPod Standby Charge>	68

Most of this unit’s functions can be operated by following instructions displayed on the TV screen. Refer to “Using the TV OSD to operate the unit” on the following pages for information on functions that can be controlled using the on-screen display.



Using the TV OSD to operate the unit

This unit features a sophisticated on-screen display (OSD) for the TV screen. The OSD is designed to enable visual guidance that simplifies operations. The OSD mainly displays the ON SCREEN and OPTION menus, as well as the Content window that displays the content of current input sources.

■ Select an input source, SCENE and sound program

- Select an input source48
- Select a SCENE49
- Select a sound program49

View or modify content for the current input source <Content window>

■ Operate the AM/FM tuner

- Display a list of preset stations for selection58
- Display information on the station currently received57
- Perform operations such as searching for and registering stations using the Utility <Utility>57

■ Display the list of iPod music sources

- Display the list of iPod music sources for selection60
- Perform operations such as play, stop and pause using the TV screen <Menu browse control>60
- Perform basic playback functions such as play, stop and pause via the remote control <Simple remote control>62

Configuring settings for this unit <ON SCREEN menu>

- Display the ON SCREEN menu on the TV screen48

■ Select and configure an input source

- Select an input source48
- Play the audio/video signal from the selected input source40
- Change the input source name <Rename/Icon Select>67
- Select the audio input jack separately from the video input jack <Audio In>68
- Specify a format for digital audio signals <Decoder Mode>68
- Enhance the sound of compressed audio <Enhancer>68
- Output a video signal input from another input source while playing a multi-channel audio signal <Video Out>69
- Charge the iPod/iPhone when this unit is in standby mode <Standby Charge>68

■ Select and customize a SCENE

- Select a SCENE49
- Register or clear settings for a selected SCENE <Save>, <Reset>71
- Turn on a Yamaha BD/DVD player or CD player connected to this unit automatically when a SCENE is selected <SCENE IR>71

■ Select and adjust a sound program (sound program)

- Select a sound program49
- Adjust sound program parameters73

■ Display settings information for this unit

- Display audio signal information <Audio Signal>92
- Display video signal information <Video Signal>92
- Display HDMI signal information <HDMI - Monitor Info.>92

■ Adjust acoustic parameters to match your speakers and listening environment

- Specify speaker acoustic parameters automatically (Yamaha Parametric Room Acoustic Optimizer - YPAO)32
- Set up this unit's speaker configuration simply <Power Amp Assign>79
- Specify settings for each speaker <Configuration>80
- Control volume control for each speaker <Level>81
- Apply speaker distance settings <Distance>81
- Control equalizer sound quality <Parametric EQ>82
- Adjust test tone speaker <Test Tone>82

■ Adjust audio signals output from this unit

- Correct lag between audio and video signals <Lipsync>83
- Select a dynamic range adjustment method <Dynamic Range>83
- Specify the maximum volume <Max Volume>83
- Specify the initial volume <Initial Volume>84
- Adjust DSP effect and volume level <Adaptive DSP Level>84

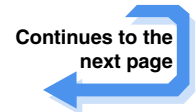



- **Adjust video signals output from this unit**
 - Convert analog video signal to another type of signal <Analog to Analog Conversion>84
 - Specify the resolution and aspect ratio of analog video signal converted to HDMI or specify upscaling resolution for 480i/576i- or 480p/576p-HDMI output signal <Processing>85
- **HDMI settings**
 - Assign the audio input source for the TV <TV Audio Input>.....86
 - Listen to TV audio with HDMI cable connection <ARC (Audio Return Channel)>.....86
 - Transmit HDMI audio/video to the TV during standby mode <Standby Through>87
 - Change the output destination of HDMI input audio signals <Audio Output>.....87
- **Enable listening in multiple rooms (multi-zone function)**
 - Adjust Zone2 volume <Zone2 Set>.....88
- **Specify other functions for this unit**
 - Enter standby mode automatically when no operations are performed <Auto Power Down>.....89
 - Adjust the brightness of the front panel display <Dimmer>89
 - Change the wall paper displayed on the TV screen <Wall Paper>.....89
 - Specify the function of the TRIGGER OUT jack for controlling external components
<Trigger Output>90
 - Prohibit changes to settings <Memory Guard>91
- **Select a language**
 - Change the language displayed on the TV screen <Language>.....91





Adjust settings for each input source <OPTION menu>

- Display the OPTION menu on the TV screen50
- Select the 5.1-channel signal playback method <Extended Surround>.....52
- Adjust bass and treble levels <Tone Control>51
- Enable low-volume background music <Adaptive DRC>.....52
- Adjust the volume of input sources <Volume Trim>.....53
- Adjust the vertical position of dialogues <Dialogue Lift>52



About this manual

- Some features are not available in certain regions.
- This manual is created prior to production. Design and specifications are subject to change in part as a result of improvements, etc. In case of differences between the manual and product, the product has priority.
- “**4**HDMI” (example) indicates the name of the parts on the remote control. Refer to the “Remote control” (p. 11) for the information about each position of the parts.
-  1 indicates that the reference is in the footnote. Refer to the corresponding numbers on the bottom of the page.
-  indicates the page describing the related information.
- Click on the “” at the bottom of the page to display the corresponding page in “Part names and functions.”

-  Front panel
-  Rear panel
-  Front panel display
-  Remote control

Supplied accessories

Check that you received all of the following parts.

- Remote control
- Batteries (AAA, R03, UM-4) x 2
- YPAO microphone
- AM loop antenna
- Indoor FM antenna
- VIDEO AUX input cover

■ Attaching the VIDEO AUX input cover (supplied)

To protect against dust, attach the supplied VIDEO AUX input cover to the VIDEO AUX jacks when you do not use the jacks. To remove the cover, push the left section of it.

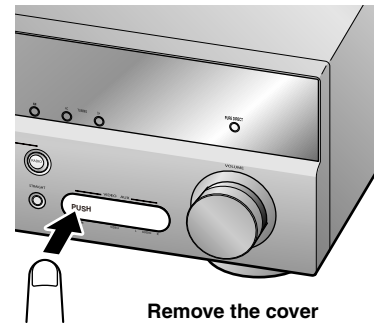
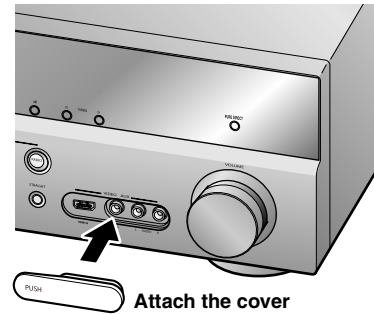

■ Installing batteries in the remote control

When inserting batteries in the remote control, remove the battery compartment cover from the reverse side of the remote control, and insert two AAA batteries into the battery compartment so that they match with the polarity markings (+ and -).

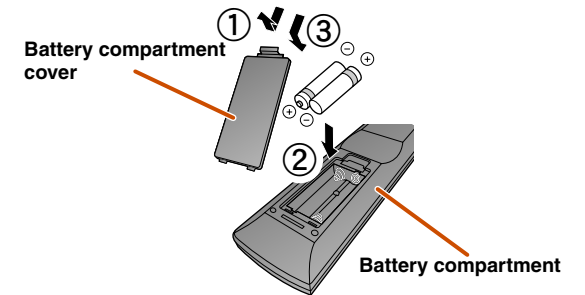

Replace the batteries with new ones if the remote control can only be operated within a narrow range.

NOTE

If there are remote control codes for external components registered to the remote control, removing the batteries for more than 2 minutes, or leaving exhausted batteries in the remote control, may clear the remote control codes. If this should occur, replace the batteries with new ones, and set the remote control codes.

Part names and functions

Front panel

① **MAIN ZONE**  (Power)

Switches this unit between on and standby mode.

② **HDMI Through/iPod Charge indicator**

Lights up in any of the following cases while the unit is in standby mode.

- When the Standby Through function is enabled and audio/video from an external component connected with HDMI is output to a TV during standby mode ([p. 87](#)).
- When an iPod/iPhone, which is placed in the Universal Dock for iPod/iPhone, is charging while the unit is in standby mode ([p. 62](#)). This indicator also lights up when the Yamaha iPod wireless receiver is connected to this unit ([p. 62](#)).

③ **ZONE2**

Switches to enable/disable the audio output to Zone2 ([p. 104](#)).

④ **ZONE CONTROL**

Switches to Zone2 operation mode. This unit, or its remote control, can be used to select input sources or adjust volume for an external amplifier in another room or the built-in amplifier for speakers in another room ([p. 104](#)).

⑤ **INFO**

Changes the information displayed on the front panel display ([p. 10](#)).

⑥ **MEMORY**

Registers FM/AM stations as preset stations ([p. 56](#)). 

⑦ **PRESET** < / >

Selects an FM/AM preset station ([p. 57](#)). 

⑧ **FM/AM**

Sets the FM/AM tuner band to FM or AM ([p. 55](#)). 

⑨ **Front panel display**

Displays information on this unit ([p. 10](#)).

⑩ **TUNING** << / >>

Changes FM/AM tuner frequencies ([p. 55](#)). 

⑪ **PURE DIRECT**

Switches this unit to Pure Direct mode ([p. 45](#)).

⑫ **INPUT selector**

Selects an input source from which to playback. Rotate this selector to cycle through the input sources in order.

⑬ **PHONES jack**

For plugging headphones in. Sound effects applied during playback can also be heard through the headphones.

⑭ **YPAO MIC jack**

Connect the supplied YPAO microphone and adjust the speaker balance automatically ([p. 32](#)).

⑮ **TONE CONTROL**

Adjusts high-frequency/low-frequency output of speakers/headphones ([p. 41](#)).

⑯ **SCENE**

Switches the input source, the sound program, and the HDMI OUT with a single button ([p. 42](#), [p. 70](#)). When this unit is in standby mode, press this key to switch on.

⑰ **PROGRAM selector**

Selects a sound program ([p. 42](#)). Rotate this selector to cycle through sound programs.

⑱ **STRAIGHT**

Changes a sound program to straight decoding mode ([p. 43](#)).

⑲ **VIDEO AUX jacks**

For connecting game consoles to this unit temporarily ([p. 28](#)). Attach the supplied VIDEO AUX input cover when not using this jack ([p. 7](#)).

⑳ **VOLUME**

Adjusts the volume level.

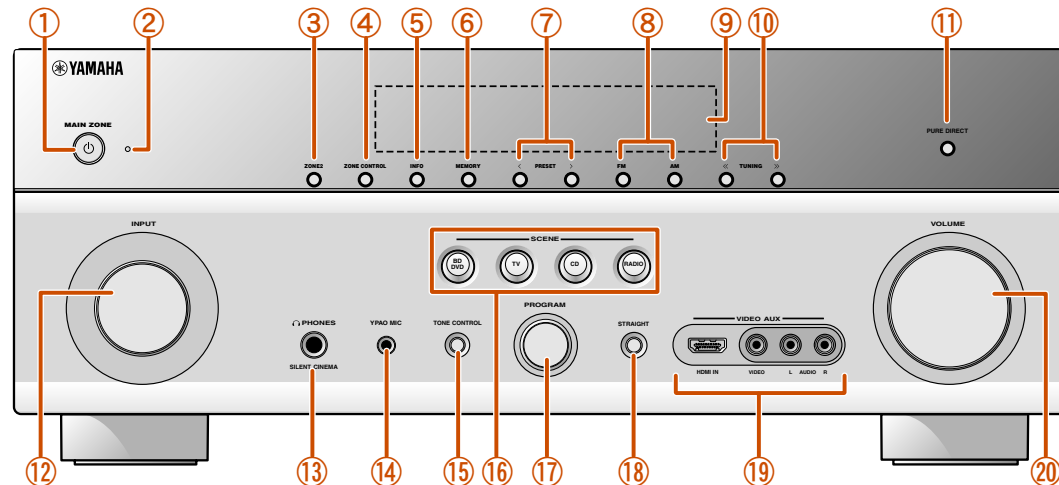

 1: Usable when you have selected TUNER input.

Rear panel

① **DOCK jack**

For connecting an optional Universal Dock for iPod/iPhone (such as YDS-12), iPod wireless receiver (YID-W10), or Bluetooth wireless audio receiver (YBA-10) (p. 59, p. 62, p. 64).

② **PHONO jacks**

For connecting a turntable (p. 27).

③ **HDMI OUT 1-2 jacks**

For connecting an HDMI - compatible TV to output audio/video signals (p. 22).

④ **ANTENNA jacks**

For connecting AM and FM antennas (p. 31).

⑤ **MONITOR OUT jacks**

VIDEO jack

For connecting a TV capable of receiving video input, and outputting video signals to it (p. 22).

COMPONENT

VIDEO jacks

For connecting TV that are compatible with component video signals, using three cables to output video signal (p. 22).

⑥ **REMOTE IN/OUT jacks**

For connecting an external component that supports the remote control function (p. 29).

⑦ **HDMI1-5 jacks**

For connecting external components equipped with HDMI-compatible outputs to receive audio/video signals (p. 24).

⑧ **SPEAKERS terminals**

For connecting the front, center, surround and surround back speakers (p. 17). Connect the presence speakers (p. 17) or the speakers for Zone2 (p. 18) to the EXTRA SP jacks.

⑨ **VOLTAGE SELECTOR**

(Asia and General models only)

Select the switch position according to your local voltage (Refer to Quick Reference Guide).

⑩ **Power cable**

For connecting this unit to an AC wall outlet.

⑪ **AV1-6 jacks**

For connecting to external components equipped with audio/video outputs to receive audio/video signals (p. 25).

⑫ **AV OUT jacks**

For outputting audio/video signals received when analog inputs (AV3-6 or AUDIO1-2) are selected (p. 30).

⑬ **AUDIO1-2 jacks**

For connecting external components equipped with analog audio outputs to input sound into this unit (p. 27).

⑭ **TRIGGER OUT jack**

For connecting an external component that supports the trigger function to operate it linked with operation of this unit (p. 30).

⑮ **MULTI CH INPUT jacks**

For connecting a player that supports a multi-channel output (p. 28).

⑯ **AUDIO OUT jacks**

For outputting audio signals received when analog jacks, such as the AV5-6 or AUDIO1-2 are selected (p. 30).

⑰ **ZONE2 OUT jacks**

Outputs sound of this unit to an external amplifier set in a different room. (p. 103).

⑱ **PRE OUT terminals**

For connecting a subwoofer with built-in amplifier or an external power amplifier (p. 19, p. 29).

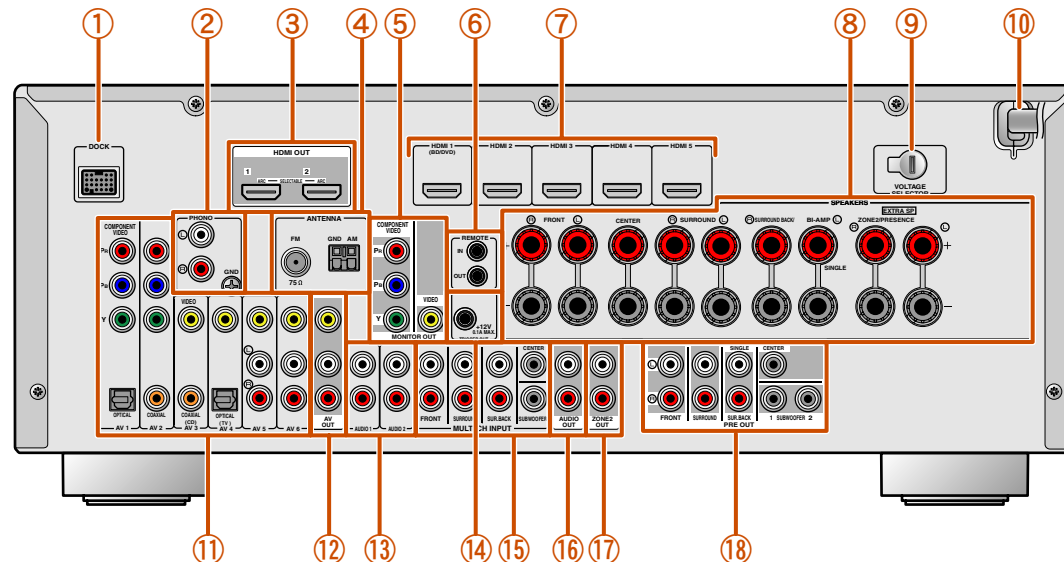

Distinguishing the input and output jacks

The area around the audio/video output jacks is marked in white to prevent connection errors. Use these jacks to output audio/video signals to a TV or other external component.

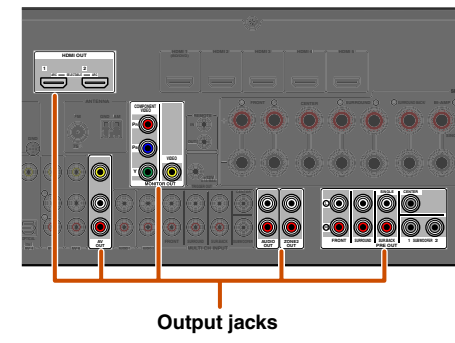

Front panel display

- ① **HDMI indicator**
Lights up during normal HDMI communication when any of the HDMI1-5 inputs are selected.
- OUT 1/OUT 2 indicators**
Lights up which outputs audio/video signals from the HDMI OUT jack (p. 22).
- ② **CINEMA DSP indicator**
Lights up when a sound field effect that uses CINEMA DSP technology is selected.
- ③ **ENHANCER indicator**
Lights up when the Compressed Music Enhancer mode is turned on (p. 45).
- ④ **CINEMA DSP 3D indicator**
Lights up when CINEMA DSP 3D is activated (p. 44).
- ⑤ **Tuner indicator**
Light up according to the status of a received station (p. 55).
- ⑥ **SLEEP indicator**
Lights up when the sleep timer is on (p. 11).
- ⑦ **ZONE2 indicator**
Lights up when the audio output to Zone2 is enabled (p. 104).

- ⑧ **MUTE indicator**
Flashes when audio is muted.
- ⑨ **VOLUME indicator**
Displays the current volume level.
- ⑩ **Cursor indicators**
Light up if corresponding cursors on the remote control are available for operations.
- ⑪ **Multi information display**
Displays a range of information on menu items and settings.
- ⑫ **Speaker indicators**
Indicate speaker terminals from which signals are output.

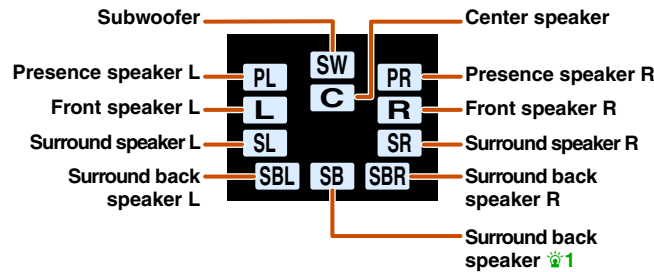

Switching information on the front panel display

The front panel can display sound programs and surround decoder names as well as the active input source. Press **INFO Key** repeatedly to cycle through input source → sound program → surround decoder in order.

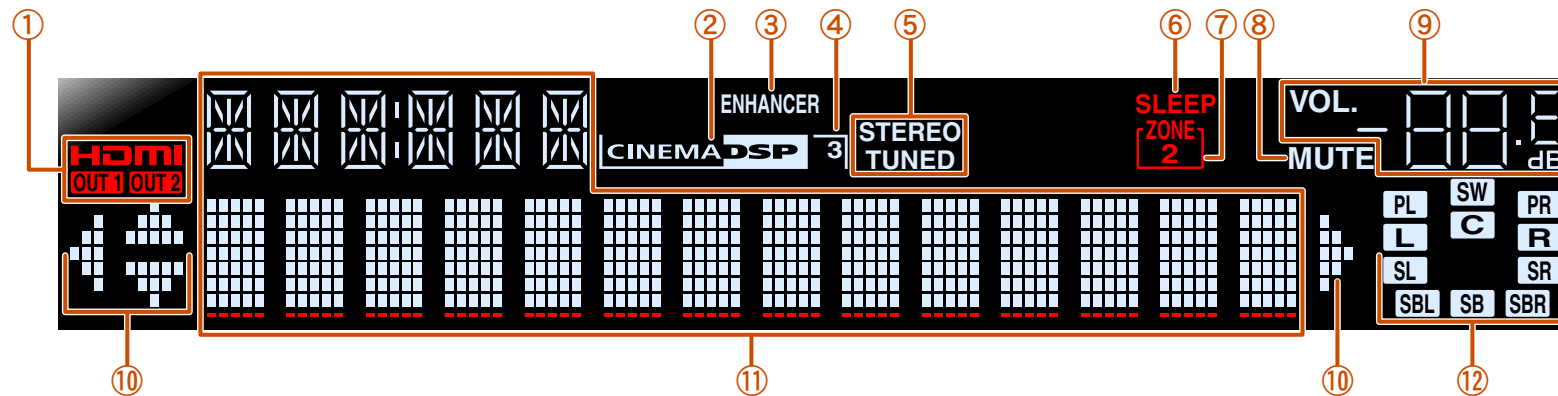
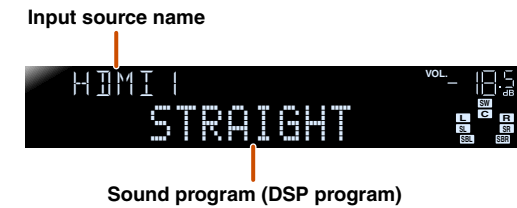

1: "SB" is displayed when using a 6.1-channel configuration only.
 2: During FM/AM reception, the frequency is displayed instead of the input source.

Remote control

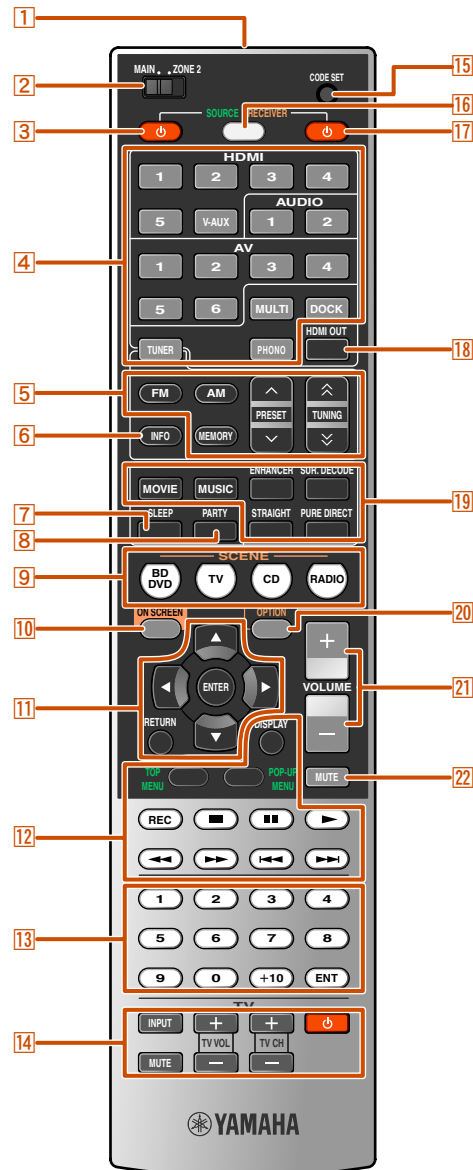

- 1 Remote control signal transmitter**
Transmits infrared signals.
- 2 MAIN/ZONE2**
Switches the zone to be operated by the remote control between the Main zone and Zone2 (p. 104).
- 3 SOURCE ϕ (SOURCE Power)**
Switches an external component on and off.
- 4 Input selector**
Select an input source on this unit from which to playback.

HDMI1-5	HDMI1-5 jacks
V-AUX	Front panel VIDEO AUX jacks
AUDIO1-2	AUDIO1-2 jacks
AV1-6	AV1-6 jacks
MULTI CH INPUT	MULTI CH INPUT jacks
DOCK	A Universal Dock for iPod/iPhone, iPod wireless receiver, or Bluetooth wireless audio receiver connected to the DOCK jack.

TUNER	FM/AM tuner
PHONO	PHONO jacks
- 5 Radio control keys**
Operates the FM/AM tuner. These keys are used when using the tuner input.

FM	Sets the FM/AM tuner band to FM.
AM	Sets the FM/AM tuner band to AM.
MEMORY	Presets radio stations.
PRESET \wedge / \vee	Selects a preset station.
TUNING \wedge / \vee	Changes tuning frequencies.
- 6 INFO**
Cycles the information displayed on the front panel display (the name of the currently selected input source, the sound program, the surround decoder, the FM/AM tuner frequency, etc.).
- 7 SLEEP**
Switches this unit to standby mode automatically after a specified period of time has elapsed (sleep timer). Press this key repeatedly to set the time for the sleep timer function.

→ Sleep 120min. → Sleep 90min. →
Sleep Off ← Sleep 30min. ← Sleep 60min. ←

The SLEEP indicator lights up when the sleep timer is on.

- 8 PARTY**
Switches the party mode on and off (p. 104).
- 9 SCENE**
Switch the input source and the sound program with a single button (p. 42). When this unit is in standby mode, press this key to switch on.
- 10 ON SCREEN**
Turns on and off the ON SCREEN menu.
- 11 Cursor Δ / ∇ / \triangleleft / \triangleright , ENTER, RETURN**

Cursor Δ / ∇ / \triangleleft / \triangleright	Select menu items and change settings when menus, etc. are displayed.
ENTER	Confirms a selected item.
RETURN	Returns to the previous screen when menus are displayed, or close the menu.
- 12 External component operation keys**
Operate recording, playback, and menu displays etc. for external components (p. 93).
- 13 Numeric keys**
Enter numbers.
- 14 TV control keys**
Operate a monitor such as a TV.
- 15 CODE SET**
Sets remote control codes for external component operations (p. 94).
- 16 SOURCE/RECEIVER**
Switches remote control key function to operate this unit or an external component (p. 93). Operate an external component when this key glows green, or this unit when this key glows orange.
- 17 RECEIVER ϕ (RECEIVER Power)**
Switches this unit between on and standby mode.
- 18 HDMI OUT**
Switches the output jack connected to an HDMI compatible TV (p. 40).
- 19 Sound selection keys**
Switch between the sound field effect (sound program) you are using and the surround decoder (p. 42).
- 20 OPTION**
Turns on and off the OPTION menu (p. 50).
- 21 VOLUME +/-**
Adjust the volume level (p. 40).
- 22 MUTE**
Turns the mute function of the sound output on and off (p. 40).

1 : You can use **12 External component operation keys** for each input source to operate registered components. Remote control codes must be registered for each input in advance if you want to operate external components (p. 94).

On-screen display

When a TV is connected to this unit, the supplied remote control can be used to specify and verify this unit's settings via menus and options displayed on the TV screen.

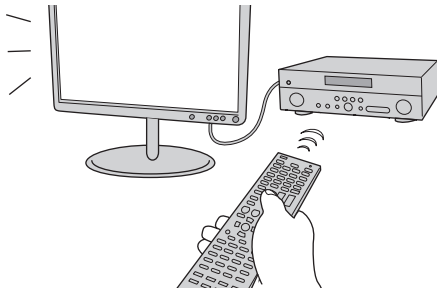

The following displays are available in the on-screen display.

ON SCREEN menu

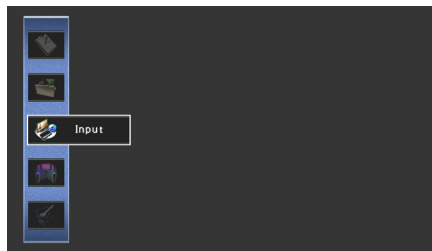

Detailed settings for this unit can be configured. Use this menu to select desired settings, change their values, or check the current status of this unit. Refer to "SETUP" ([p. 66](#)) for details.

OPTION menu



Configure the optional settings for each input source. Settings such as "Tone Control" and "Volume Trim" are applied to this unit regardless of the input source. Refer to "Configuring settings specific to an individual input source (OPTION menu)" ([p. 50](#)) for details.

■ Displaying the following menus or viewing the current status of this unit on the TV screen

- ON SCREEN menu
Press ON SCREEN to display the ON SCREEN menu.
- OPTION menu
Press OPTION to display the OPTION menu.
- Content window
Press **Input selector** to display the Content window.

Content window

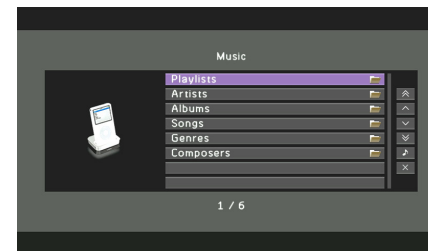

Includes the Content browse view and the Now Playing view. The Now Playing view displays the status of the source from which music is currently played back. Adjust settings for music content from the Content browse view. Refer to "Confirming and operating input sources from the Content window" ([p. 54](#)) for details.

CONNECTIONS

Connecting speakers

This unit uses acoustic field effects and sound decoders to bring you the impact of a real movie theater or concert hall. These effects will be brought to you with ideal speaker positioning and connections in your listening environment.

Speaker channels and functions

Front left and right speakers

The front speakers are used for the front channel sounds (stereo sound) and effect sounds.

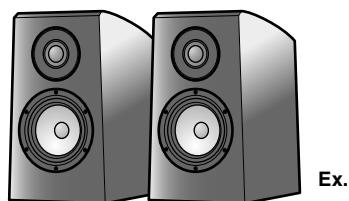

Front speaker layout:

Place these speakers at an equal distance from the ideal listening position in the front of the room. When using a projector screen, the appropriate top positions of the speakers are about 1/4 of the screen from the bottom.

Center speaker

The center speaker is for the center channel sounds (dialog, vocals, etc.).



Center speaker layout:

Place it halfway between the left and right front speakers. When using a TV, place the speaker just above or just under the center of the TV with the front surfaces of the TV and the speaker aligned. When using a screen, place it just under the center of the screen.

Surround left and right speakers

The surround speakers are for effect and vocal sounds with the 5.1-channel speakers providing rear-area sounds. When used with 6.1/7.1-channel (including surround back channel), sound for right and left rear-area is output.

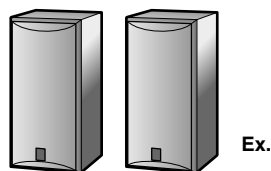

Surround speaker layout:

Place the speakers at the rear of the room on the left and right sides facing the listening position. They should be placed between 60 degrees and 80 degrees from the listening position and with the speaker tops at a height of 1.5 – 1.8 m from the floor.

Presence left and right speakers

The presence speakers are used for front effect sounds. When used in combination with the sound programs ([exp. 42](#)), a sound with a richer and more spatial presence is possible.

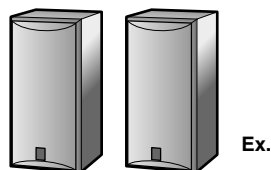

Presence speaker layout:

Place the left and right presence speakers 0.5 – 1 m to the outside of the left and right front speakers respectively. The tops of the presence speakers should be 1.8 m above the floor.

Surround back left and right speakers

Outputs the rear effect. When used with 6.1ch sound, sound from the left and right sound surround back speakers is mixed and output from a single speaker. When used with 5.1ch sound, sound from surround back speakers is distributed between the left and right surround speakers.

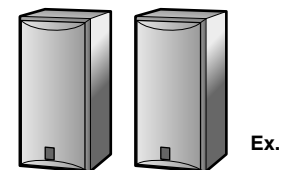

Surround back speaker layout:

When used with 7.1ch sound, arrange the left and right speakers towards the listening position, to the rear of the listening position. Arrange the left and right speakers at least 30 cm apart. The same separation as with the front left and right speakers is optimum. When used with 6.1ch sound, arrange these to the rear of the listening position.

Subwoofer

The subwoofer speaker is used for bass sounds and low-frequency effect (LFE) sounds included in Dolby Digital and DTS. Use a subwoofer that is equipped with built-in amplifier.

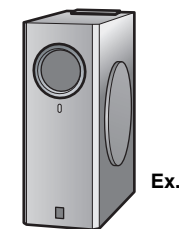

Subwoofer speaker layout:

Place it to the outside of the front left and right speakers facing slightly inward to reduce echoes from the wall.

Speaker layout

Enjoying the 7.1 channel audio source

7.1-channel speaker layout (7 speakers + subwoofer)

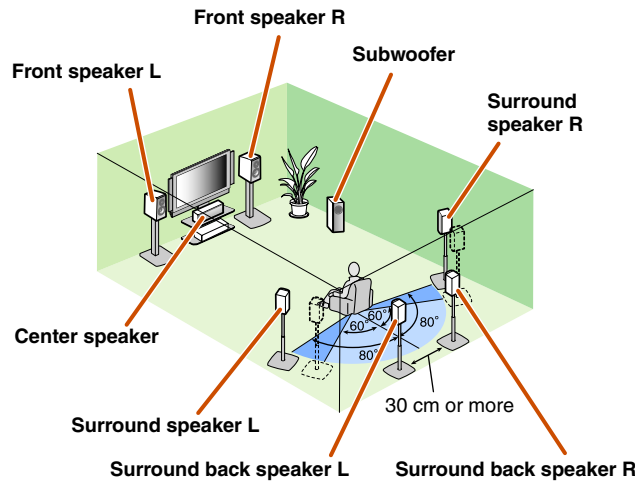

Audio from a 7.1-channel audio source can be played back with no degradation with this speaker configuration.

Connections of speakers

Connect the speakers to the following jacks according to the speaker layout. Refer to “Front/Center/Surround/Surround back speaker and Subwoofer connection” and “Presence speaker connection” for details on connecting speakers (p. 17).

Speaker jacks	FRONT L/R, CENTER, SURROUND L/R, SURROUND BACK L/R, SUBWOOFER
EXTRA SP jack	No used

Assigning a speaker configuration

A speaker configuration must be assigned to this unit to activate the speakers. Use the “Power Amp Assign” function to easily apply the appropriate speaker settings to this unit according to the speaker configuration. Speakers for this layout can be activated at the default “Power Amp Assign” setting (p. 79).

Power Amp Assign	7ch Normal (Default)
------------------	----------------------

Adding the presence speakers for a richer sound field effect

Presence speaker layout (7 speakers + subwoofer + presence speakers)

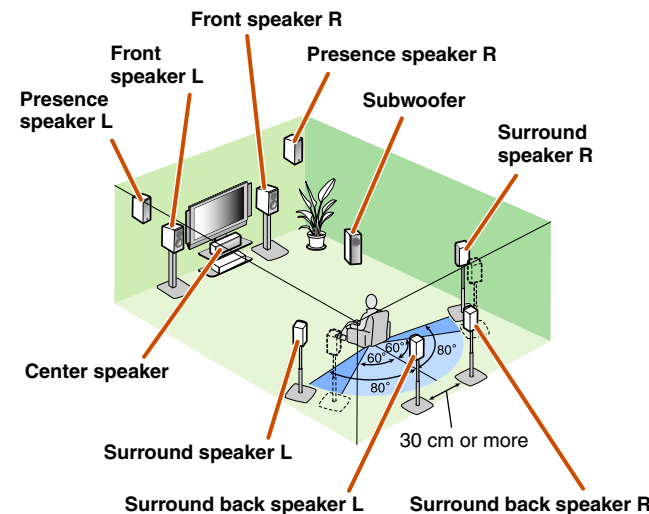

This unit automatically selects the presence speakers or surround back speakers to output sounds according to the selected sound program. When the sound program is changed, the speakers that output the sound are switched between the presence speakers and surround back speakers automatically.

Connections of speakers

Connect the speakers to the following jacks according to the speaker layout. Refer to “Front/Center/Surround/Surround back speaker and Subwoofer connection” and “Presence speaker connection” for details on connecting speakers (p. 17).

Speaker jacks	FRONT L/R, CENTER, SURROUND L/R, SURROUND BACK L/R, SUBWOOFER
EXTRA SP jack	Presence L/R speakers

Assigning a speaker configuration

A speaker configuration must be assigned to this unit to activate the speakers. Use the “Power Amp Assign” function to easily apply the appropriate speaker settings to this unit according to the speaker configuration. Speakers for this layout can be activated at the default “Power Amp Assign” setting (p. 79).

Power Amp Assign	7ch Normal (Default)
------------------	----------------------



Enjoying the 7.1 channel audio source without surround back speakers

5.1-channel speaker layout (5 speakers + subwoofer)

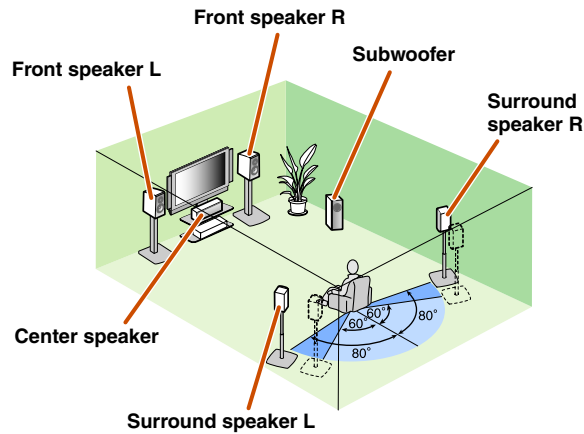

This unit can mix 7.1-channel audio source down to 5.1-channel sound. This enables 7.1-channel sound without surround back speakers.

Connections of speakers

Connect the speakers to the following jacks according to the speaker layout. Refer to “Front/Center/Surround/Surround back speaker and Subwoofer connection” and “Presence speaker connection” for details on connecting speakers ([p. 17](#)).

Speaker jacks	FRONT L/R, CENTER, SURROUND L/R, SUBWOOFER
EXTRA SP jack	No used

Assigning a speaker configuration

A speaker configuration must be assigned to this unit to activate the speakers. Use the “Power Amp Assign” function to easily apply the appropriate speaker settings to this unit according to the speaker configuration. Speakers for this layout can be activated at the default “Power Amp Assign” setting ([p. 79](#)).

Power Amp Assign	7ch Normal (Default)
------------------	----------------------

Using the front speakers that support bi-amp connections for a high quality sound

5.1-channel speaker layout (Front speakers (Bi-amp) + 3 speakers)

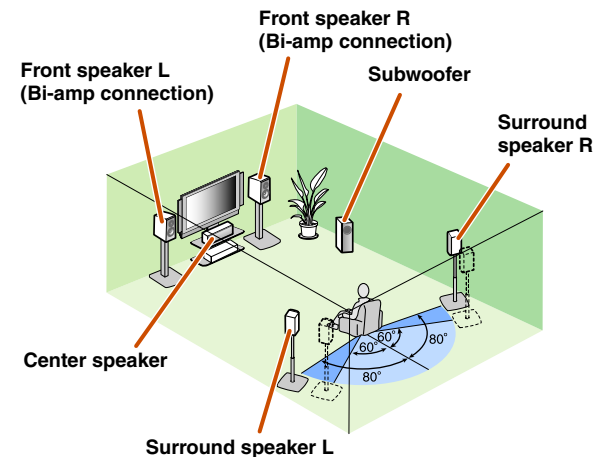

Using the front speakers that support bi-amp connections reproduces a high quality sound.

Connections of speakers

Connect the speakers to the following jacks according to the speaker layout. Refer to “Front/Center/Surround/Surround back speaker and Subwoofer connection” and “Bi-amp connection” for details on connecting speakers ([p. 17](#), [p. 18](#)).

Speaker jacks	FRONT L/R, CENTER, SURROUND L/R, SURROUND BACK L/R, SUBWOOFER
EXTRA SP jack	No used

Assigning a speaker configuration

Use the “Power Amp Assign” function which can easily apply the appropriate speaker settings to this unit according to the speaker configuration ([p. 79](#)).

Power Amp Assign	5ch BI-AMP
------------------	------------



Using speakers in two rooms (Zone2 function)

7.1-channel speaker layout + Zone2 (7 speakers (in main zone) + subwoofer (in main zone) + front speakers (in secondary zone))

Main zone

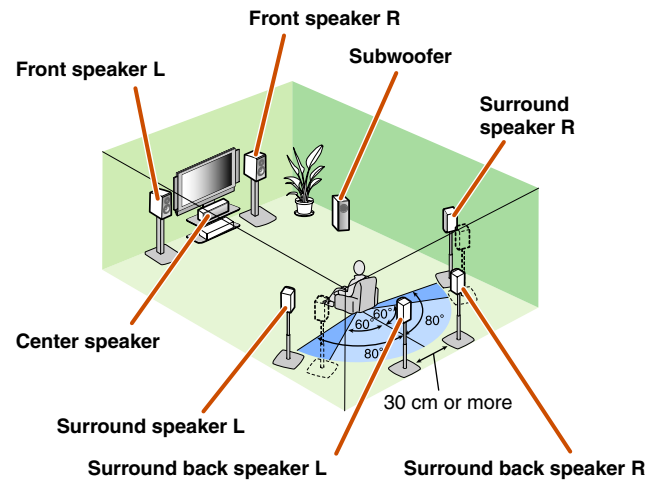

Zone2

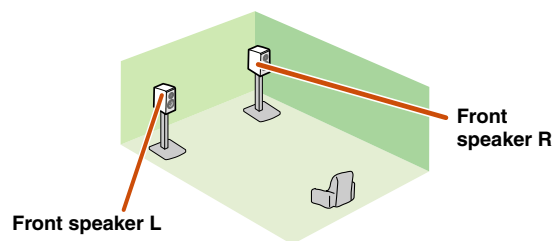

In addition to the main room, speakers in another room can also be controlled. When the built-in amplifier for the speakers in another room is turned on, the speakers that output the sound are switched from the surround back speakers to the speakers in another room automatically. 💡1

Connections of speakers

Connect the speakers to the following jacks according to the speaker layout. Refer to “Front/Center/Surround/Surround back speaker and Subwoofer connection” and “Multi-zone audio system using the internal amplifier of this unit” for details on connecting speakers ([p. 17](#), [p. 18](#)).

Speaker jacks	FRONT L/R, CENTER, SURROUND L/R, SURROUND BACK L/R, SUBWOOFER
EXTRA SP jack	Zone2 speakers

Assigning a speaker configuration

Use the “Power Amp Assign” function which can easily apply the appropriate speaker settings to this unit according to the speaker configuration ([p. 79](#)).

Power Amp Assign	7ch + 1ZONE
------------------	-------------

💡 1: Sound cannot be output from both the surround back speakers and the speakers in the second zone at the same time.

Connecting speakers and subwoofer

Connect your speakers to their respective terminals on the rear panel.

CAUTION

- Remove the AC power cable of this unit from the power outlet before connecting the speakers.
- Generally speaker cables consist of two parallel insulated cables. One of these cables is a different color, or has a line running along it, to indicate different polarity. Insert the different colored (or lined) cable into the “+” (positive, red) terminal on this unit and the speakers, and the other cable into the “-” (negative, black) terminal.
- Be careful that the core of the speaker cable does not touch anything or come into contact with the metal areas of this unit. This may damage this unit or the speakers. If the speaker cables short circuit, “CHECK SP WIRES!” will appear on the front panel display when this unit is switched on.

■ Front/Center/Surround/Surround back speaker and Subwoofer connection

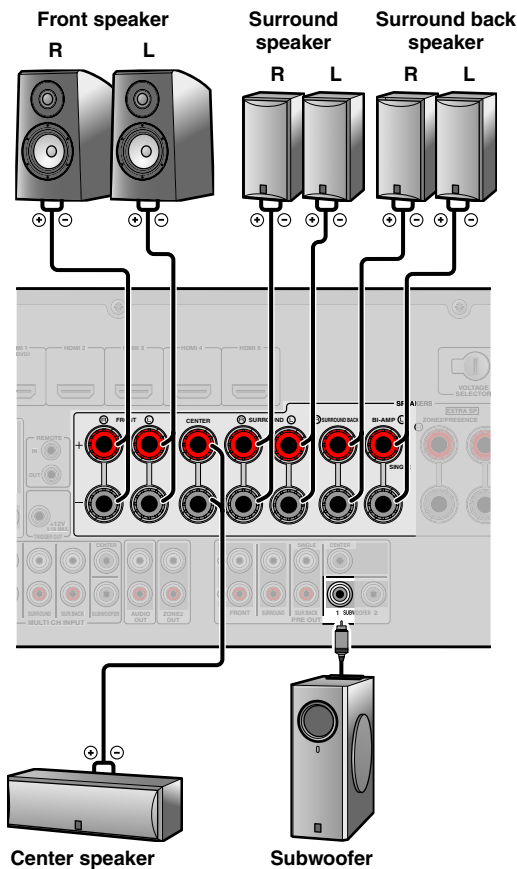

■ Presence speaker connection

When using the presence speakers, connect the speakers to the EXTRA SP jacks as shown in the diagram below.

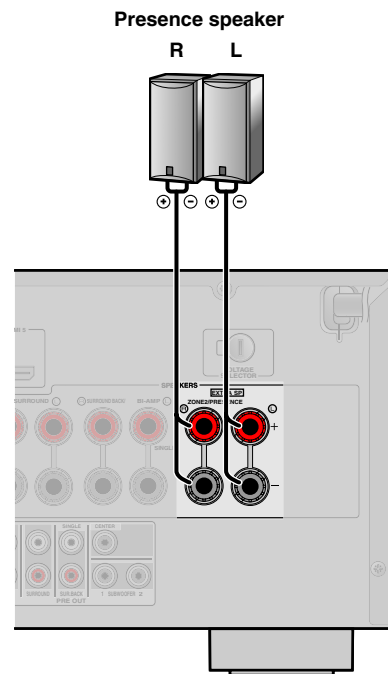

The presence speakers (PL/PR) that output front effect sounds can be connected to this unit. With the sound programs (p. 46), sound with a richer and more spatial presence can be created.

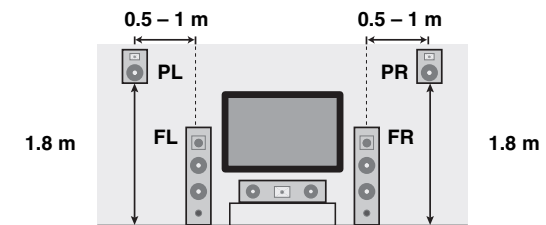

- Connection of presence speakers is recommended to take full advantage of the effects of CINEMA DSP sound programs.
- Although you can connect both surround back speakers and presence speakers to this unit, you cannot output sounds from those speakers at the same time.

Continues to the next page

■ Bi-amp connection

This unit can be connected to speakers that support bi-amp connections. When connecting speakers, connect the FRONT jacks and the SURROUND BACK/BI-AMP jacks as in the diagram below. Configure the bi-amp settings to activate connections.

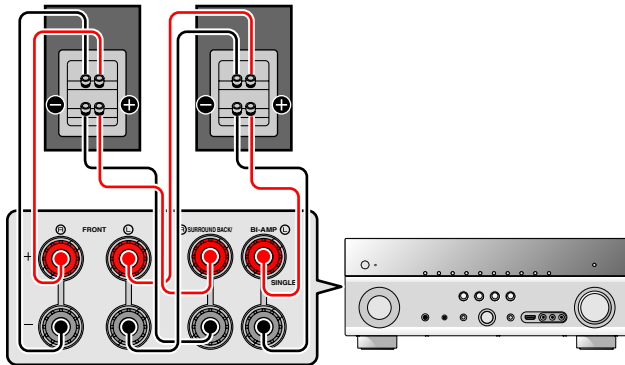

NOTES

- Before making bi-amplification connections, remove any brackets or cables that connect a woofer with a tweeter. Refer to the instruction manuals of speakers for details. When not making bi-amplification connections, make sure that the brackets or cables are connected before connecting the speaker cables.
- If connecting a bi-amp, then surround back speakers cannot be used.

■ Multi-zone audio system using the internal amplifier of this unit

Connect the speakers in the second zone to the EXTRA SP jacks as in the diagram below.

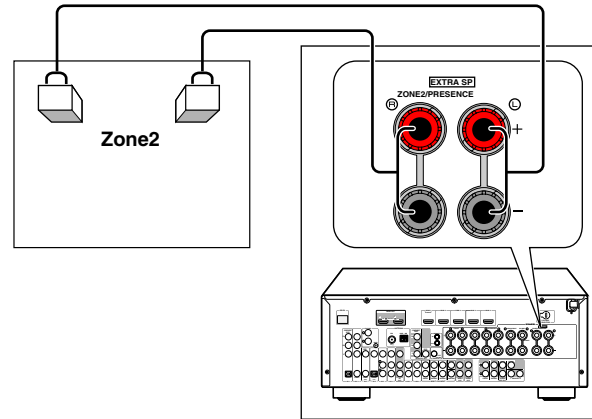

CAUTION

The EXTRA SP jacks of this unit should not be connected to a Passive Loudspeaker Selector Box or more than one loudspeaker per channel. Connection to a Passive Loudspeaker Selector Box or multiple speakers per channel could create an abnormally low impedance load resulting in amplifier damage. See this owner's manual for correct usage. Compliance with minimum speaker impedance information for all channels must be maintained at all times. This information is found on the back panel of this unit.

■ Changing speaker impedance

This unit is configured for 8 Ω speakers at the factory setting. When connecting to 6 Ω speakers, carry out the following procedure to switch to 6 Ω. When this unit is configured for 6 Ω speakers, 4 Ω speakers can also be used as the front speakers.

- 1 Switch this unit to the standby mode.
- 2 Press **MAIN ZONE** while pressing and holding **STRAIGHT** on the front panel.

Release the keys when “ADVANCED SETUP” is displayed on the front panel display.

After approximately a few seconds, the top menu item is displayed. 1

MAIN ZONE

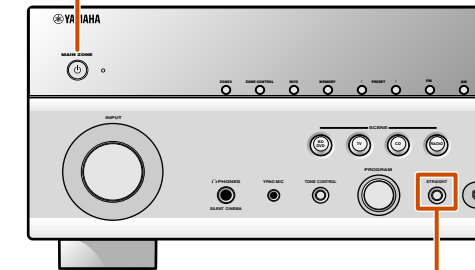

STRAIGHT

Continues to the next page

1: Refer to the “Extended functionality that can be configured as needed (Advanced Setup menu)” (see p. 96) for details on the Advanced Setup menu.

- 3 Check that “SP IMP.” is displayed on the front panel.



- 4 Press STRAIGHT repeatedly to select a “6ΩMIN.”

- 5 Switch this unit to the standby mode, and then switch it on again.

The power turns on, when the settings you made has been configured.

Connecting speakers

This type of jack can connect to the following speakers or connection.

- Front L/R speakers
- Center speaker
- Surround L/R speakers
- Surround back L/R speakers
- Bi-amp connection (Front speaker L/R speakers)

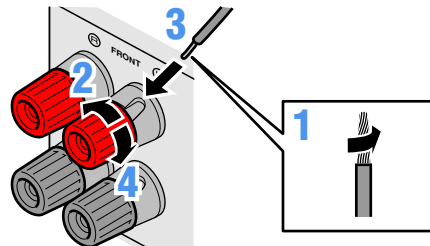

- 1 Remove approximately 10 mm of insulation from the ends of the speaker cables, and twist the bare wires of the cables together firmly so that they will not cause short circuits.

- 2 Loosen the speaker terminals.

- 3 Insert the bare wire of the speaker cable into the gap on the side of the terminal.

- 4 Tighten the terminal.

Connecting the subwoofer

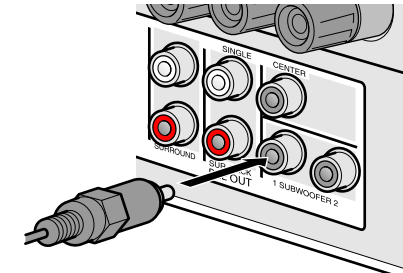

- 1 Connect the subwoofer input jack to the SUBWOOFER 1 or 2 jack on this unit with an audio pin cable.

- 2 Set the subwoofer volume as follows.
Volume: Set to approximately half volume (or slightly less than half).
Crossover frequency (if available): Set to maximum.

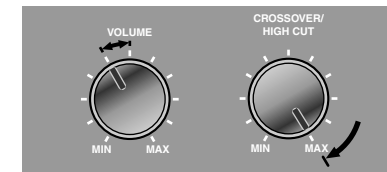

Subwoofer examples

NOTE

After connection, applying this setting to this unit is required to activate all speaker connections. With using “Power Amp Assign” function, you can easily apply the speaker configuration.

Refer to “Power Amp Assign” ([step. 79](#)) for details on using “Power Amp Assign” function.

Connecting external components

Cable plugs and jacks

This unit is equipped with the following input/output jacks. Use jacks and cables appropriate for components that you are going to connect.

Audio/Video jacks

HDMI jacks

Digital video and digital sound are transmitted through a single jack.
Only use an HDMI cable.

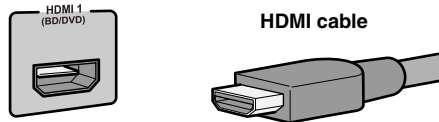

- Use a 19-pin HDMI cable with the HDMI logo.
- We recommend using a cable less than 5.0 m long to prevent signal quality degradation.
- When a TV that supports HDMI functions and Audio Return Channel function is connected, audio output from the TV can be input to this unit ([see p. 101](#)).
- When a player and TV that support the 3D video format are connected to this unit, 3D content can be played back.
- If you connect this unit to a component that has a DVI jack, an HDMI/DVI-D cable is required.

Analog video jacks

COMPONENT VIDEO jacks

The signal is separated into three components:
luminance (Y), chrominance blue (PB), and chrominance red (PR).
Use component video pin cables with three plugs.

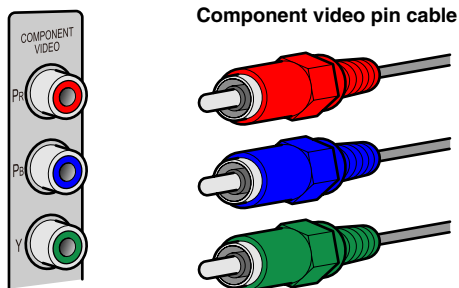

VIDEO jacks

These jacks transmit conventional analog video signals.
Use video pin cables.

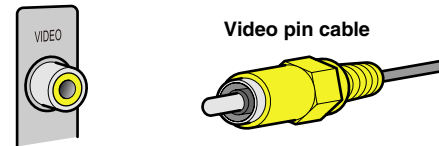

Audio jacks

OPTICAL jacks

These jacks transmit optical digital audio signals.
Use fiber-optic cables for optical digital audio signals.



COAXIAL jacks

These jacks transmit coaxial digital audio signals.
Use pin cables for digital audio signals.



AUDIO jacks

These jacks transmit conventional analog audio signals.
Use stereo pin cables, connecting the red plug to the red R jack, and the white plug to the white L jack.

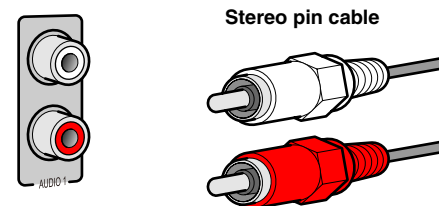

Connecting a TV monitor

This unit is equipped with the following three types of output jack for connection to a TV. HDMI OUT 1-2, COMPONENT VIDEO or VIDEO. Select the proper connection according to the input signal format supported by your TV.

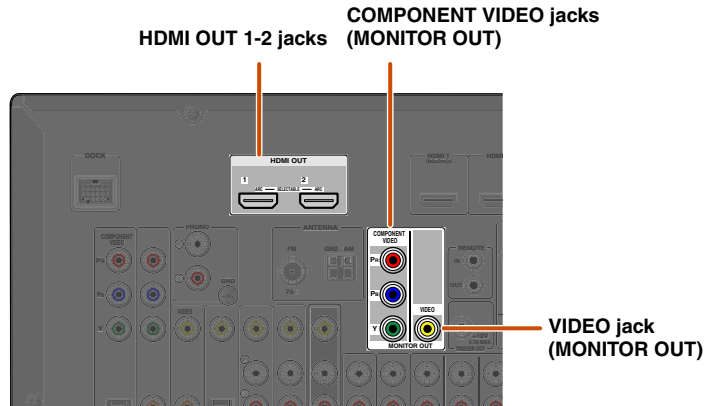

When connecting to an HDMI compatible TV

Video signal such as component video and video received by this unit is converted to HDMI and output to the TV. Just select HDMI input on the TV to view video from any external source connected to this unit. 🌟1

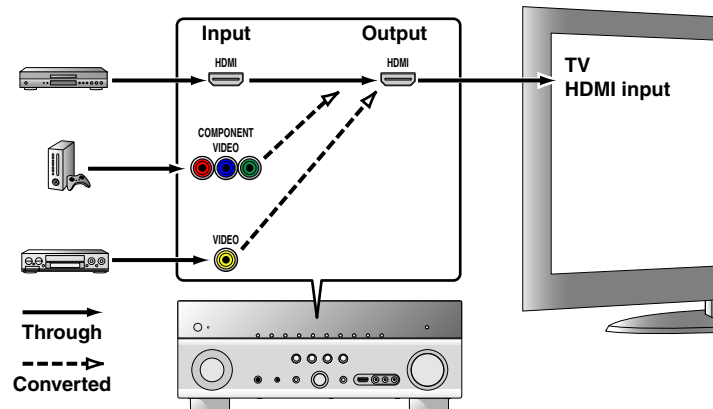

When connecting to a non-HDMI compatible TV

Connect to the TV using the same type of connection that you used to connect to the external component, and change the inputs on your TV to match that of the external component you are using for playback. If the external component and TV are equipped with different types of analog video jacks, this unit will convert the video signal to component video signal, or vice-versa, according to the type of video input jacks used by the TV. 🌟2, 🌟3

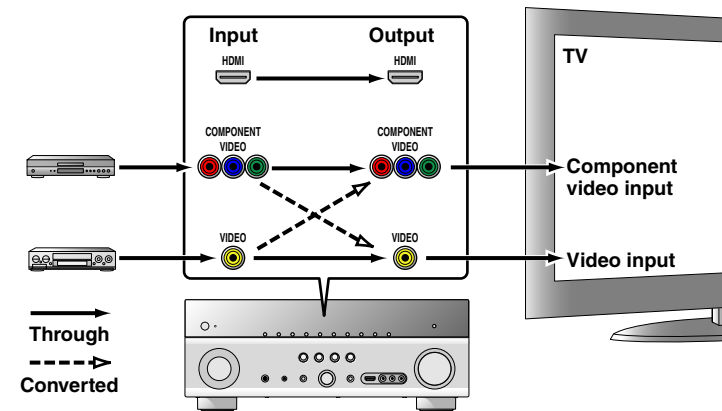

🌟 1 : You can change the resolution and aspect ratio when converting to HDMI to suit your requirements (see p. 85).

🌟 2 : Set "Analog to Analog Conversion" to "On" (see p. 84).

🌟 3 : Analog to analog conversion is available only for 480i/576i-resolution video signal.

■ Connecting an HDMI video monitor

Connect the HDMI cable to one of the HDMI OUT 1-2 jacks.

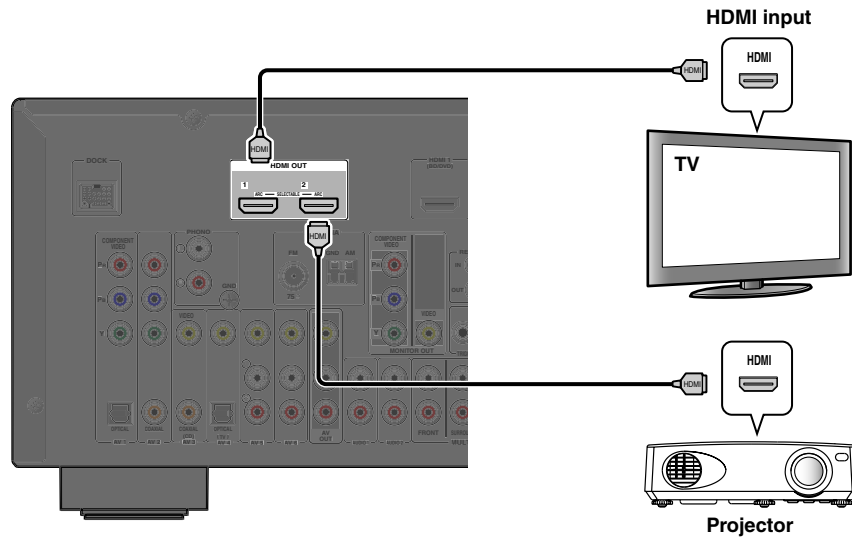

■ Connecting a component video monitor

Connect the component video cable to the COMPONENT VIDEO (MONITOR OUT) jacks.

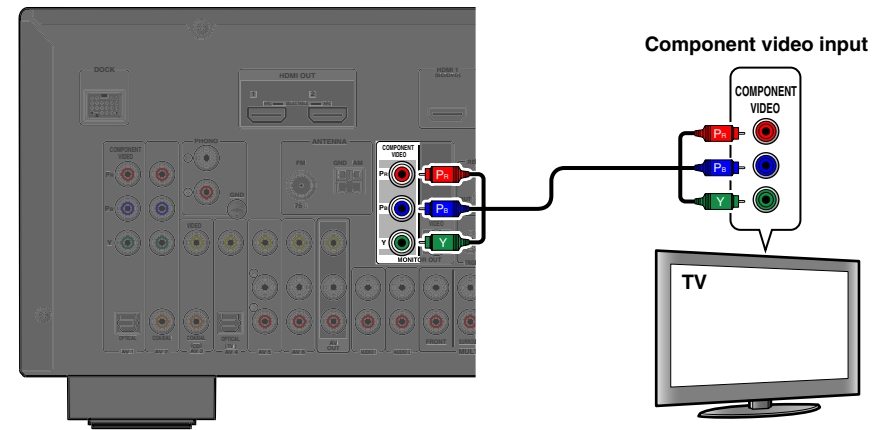

■ Connecting a video monitor

Connect the video pin cable to the VIDEO (MONITOR OUT) jack.

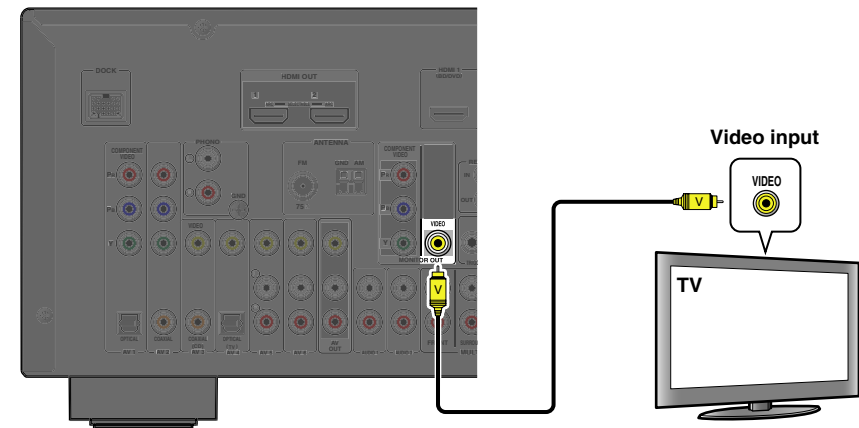

- Use a 19-pin HDMI cable with the HDMI logo.
- We recommend using a cable less than 5.0 m long to prevent signal quality degradation.
- When a TV that supports the HDMI function and Audio Return Channel function is connected, audio output from the TV can be input to this unit ([p. 101](#)).
- When a player and TV that support the 3D video format are connected to this unit, 3D content can be played back.
- This unit is equipped with HDMI OUT 1 and 2 jacks. The active HDMI OUT jack(s) can be selected ([p. 40](#)). The active HDMI OUT jack(s) can be registered with the SCENE function ([p. 42](#)).

 **1** : When connecting to a TV that supports HDMI input, the video signal for the COMPONENT VIDEO/VIDEO jacks is converted and output from HDMI OUT 1-2 jacks. When connecting to a TV via the HDMI jack, you do not need to use these jacks.

■ Listening to TV audio

To transmit sound from the TV to this unit, connect as followings according to the TV:

When using a TV that supports the Audio Return Channel function and HDMI Control function

When your TV supports both HDMI Control (e.g., Panasonic VIERA Link) and Audio Return Channel functions, audio/video output from the unit to the TV and audio output from the TV to the unit are possible using a single HDMI cable.

The input source is switched automatically to match operations carried out on the TV, and that makes TV sound control easier to use.

For the connections and settings, refer to “Single HDMI cable input to TV audio with Audio Return Channel function” ([p. 101](#)).

When using a TV that supports the HDMI Control functions

When using a TV that supports HDMI Control functions (e.g., Panasonic VIERA Link), if HDMI Control functions are enabled on the unit, then input source can be switched automatically to match operations carried out on the TV.

For the connections and settings, refer to “Switching the input source on this unit automatically when listening to TV audio” ([p. 100](#)).

When using other TVs

To transmit sound from the TV to this unit, connect AV1-6 or AUDIO1-2 jacks to the TV’s audio output jacks.

TV audio output	Connection
Optical digital audio output	Connect to the OPTICAL jack of the AV1 or AV4 with a fiber-optic cable.
Coaxial digital audio output	Connect to the COAXIAL jack of the AV2 or AV3 with a digital audio pin cable.
Analog stereo output	Connect to one of the AV5, AV6, AUDIO1, or AUDIO2 with a stereo pin cable.

Select the input source connected via TV’s audio output jack to enjoy the TV sound.

If the TV supports optical digital audio output, we recommend that you connect the TV audio output to the receiver’s AV4 jack.

Connecting to AV4 allows you to switch the input source to AV4 with just a single key operation using the SCENE function ([p. 42](#)).

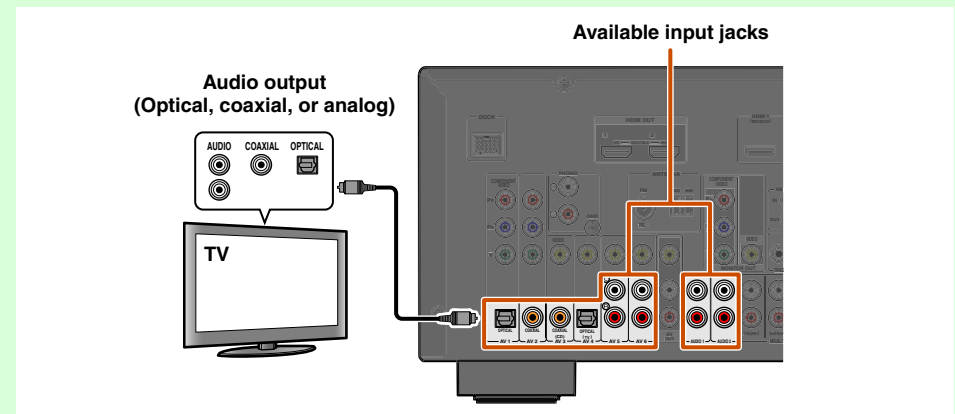

You can control your TV using the receiver’s remote control by entering the TV’s remote control code ([p. 94](#)).

Connecting BD/DVD players and other devices

This unit has the following input jacks. Connect them to the appropriate output jacks on the playback devices such as BD/DVD players.

Input	Video input	Audio input
HDMI1	HDMI	HDMI
HDMI2	HDMI	HDMI
HDMI3	HDMI	HDMI
HDMI4	HDMI	HDMI
HDMI5	HDMI	HDMI
AV1	Component video	Optical digital
AV2	Component video	Coaxial digital
AV3	Video	Coaxial digital
AV4	Video	Optical digital
AV5	Video	Analog (Stereo)
AV6	Video	Analog (Stereo)
AUDIO1	—	Analog (Stereo)
AUDIO2	—	Analog (Stereo)
VIDEO AUX	HDMI/Video	HDMI/Analog (Stereo)
PHONO	—	Analog (for turntable connection only)

Connecting BD/DVD players and other devices with HDMI

Connect the device with an HDMI cable to one of the HDMI1-5 jacks. The HDMI IN jack on the front panel can also be used.

Select the HDMI input (HDMI1-5 or VIDEO AUX) that the playback device is connected to for playback.

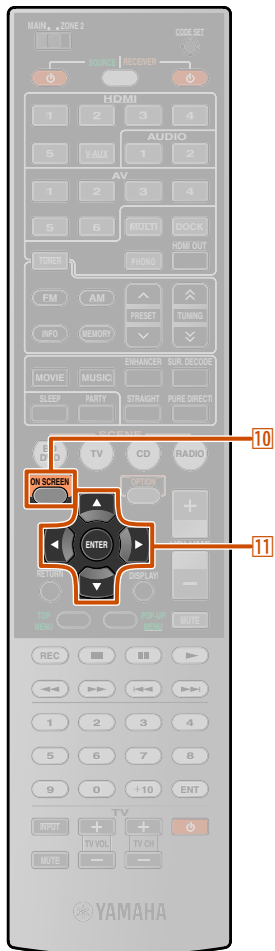

- 10 ON SCREEN
- 11 Cursor Δ / ∇ / \triangleleft / \triangleright
- 11 ENTER

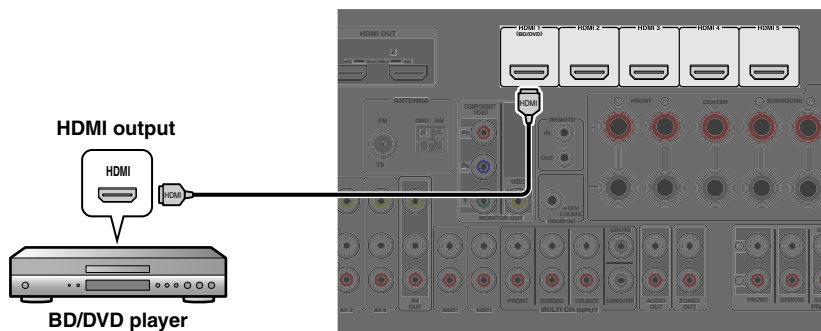

Receiving video signals from the HDMI jack and audio signals from a jack other than HDMI

This unit can use the AV1-6 or AUDIO1-2 input jacks to receive audio signals from other input jacks.

For example, if a playback device cannot produce audio signals from an HDMI jack, use the following method to change the audio input.

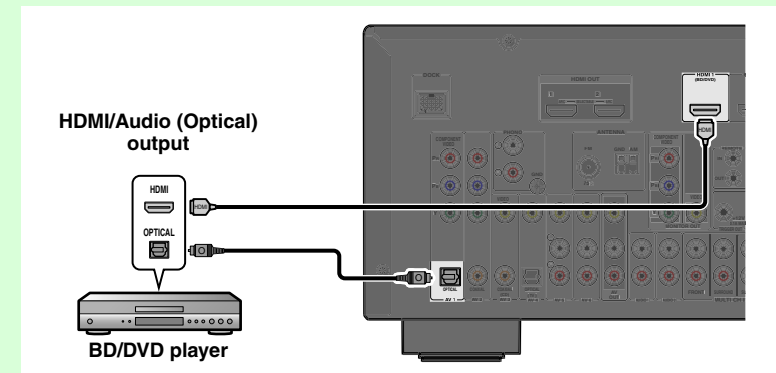

- 1 Press **10** ON SCREEN to display the ON SCREEN menu.
- 2 Press **11** Cursor Δ / ∇ repeatedly to select “Input,” and then press **11** ENTER.
- 3 Press **11** Cursor \triangleleft / \triangleright repeatedly to select the desired HDMI input source, and then press **11** Cursor Δ .
- 4 Press **11** Cursor ∇ repeatedly to select “Audio In,” and then press **11** ENTER.
- 5 Press **11** Cursor Δ / ∇ to select the audio input source.
- 6 Once you have completed the setup, press **10** ON SCREEN to close the menu.

1: Refer to the “Configuring input sources (Input menu)” ([*p. 66](#)) for details on selecting the input source.

■ Connecting BD/DVD players and other devices with component video cables

Connect the device with a component video cable to one of the AV1-2 input jacks.

Using optical digital audio output sources

Select the AV1 input to which the playback device is connected for playback.

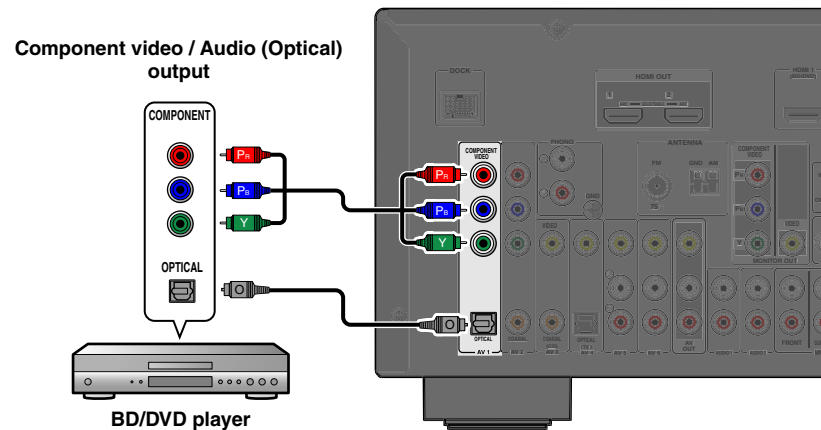

Using coaxial digital audio output sources

Select the AV2 input to which the playback device is connected for playback.

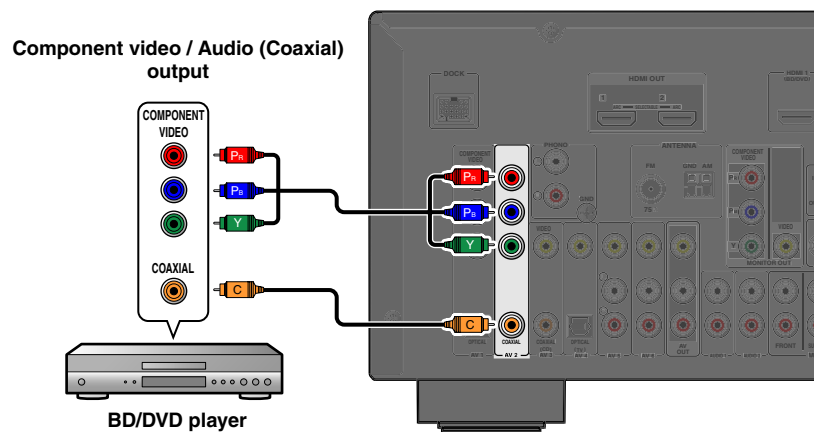

■ Component connections to analog audio output devices

Component video / Audio output

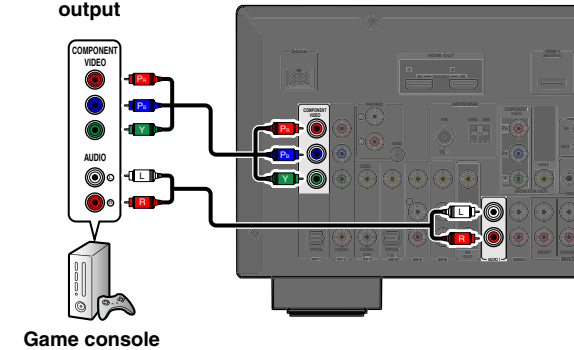

The video input from the AV1-2 jacks can be used in combination with the audio input from other AV inputs or AUDIO1-2.

When connecting these devices, select the AV input jacks or the AUDIO1-2 jacks as the audio input for AV1 or AV2. Refer to "Receiving video signals from the HDMI jack and audio signals from a jack other than HDMI" (p. 24) for detailed setup guidance.

For playback of the connected device, select the AV input source (AV1-2) to which the device is connected with the component video cable.

Connecting BD/DVD players and other devices with video cables

Connect the playback device with a video pin cable to one of the AV3-6 input jacks.

Using optical digital audio output sources

Select the AV4 input to which the playback device is connected for playback.

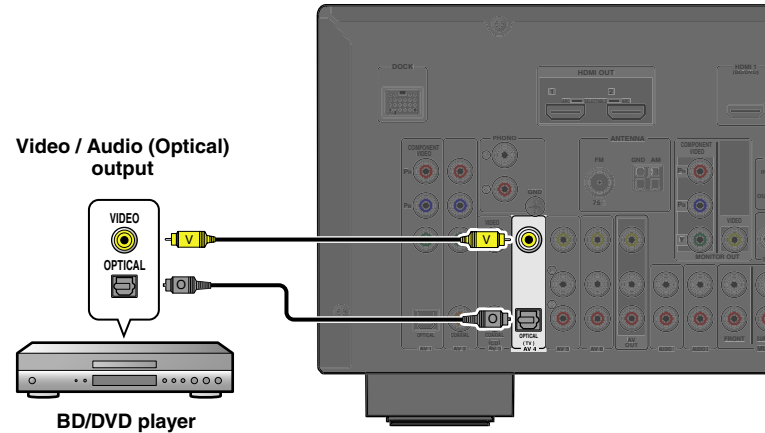

Using analog stereo audio output sources

Select the AV5 or AV6 input to which the playback device is connected for playback.

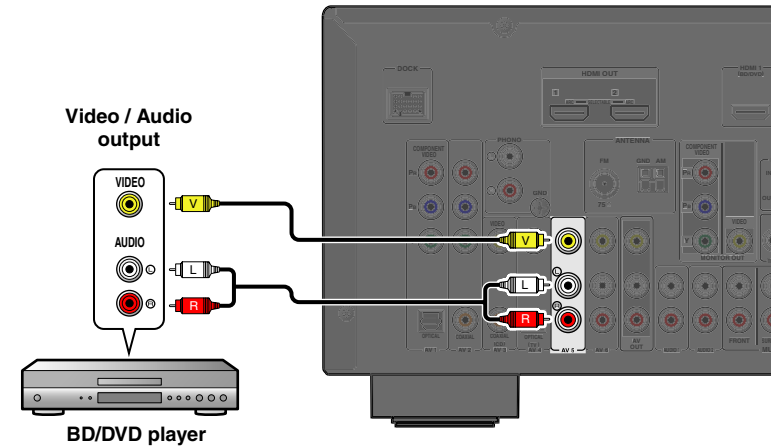

Using coaxial digital audio output sources

Select the AV3 input to which the playback device is connected for playback.

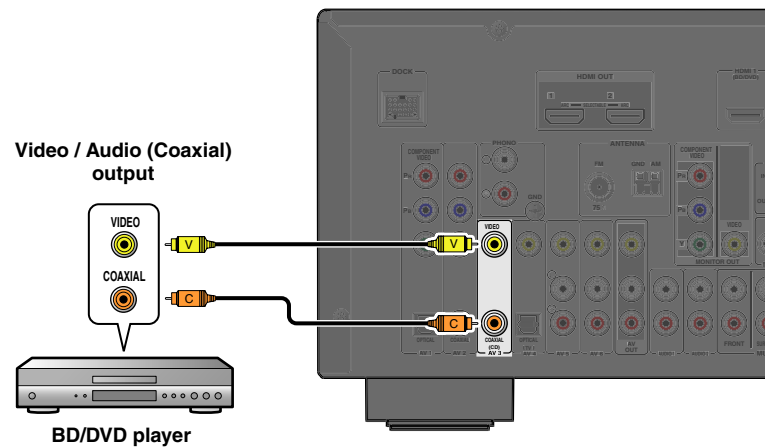

Connecting CD players and other audio devices

Using analog stereo output sources

Select the audio input (AUDIO1-2) to which the playback device is connected for playback.

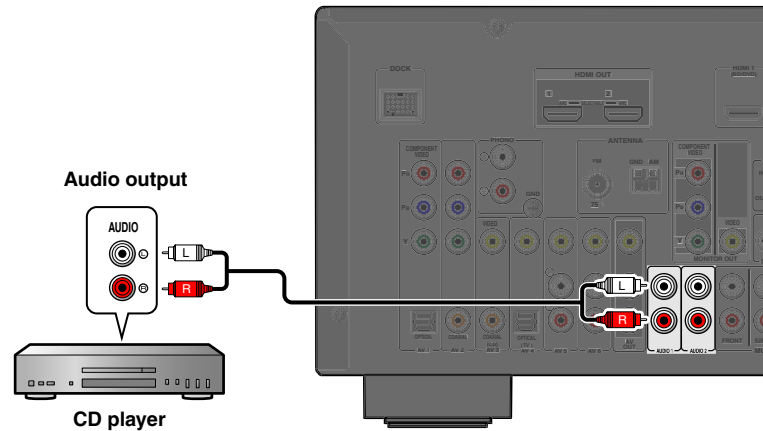

Using optical digital output sources

Select the AV input (AV1 or AV4) to which the playback device is connected for playback.

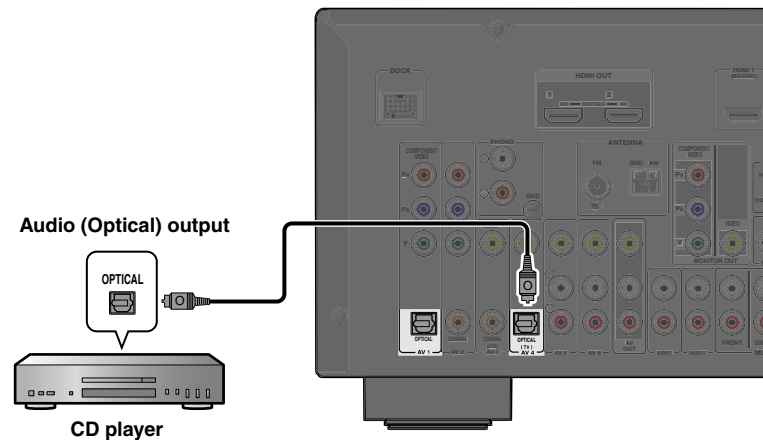

Using coaxial digital output sources

Select the AV input (AV2 or AV3) to which the playback device is connected for playback.

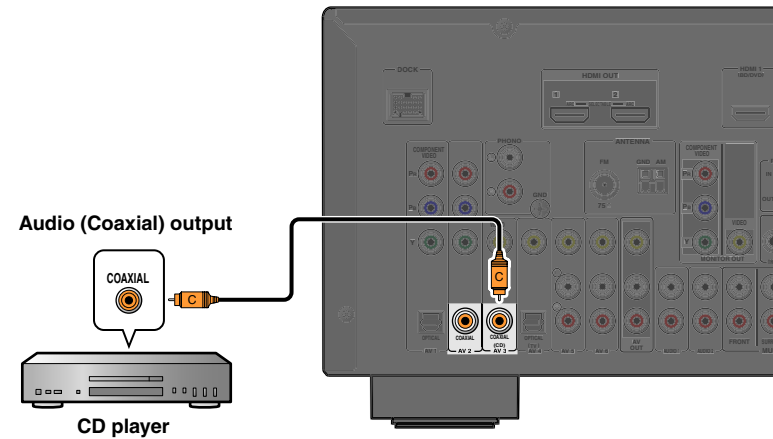

We recommend connecting audio devices with a coaxial digital output to the AV3 coaxial digital jack on this unit. This connection allows you to switch to the AV input 3 just by pressing the “CD” SCENE key (see p. 42).

Connecting a turntable

Connect the audio output of the turntable to PHONO jacks of this unit. 💡1

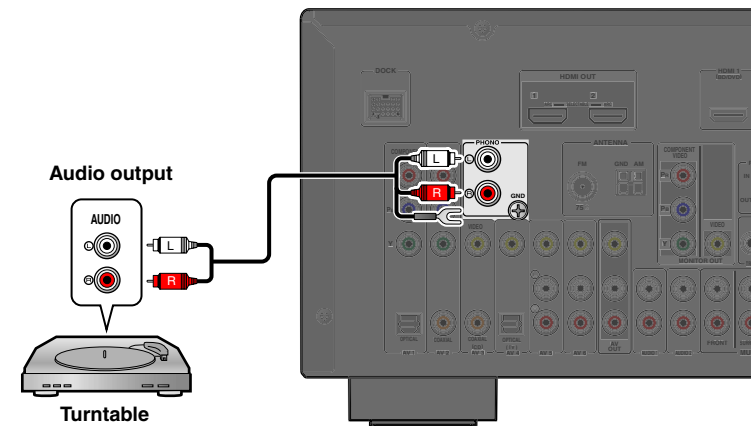

Connect your turntable to the GND terminal of this unit to reduce noise in the signal.

💡 1 : When connecting a turntable with a low-output MC cartridge to the PHONO jacks, use an in-line boosting transformer or MC-head amplifier.

Connecting game consoles

Use the VIDEO AUX jacks on the front panel to temporarily connect devices such as a game console to the receiver.

Select the V-AUX input to use these connected devices.

When connecting an HDMI compatible device

Connect the HDMI output of the device to the HDMI IN jack of this unit.

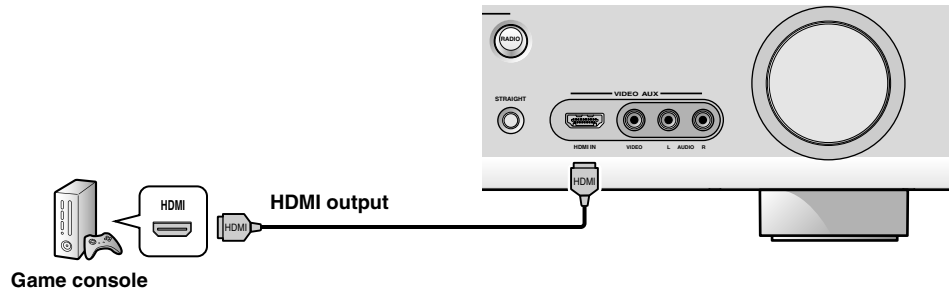

When connecting a non-HDMI compatible device

Connect the video and audio outputs of the device to the VIDEO and AUDIO jacks of this unit.

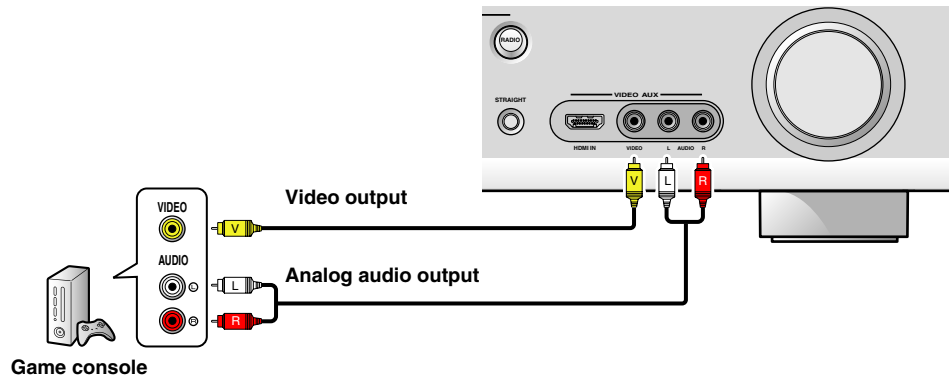

Connecting a multi-format player or an external decoder

This unit has 8 sets of input jacks (FRONT L/R, CENTER, SURROUND L/R, SUR. BACK and SUBWOOFER) to input multi-channel analog sound signals. If your playback component, such as a DVD player or SACD player, has multi-channel analog output capability, you can enjoy up to 7.1-channel multi-channel sound. To output multi-channel sound, connect the audio output jacks of your playback component to the MULTI CH INPUT jacks of this unit, and set the input source of this unit to “MULTI CH.”

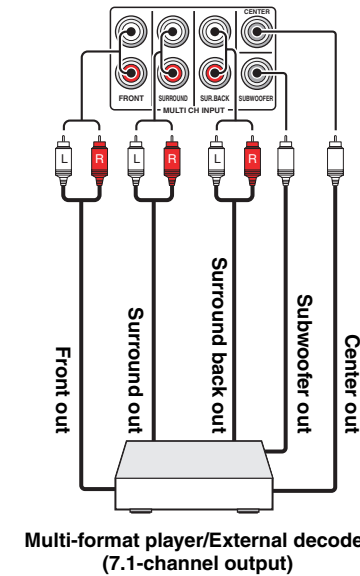

- When you select “MULTI CH” as the input source, the digital sound field processor and tone control are automatically disabled.
- Since this unit does not redirect signals input at the MULTI CH INPUT jacks to accommodate for missing speakers, connect at least a 5.1-channel speaker system when using this feature.
- When the input source is switched to “MULTI CH,” images input from a component connected to the HDMI1-5, AV1-6, or VIDEO AUX jacks can be displayed on a video monitor ([p. 69](#)). If your DVD player does not support multi-channel digital output, connect it to these input jacks.

- Be sure to turn down the volume when connecting this unit and the other devices.
- When both the HDMI connection and the analog video/audio connection are performed between the HDMI compatible device and this unit, only the HDMI signal will be input.

Connecting an external amplifier

The same channel signals are output from the jacks of the PRE OUT terminals as from their corresponding SPEAKERS terminals. When connecting an external power amplifier (pre-main amplifier) to enhance speaker output, connect the input terminals of the power amplifier to the PRE OUT terminals of this unit.

NOTE

When a component is connected to the PRE OUT terminals, do not connect speakers to the SPEAKERS terminals corresponding to those PRE OUT terminals.

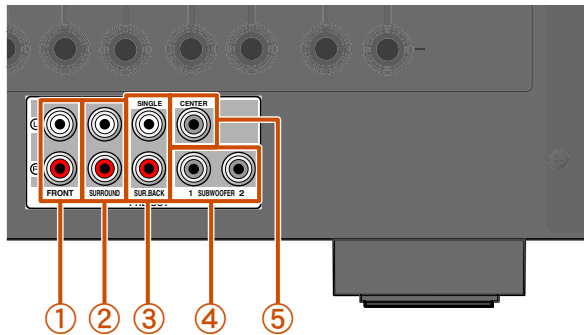

- ① **FRONT (PRE OUT) jacks**
Front channel output jacks.
- ② **SURROUND (PRE OUT) jacks**
Surround channel output jacks.
- ③ **SUR. BACK (PRE OUT) jacks**
Surround back output jacks. When you only connect one external amplifier for the surround back channel, connect it to the SUR. BACK (SINGLE) jack.
- ④ **SUBWOOFER (PRE OUT) 1/2 jack**
Connect a subwoofer with a built-in amplifier. When two subwoofers are connected, the same sound is output from them.
- ⑤ **CENTER (PRE OUT) jack**
Center channel output jack.

Connecting a SCENE link playback-compatible device

When the components are the Yamaha products and have the capability of the transmission of the remote control signals, connect the REMOTE IN and REMOTE OUT jacks to the remote control input and output jack with the monaural analog mini cable as follows.

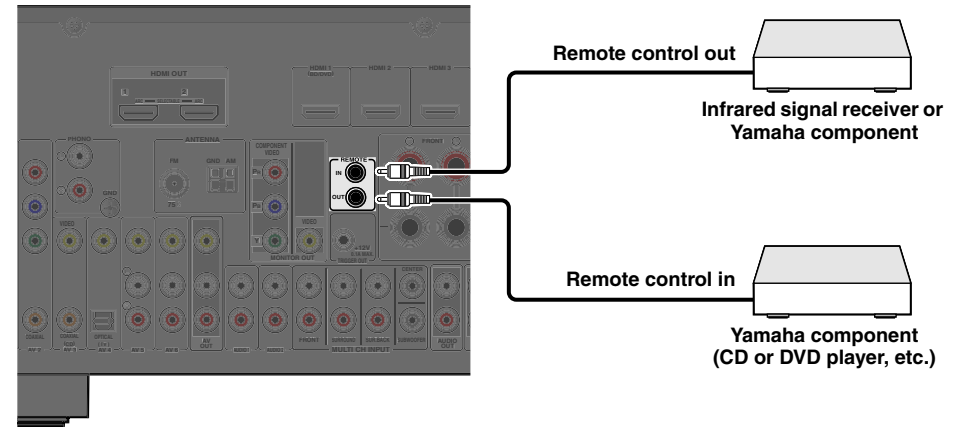

- When a Yamaha component that supports the SCENE link playback function is connected via the REMOTE OUT jack, playback begins automatically when the SCENE function is used (p. 42).
- If the component connected to the REMOTE OUT jack is not a Yamaha product, set “SCENE IR” in the SCENE menu to “Off” (p. 71).

Using the Trigger function to link external component power

When this unit is connected to a Yamaha subwoofer that supports the system connection or the component with TRIGGER IN jack, you can turn on and off the component by using this unit.

When connecting a Yamaha subwoofer

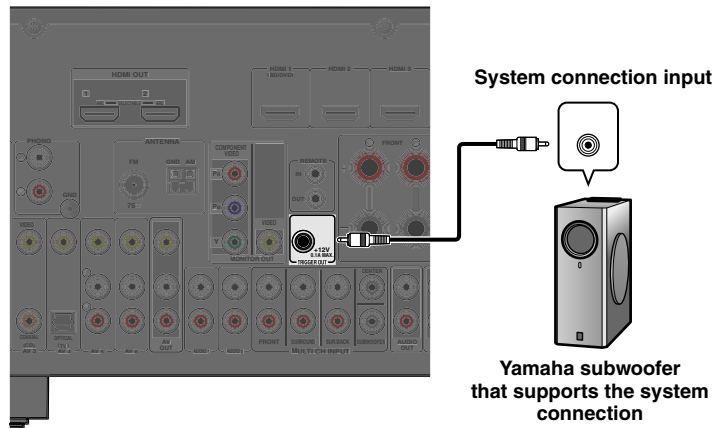

When connecting a component with the TRIGGER IN jack

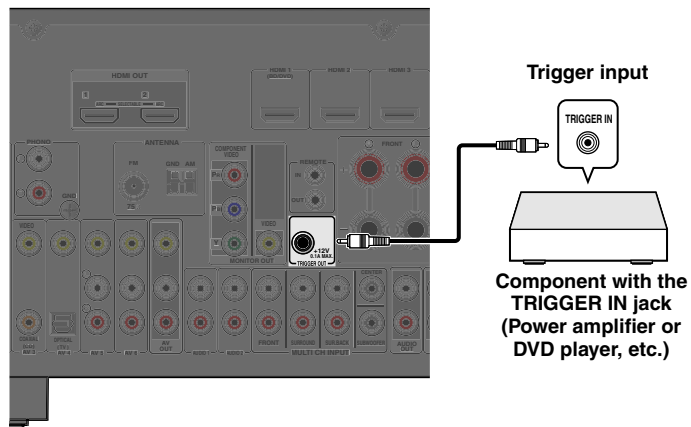

Connecting audio/video recording devices

This receiver can transmit selected incoming analog audio/video signals to external components through the AV OUT and AUDIO OUT jacks. You can record these input audio and video signals to VCRs or similar devices, or send them to other TVs or external components.

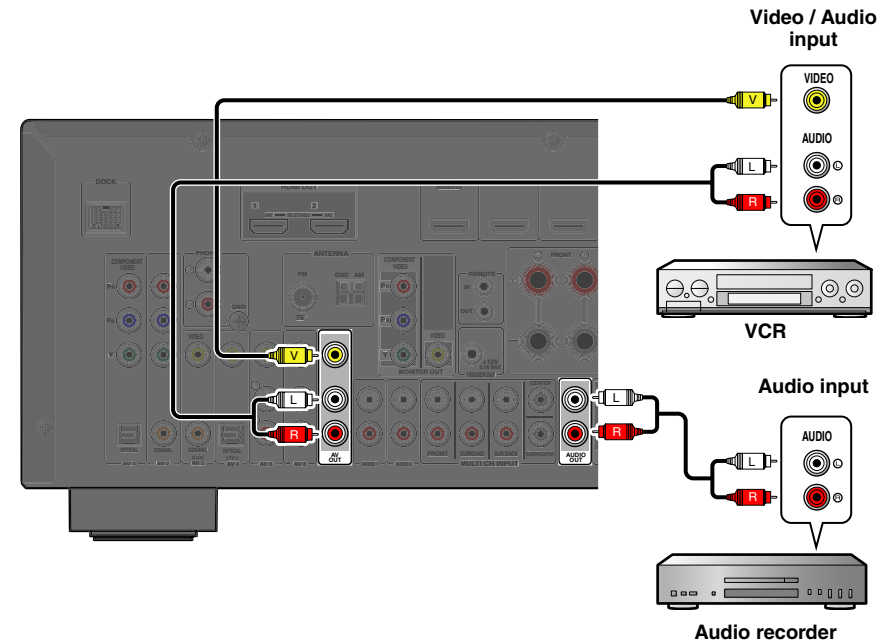

Using the AV OUT jacks

Connect this jacks to the external component's video input jack and analog audio input jacks.

Using the AUDIO OUT jacks

Connect this jack to the external component's analog audio input jacks.

HDMI audio/video signals, component video signals, and digital audio signals cannot be transmitted from these jacks.

Functions of the TRIGGER OUT jack can be specified ([p. 90](#)).

Connecting the FM/AM antennas

An indoor FM antenna and an AM loop antenna are supplied with this receiver. Connect these antennas properly to their respective jacks.

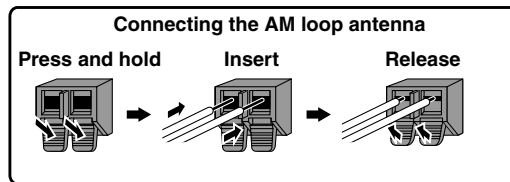
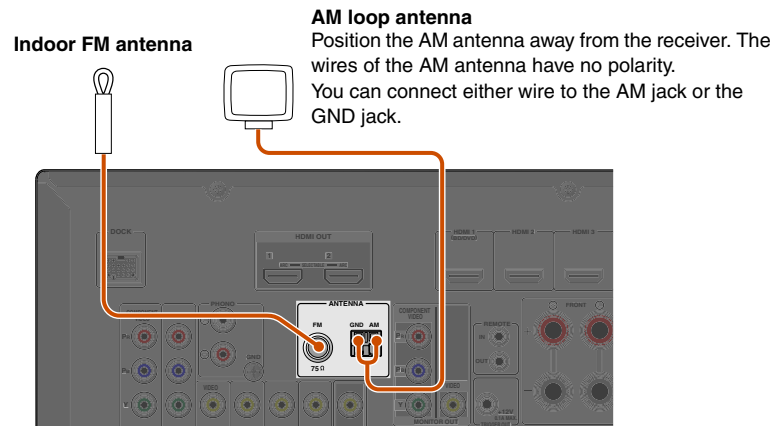

Assembling the AM loop antenna

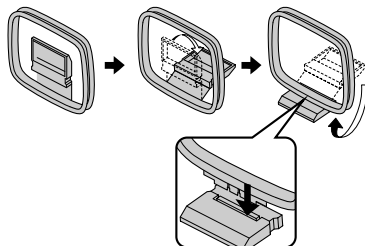

■ Improving FM reception

We recommend using an outdoor antenna. For more information, consult the nearest authorized dealer.

■ Improving AM reception

Connect this unit to an outdoor antenna with a 5 – 10 m vinyl-coated wire. Make sure the AM loop antenna is still connected.

Connecting the GND jack can reduce noise. Connect the jack to a store-bought ground bar or copper plate with a vinyl-covered wire and bury this new attachment in moist ground.

The GND jack is not to be connected to the ground socket of an electrical outlet.

Setting up the speaker parameters automatically (YPAO)

This unit is equipped with a Yamaha Parametric Room Acoustic Optimizer (YPAO) that adjusts the status, size, and volume balance of the speakers in order to provide an optimal sound field. Using YPAO allows you to automatically configure settings, such as adjusting speaker output and acoustic parameters to suit your listening room (the room in which this unit is placed). 🌟1

The amount of time for measurement varies from about two to ten minutes according to settings. Be aware of the following when using YPAO.

- The test tone is output at high volume. Refrain from using this function at night when it may be a nuisance to others.
- Take care that the test tone does not frighten small children.

YPAO operations can be viewed on the front panel display or TV screen.

1 Check the following before using YPAO.

This unit

- The headphones are removed.

TV

- This unit is connected to the TV correctly.
- The power is turned on.
- The video input to which the video output from this unit has been selected.

Subwoofer

- The power is turned on.
- Volume is set to approximately half, and the cross-over frequency (if present) is set to maximum.

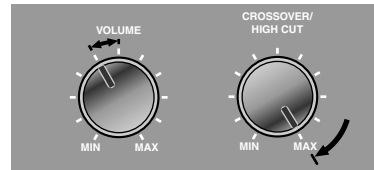

Subwoofer examples

2 Place the supplied YPAO microphone at ear height in your listening position.

Face the head of the YPAO microphone upwards.

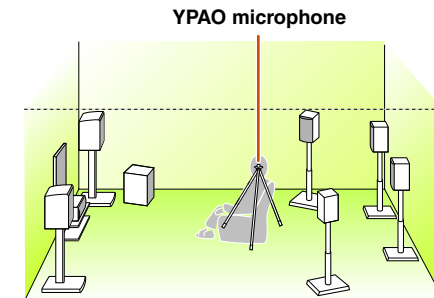

When positioning the microphone, we recommend that you use equipment that allows you to adjust the height (such as a tripod) as a microphone stand. When using a tripod, use the tripod screws to fix the microphone in place.

3 Switch this unit on.

Continues to the next page

🌟 1: When you have changed the number of speakers or the locations in which they are installed, first use YPAO to adjust the speaker balance.



11 Cursor Δ / ∇
11 ENTER

4 Connect the YPAO microphone to the YPAO MIC jack on the front panel.

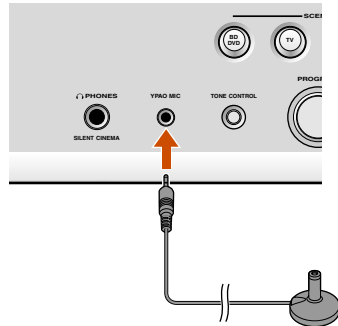

“Mic On. View ON SCREEN” appears on the front panel display, and the following display appears on the front panel display or TV screen.

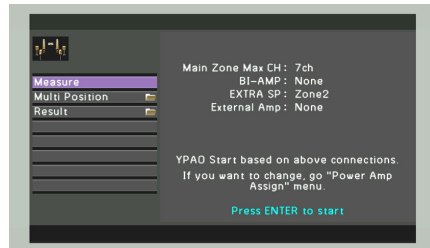

5 Press 11 Cursor Δ / ∇ to select the “Multi Position” and press 11 ENTER to set the number of listening positions to measure.

To measure at the multiple listening positions (up to 8), press 11 Cursor Δ / ∇ to select “Yes” and press 11 ENTER.

To measure at one listening position, press 11 Cursor Δ / ∇ to select “No” and press 11 ENTER.



“Multi Position” is set to “Yes” at initial factory settings. It is not necessary to perform step 5 when measuring at the multiple listening positions.

This completes preparation. To achieve more accurate results, take note of the following when measuring acoustics.

- It takes a few minutes to accurately measure acoustics for one position. Keep the room as quiet as possible while acoustics are measured.
- Wait in a corner of the room, or leave it entirely, while acoustics are measured to avoid creating an obstruction between the speakers and the YPAO microphone.

Continues to the next page





- 11 Cursor Δ / ∇
- 11 ENTER
- 11 RETURN

6 Press **11**Cursor Δ / ∇ repeatedly to select the “Measure” and press **11**ENTER to start measurement.

Auto measurement starts in 10 seconds.

- To start the measurement immediately, press **11**ENTER again.
- To cancel the automatic setup and return to the previous screen, press **11**RETURN and then **11**ENTER.

Display during measurement

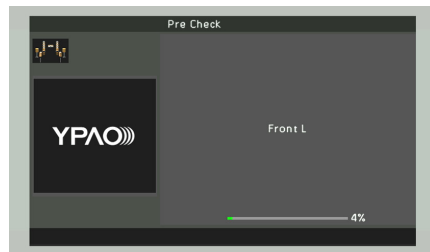

When “Multi Position” is set to “No” in step 5

The following display appears when measurement finishes without any problems.

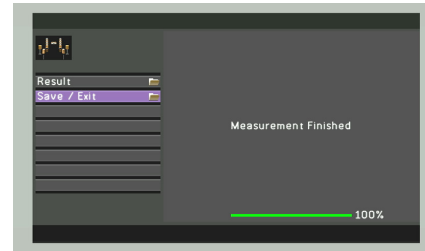

Go to step 8.

When “Multi Position” is set to “Yes” in step 5

The following display appears when measurement at the first position finishes without any problems.

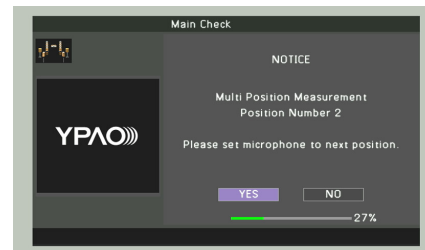

Go to step 7.

7 Replace the optimizer microphone at your choosing position and press **11**ENTER to restart the automatic measurement.

Auto measurement restarts in 10 seconds.

The following illustration shows how to place the optimizer microphone to optimize the setup of this unit for seven listening positions for example.

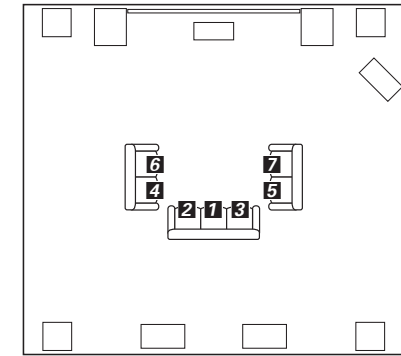

Repeat step 7 until the measurement at all listening positions are made.

Continues to the next page



11 Cursor Δ / ∇ / \triangleleft / \triangleright

11 ENTER

The following display appears again when measurement at the last position finishes without any problems.



NOTE

If a problem occurs, an error message or report is displayed either during or after acoustic measurement. Refer to “When an error message is displayed during measurement” ([p. 37](#)), or “When a warning message is displayed after measurement” ([p. 37](#)) to resolve the problem and measure acoustics with YPAO again.

Result	Displays the results of automatic acoustics measurement. Refer to “Reviewing and reloading automatic setup parameters” for details (p. 36).
Save/Exit	Applies the result to the speaker setup and finishes the automatic measurement.

8 Press 11 Cursor Δ / ∇ to select “Save/Exit” and press 11 ENTER.

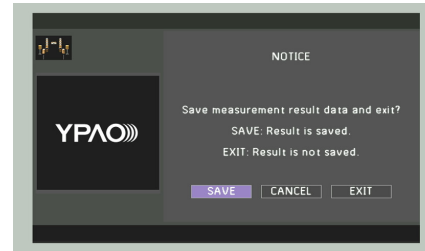

9 Press 11 Cursor \triangleleft / \triangleright to select “SAVE” and press 11 ENTER.

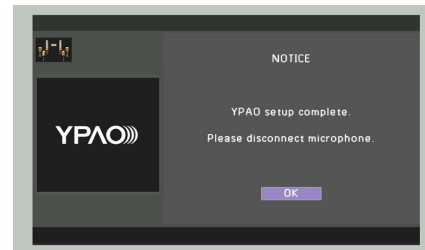

10 Press 11 ENTER. YPAO is automatically terminated. Disconnect the YPAO microphone.

The YPAO microphone is sensitive to heat. When you have finished measuring, store the microphone out of direct sunlight, and away from locations that may experience high temperatures, such as on top of AV equipment.





- 1** Cursor $\Delta / \nabla / \triangleleft / \triangleright$
- 1** ENTER
- 1** RETURN

1 Reviewing and reloading automatic setup parameters

The results of automatic acoustics measurement can be reviewed once measurement is complete. Automatic setup parameters can also be reloaded if you are not satisfied with manually configured speaker setup and sound adjustments.

NOTE
When automatic setup parameters are reloaded, manually configured settings are cleared. To save manually configured settings before reloading automatic setup parameters, see “Prohibiting setting changes” (p. 91).

1 Press **1**Cursor Δ / ∇ repeatedly to select “Result” and press **1**ENTER immediately after the automatic measurement.

The “Result” menu can also be viewed from the display shown after the YPAO microphone is connected.

The results of acoustics measurement are displayed.

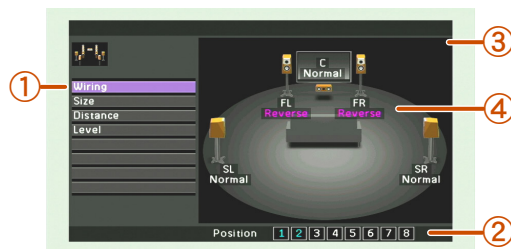

- 1** List of menu items
Menu items available in the Result menu are displayed.
- 2** Number of measurement
Indicates the number of measurements for multiple listening positions.

- 3** Diagram
Shows the speaker setup and sound adjustment as diagram.
- 4** Message
Displays warning or error messages.

2 Select the desired menu item (or enable a function) using **1**Cursor $\Delta / \nabla / \triangleleft / \triangleright$ and **1**ENTER.

3 Press **1**RETURN to finish “Result” menu.

Wiring	Displays the polarity of each connected speaker. • “Normal” is displayed when the polarity of the connected speaker is normal.
Size	Displays the size of the connected speakers. • “Large” is displayed when the connected speaker has the ability to reproduce the low-frequency signals effectively. • “Small” is displayed when the connected speaker does not have the ability to reproduce the low-frequency signals effectively.
Distance	Displays the distance from the listening position to speakers. The unit for distance can be switched between “ft” (feet) and “m” (meter) by pressing 1 Cursor $\triangleleft / \triangleright$.
Level	Displays the result of the adjustment of each connected speaker output level.
Setup Reload	Applies “Result” menu settings to this unit.





11 Cursor $\Delta / \nabla / \triangleleft / \triangleright$
11 ENTER

■ When an error message is displayed during measurement

See “Error messages” (p. 38) for instructions on resolving the problem and measure acoustics again.

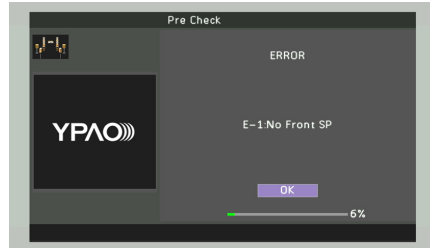

Check the error code displayed and use YPAO to measure acoustics again as described below.

11 When “E-1,” “E-2,” “E-3,” “E-4” or “E-6” is displayed

- 1** Press **11**ENTER.
- 2** Press **11**Cursor \triangleright to select “EXIT.”
- 3** Press **11**ENTER to terminate YPAO, and switch the unit to standby mode.
- 4** Check that the speakers are properly connected.
- 5** Turn on the unit and use YPAO again.

When “E-5,” “E-7,” “E-8” or “E-9” is displayed

- 1** Press **11**ENTER.
- 2** Check that the environment is suitable for accurate measurement.

- 3** Press **11**Cursor \triangleright to select “RETRY.”

- 4** Press **11**ENTER to use YPAO again.

When “E-10” is displayed

- 1** Press **11**ENTER.
- 2** Press **11**Cursor \triangleright to select “EXIT.”
- 3** Press **11**ENTER to terminate YPAO.
- 4** Switch the unit to standby mode.
- 5** Turn on the unit and use YPAO again.

■ When a warning message is displayed after measurement

See “Warning messages” (p. 39) for instructions on resolving the problem. The speaker causing the problem can be confirmed from the TV screen display.

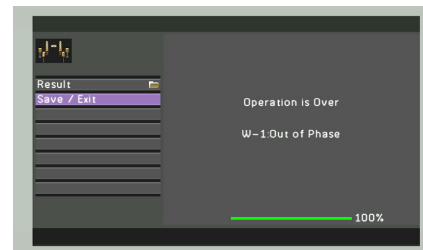

NOTE

Although the results of acoustics measurement can be applied when a warning message is displayed, optimal sound will not be achieved. Resolving the problem and using YPAO to measure acoustics again is recommended.

To exit YPAO with some options

- 1** Use **11**Cursor Δ / ∇ to select “Save/Exit” and press **11**ENTER.
- 2** Use **11**Cursor $\triangleleft / \triangleright$ to select one of the following options and press **11**ENTER.
 SAVE:
 Exits YPAO applying the results of measurement.
 CANCEL:
 Returns to the previous screen (warning message screen).
 EXIT:
 Exits YPAO without saving the results.

Message list

NOTE

If the following messages appear, resolve the problems that have occurred and carry out the measurement process again.

When a warning message is displayed before measurement

Connect MIC!	The YPAO microphone is not connected.	Connect the YPAO microphone to the YPAO MIC jack on the front panel.
Unplug HP!	The headphones are connected.	Remove the headphones.
Memory Guard!	The settings of this unit are protected.	Set "Memory Guard" in the Setup menu to "Off" (p. 91).

Error messages

E-1: No Front SP	The unit was not able to find the front channel.	Check that the left and right front speakers are connected correctly.
E-2: No Sur. SP	The unit was only able to find one of side of the surround channels.	Check that the left and right surround speakers are connected correctly.
E-3: No F.PRNS SP	The unit was only able to find one of side of the presence channels.	Check that the left and right presence speakers are connected correctly.
E-4: SBR→SBL	Only one surround back speaker is connected and only the right side surround back channel sound is detected.	When only one surround back speaker is connected, connect to the left side (SINGLE) terminal.
E-5: Noisy	The noise is too loud, preventing accurate measurements from being taken.	Measure again in quiet surroundings. Turn off any devices in the room that may be emitting noise, or place them further away from the YPAO microphone. When this message is displayed, selecting "PROCEED" will allow you to continue measuring. However, we recommend resolving the problem and measuring again, as continuing measurement without doing so will not give accurate results.
E-6: Check Sur.	Even though surround left and right speakers are not connected, only the surround back speakers are connected.	When using surround back speakers, connection of the surround left/right speakers is necessary.

E-7: No MIC	The YPAO microphone has been removed.	While measuring, take care not to touch the YPAO microphone.
E-8: No Signal	The YPAO microphone could not distinguish a test tone.	Check that the YPAO microphone has been installed correctly.
		Check that each speaker has been connected and installed correctly.
		The YPAO microphone or the YPAO MIC jack may be broken. Inquire at the retailer where you purchased this unit, or the nearest Yamaha service center.
E-9: User Cancel	You have carried out an operation that has cancelled the measuring process.	Carry out the measuring process again. Do not operate this unit by, for example, adjusting the volume.
E-10: Internal Error	An internal error has occurred.	Carry out the measuring process again. Contact a Yamaha service center if "E-10" is displayed again.



■ Warning messages

<p>W-1: Out of Phase</p>	<p>The speakers displayed are connected with the opposite polarity. Depending on the type of speakers you are using and the environment in which you have them installed, this message may occur even if the speakers are connected correctly.</p>	<p>Depending on the type of speakers, “W-1” may display even if the speakers are connected correctly.</p> <hr/> <p>Check that the speaker polarity + (positive), and - (negative) are correct. If these are connected correctly, you can use the speakers normally even this message appears.</p>
<p>W-2: Over 24m/80ft</p>	<p>The speakers displayed are separated from the listening position by more than 24 m, and cannot be adjusted correctly.</p>	<p>Install the speakers with 24 m of the listening position.</p>
<p>W-3: Level Error</p>	<p>Volume level varies greatly for individual channels, and cannot be adjusted correctly.</p>	<p>Check that all speakers are installed in the same surroundings.</p> <hr/> <p>Check that the speaker polarity + (positive), and - (negative) are correct.</p> <hr/> <p>We recommend the same speakers or speakers with as similar specifications as possible.</p> <hr/> <p>Adjust the volume of the subwoofer.</p>

If “W-2” or “W-3” appears, you can apply measurement results, but they will not give optimal results. We recommend that you resolve the problem and carry out the measurement process again.

PLAYBACK

Basic playback procedure

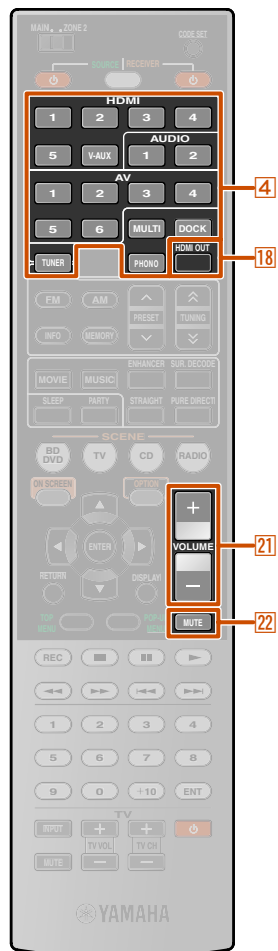

- 4 Input selector
- 18 HDMI OUT
- 21 VOLUME +/-
- 22 MUTE

1 Turn on external components (TV, DVD player, etc.) connected to this unit.

2 Use the **4** Input selector to select the input source.

The name of the selected input source is displayed for a few seconds. 1

When DOCK or TUNER is selected, the Content window is displayed ([p. 54](#)).

3 Play the external component that you have selected as the source input, or select a radio station on the tuner.

Refer to the instruction manuals provided with the external component for details on playback.

For details on the following operations, refer to the corresponding pages:

- “FM/AM tuning” ([p. 55](#))
- “Playing back tunes from your iPod™/iPhone™” ([p. 59](#))
- “Playing back tunes from Bluetooth™ components” ([p. 64](#))

4 Press **21** VOLUME +/- to adjust the volume.

To mute the output.

Press **22** MUTE to mute the audio output.

Press **22** MUTE again to unmute.

Selecting the active HDMI OUT jack

Use this function to select the HDMI OUT jack(s) used to output signal.

Press **18** HDMI OUT repeatedly to select setting.

The HDMI output setting changes as follows.



HDMI OUT 1+2	Outputs the signal at both the HDMI OUT 1 and HDMI OUT 2 jacks simultaneously.
HDMI OUT 1	Outputs the signals at the HDMI OUT 1 jack.
HDMI OUT 2	Outputs the signals at the HDMI OUT 2 jack.
HDMI OUT OFF	Any signals are not output at the HDMI OUT 1 and HDMI OUT 2 jacks. Select this setting when you do not use the video monitor connected to one of the HDMI OUT jacks.

- The HDMI OUT jack that utilizes the HDMI Control function can be selected with “Control Select” ([p. 86](#)).
- The active HDMI OUT jack(s) can be registered with the SCENE function ([p. 42](#)).

1 : You can change the input source name displayed on the front panel display as necessary ([p. 67](#)).

Adjusting high/low-frequency sound (Tone control)

You can adjust the balance of the high-frequency range (Treble) and low-frequency range (Bass) of sounds output from the front left and right speakers to obtain desired tone.

The tone control of the speakers or headphones can be set separately. Set the headphone tone control with the headphones connected.

- 1 Press **TONE CONTROL** on the front panel repeatedly to select “Treble” or “Bass.”

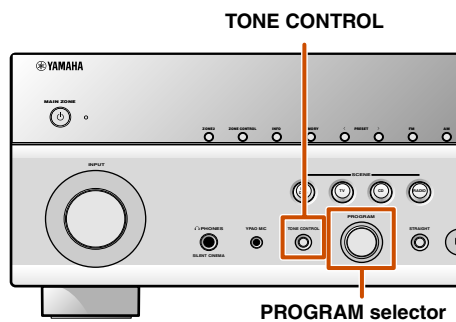

The current setting is displayed on the front panel display.



- 2 Rotate **PROGRAM** selector to adjust the output level in those frequency ranges.

Adjustable range	-6.0 dB to +6.0 dB
Adjustment increments	0.5 dB

The display returns to the previous display soon after you release the key.

- The tone control settings are not effective when this unit is in the Pure Direct mode or “MULTI CH” is selected as an input source.
- If you set the balance extremely off, sounds may not match those from other channels well.
- The tone control can also be adjusted in the OPTION menu ([p. 51](#)).

Changing input settings with a single key (SCENE function)

This unit has a SCENE function that allows you switch this unit on and change input sources, sound programs, and HDMI OUT with one key.

Four scenes are available for different uses, such as playing movies or music. The following input sources, sound programs, and HDMI OUT are provided as the initial factory settings.

SCENE	Input	Sound program	Compressed Music Enhancer mode	HDMI OUT
BD/DVD	HDMI1	Drama	Off	HDMI OUT 1+2
TV	AV4	STRAIGHT	On	HDMI OUT 1+2
CD	AV3	STRAIGHT	Off	HDMI OUT 1+2
RADIO	TUNER	STRAIGHT	On	HDMI OUT 1+2

Registering input sources/sound program/HDMI OUT

- Use the [4] **Input selector** to select the input source you want to register.
- Use the [19] **Sound selection keys** to select the sound program, Compressed Music Enhancer mode, or HDMI OUT you want to register.

- Press the [9] **SCENE** key until “SET Complete” appears on the front panel display.



Release the key when “SET Complete” is displayed

- When changing “SCENE,” also change the external component that the remote control operates (esp. 93).
- Selecting a scene and editing the scene function are also available in the SCENE menu (esp. 70).



- [4] **Input selector**
- [9] **SCENE**
- [19] **Sound selection keys**

Enjoying the desired sound field effect

This unit is also equipped with a Yamaha digital sound field processing (DSP) chip. Multi-channel playback from almost any audio source can be enjoyed using a variety of sound decoders and various sound field effect programs stored on the chip. Sound field effect programs built into this unit are called “sound programs.”

Selecting sound programs and sound decoders

This unit offers sound programs in many different categories suitable for movies, music and other uses. Choose a sound program that sounds best with the source you are playing back, rather than relying on the name or explanation of the program.

- Sound programs are stored for each input source. When you change the input source, the sound program previously selected for that input source is applied again.
- When you playback DTS Express sources or audio signals with sampling frequency of higher than 96 kHz, the straight decoding mode (esp. 43) is automatically selected.
- When you playback DTS-HD sources with CINEMA DSP, the DTS decoder is automatically selected.

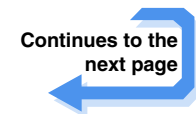



- [19] Sound selection keys**
- [19] MOVIE**
- [19] MUSIC**
- [19] ENHANCER**
- [19] SUR. DECODE**
- [19] STRAIGHT**
- [19] PURE DIRECT**

Selecting sound program (p. 46):
 MOVIE category: Press **[19]MOVIE** repeatedly
 MUSIC category: Press **[19]MUSIC** repeatedly

Selecting stereo reproduction:
 Press **[19]MUSIC** repeatedly

Selecting surround decoder:
 Press **[19]SUR. DECODE** repeatedly

Turning on Straight decoding mode:
 Press **[19]STRAIGHT**

Turning on Pure Direct mode (p. 45):
 Press **[19]PURE DIRECT**

Turning on Compressed Music Enhancer mode (p. 45):
 Press **[19]ENHANCER** repeatedly

Sound program categories



- You can use the speaker indicators on the front panel display to check what speakers are currently outputting sound (p. 10).
- You can adjust sound field elements (sound field parameters) for each of the programs (p. 73).

Enjoying unprocessed playback (Straight decoding mode)

Use straight decoding mode when you want to playback sound without sound field processing. You can playback as follows in straight decoding mode.

2-channel sources such as CD

Stereo sound plays through the front left and right speakers.

Multi-channel playback sources such as BD/DVD

Plays back audio from a playback source without applying sound field effects, using an appropriate decoder to split the signal into multiple channels.

Press **[19]STRAIGHT** to enable the straight decoding mode.



To disable straight decoding mode, press **[19]STRAIGHT** again.



Previously selected program

Enjoying stereo playback

Select “2ch Stereo” from the sound programs when you want to playback 2-channel stereo sound (from the front speakers only), regardless of the playback source. Selecting “2ch Stereo” will playback as follows for the playback of CD and BD/DVD sources.

2-channel sources such as CD

Stereo sound plays back through the front speakers.

Multi-channel sources such as BD/DVD

Playback channels other than the front channels in the playback source are mixed with the front channels and played back through the front speakers.

Press **[19]MUSIC** repeatedly to select “2ch Stereo.”



To disable stereo playback, press any of the **[19]Sound selection keys** to select a sound program other than “2ch Stereo.”

Enjoying sound programs without surround speakers

This unit allows you to use virtual surround speakers to enjoy sound field surround effects, even without any surround speakers (Virtual CINEMA DSP mode). You can even enjoy surround sound presence with just a minimal configuration of the front speakers only.

This unit will switch to Virtual CINEMA DSP mode automatically when surround speakers are unavailable. 🌟1

Enjoying sound programs with headphones

Even when headphones are connected, you can enjoy the reproduction sound field presence with ease (SILENT CINEMA mode). 🌟2

Enjoying more spatial sound fields (CINEMA DSP 3D mode)

CINEMA DSP 3D mode creates an intensive and accurate stereoscopic sound field in the listening room.

Connection of presence speakers is recommended to take full advantage of the effects of CINEMA DSP 3D mode. Do the following steps. 🌟3

- Connect the presence speakers to the EXTRA SP jacks and set the speakers to use (p. 14).
- Enable CINEMA DSP 3D in the OPTION menu (p. 51).

When a sound program runs in CINEMA DSP 3D mode, the CINEMA DSP 3D indicator on the front panel lights up.



Enjoying sound programs without presence speakers

This unit allows you to use virtual presence speakers to create an intensive and accurate stereoscopic sound field, even when no presence speakers are connected (Virtual CINEMA DSP 3D mode). You can even enjoy surround sound presence with front speakers, center speaker, and surround speakers.

This unit automatically switches to Virtual CINEMA DSP 3D mode when presence speakers are not available.

Do the following steps.

- Connect the front speakers, center speaker, and surround speakers.
- Enable center speaker and surround speakers in “Configuration” (p. 80).
- Enable CINEMA DSP 3D in the OPTION menu (p. 51).

🌟 1 : However, Virtual CINEMA DSP mode is not available under the following conditions:

- When headphones are connected to this unit.
- When a “7ch Stereo” or “2ch Stereo” sound program is selected.
- When Pure Direct mode or straight decoding mode is selected.

🌟 2 : However, SILENT CINEMA mode is not available under the following conditions:

- When a “2ch Stereo” sound program is selected.
- When Pure Direct mode or straight decoding mode is selected.

🌟 3 : However, CINEMA DSP 3D mode is not available under the following conditions:

- When headphones are connected to this unit.
- When a “7ch Stereo” or “2ch Stereo” sound program is selected.
- When Pure Direct mode or straight decoding mode is selected.

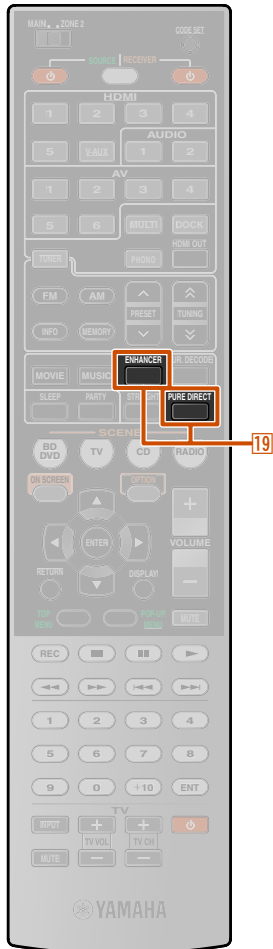

19 ENHANCER
19 PURE DIRECT

Enjoying Hi-Fi Sound Quality (Pure Direct mode)

Use Pure Direct mode to enjoy the pure high fidelity sound of the selected source. When Pure Direct mode is enabled, this unit plays back the selected source with the least circuitry. 

Press **19** **PURE DIRECT** to turn Pure Direct mode on. 

To disable Pure Direct mode, press **19** **PURE DIRECT** again.

Enjoying enhanced compression artifacts (Compressed Music Enhancer mode)

Compressed Music Enhancer mode improves the sound enhancer near to the original depth and width of compression artifacts. 

This mode can be used along with any other DSP modes.

Press **19** **ENHANCER** to turn Compressed Music Enhancer mode on.



To disable Compressed Music Enhancer mode, press **19** **ENHANCER** again.

 **1** : The following features are disabled in Pure Direct mode.

- sound program, tone control, YPAO PEQ, and Adaptive DRC
- displaying and operating the OPTION menu and Setup menu

 **2** : While Pure Direct mode is on, the front panel display screen turns off in order to reduce noise. When turning Pure Direct mode off, the screen returns on.

 **3** : However, Compressed Music Enhancer mode is not available in the following audio:







- Signals of which sampling rate is over 48kHz
- High Definition stream



Sound programs

 in the table indicates the sound program for CINEMA DSP.

Category: MOVIE







Sound programs optimized for viewing video sources such as movies, TV programs, and games.

Standard 	<p>This program creates a sound field emphasizing the surround feeling without disturbing the original acoustic positioning of multi-channel audio such as Dolby Digital and DTS. It has been designed with the concept of an ideal movie theater, in which the audience is surrounded by beautiful reverberations from the left, right and rear.</p>
Spectacle 	<p>This program represents the spectacular feeling of large-scale movie productions. It reproduces a broad theater sound field that matches cinemascope and wider-screen movies with an excellent dynamic range providing everything from very small sound effects to large, impressive sounds.</p>
Sci-Fi 	<p>This program clearly reproduces the finely elaborated sound design of the latest science fiction and special effects-featuring movies. You can enjoy a variety of cinematographically created virtual spaces reproduced with clear separation between dialog, sound effects and background music.</p>
Adventure 	<p>This program is ideal for precisely reproducing the sound design of action and adventure movies. The sound field restrains reverberations but puts emphasis on reproducing a powerful space expanded widely to the left and right. The reproduced depth is also restrained relatively to ensure the separation between audio channels and the clarity of the sound.</p>
Drama 	<p>This sound field features stable reverberations that match a wide range of movie genres from serious dramas to musicals and comedies. The reverberations are modest but offer an optimum 3D feeling, reproducing effects tones and background music softly but cubically around clear words and center positioning in a way that does not fatigue the listener even after long hours of viewing.</p>
Mono Movie 	<p>This program is provided for reproducing monaural video sources such as a classic movie in an atmosphere of a good old movie theater. The program produces the optimum expansion and reverberation to the original audio to create a comfortable space with a certain sound depth.</p>
Sports 	<p>This program allows the listeners to enjoy stereo sport broadcasts and studio variety programs with enriched live feeling. In sports broadcasts, the voices of the commentator and sportscaster are positioned clearly at the center while the atmosphere of the stadium expands in an optimal space to offer the listeners a feeling of presence in the stadium.</p>

Action Game 	<p>This sound field is suitable for action games such as car racing, fighting games and FPS games. The reality of, and emphasis on, various effects makes the player feel like they are right in the middle of the action, allowing for greater concentration.</p> <p>Use this program in combination with Compressed Music Enhancer mode for a more dynamic sound field.</p>
Roleplaying Game 	<p>This sound field is suitable for role-playing and adventure games. This program adds depth to the sound field for natural and realistic reproduction of background music, special effects and dialog from a wide variety of scenes.</p> <p>Use this program in combination with Compressed Music Enhancer mode for a more dynamic sound field.</p>
Music Video 	<p>This sound field offers an image of a concert hall for live performance of pop, rock and jazz music. The listener can indulge oneself in a hot live space thanks to the presence sound field that emphasizes the vividness of vocals and solo play and the beat of rhythm instruments, and to the surround sound field that reproduces the space of a big live hall.</p>







Category: MUSIC

This sound field is suitable when listening to music sources such as CDs.

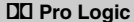
Hall in Munich 	This sound field simulates a concert hall with approximately 2500 seats in Munich, using stylish wood for the interior finishing as normal standards for European concert halls. Fine, beautiful reverberations spread richly, creating a calming atmosphere. The listener's virtual seat is at the center left of the arena.
Hall in Vienna 	This is an approximately 1700-seat, middle-sized concert hall with a shoebox shape that is traditional in Vienna. Pillars and ornate carvings create extremely complex reflections from all around the audience, producing a very full, rich sound.
Chamber 	This program creates a relatively wide space with a high ceiling like an audience hall in a palace. It offers pleasant reverberations that are suitable for courtly music and chamber music.
Cellar Club 	This program simulates a live house with a low ceiling and homey atmosphere. A realistic, live sound field features powerful sound as if the listener is in a row in front of a small stage.
The Roxy Theatre 	This is the sound field of a rock music live house in Los Angeles, with approximately 460 seats. The listener's virtual seat is at the center left of the hall.
The Bottom Line 	This is the sound field at stage front in The Bottom Line, a famous New York jazz club once. The floor can seat 300 people to the left and right in a sound field offering real and vibrant sound.
2ch Stereo	Use this program to mix down multi-channel sources to 2-channels. When multi-channel signals are input, they are down mixed to 2-channels and output from the front left and right speakers.
7ch Stereo 	Use this program to output sound from all speakers. When you playback multi-channel sources, this unit down-mixes the source to 2-channels, and then outputs the sound from all speakers. This program creates a larger sound field and is ideal for background music at parties, etc.

Category: SUR.DEC (Surround decode mode)

Select this program to playback sources with selected decoders. You can playback 2-channel audio sources in up to 7-channels using a surround decoder.

 Pro Logic	Reproduces sound using the Dolby Pro Logic decoder. This is suitable for all kinds of audio sources.
 PLIIx Movie /  PLII Movie	Reproduces sound using the Dolby Pro Logic IIx (or Dolby Pro Logic II) decoder. This is suitable for movies. 🌟1
 PLIIx Music /  PLII Music	Reproduces sound using the Dolby Pro Logic IIx (or Dolby Pro Logic II) decoder. This is suitable for music. 🌟1
 PLIIx Game /  PLII Game	Reproduces sound using the Dolby Pro Logic IIx (or Dolby Pro Logic II) decoder. This is suitable for games. 🌟1
Neo:6 Cinema	Reproduces sound using the DTS Neo:6 decoder. This is suitable for movies.
Neo:6 Music	Reproduces sound using the DTS Neo:6 decoder. This is suitable for music.

🌟1: You cannot select the Dolby Pro Logic IIx decoder in the following conditions:

- When "Surround Back" is set to "None" (see p. 80).
- When headphones are connected.

Using the TV display to control this unit

This unit features a sophisticated on-screen display (OSD) that helps you to control the amplifier function of this unit. With the OSD, you can view information of the signals being input and the status of this unit. Visual guidance simplifies operations for menus.

Basic operations via the TV screen display

A TV screen is required to display the ON SCREEN or OPTION menu. Refer to “Connecting a TV monitor” for instructions on connecting a TV screen ([p. 21](#)).

This section describes basic operations for configuring “Input,” “Scene” and “Sound Program” using the OSD.

Press **10 ON SCREEN**.

The ON SCREEN menu is displayed on the TV screen.

Selecting an input source

1 Use **11 Cursor** Δ / ∇ to select “Input” and press **11 ENTER**.

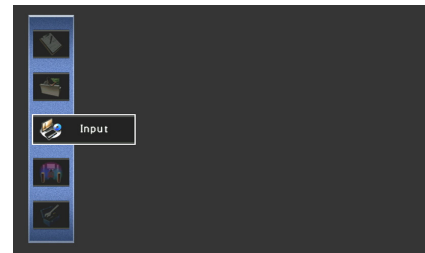

Input source icons are displayed at the bottom of the TV screen.

2 Use **11 Cursor** \leftarrow / \rightarrow to select a Input source press **11 ENTER**.

The input source is selected.

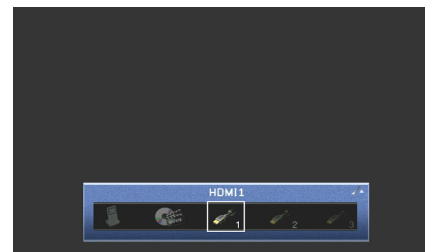

- Pressing **11 RETURN** displays the previous menu screen. Press **11 RETURN** repeatedly to close the ON SCREEN menu.
- In addition to selecting an input source, detailed settings for each input source can be configured. Refer to “Configuring input sources (Input menu)” ([p. 66](#)) for details.

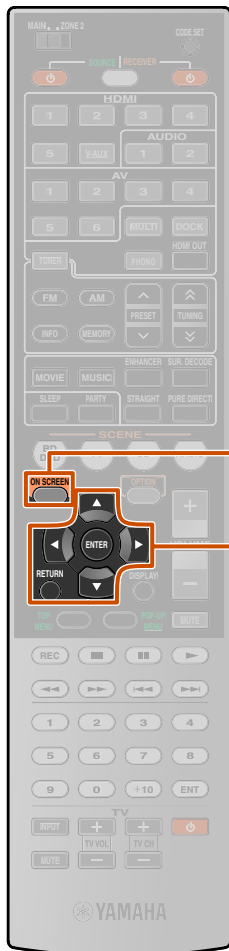

10 ON SCREEN

11 Cursor $\Delta / \nabla / \leftarrow / \rightarrow$

11 ENTER

11 RETURN



- 1** Cursor $\Delta / \nabla / \triangleleft / \triangleright$
- 1** ENTER
- 1** RETURN

1 Selecting a scene

- 1** Use **1**Cursor Δ / ∇ to select “Scene” and press **1**ENTER.

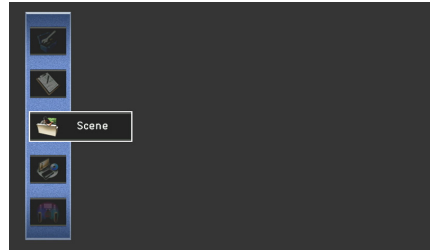

Scene icons are displayed at the bottom of the TV screen.

- 2** Use **1**Cursor $\triangleleft / \triangleright$ to select a scene and press **1**ENTER.

The scene is selected.

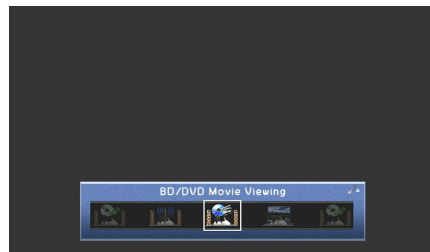

- Pressing **1**RETURN displays the previous menu screen. Press **1**RETURN repeatedly to close the ON SCREEN menu.
- Refer to “Changing input settings with a single key (SCENE function)” ([p. 42](#)) for details on the default scene settings.
- Detailed SCENE function settings can be edited. Refer to “Editing the SCENE function (SCENE menu)” ([p. 70](#)) for details.

1 Selecting a sound program

- 1** Use **1**Cursor Δ / ∇ to select “Sound Program” and press **1**ENTER.

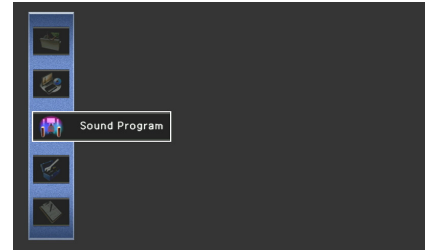

Sound program icons are displayed at the bottom of the TV screen.

- 2** Use **1**Cursor $\triangleleft / \triangleright$ to select a sound program and press **1**ENTER.

The sound program is selected.

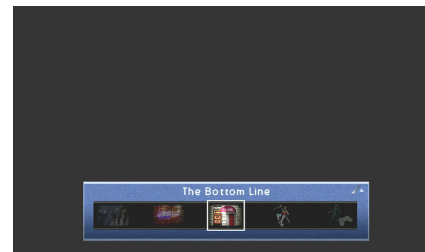

- Pressing **1**RETURN displays the previous menu screen. Press **1**RETURN repeatedly to close the ON SCREEN menu.
- Refer to “Enjoying the desired sound field effect” ([p. 42](#)) for various sound programs.
- You can configure the detailed settings for each sound program. Refer to “Setting sound program parameters (Sound Program menu)” ([p. 73](#)) for details.

NOTES

Menus can be operated and the status of this unit confirmed from the following three main displays.

- ON SCREEN menu ([p. 66](#))
- OPTION menu ([p. 50](#))
- Content window ([p. 54](#))

These menus and status features can be used to configure more various functions in addition to selecting “Input,” “Scene” and “Sound Program.” Refer to each reference for details on menus and status.

Configuring settings specific to an individual input source (OPTION menu)

This unit has a unique OPTION menu for each input source. OPTION menus can be used to enable features such as volume trim for compatible input sources or to display audio/video data.

OPTION menu display and setup

OPTION menu operations are displayed on the front panel display or TV screen. TV display is used here to explain operation.

1 Use **[4]** Input selector to select an input source to which options will be applied.

2 Press **[20]** OPTION.
The OPTION menu is displayed.

OPTION menu



The displayed OPTION menu settings differ depending on the input source.

For more information, refer to the “OPTION menu” on the next page.

3 Use **[11]** Cursor Δ / ∇ to select the desired setting and press **[11]** ENTER.

Parameters of the selected item are displayed.

4 Use **[11]** Cursor $\Delta / \nabla / \triangleleft / \triangleright$ to select the desired item (or enable a function).

- Press **[11]** RETURN to display the previous screen or close the OPTION menu.
- The OPTION menu may close automatically when some functions are enabled.

5 Press **[20]** OPTION to close the OPTION menu.

The keys on the remote control may not respond for a few seconds after the OPTION menu is closed. Should this occur, select the input source again.

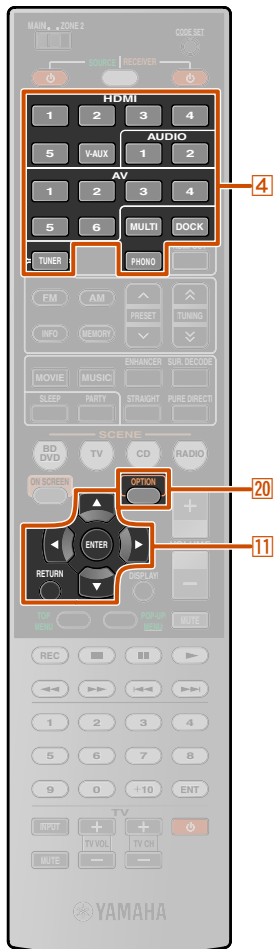

- [4]** Input selector
- [11]** Cursor $\Delta / \nabla / \triangleleft / \triangleright$
- [11]** ENTER
- [11]** RETURN
- [20]** OPTION

OPTION menu

The following items are provided for each input source. 🌟1

HDMI1-5	Tone Control	Adaptive DRC	CINEMA DSP 3D Mode
	Dialogue Lift 🌟2	Extended Surround	Volume Trim
AV1-4	Tone Control	Adaptive DRC	CINEMA DSP 3D Mode
	Dialogue Lift 🌟2	Extended Surround	Volume Trim
AV5-6	Tone Control	Adaptive DRC	CINEMA DSP 3D Mode
	Dialogue Lift 🌟2	Volume Trim	
AUDIO1-2	Tone Control	Adaptive DRC	CINEMA DSP 3D Mode
	Dialogue Lift 🌟2	Volume Trim	
V-AUX	Tone Control	Adaptive DRC	CINEMA DSP 3D Mode
	Dialogue Lift 🌟2	Extended Surround	Volume Trim
PHONO	Tone Control	Adaptive DRC	CINEMA DSP 3D Mode
	Dialogue Lift 🌟2	Volume Trim	
TUNER	Tone Control	Adaptive DRC	CINEMA DSP 3D Mode
	Dialogue Lift 🌟2	Volume Trim	

DOCK (iPod)	Tone Control	Adaptive DRC	CINEMA DSP 3D Mode
	Dialogue Lift 🌟2	Volume Trim	Shuffle 🌟3
	Repeat 🌟3		
DOCK (Bluetooth)	Tone Control	Adaptive DRC	CINEMA DSP 3D Mode
	Dialogue Lift 🌟2	Volume Trim	Pairing
	Connect/Disconnect		
MULTI CH	Volume Trim		

Adjusting high/low-frequency sound

Tone Control

Input source: All input sources except MULTI CH

You can adjust the balance of the high-frequency range (Treble) and low-frequency range (Bass) of sounds output from the front left and right speakers to obtain desired tone.

Adjustable range	-6.0 dB to +6.0 dB
Adjustment increments	0.5 dB

- The tone control of the speakers or headphones can be set separately. Set the headphone tone control with the headphones connected.
- TONE CONTROL on the front panel can also be used (p. 41).

🌟1: When “Tone Control,” “Adaptive DRC,” “CINEMA DSP 3D Mode,” “Dialogue Lift,” or “Extended Surround” is adjusted for an input source, the same value is applied to other input sources and “ALL” is displayed on the front panel display. When settings specific to a certain input source are selected, the input source name is displayed on the front panel display. If the name of the input source has been changed (p. 67), the original name of the

input source is displayed.

🌟2: “Dialogue Lift” can be adjusted only when the presence speakers are available.

🌟3: Not available for Yamaha iPod wireless receiver.

Auto-adjusting the sound level to make even low volumes more audible

Adaptive DRC

Input source: All input sources except MULTI CH

Adjusts the dynamic range in conjunction with the volume level (from minimum to maximum). When you play audio at night or at low volumes, it is a good idea to set parameter to “On.” 

On	Adjusts the dynamic range automatically.
Off (Default)	Does not adjust the dynamic range automatically.

When “On” is selected, the dynamic range is adjusted as follows.

If the volume level is low, the dynamic range is narrow.
If the volume level is high, the dynamic range is wide.

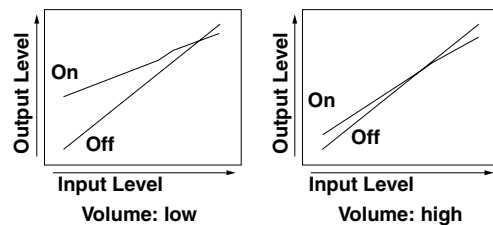

Enjoying more spatial sound fields

CINEMA DSP 3D Mode

Input source: All input sources except MULTI CH

When CINEMA DSP 3D is enabled, set whether to use sound programs in CINEMA DSP 3D mode ([p. 44](#)).

Adjusts the vertical position of dialogues

Dialogue Lift

Input source: All input sources except MULTI CH

Adjusts the vertical position of center sound such as dialogues when presence speakers are used. Increasing this parameter raises the position.

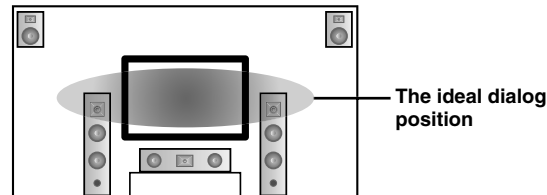

If the dialog seems to come out from a lower position than the video monitor screen, increase this parameter.

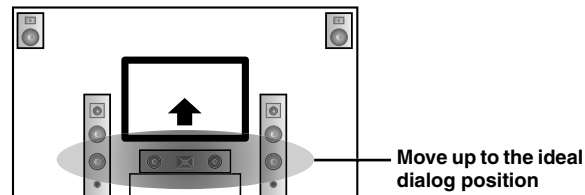

“0” (default) corresponds to the lowest position and “5” to the highest position.

- “Dialogue Lift” can be adjusted only when the presence speakers are available.
- You cannot move the dialog position lower than the default setting.

Selecting the 5.1-channel signal playback method

Extended Surround

Input source: HDMI1-5, AV1-4, V-AUX 

Selects whether to reproduce 5.1-channel input signals in 6.1- or 7.1-channel when surround back speakers are used.

Auto (Default)	Automatically selects the most suitable decoder if a flag for reproducing surround back channel is present, and reproduces the signals in 6.1- or 7.1-channel.
<input checked="" type="checkbox"/> PLIIx Movie	Always reproduces signals in 7.1-channel using the Dolby Pro Logic IIx Movie decoder whether or not surround back channel signals are contained. You can select this parameter when two surround back speakers are connected.
<input checked="" type="checkbox"/> PLIIx Music	Always reproduces signals in 6.1- or 7.1-channel using the Dolby Pro Logic IIx Music decoder whether or not surround back channel signals are contained. You can select this parameter when one or two surround back speakers are connected.
EX/ES	Automatically selects the most suitable decoder for input signals whether or not the flag for reproducing surround back channel is present, and always reproduces signals in 6.1-channel.
Off	Always reproduces original channels whether or not the flag for reproducing surround back channel is present.

 1: “Adaptive DRC” is also effective when you use headphones.

 2: AV5-6 or AUDIO1-2 are also available when “Audio Return Channel” is on, and the input source is used for “TV Audio Input.”

Adjusting volume between input sources

Volume Trim

Input source: All

Reduces any change in volume when switching between input sources by correcting volume differences in each input source. You can adjust this parameter for each input source.

Adjustable range	-6.0 dB to 0.0 dB to +6.0 dB
Default setting	0.0 dB
Adjustment increments	0.5 dB steps

Shuffle playback with iPod/iPhone

Shuffle

Input source: DOCK (iPod)  1



Plays back songs or albums in random order. When the shuffle function is enabled, “” appears on the TV screen.

Off	The shuffle function is turned off.
Songs	Plays songs back in random order.
Albums	Plays albums back in random order.

Repeat playback with iPod/iPhone

Repeat

Input source: DOCK (iPod)  1

Plays songs or albums repeatedly. When the repeat function is enabled, “ (One)” or “ (All)” appears on the TV screen.

Off	The repeat function is turned off.
One	Plays a song back repeatedly.
All	When all songs have completed playback, returns to the start and repeats playback.

Connect / Disconnect Bluetooth component

Connect

Disconnect

Input source: DOCK (Bluetooth)

Switches communication with a Bluetooth component on and off ([p. 64](#)).

Pairing Bluetooth component

Pairing

Input source: DOCK (Bluetooth)

Performs pairing of this unit and a Bluetooth component ([p. 64](#)).

 1: Not available for Yamaha iPod wireless receiver.

Confirming and operating input sources from the Content window

When DOCK or TUNER is selected, the Content window is displayed on the TV screen. Playback style for iPod and functions for FM/AM tuner can be set in the Content window.

A TV screen is required to display the Content window. Refer to “Connecting a TV monitor” for instructions on connecting a TV monitor (p. 21).

Displaying the Content window on the TV screen

Press **4**DOCK or **4**TUNER to display the Content window.

The Content window consists of two main displays, the Now Playing view and the Content browse view.

Below is the example of the Now playing view for TUNER.

③ Screen button area



Buttons to operate each input source are displayed here. These buttons vary depending on the selected input. For details on operations for each input, see the following.

- FM/AM tuner (p. 57)
- iPod (p. 60)

- In the Now playing view, press **11**ENTER and use **11**Cursor Δ / ∇ to select the button. Then press **11**ENTER to execute the selection.
- In the Content browse view, press **11**Cursor \triangleright and use **11**Cursor Δ / ∇ to select the button. Then press **11**ENTER to execute the selection.
- Press **11**RETURN repeatedly to exit from the operation.

Switching the display between the Now Playing view and the Content browse view

You can switch the display between the Now Playing view and the Content browse view by the following methods.

- Press **12**DISPLAY to cycle between the Now Playing view and the Content browse view.
- In the Now Playing view, press **11**ENTER and use **11**Cursor Δ / ∇ to select the  icon. Then press **11**ENTER to switch to the Content browse view.
- In the Content browse view, press **11**Cursor \triangleright and use **11**Cursor Δ / ∇ to select the  icon. Then press **11**ENTER to switch to the Now Playing view.

Content browse view



Now playing view

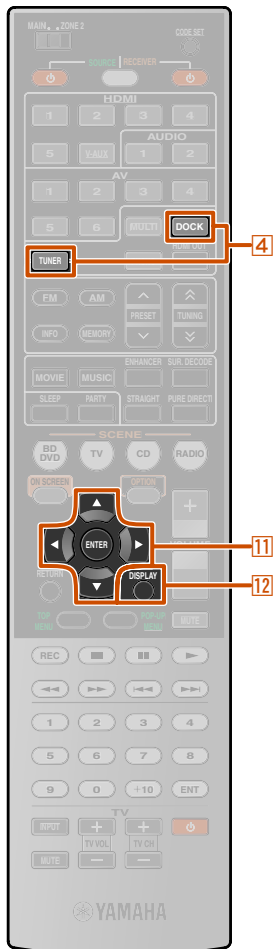
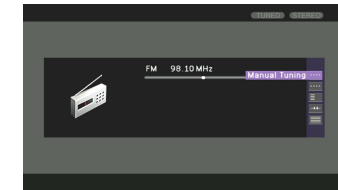

- 4** DOCK
- 4** TUNER
- 11** Cursor $\Delta / \nabla / \triangleleft / \triangleright$
- 11** ENTER
- 12** DISPLAY

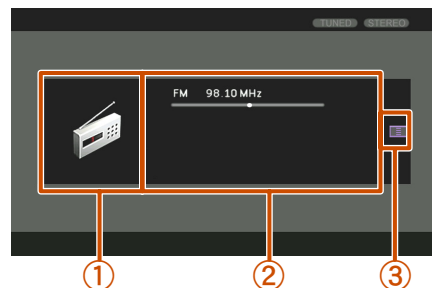

- ① **Image display**
Icon for each input source or album art is displayed.
- ② **Information display**
Information on the current input source is displayed.



FM/AM tuning

When using the FM/AM tuner, adjust the direction of the FM/AM antenna connected to this unit to get the best reception.

(Asia and General models only)

The factory pre-set FM/AM tuner frequency steps are 9 kHz for AM and 50 kHz for FM.

Carry out the following settings and select the frequency steps suitable for your listening environment.

- 1** Switch this unit to the standby mode.
- 2** Press **MAIN ZONE**  while pressing and holding **STRAIGHT** on the front panel.
Release the keys when “ADVANCED SETUP” is displayed on the front panel display.
After approximately a few seconds, the top menu items are displayed.  1

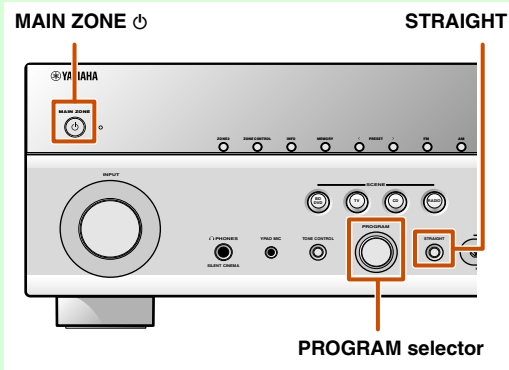

- 3** Rotate **PROGRAM** selector to display “TU.”



- 4** Press **STRAIGHT** repeatedly to select a frequency steps.

- 5** Switch this unit to the standby mode, and then switch it on again.

The power turns on, with the settings you made configured.

Selecting a frequency for reception (Normal tuning)

- 1** Press **4** **TUNER** to switch to the tuner input.
- 2** Press **5** **FM** or **5** **AM** to select a band to receive.



Continues to the next page



- 4** TUNER
- 5** FM
- 5** AM

 1 : Refer to the “Extended functionality that can be configured as needed (Advanced Setup menu)” ([see p. 96](#)) for details on the Advanced Setup menu.



- 5 MEMORY
- 5 PRESET ^ / v
- 5 TUNING ^ / v
- 13 Numeric keys

3 Use 5 TUNING ^ / v to set a frequency to receive.

5 TUNING ^

Increases the frequency. Press and hold this key for longer than a second to search automatically for a station on a higher frequency than the current one. 🌱1

5 TUNING v

Decreases the frequency. Press and hold this key for longer than a second to search automatically for a station on a lower frequency than the current one. 🌱1

Lights up when a broadcast is received from a station

Lights up when a stereo broadcast is received



■ Entering a frequency number

In normal tuning mode, use the 13 Numeric keys to enter a frequency. Leave the decimal point out when entering a number. 🌱2

For example, enter as follows to select a station on 98.50 MHz.

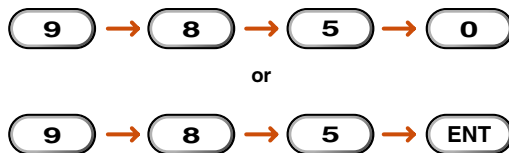

■ Registering stations manually (Manual Preset)

Select stations manually and register them as presets individually.

1 Tune in to the station you want to register, referring to “Selecting a frequency for reception (Normal tuning).”

2 Use one of the following methods to register the station you are currently receiving.

■ Registering to a preset number to which no station is registered

Press 5 MEMORY for 3 seconds or longer.

The station will be registered automatically to the lowest open preset number (or the next number after the one registered most recently).

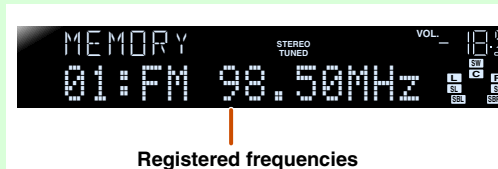

Registered frequencies

■ Designating a preset number for registration

Press 5 MEMORY once, to display “Manual Preset” on the front panel display. After a small wait, the preset number that the station has been registered to will appear.

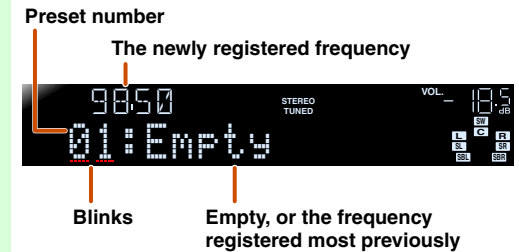

Press 5 PRESET ^ / v to select the preset number to register the station to, and then press 5 MEMORY to register.

To select a registered station, press 5 PRESET ^ / v to select the preset number of the station. 🌱3

🌱1 : When searching for a station, release the key once the search has started.

🌱2 : “Wrong Station!” appears on the front panel display when you enter a frequency that is out of receivable range. Make sure that the frequency entered is correct.

🌱3 : To select a station by selecting a preset number, use the 13 Numeric keys to enter the preset number of the station you want to listen. When an invalid number is entered, “Wrong Num.” appears on the front panel display. Check that you have entered the correct number.

Confirming and operating the FM/AM tuner from the Content window

The station currently received can be confirmed from the menu displayed on the TV screen. Various FM/AM tuner operations can be performed from the Content window rather than controls on the front panel display. The Content window is displayed when **4**TUNER is pressed.

You can operate the FM/AM tuner from the Now Playing view or the Content browse view.

Operating from the Now playing view

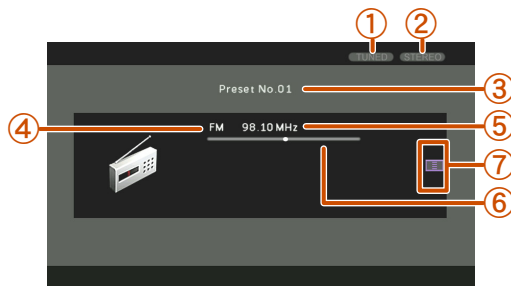

- ① **Tuned indicator**
Lights up when a station is received.
- ② **Stereo indicator**
Lights up when a stereo broadcast is received. When “FM Mode” is set to “Mono,” the indicator does not light.
- ③ **Preset number**
The selected preset number is displayed.
- ④ **Band**
The selected band (FM or AM) is displayed.
- ⑤ **Frequency**
The frequency currently received is displayed.
- ⑥ **Frequency guide**
The frequency currently received is displayed as a cursor on the bar.
- ⑦ **Screen button area**
Buttons for available operations are displayed. See “Screen buttons on the Now playing view” for details.

Screen buttons on the Now playing view

To use these buttons, first press **11**ENTER. Then select the desired one with **11**Cursor Δ / ∇ and **11**ENTER.

Manual Tuning

You can tune in to a desired FM/AM station by specifying its frequency.

FM	Switches a band to FM.
AM	Switches a band to AM.
Tuning -	Decreases the frequency.
Tuning +	Increases the frequency.
Auto -	Automatically searches for a station on a lower frequency than the current station.
Auto +	Automatically searches for a station on a higher frequency than the current station.
Direct	Selects the frequency manually.
Memory	Registers the station currently received as a preset station. Up to 40 FM/AM stations can be registered.

Preset Select

You can call preset stations.

PRESET -	Selects the previous preset number.
PRESET +	Selects the next preset number.
Preset -8	Returns the previous page.
Preset +8	Goes to the next page.
Direct	Selects a station directly by entering the preset number.
Memory	Registers the station currently received as a preset station. Up to 40 FM/AM stations can be registered.

Utility

FM Mode

Selects “Stereo” or “Mono” when receiving the FM station.

Scroll

Switches the scroll target.

Browse

Switches the display to the Content browse view.

Continues to the next page

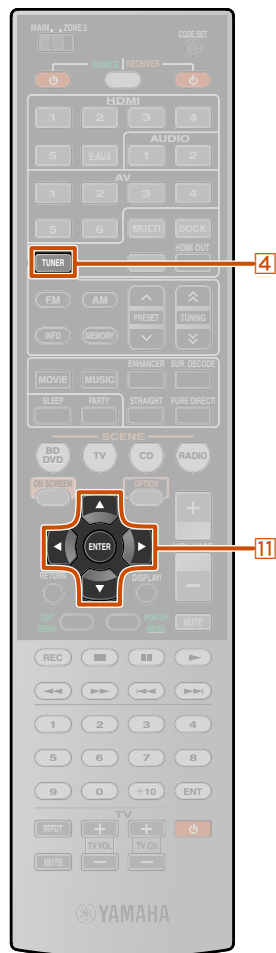

4 TUNER

11 Cursor Δ / ∇

11 ENTER

Operating from the Content browse view

Now Playing

Switches the display to the Now playing view.

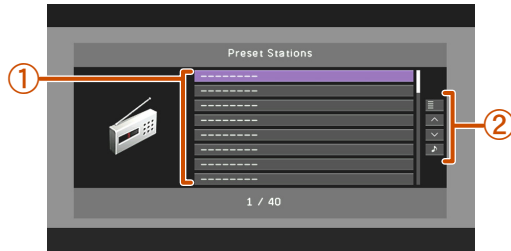

- ① **Preset station list**
The list of preset stations is displayed.
- ② **Screen button area**
Buttons for available operations are displayed. See “Screen buttons on the Content browse view” for details.

Screen buttons on the Content browse view

To use these buttons, first press **Cursor** . Then select the desired one with **Cursor** and **ENTER**.

Utility

Auto Preset	Detects stations with a strong signal and automatically registers up to 40 stations, beginning with the next number after the current number.
Clear Preset	Clears registration of the preset station currently selected.
Clear All Preset	Clears registration of all preset stations.

1 Page Up

1 Page Down

Scrolls the list to the next or previous page.



11 **Cursor**

11 **ENTER**

Playing back tunes from your iPod™/iPhone™

Once you have connected a Universal Dock for iPod/iPhone (such as the YDS-12, sold separately) to this unit, you can enjoy playback of your iPod/iPhone using the remote control supplied with this unit. When playing back from an iPod/iPhone, you can also use the compressed music enhancer sound programs to give compressed audio formats such as MP3 a sharper, more dynamic sound ([esp. 45](#)). A Yamaha iPod wireless system (YID-W10, sold separately) can also be connected to this unit to play back iPod/iPhone with wireless connection.

- **When playing back iPod/iPhone with wired connection**

Refer to “Connecting the Universal Dock for iPod/iPhone.”

- **When playing back iPod/iPhone with wireless connection**

Refer to “Playing iPod™/iPhone™ with wireless connection” ([esp. 62](#)).

CAUTION

To prevent accidents, switch this unit to standby mode before connecting the Universal Dock for iPod/iPhone.

Switch this unit on and place your iPod/iPhone in the dock. The unit is now ready for playback.



Connecting the Universal Dock for iPod/iPhone

Use the dedicated cable to connect the dock to the DOCK jack on the rear panel of this unit. Refer to the operating instructions of the Universal Dock for iPod/iPhone for information on how to connect your iPod/iPhone.

- iPod touch, iPod (4th Gen/5th Gen/Classic), iPod nano, iPod mini, iPhone, iPhone 3G, and iPhone 3GS are supported (As of March 2010).
- When connecting iPhone, iPhone 3G and iPhone 3GS, use a YDS-12.
- Some features may not be compatible depending on the model or the software version of your iPod/iPhone.
- Some functions may not be available for some Universal Dock for iPod/iPhone models. This explanation focuses on the YDS-12.

Universal Dock for iPod/iPhone

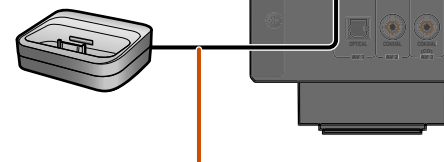

Locate the dock at the distance as far as from the unit.

When this unit is in standby mode, iPod/iPhone can be charged automatically ([esp. 68](#)).

Controlling an iPod™/iPhone™

After setting your iPod/iPhone in your dock, just press **4 DOCK** to switch to DOCK input to play your iPod/iPhone.

The iPod/iPhone can be operated in the following two ways.

Menu browse control:

Plays the iPod/iPhone while viewing the menu displayed on the TV. Refer to “Playing iPod/iPhone from the menu screen (Menu browse control)” ([esp. 60](#)).

Simple remote control:

Plays audio and video through this unit while viewing the menu displayed on the iPod/iPhone screen. Refer to “Operating basic playback functions via the remote control (Simple remote control)” ([esp. 62](#)).

- Song information (artist, album, song) is displayed on the front panel. Press **6 INFO** repeatedly to display subsequent/previous information.
- The Yamaha logo is displayed on the iPod screen when iPod stationed in the Universal Dock for iPod/iPhone (does not apply to the iPod touch or iPhone).
- Manual control of the iPod/iPhone is not possible while the iPod stationed in the Universal Dock for iPod/iPhone.



4 DOCK
6 INFO

Playing iPod/iPhone from the menu screen (Menu browse control)

The iPod/iPhone can be operated from the menu displayed on the TV screen.

You can operate the iPod/iPhone from the Now playing view or the Content browse view.

Operating from the Content browse view

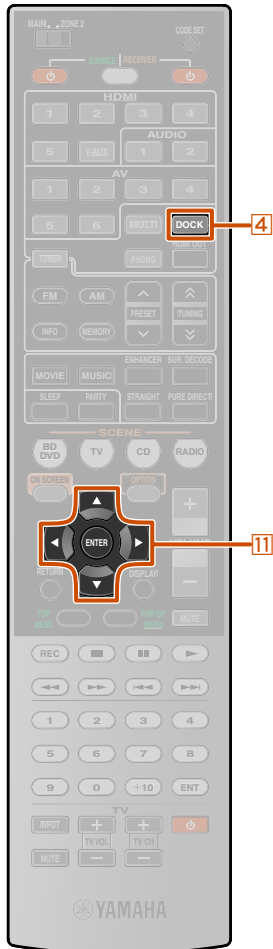

- 4 DOCK
- 11 Cursor Δ / ∇ / \triangleleft / \triangleright
- 11 ENTER

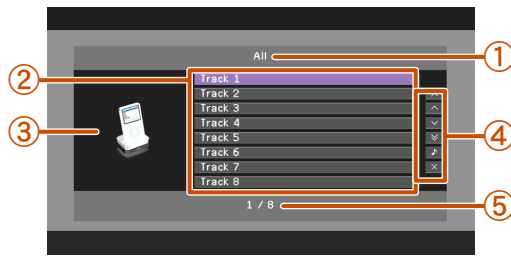

- 1 Input name / List name
- 2 Menu items
- 3 Input icon
- 4 Screen button area
Buttons for available operations are displayed. See "Screen buttons on the Content browse view" for details.
- 5 Current menu number / Number of all menu items

Screen buttons on the Content browse view

To use these buttons, first press 11 Cursor \triangleright . Then select the desired one with 11 Cursor Δ / ∇ and 11 ENTER.

10 Pages Up

10 Pages Down

Goes to 10 pages forwards or backwards.

1 Page Up

1 Page Down

Scrolls the list to the next or previous page.

Now Playing

Switches the display to the Now playing view.

Close

Returns to the video playback, turning off the menu display.

1 Press 4 DOCK to switch to the DOCK input.

2 Press 11 Cursor Δ / ∇ to select the content (music or video) that you want to play, and press 11 ENTER. 1

3 Press 11 Cursor Δ / ∇ to select iPod/iPhone menu items, and press 11 ENTER to play.

The Now playing view appears during playback.

Operating from the Now playing view

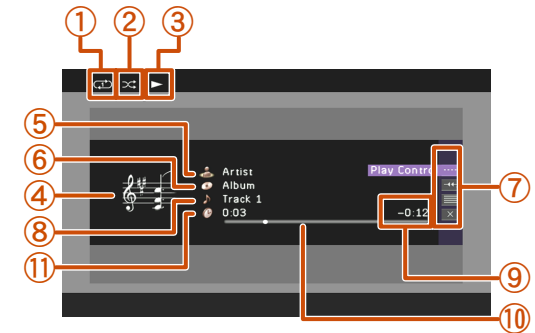

- 1 Repeat icon
- 2 Shuffle icon
- 3 Play icon
- 4 Album image
- 5 Artist name
- 6 Album title
- 7 Screen button area
Buttons for available operations are displayed. See "Screen buttons on the Now playing view" for details.
- 8 Song title
- 9 Remaining time
- 10 Progress bar
- 11 Elapsed time

Screen buttons on the Now playing view

To use these buttons, first press 11 ENTER. Then select the desired one with 11 Cursor Δ / ∇ and 11 ENTER.

1: Videos will not be displayed when your iPod or Universal Dock for iPod/iPhone do not support the browser function for browsing video files.

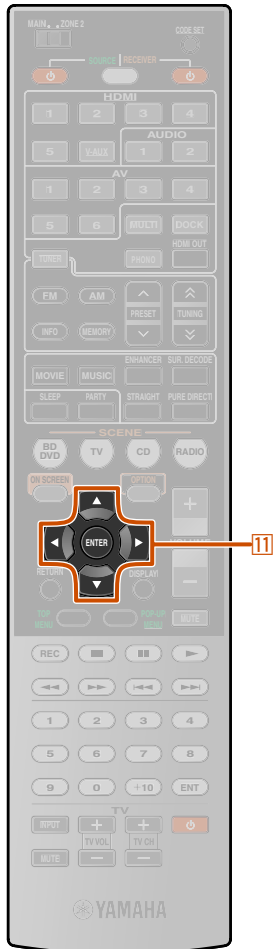

11 ENTER

Play Control

Operates the basic playback functions of iPod/iPhone.

▷ (Play)	Starts playback.
◻ (Stop)	Stops playback.
⏸ (Pause)	Stops playback temporarily.
⏮ (Skip -)	Skips to the beginning of the currently playing song. Press 11 ENTER at the beginning of the song to skip to a previous song.
⏭ (Skip +)	Skips to the beginning of the next song.
⏪ (Scan -)	Searches backwards.
⏩ (Scan +)	Searches forwards.

Scroll

Switches the scroll target (artist name, album name, or song name).

Browse

Switches the display to the Content browse view.

Close

Returns to the video playback, turning off the menu display.

Operating basic playback functions via the remote control (Simple remote control)

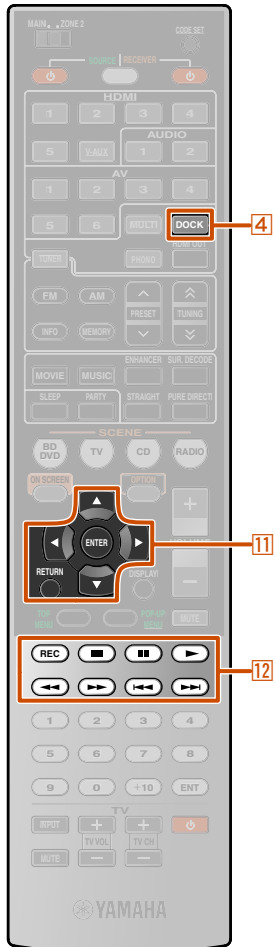

Use the following remote control keys to operate (playback, stop, skip, etc.) your iPod/iPhone. Press **[12] REC** to enable the Simple remote control. Press **[12] REC** again to return to the Menu browse control.

[4] DOCK	Switches to the DOCK (iPod) input.
[11] Cursor Δ / ▽	Move the cursor up and down to different fields.
[11] RETURN	Returns to the previous menu.
[11] ENTER	Enables the selected menu.
[12] ⏮	Searches backwards while held down.
[12] ⏭	Searches forwards while held down.
[12] ⏮	Skips to the beginning of the currently playing song. Pressing repeatedly skips one song backwards with each press.
[12] ⏭	Skips to the beginning of the next song.
[12] □	Stops playback.
[12] ⏸	Switches between playback and pause.
[12] ▶	Switches between playback and pause.

Playing iPod™/iPhone™ with wireless connection

A Yamaha iPod wireless system (YID-W10, sold separately) can be connected to this unit to play back iPod/iPhone with wireless connection. The iPod/iPhone can be used as the remote control. 1

Connecting the Yamaha iPod wireless transmitter and playing back iPod/iPhone

Use the dedicated cable to connect the wireless receiver to the DOCK jack on the rear panel of this unit. Refer to the operating instructions of the YID-W10 for more information.

CAUTION

To prevent accidents, unplug the power cable of this unit before connecting the iPod wireless receiver.

Place the iPod/iPhone in the wireless transmitter. Setup is complete.

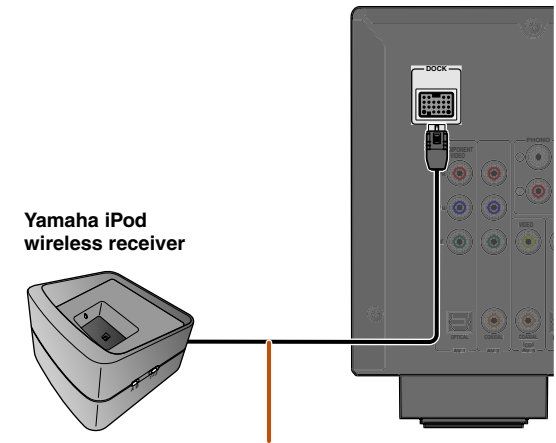

Position the wireless receiver as far as possible from the unit.

When this unit is in standby mode, iPod/iPhone can be charged automatically, if “Standby Charge” is set to “Auto” ([p. 68](#)) or “Power & Input” of “iPod Interlock” is set to “On” ([p. 69](#)).

- [4] DOCK**
- [11] Cursor Δ / ▽**
- [11] ENTER**
- [11] RETURN**
- [12] REC**
- [12] □**
- [12] ⏸**
- [12] ▶**
- [12] ⏮**
- [12] ⏭**
- [12] ⏮**
- [12] ⏭**

1 : Video signals cannot be transmitted wirelessly.



4 DOCK

Use iPod/iPhone to start playback.

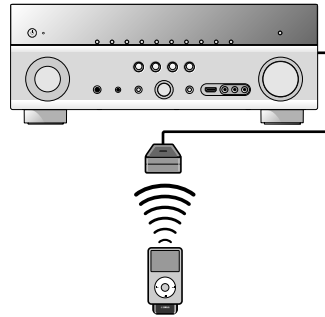

- This unit, which is placed in the main zone, functions as follows when iPod/iPhone controls are used to start playback.
 - The input source switches to DOCK (iPod) when this unit is turned on.
 - When this unit is in standby mode when iPod/iPhone playback starts, this unit turns on and the input source switches to DOCK (iPod). 1
- This unit automatically enters standby mode when the following operations are performed.
 - iPod/iPhone is removed from the YID-W10
 - iPod/iPhone is not operated for a while after playback is stopped

- Pressing  DOCK also switches the input source to DOCK (iPod).
- When a menu is operated, this function is not activated.
- When “iPod Interlock” → “Power & Input” in the Input menu is set to “Off,” the power and the input source do not switch automatically ([p. 69](#)).

- Adjusting volume control on the iPod/iPhone also adjusts the volume (max 0.0 dB) of this unit.

When “iPod Interlock” → “Volume” in the Input menu is set to “Off,” the volume of this unit is not adjusted when iPod/iPhone volume controls are adjusted ([p. 69](#)).

CAUTION

When iPod/iPhone controls are used to adjust volume, playback volume may be unexpectedly loud. This could result in damage to this unit or the speakers. If the volume suddenly increases during playback, immediately remove the iPod/iPhone from the Universal Dock for iPod/iPhone. “Max Volume” can be used to specify the maximum volume level to prevent excessively loud playback ([p. 83](#)).

1 : This function is also activated when sound of application is reproduced or ringtone is received.

Playing back tunes from Bluetooth™ components

You can connect a Yamaha Bluetooth wireless audio receiver (such as the YBA-10, sold separately) to this unit and enjoy wireless playback from Bluetooth-compatible portable music players. 📶1

NOTE

When playing back from a Bluetooth component for the first time, you must first pair the devices (register the Bluetooth components). When establishing a wireless connection you must carry out pairing on both this unit and on the Bluetooth component.

Connecting a Yamaha Bluetooth wireless audio receiver

Use the dedicated cable to connect the dock to the DOCK jack on the rear panel of this unit. The Bluetooth wireless audio receiver connection will be complete when this unit is turned on.

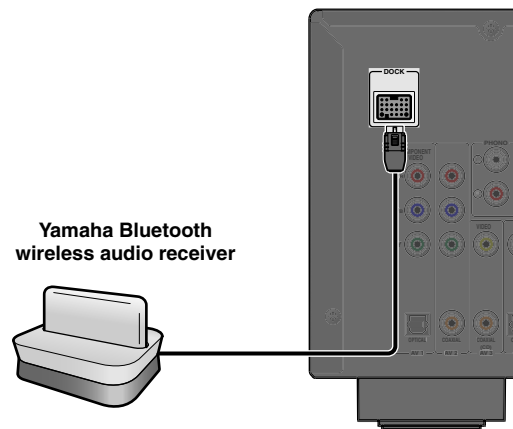

Yamaha Bluetooth wireless audio receiver

CAUTION

To prevent accidents, switch this unit to standby mode before connecting a Bluetooth wireless audio receiver.

Pairing Bluetooth™ components

Be sure to carry out pairing when connecting a Bluetooth component for the first time, or when settings have been deleted. Refer to the operating instructions of your Bluetooth component as necessary when carrying out pairing.

The Yamaha Bluetooth wireless audio receiver can be paired with up to eight Bluetooth components. When the ninth device is paired, the pairing settings for the device which has not been used for the longest period of time will be deleted.

- 1 Press **4 DOCK** to switch to the DOCK input.
- 2 Turn on the Bluetooth component you want to pair with and set it to pairing mode.

- 3 Press **20 OPTION** to display the OPTION menu and use **11 Cursor Δ / ▽** to select "Pairing."



- 4 Press **11 ENTER** to start pairing.



- To cancel pairing, press **11 RETURN**.
- You can also press and hold **5 MEMORY** on the front panel to begin pairing.

Continues to the next page

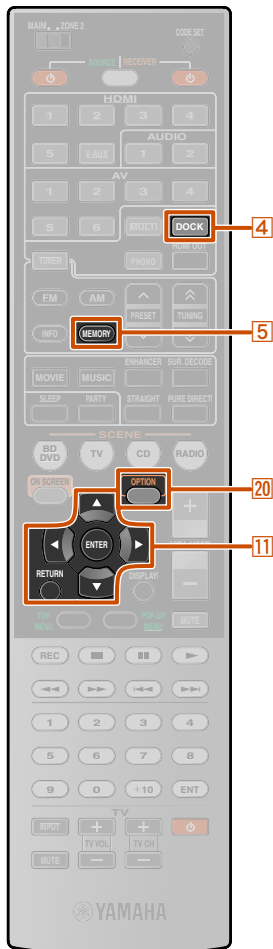

- 4 DOCK**
- 5 MEMORY**
- 11 Cursor Δ / ▽**
- 11 ENTER**
- 11 RETURN**
- 20 OPTION**

📶1 : This unit supports A2DP (Advanced Audio Distribution Profile) of the Bluetooth profile.

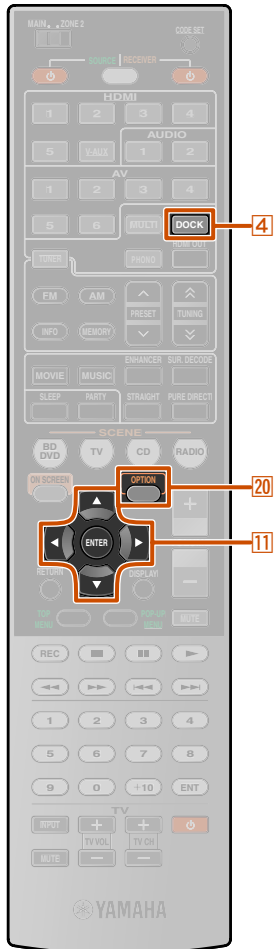

- 4** DOCK
- 11** Cursor Δ / ∇
- 11** ENTER
- 20** OPTION

5 Make sure the Bluetooth component recognizes the Bluetooth wireless audio receiver.

When the device is recognized, it will appear in the Bluetooth component list, for example as “YBA-10 YAMAHA.”

6 Select the Bluetooth wireless audio receiver from the Bluetooth component list, and enter a pass key “0000” into the Bluetooth component.

When pairing occurs correctly



Using Bluetooth™ components

When pairing is complete, perform the following procedure to achieve a wireless connection between this unit and the Bluetooth component. When the wireless connection is complete, Bluetooth components can be played back.

Depending on Bluetooth components, a wireless connection is established automatically or by operating the Bluetooth components. In that case, it is not necessary to carry out the following procedure.

1 Press **4** DOCK to switch to the DOCK input.

2 Press **20** OPTION to display the OPTION menu.

3 Use **11** Cursor Δ / ∇ to select “Connect” and press **11** ENTER.

When wireless connection is complete



“Not found” is displayed when there is an error connecting. Check that the following conditions have been satisfied, and try to establish a wireless connection again.

- Both this unit and the Bluetooth component are paired.
- The Bluetooth component is switched on.
- The Bluetooth component is within 10 m of the Bluetooth wireless audio receiver.

4 Operate the Bluetooth component for playback.

To disconnect a wireless connection, repeat the same steps, and in step 3, select “Disconnect.”

1 : Depending on Bluetooth components, wireless connection is carried out right after the pairing. In this case, “BT connected” is displayed instead of “Completed.”

2 : “Disconnect” is displayed when a Bluetooth component has been connected.

SETUP

Configuring input sources (Input menu)

Settings, such as the name of an input source or the icon displayed for an input source can be changed from the Input menu.

Configuring input sources

The name of an input source and its icon, as well as other input source settings, can be changed from the Input menu displayed on the TV screen.

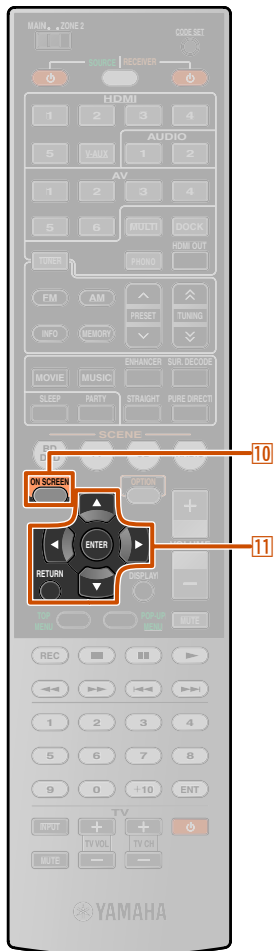

- 10 ON SCREEN
- 11 Cursor $\Delta / \nabla / \leftarrow / \rightarrow$
- 11 ENTER
- 11 RETURN

- 1 Press **10 ON SCREEN**.

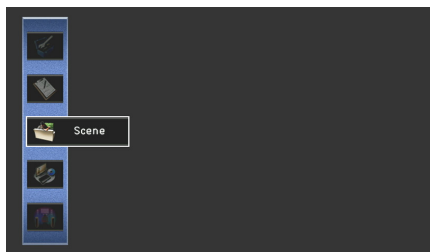

- 2 Use **11 Cursor Δ / ∇** to select "Input" and press **11 ENTER**.

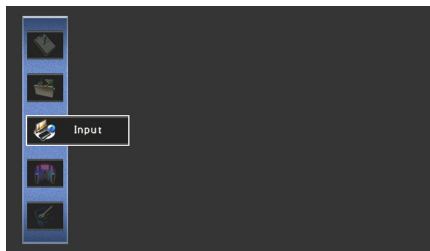

- 3 Use **11 Cursor \leftarrow / \rightarrow** to select an input source to be configured and press **11 Cursor Δ** .

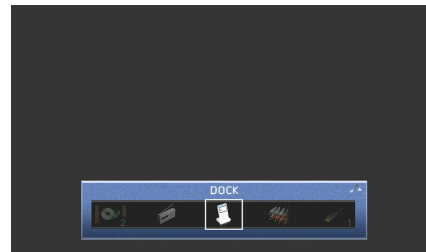

- 4 Use **11 Cursor Δ / ∇** to select an item and press **11 ENTER**.

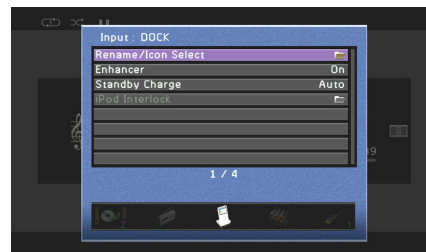

If the selected item contains additional items, use **11 Cursor Δ / ∇** to select the desired item and press **11 ENTER**.

- 5 Use **11 Cursor Δ / ∇** to adjust the setting.

Pressing **11 RETURN** displays the previous menu screen. Repeat steps 4 to 5 to adjust multiple settings.

- 6 Press **10 ON SCREEN** to close the menu.





1 Cursor $\Delta / \nabla / \triangleleft / \triangleright$
1 ENTER

Input menu

HDMI1-5	Rename/ Icon Select	Audio In	Decoder Mode
	Enhancer		
AV1-2	Rename/ Icon Select	Audio In	Decoder Mode
	Enhancer		
AV3-4	Rename/ Icon Select	Decoder Mode	Enhancer
AV5-6	Rename/ Icon Select	Enhancer	
AUDIO1-2	Rename/ Icon Select	Enhancer	
V-AUX	Rename/ Icon Select	Decoder Mode	Enhancer
PHONO	Rename/ Icon Select	Enhancer	
TUNER	Enhancer		
DOCK (iPod)	Rename/ Icon Select	Enhancer	Standby Charge
	iPod Interlock 		
DOCK (Bluetooth)	Rename/ Icon Select	Enhancer	
MULTI CH	Rename/ Icon Select	Video Out	

Changing an input source name or icon

Rename/Icon Select

Input source: HDMI1-5, AV1-6, AUDIO1-2, V-AUX, DOCK (iPod), DOCK (Bluetooth), MULTI CH

Changes the input source name (up to nine characters) and icon displayed on the front panel display or TV screen.

1 Use **1**Cursor Δ / ∇ repeatedly to select “Rename/Icon Select” and press **1**ENTER.

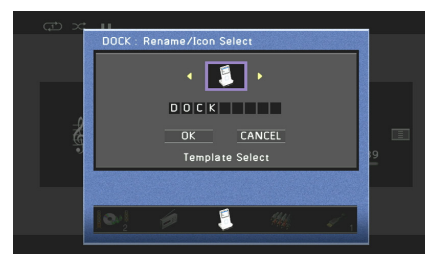

2 Use **1**Cursor $\triangleleft / \triangleright$ to choose an icon and press **1**Cursor ∇ .

3 Press **1**ENTER, and then press **1**Cursor $\Delta / \nabla / \triangleleft / \triangleright$ to edit the new input name.

4 Press **1**ENTER and press **1**Cursor ∇ to select “OK” and press **1**ENTER.
 Confirm the new input name.

 **1**: Not available when playing back iPod/iPhone with wired connection.

Combining HDMI/AV1-2 input source video and audio

Audio In

Input source: HDMI1-5, AV1-2

Combines video from HDMI or AV input sources with analog/digital audio inputs in situations such as:

- an playback device is connected with an HDMI cable but cannot transmit audio through HDMI
- an playback device with component video output and analog audio output (such as certain game consoles) are connected to the system

To change assignments, select an input source (HDMI1-5 or AV1-2) as the video input first, and then select audio input jacks in this menu.

Set as follows according on the desired combination of audio input jacks.

Audio inputs	Settings method
Optical digital audio input	Select AV1 or AV4. Connect the external component audio cable to the optical digital jack for the selected input.
Coaxial digital audio input	Select AV2 or AV3. Connect the external component audio cable to the coaxial digital jack for the selected input.
Analog audio input	Select one of AV5, AV6, AUDIO1, or AUDIO2. Connect the external component audio cable to the audio jack for the selected input.

Setting the format of digital audio signals

Decoder Mode

Input source: HDMI1-5, AV1-4, V-AUX 1

Sets the format of digital audio to playback to DTS. For example, if the format is not automatically detected correctly even during playback of DTS format audio, this item can be used to set the playback format to DTS.

Auto (Default)	The audio format is automatically selected to match the format of the input audio.
DTS	Selects DTS signals only. Other input signals are not reproduced.

Selecting the sound program suitable for listening to compressed audio, such as MP3

Enhancer

Input source: All input sources other than MULTI CH

Turns on/off the Compressed Music Enhancer mode.

Off (Default)	Turns off the Compressed Music Enhancer mode.
On	Turns on the Compressed Music Enhancer mode.

Charging an iPod™/iPhone™ in standby mode

Standby Charge

Input source: DOCK (iPod)

Charges an iPod/iPhone stationed in the Universal Dock for iPod / iPhone or iPod wireless receiver while the receiver is in standby mode.

Auto (Default)	This unit charges iPod/iPhone when this unit is in standby mode. While charging an iPod/iPhone, the HDMI Through/iPod Charge indicator lights. When HDMI Through function is off, the indicator goes out after the charging is complete.
Off	This unit does not charge iPod/iPhone.

 1: AV5-6 or AUDIO1-2 are also available when "Audio Return Channel" is on, and the input source is used for "TV Audio Input."

■ Setting the interlock functions with iPod/iPhone (when a Yamaha iPod wireless receiver is connected)

iPod Interlock

Input source: DOCK (iPod)

This unit can be automatically operated in conjunction with operations on iPod when the iPod wireless receiver is connected to this unit.

Power & Input	Starting playback of iPod/iPhone turns on this unit and switches the input source to DOCK (iPod) automatically when this item is set to "On." This unit automatically enters standby mode when iPod/iPhone is not operated for a while after playback is stopped. This interlock function is disable with "Off."
Volume	Adjusting the volume on the iPod/iPhone also adjusts the volume of this unit when this item is set to "On." This interlock function is disable with "Off."

■ Outputting a video signal input from another input source while playing a multi-channel audio signal

Video Out

Input source: MULTI CH

When "MULTI CH" is selected as the input source, a video signal input from another terminal can be output to the video monitor. For example, even if an audio and video component such as a DVD player that does not support a multi-channel digital audio output, the video signal can be output to the video monitor while reproducing a multi-channel analog audio signal.

Editing the SCENE function (SCENE menu)

The SCENE function ([p. 42](#)) can be edited from the SCENE menu displayed on the TV screen.

Editing a scene

Various settings, such as the name of a scene or the icon displayed for a scene, can be changed from the SCENE menu.

- 1 Press **[ON SCREEN]**.

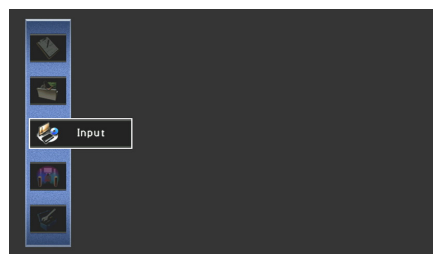

- 2 Use **[Cursor Δ / ▽]** to select "Scene" and press **[ENTER]**.

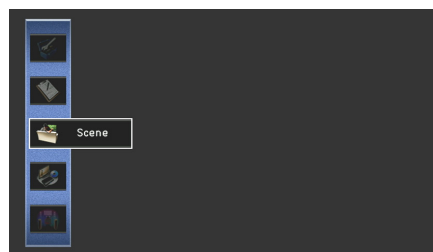

- 3 Use **[Cursor < / >]** to select a scene to be edited and press **[Cursor Δ]**.

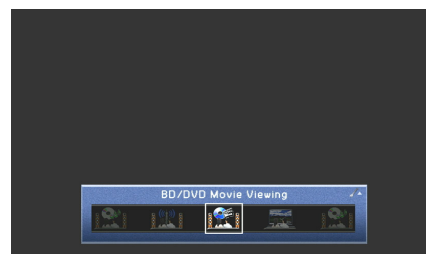

- 4 Use **[Cursor Δ / ▽]** to select an item and press **[ENTER]**.



When the Utility is available in the selected item, use **[Cursor Δ / ▽]** to select the Utility and press **[ENTER]**.

- 5 Use **[Cursor Δ / ▽ / < / >]** to adjust the setting.

Pressing **[RETURN]** displays the previous menu screen. Repeat steps 4 and 5 to adjust multiple settings.

- 6 Press **[ON SCREEN]** to close the menu.

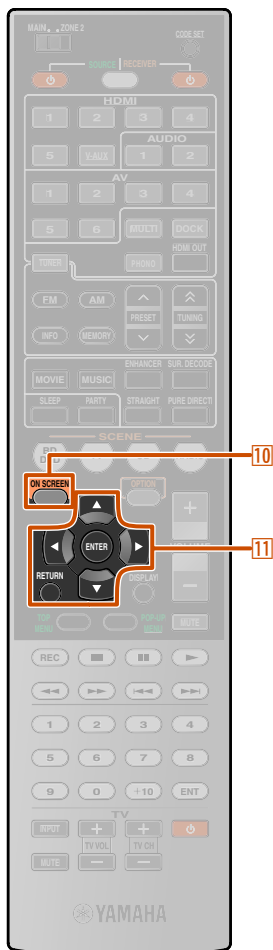

- [ON SCREEN]**
- [Cursor Δ / ▽ / < / >]**
- [ENTER]**
- [RETURN]**

SCENE menu

- SCENE1**
 - Save
 - Load
 - Rename/Icon Select
 - Reset
- SCENE2**
 - Save
 - Load
 - Rename/Icon Select
 - Reset
- SCENE3**
 - Save
 - Load
 - Rename/Icon Select
 - Reset
- SCENE4**
 - Save
 - Load
 - Rename/Icon Select
 - Reset

Registering SCENE function settings

Save

Registers the setting currently applied to this unit for each SCENE.

Adjusting settings registered with the SCENE function

Load

Loads input sources or sound programs that have been registered with the SCENE function, or specifies whether or not an external component registered as the input source is automatically turned on when a scene is selected.

Ok	Loads items indicated with a check mark in "Setting."
Cancel	Cancels settings applied with "Setting."
DETAIL	Specifies "SCENE IR" function and displays settings registered with the SCENE function in detail. For more information, see "SCENE IR" and "Detail" at right.

SCENE IR

Specify whether or not a Yamaha BD/DVD player or CD player connected to this unit turns on automatically.

Off	Disables the SCENE IR function.
Yamaha BD/DVD Player1	Select this when a Yamaha BD/DVD player is connected to this unit.
Yamaha BD/DVD Player2	Select this if the player dose not turn on when "Yamaha BD/DVD Player1" is selected.
Yamaha CD Player	Select this when a Yamaha CD player is connected to this unit.

Detail

Display details of settings registered with the SCENE function. Items indicated with a check mark in "Setting" are loaded.

Input	Displays the "Input" setting registered with the SCENE function.
Mode	Displays the sound program registered with the SCENE function.
Enhancer	Displays the "Enhancer" setting registered with the SCENE function.

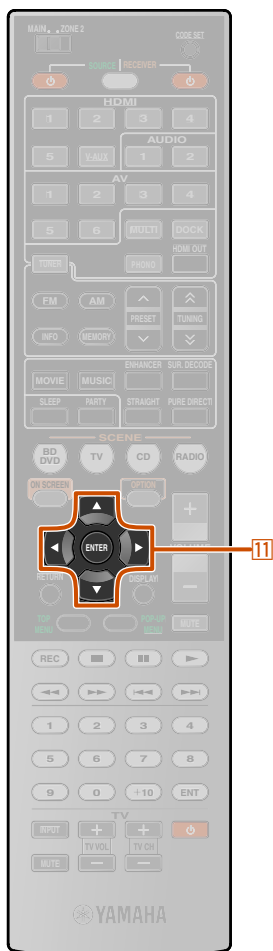

11 Cursor $\Delta / \nabla / \leftarrow / \rightarrow$
 11 ENTER

Changing a scene name and icon

Rename/Icon Select

Changes the scene name and icon displayed on the front panel display or TV screen.

- 1 Use **11**Cursor Δ / ∇ repeatedly to select “Rename/Icon Select” and press **11**ENTER.

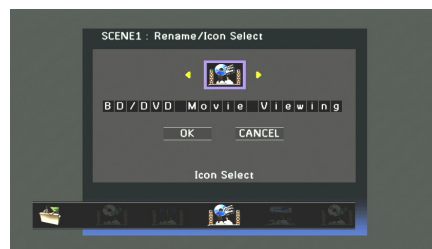

- 2 Use **11**Cursor \leftarrow / \rightarrow to choose an icon and press **11**Cursor ∇ .

- 3 Press **11**ENTER, and then press **11**Cursor $\Delta / \nabla / \leftarrow / \rightarrow$ to edit the new scene name.

- 4 Press **11**ENTER and press **11**Cursor ∇ to select “OK” and press **11**ENTER.

Confirm the new scene name.

Resetting a scene

Reset

Restores all settings to their default values.

Setting sound program parameters (Sound Program menu)

Sound effects can be adjusted from the Sound Program menu.

Editing sound programs

Adjust sound field elements (sound program parameters) to achieve sound effects suited to the acoustics of audio/video sources or rooms if you are not satisfied with the results achieved with default sound program settings. Follow the procedure described below to adjust sound program parameters.

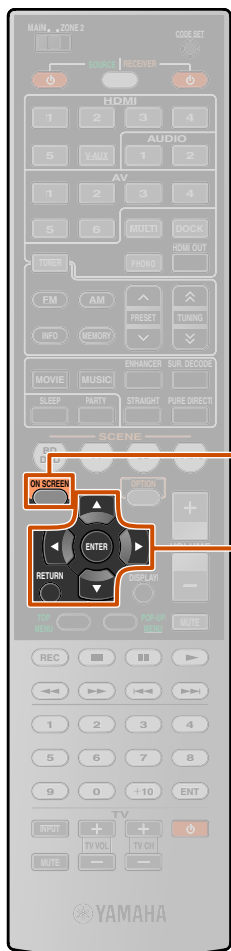

1 Press **10** ON SCREEN.

2 Press **11** Cursor Δ / ∇ repeatedly to select “Sound Program” and press **11** ENTER.

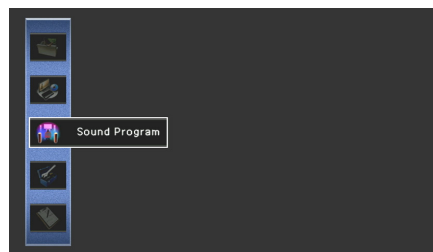

3 Use **11** Cursor \leftarrow / \rightarrow to select a sound program and press **11** Cursor Δ .

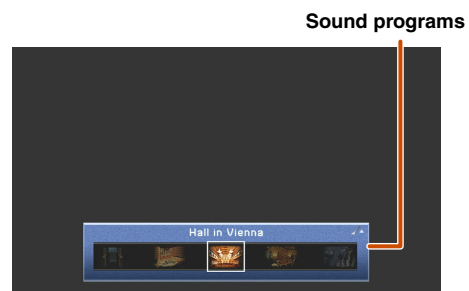

4 Use **11** Cursor Δ / ∇ to select a parameter and press **11** ENTER.

Sound program parameters



Choices

5 Use **11** Cursor \leftarrow / \rightarrow to adjust the parameter and press **11** RETURN. 1

When there are multiple parameters in the selected sound program, repeat steps 4 and 5 to adjust other parameters.

6 Press **10** ON SCREEN to close the Sound Program menu.

■ To initialize sound program parameters

To set the parameters of the sound program back to their default settings, use **11** Cursor Δ / ∇ repeatedly to select “Reset” in step 4 and press **11** ENTER. When the following message is displayed, select “OK” and press **11** ENTER to initialize.

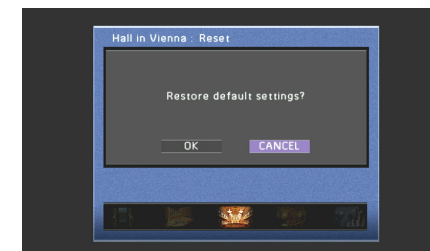

To cancel initializing, select “CANCEL” and press **11** ENTER when the message above is displayed.

- 10** ON SCREEN
- 11** Cursor $\Delta / \nabla / \leftarrow / \rightarrow$
- 11** ENTER
- 11** RETURN

1: An asterisk (*) appears on the left of the sound field parameter name displayed on the TV when you change the parameter from its default setting.

CINEMA DSP parameters

DSP Level

Change the effect level (level of the sound field effect to be added). You can adjust the level of the sound field effect while checking the sound effect.

Adjustable range	-6 dB to +3 dB
Default setting	0 dB

Adjust "DSP Level" as follows:

- The effect sound is too soft.
→ Increase the effect level.
- There are no differences between effects of the sound programs.
→ Increase the effect level.
- The sound is dull.
→ Reduce the effect level.
- The sound field effect is added too much.
→ Reduce the effect level.

Initial Delay

Surround Initial Delay

Surround Back Initial Delay

Initial delay. Presence, surround, and surround back sound field initial delay. Changes the apparent size of the sound field by adjusting the delay between the direct sound and the first reflection heard by the listener. The smaller the value, the smaller the sound field seems to the listener.

Adjustable range	1 to 99 ms (Initial Delay) 1 to 49 ms (Surround Initial Delay and Surround Back Initial Delay)
------------------	---

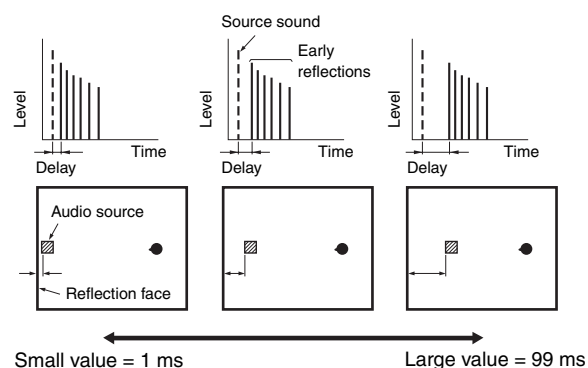

When you adjust the initial delay parameters, we also recommend that you adjust the corresponding room size parameters likewise.

Room Size

Surround Room Size

Surround Back Room Size

Room size. Presence, surround, and surround back room size. Adjusts the apparent size of the sound field. The larger the value, the larger the surround sound field becomes. As the sound is repeatedly reflected around a room, the larger the hall is, the longer the time between the original reflected sound and the subsequent reflections. By controlling the time between the reflected sounds, you can change the apparent size of the virtual venue. Changing this parameter from one to two doubles the apparent length of the room.

Adjustable range	0.1 to 2.0
------------------	------------

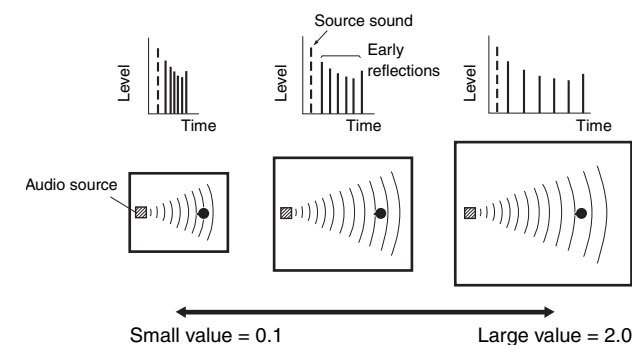

When you adjust the room size parameters, we also recommend that you adjust the corresponding initial delay parameters likewise.

Liveness

Surround Liveness

Surround Back Liveness

Liveness. Surround and surround back liveness. Adjusts the reflectivity of the virtual walls in the hall by changing the rate at which the early reflections decay. The early reflections of an audio source decay much faster in a room with acoustically absorbent wall surfaces than in one which has highly reflective surfaces. A room with acoustically absorbent surfaces is referred to as “dead,” while a room with highly reflective surfaces is referred to as “live.” This parameter lets you adjust the early reflection decay rate and thus the “liveness” of the room.

Adjustable range	0 to 10
-------------------------	---------

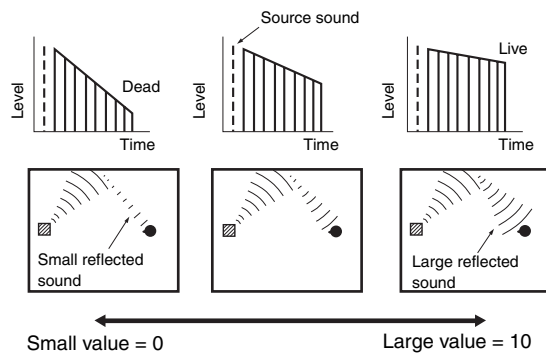

Reverb Time

Reverberation time. Adjusts the amount of time taken for the dense, subsequent reverberation sound to decay by 60 dB at 1 kHz. This changes the apparent size of the acoustic environment over an extremely wide range. Set a longer reverberation time to get more sustaining reverberation sound, and set a shorter time to get articulate sound.

Adjustable range	1.0 to 5.0 s
-------------------------	--------------

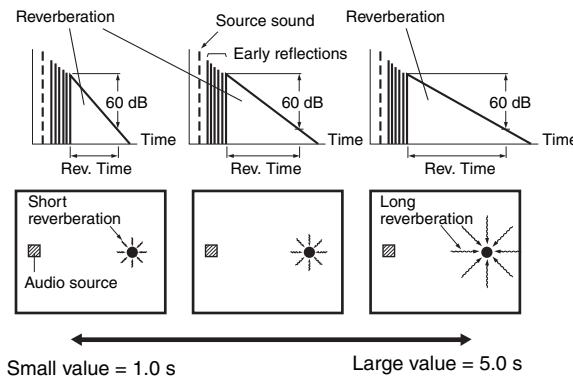

Reverb Delay

Reverberation delay. Adjusts the time difference between the beginning of the direct sound and the beginning of the reverberation sound. The larger the value, the later the reverberation sound begins. A later reverberation sound makes you feel as if you are in a larger acoustic environment.

Adjustable range	0 to 250 ms
-------------------------	-------------

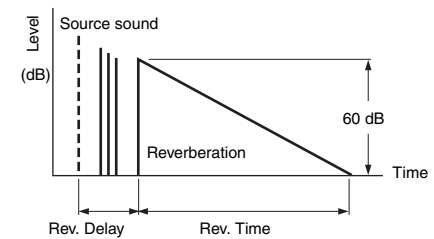

Reverb Level

Reverberation level. Adjusts the volume of the reverberation sound. The larger the value, the stronger the reverberation becomes.

Adjustable range	0 to 100%
-------------------------	-----------

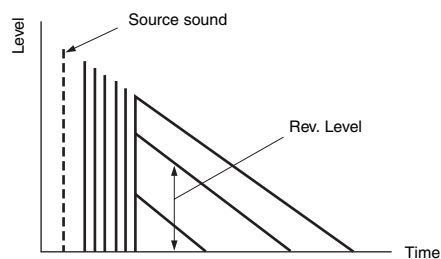

Decode Type

Selects a surround decoder to be used with a sound program in the MOVIE category. 🌟1

PLIIx Movie PLII Movie	Selects the Dolby Pro Logic IIx Movie (or Dolby Pro Logic II Movie) decoder.
Neo:6 Cinema	Selects the Neo:6 (Cinema) decoder.

Parameters usable in certain sound programs

2ch Stereo only

Direct

Automatically bypasses the DSP circuit and tone control circuit depending on the condition of tone control etc., when an analog audio source is played back. You can enjoy a higher quality sound.

Auto (Default)	Outputs sound by bypassing the DSP circuit and tone control circuit when both tone controls of “Bass” and “Treble” are set to 0 dB.
Off	Does not bypass the DSP circuit and tone control circuit.

7ch Stereo only

Center Level

Adjusts the center channel volume. 🌟2

Adjustable range	0 to 100%
Default setting	100%

Surround L Level

Adjusts the volume of the surround L channel. 🌟2

Adjustable range	0 to 100%
Default setting	100%

Surround R Level

Adjusts the volume of the surround R channel. 🌟2

Adjustable range	0 to 100%
Default setting	100%

Surround Back L Level

Adjusts the volume of the surround back L channel. 🌟2

Adjustable range	0 to 100%
Default setting	35% (7.1-channel configuration) 50% (6.1-channel configuration)

Surround Back R Level

Adjusts the volume of the surround back R channel. 🌟2

Adjustable range	0 to 100%
Default setting	35% (7.1-channel configuration) 50% (6.1-channel configuration)

Front Presence L Level

Adjusts the volume of the front presence L channel. 🌟2

Adjustable range	0 to 100%
Default setting	33%

🌟1: Surround decoders cannot be changed when used with the following MOVIE sound programs.

- Mono Movie
- Sports
- Action Game
- Roleplaying Game

🌟2: Not displayed when speakers are set to be inactive.

Front Presence R Level



Adjusts the volume of the front presence R channel. 

Adjustable range	0 to 100%
Default setting	33%

Parameters usable in surround decoder

Decode Type

Selects a surround decoder.

Pro Logic	Reproduces sound using the Dolby Pro Logic decoder. This is suitable for all kinds of audio sources.
PLIIx Movie / PLII Movie	Reproduces sound using the Dolby Pro Logic IIx (or Dolby Pro Logic II) decoder. This is suitable for movies. 
PLIIx Music / PLII Music	Reproduces sound using the Dolby Pro Logic IIx (or Dolby Pro Logic II) decoder. This is suitable for music. 
PLIIx Game / PLII Game	Reproduces sound using the Dolby Pro Logic IIx (or Dolby Pro Logic II) decoder. This is suitable for games. 
Neo:6 Cinema	Reproduces sound using the DTS Neo:6 decoder. This is suitable for movies.
Neo:6 Music	Reproduces sound using the DTS Neo:6 decoder. This is suitable for music.

Dolby PLIIx Music and Dolby PLII Music only

Panorama

Adjusts the soundscape of the front sound field. Sends front left/right channels sounds to the surround speakers as well as the front speakers for a wraparound effect.

Off (Default)	Disables the effect.
On	Enables the effect.

Center Width

Spreads the center channel sound to the front left and right speakers to suit your needs or preferences. Set this parameter to 0 for outputting the center sound from the center speaker only, or to 7 for outputting it from the front left/right speaker only.

Adjustable range	0 to 7
Default setting	3

Dimension

Adjusts the difference in level between the front sound field and the surround sound field. You can adjust the difference in level created by the software being played back to obtain the preferred sound balance. The surround sound gets stronger as you make the value more negative, and the front sound gets stronger as you make the value more positive.

Adjustable range	-3 to +3
Default setting	0

When Neo:6 Music is selected

Center Image

Adjusts the front left and right channel output relative to the center channel to make the center channel more or less dominant as necessary.

Adjustable range	0.0 to 1.0
Default setting	0.3

 1: Not displayed when speakers are set to be inactive.

 2: You cannot select the Dolby Pro Logic IIx decoder in the following conditions:

- When "Surround Back" is set to "None" ([**p. 80](#)).
- When headphones are connected.

Setting various functions (Setup menu)

Various settings, such as speaker volume or HDMI functions, can be changed from the Setup menu.

Operating the Setup menu

- 1 Press **ON SCREEN**.
- 2 Press **Cursor** Δ / ∇ repeatedly to select "Setup" and press **ENTER**.
- 3 Use **Cursor** \leftarrow / \rightarrow to select a menu and press **ENTER**.

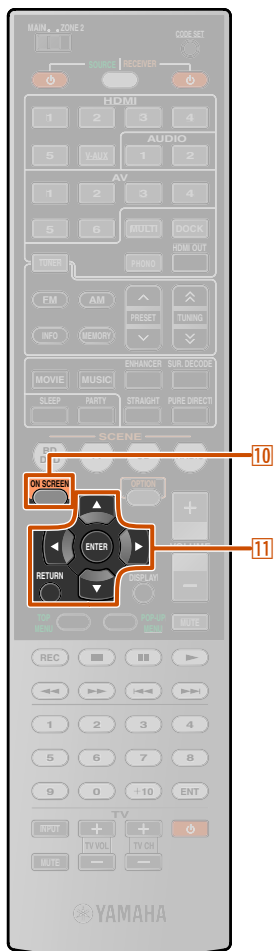

- 10 ON SCREEN
- 11 Cursor $\Delta / \nabla / \leftarrow / \rightarrow$
- 11 ENTER
- 11 RETURN

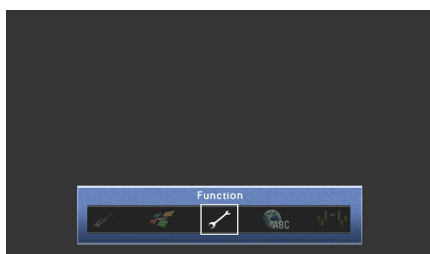
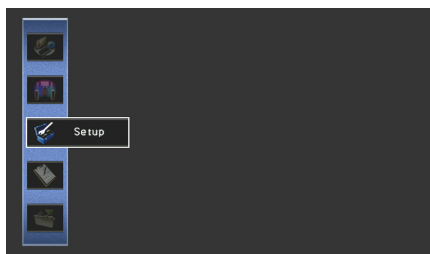

Setup menu setting

Speaker	Adjusts parameters for speakers, such as speaker status, and volume adjustment for each speaker (p. 79).
Sound	Sets functions related to audio output, such as adjustment of maximum volume and of dynamic range (p. 83).
Video	Sets video output functions, such as video conversion settings (resolution and aspect ratio) (p. 84).
HDMI	Sets HDMI functions, such as the HDMI Control function and output destination for HDMI sound (p. 85).
Multi Zone	Sets multi-zone functions, such as volume adjustment for speakers in the secondary zone (p. 88).
Function	Sets functions such as the Auto Power Down function, that make the unit easier to use (p. 88).
Language	Selects the language of the menus and messages displayed on TV screen (p. 91).

- 4 Use **Cursor** Δ / ∇ to select an item and press **ENTER**.



When the selected item contains detailed ones, use **Cursor** Δ / ∇ to select the detailed item and press **ENTER**.

- 5 Use **Cursor** $\Delta / \nabla / \leftarrow / \rightarrow$ to adjust the setting.

Pressing **RETURN** displays the previous menu screen. Repeat steps 4 to 5 to adjust multiple settings.

- 6 Press **ON SCREEN** to close the menu.

Setup menu

- Speaker**
 - Auto Setup
 - Manual Setup
- Sound**
 - Lipsync
 - Dynamic Range
 - Max Volume
 - Initial Volume
 - Adaptive DSP Level
- Video**
 - Analog to Analog Conversion Processing
- HDMI**
 - HDMI Control
 - Control Select
 - ARC (Audio Return Channel)
 - TV Audio Input
 - Audio Output
 - Standby Through
- Multi Zone**
 - Zone2 Set
 - Party Mode Set
- Function**
 - Auto Power Down
 - Display Set
 - Trigger Output
 - Memory Guard
- Language**

Manages settings for speakers



Speaker Setup items

Auto Setup	Optimizes the speaker configuration automatically.
Manual Setup	Manually adjusts parameters for speakers.

Automatic speaker setup

Auto Setup

Optimizes the speaker configuration automatically using YPAO (p. 32).

Manual speaker setup

Manual Setup

The following parameters can be specified manually.

Power Amp Assign	Adds the extra speakers to the 7.1-channel speaker connection.
Configuration	Manually manages speaker configuration, such as speaker size (sound production capacity), and bass audio processing.
Distance	Manually adjusts the output of each speaker based on distance to the listening position.
Level	Manually adjusts the volume of each speaker.
Parametric EQ	Selects an equalizer to adjust speaker output characteristics.
Test Tone	Generates test tones.

Power Amp Assign

In addition to the 7.1-channel speaker connection, various speaker configurations are possible using the presence speakers connection, bi-amp connection or Zone2 function (p. 17, p. 18).

Configuration

Adjusts the output characteristics of the speakers based on manually set parameters.

In the "Configuration," you can select the speaker size characteristic (Large or Small). Select the size (sound reproduction capacity) that matches your speakers.

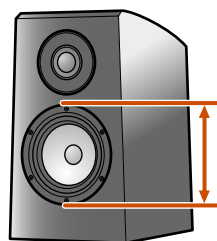

Woofer diameter
 • 16 cm or larger → Large
 • 16 cm or smaller → Small

When speaker size is set to "Small," low-frequency components of the speakers that you configured are produced from the subwoofer (or from the front speakers if there is no subwoofer).

Front

Selects the size (sound reproduction capacity) of the front speakers. 🌟1

Large	Select this for large speakers. The front speakers will produce all of the front channel frequency components.
Small (Default)	Select this for small speakers. The subwoofer will produce front channel low-frequency components. 🌟2

Center

Selects the size of the center speakers.

Large	Select this when a large center speaker is connected.
Small (Default)	Select this when a small center speaker is connected.
None	Select this when there is no center speaker. The front speakers will produce center channel audio.

Surround

Selects the size of the surround speakers.

Large	Select this when the surround speakers are large.
Small (Default)	Select this when the surround speakers are small.
None	Select this when no surround speakers are connected. The front speakers will produce surround channel audio signals.

- When set to "None," no sound is produced from the surround back speaker even if that speaker is connected.
- When set to "None," the sound programs will change to Virtual CINEMA DSP mode.

Surround Back

Selects the size of the surround back speakers.

Largex1	Select when one large surround back speaker is connected.
Largex2	Select when two large surround back speakers are connected.
Smallx1	Select when one small surround back speaker is connected.
Smallx2 (Default)	Select when two small surround back speakers are connected.
None	Select this when no surround back speakers are connected.

- When there are no surround speakers are connected, the setting will automatically change to "None."
- You can set surround back audio signals, including from the playback source, to be mixed down and produced from a single speaker (6.1-channel layout) or produced from left and right surround speakers (5.1-channel layout).

Front Presence

Specify connection of front presence speakers.

Use (Default)	Select this when front presence speakers are connected.
None	Select this when front presence speakers are not connected.

🌟 1: When "Subwoofer" is set to "None," you can only choose "Large." If the front speaker setting is "Small" and you change "Subwoofer" to "None," it will automatically change to "Large."

🌟 2: You can set the low-frequency components of audio signals transmitted from the front speakers to the subwoofer by using "Bass Cross Over."

Subwoofer

Confirms the subwoofer.

Use (Default)	Select this when subwoofer is connected. During playback, the subwoofer will produce audio from the LFE (low-frequency effect) channel and bass audio from other channels. 🌟1
None	Select this when subwoofer is not connected. The front speakers will produce audio from the LFE (low-frequency effect) channel and bass frequency audio from other channels.

Phase

Sets the phase of the subwoofer if the bass audio is lacking or unclear.

Normal (Default)	Does not change the subwoofer phase.
Reverse	Reverses the subwoofer phase.

Extra Bass

Allows the front channel low-frequency components to be produced exclusively by the subwoofer, or by both the subwoofer and the front speakers.

Off (Default)	Depending on the size of the front speakers, either the front speakers or the subwoofer produce the front channel low-frequency components.
On	The subwoofer and the front speakers produce the front channel low-frequency components.

When “Subwoofer” is set to “None” or “Front” is set to “Small,” “Extra Bass” is disabled.

Bass Cross Over

Sets the lower limit of low-frequency component which is produced from speakers of which the size is set to “Small.” A frequency sound which is lower than the specified frequency will be produced from the subwoofer or the front speakers. 🌟2

40Hz	110Hz
60Hz	120Hz
80Hz (Default)	160Hz
90Hz	200Hz
100Hz	

Distance

Adjusts the timing at which the speakers produce audio so that sounds from the speakers reach the listening position at the same time.

Selecting adjustment units

Use **[Left]Cursor Δ / ▽** to select the unit for distance (meters or feet), and press **[Enter]**.

Setting distances for each speaker

Use **[Left]Cursor Δ / ▽** to select the speaker you want to configure, and press **[Enter]**. Then use **[Left]Cursor < / >** to set the distance from the speaker to your listening position.

Adjustable range	1.0 ft to 80.0 ft (0.30 m to 24.0 m)
Default setting	10.0 ft (3.00 m) (Front L/Front R/Center/Surround L/Surround R/Surround Back L/Surround Back R/Front Presence L/Front Presence R/Subwoofer)
Adjustment increments	0.2 ft (0.05 m)

Level

Separately adjusts the volume of each speaker.

Use **[Left]Cursor Δ / ▽** to select the desired speaker, and press **[Enter]**. Then use **[Left]Cursor < / >** to adjust the volume for the selected speaker.

Adjustable range	-10.0 dB to +10.0 dB
Default setting	0.0 dB (Front L/Front R/Center/Surround L/Surround R/Surround Back L/Surround Back R/Front Presence L/Front Presence R/Subwoofer)
Adjustment increments	0.5 dB

🌟 1: Enabling “Extra Bass” allows both the subwoofer and the front speakers to produce bass audio.

🌟 2: If your subwoofer has a volume control or a crossover frequency control, set the crossover frequency to maximum and the volume to half (or slightly less).

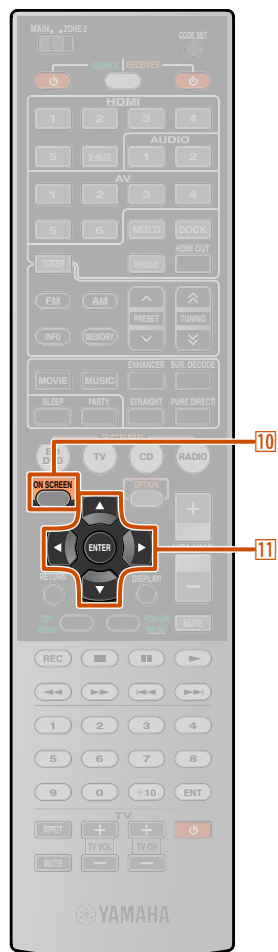

- 10 ON SCREEN**
- 11 Cursor Δ / ∇ / \triangleleft / \triangleright**
- 11 ENTER**

Parametric EQ

Adjusts sound quality of tone using a parametric equalizer.

PEQ Select

Select an equalizer type.

Manual	Manually adjust equalizer sound.
Flat	Adjust individual speakers to achieve the same characteristics. Select this option if speakers offer the same quality.
Front	Adjust individual speakers to achieve the same characteristics as the front left and right speakers. Select this option if front left and right speakers offer significantly greater quality than other speakers.
Natural	Adjust all speakers to achieve a natural sound. Select this if high-frequency sounds seem too strong when "PEQ Select" is set to "Flat."
Through (Default)	Disable the equalizer.

PEQ Data Copy

Select 1 of the 3 parametric equalizer types acquired with automatic setup and manually copy that information to the manual adjustments.

Flat > Manual	Copy the "Flat" parametric equalizer information acquired with automatic setup.
Front > Manual	Copy the "Front" parametric equalizer information acquired with automatic setup.
Natural > Manual	Copy the "Natural" parametric equalizer information acquired with automatic setup.

Front L / Front R / Center / Surround L / Surround R / Surround Back L / Surround Back R / Front Presence L / Front Presence R

The parametric equalizer can be used to manually adjust sound quality for individual speakers. Set "PEQ Select" to "Manual" and use "PEQ Data Copy" to copy information acquired with automatic setup. This information can be used as a basis for performing manual adjustments.

- 1 Use **11**Cursor Δ / ∇ repeatedly to select "Band / Gain," "Freq. / Gain," or "Q / Gain" and press **11**ENTER.**
- 2 Use **11**Cursor \triangleleft / \triangleright repeatedly to adjust the parameter and use **11**Cursor Δ / ∇ repeatedly to adjust the gain.**
- 3 Press **11**ENTER to exit the edit window.**
- 4 Repeat steps 1 to 3 to configure other parameters.**

To reset all parameter settings for the selected speaker, select "Reset to Flat" and press **11**ENTER.

- 5 Press **10**ON SCREEN to close the menu.**

Test Tone

Turns the test tone generator on or off.

Off (Default)	Does not generate test tones.
On	Generates test tones. While "On" is selected, test tones are produced constantly.

You can use the test tone in a variety of circumstances. For example, you can adjust the volume balance settings for each speaker, or whenever you adjust the settings on the internal parametric equalizer, you can listen to the actual effect while operating this unit. Turn the test tone off when you have finished making adjustments.

Setting the audio output function of this unit



Sound Setup items

Lipsync	Adjusts the delay between video and audio output.
Dynamic Range	Selects the dynamic range adjustment method for Dolby Digital and DTS playback.
Max Volume	Sets the maximum volume for this receiver.
Initial Volume	Sets the initial volume for when this receiver is turned on.
Adaptive DSP Level	Adjusts the level of DSP effect in conjunction with the volume level.

Synchronizing audio/video output

Lipsync

Adjusts the delay between audio and video output (Lipsync function).

Mode

Selects a compensation method for the delay between audio and video output.

Auto (Default)  1	When connecting to a TV via HDMI, automatically adjusts output timing if the TV supports an automatic lipsync function.
Manual	Manually adjusts the correction time. Select this when the monitor does not support the automatic lipsync function.

Delay

Adjustable range	0 ms to +250 ms
Default setting	0 ms
Adjustment increments	1 ms

Auto-adjusting Dolby Digital and DTS dynamic range

Dynamic Range

Selects the dynamic range adjustment method for audio bitstream (Dolby Digital and DTS) signal playback.

MAX (Default)	Produces audio without adjusting the dynamic range.
STD	Adjusts the dynamic range for optimum volume for regular home use.
MIN/AUTO	(MIN) Sets the dynamic range suitable for low volume or a quiet environment, such as at night, for bitstream signals except for Dolby TrueHD signals. (AUTO) Adjusts the dynamic range for Dolby TrueHD signals based on input signal information.

Setting the maximum volume

Max Volume

Specify the maximum volume level so that sound is not too loud. The default setting of +16.5 dB produces the highest volume.

Adjustable range	-30.0 dB to +16.5 dB (maximum volume)
Default setting	+16.5 dB
Adjustment increments	5.0 dB

 1: This setting is effective at the HDMI OUT jack selected by using **18** HDMI OUT.

Setting the startup volume

Initial Volume

Sets the initial volume for when this receiver is turned on. When this parameter is set to “Off,” the volume is set at the level when the receiver last entered standby mode. 1

Adjustable range	Off, Mute, -80 dB to +16.5 dB
Default setting	Off
Adjustment increments	0.5 dB

Adjusting DSP effect and volume level

Adaptive DSP Level

Automatically adjust the level of DSP effect in conjunction with the volume level.

Off	Disables automatic adjustment of the level of DSP effect.
On (Default)	Adjusts the degree of DSP effect in conjunction with volume level. The higher the volume level, the less the DSP effect applied. The lower the volume level, the greater the DSP effect applied.

Setting this unit's video output function



Video Setup items

Analog to Analog Conversion	Enable or disable video conversion between analog video jacks.
Processing	Enable or disable adjustment of resolution and aspect ratio for video signal converted to HDMI video.

Analog-to-analog video conversion

Analog to Analog Conversion

Enables or disables video conversion between analog video jacks.

Off	Disables video conversion between analog video jacks.
On (Default)	Enables video conversion between analog video jacks.

- Analog-to-HDMI video conversion is always possible unless video signals are being input at the HDMI input jacks or 1080p-resolution analog video signals are being input ([p. 113](#)).
- This unit does not convert 480 line video signals and 576 line video signals interchangeably.
- 480p-, 576p-, 1080i- and 720p-resolution video signals can not be output at the VIDEO MONITOR OUT jack ([p. 113](#)).
- The converted video signals are only output at the MONITOR OUT jacks.
- When composite video signals from a VCR are converted into component video signals, the picture quality may suffer depending on your VCR.
- Unconventional signals input at the composite video jacks cannot be converted or may be output abnormally. In such cases, set “Analog to Analog Conversion” to “Off.”

1 : When you set “Max Volume” at a lower level than “Initial Volume,” “Max Volume” has priority.

Adjusting resolution and aspect ratio with conversion of video signal to HDMI

Processing

Adjust resolution and aspect ratio with conversion of video input to HDMI video (upscaling).

Off (Default)	Resolution and aspect ratio are not adjusted with processing.
On	Resolution and aspect ratio are adjusted with processing.

Resolution

Auto (Default)	Automatic upscaling in accordance with TV resolution.
480p	Upscaling to 480p (576p).
720p	Upscaling to 720p.
1080i	Upscaling to 1080i.
1080p	Upscaling to 1080p.
Through	No upscaling.

- The 720p-, 1080i- and 1080p-resolution video signals cannot be upscaled (p. 113).
- When a TV is connected to this unit via the HDMI jack, this unit automatically detects a resolution that the TV supports. Only the detected resolution can be selected.
- If this unit cannot detect the resolution that the TV supports, set “MON.CHK” in the Advanced Setup menu to “SKIP” (p. 97) and try again.

Aspect

Through (Default)	The aspect ratio of HDMI video signal sources is not adjusted.
16:9 Normal	Transmits 4:3 aspect ratio video signals to a 16:9 TV with black bands on either side of the screen.

- The Aspect setting is automatically disabled when “Resolution” is set to “Through.”
- The Aspect setting is automatically disabled for video input with aspect ratios other than 4:3.
- Changing the aspect ratio of 720p, 1080i, or 1080p has no effect.

Setting HDMI functions



HDMI Setup items

HDMI Control	Turns the HDMI Control on or off.
Control Select	Choose an HDMI OUT jack on which HDMI Control function is enabled.
ARC (Audio Return Channel)	Turns the Audio Return Channel function on or off.
TV Audio Input	Chooses automatically selected audio input in conjunction with TV operation when the HDMI Control is turned on.
Audio Output	Specifies whether or not audio signal is output through this unit and a TV connected via the HDMI OUT 1-2 jacks.
Standby Through 	Turns the Standby Through function on or off.

 1: This item appears depending on “HDMI Control!”

Receiver operation via TV (HDMI Control)

HDMI Control

Set the HDMI Control function to “On” to operate devices connected via HDMI. If the TV or other external components support HDMI Control (e.g., Panasonic VIERA Link), you can use the remote controls of those devices to operate some of this unit’s functions, and to synchronize this unit with the operation of those devices.

Refer to “Using the HDMI Control function” (p. 99) for setting instructions.

Off (Default)	Sets HDMI Control to “Off.”
On	Sets HDMI Control to “On.” 

If this unit is connected to HDMI devices that do not support the HDMI Control function, these functions will not operate.

Selecting an HDMI OUT jack for the HDMI Control function

Control Select

Select the HDMI OUT jack that utilizes the HDMI Control function.

Refer to “Using the HDMI Control function” (p. 99) for setting instructions.

Out1(TV1)	Applies the HDMI Control function for the HDMI OUT 1 jack.
Out2(TV2)	Applies the HDMI Control function for the HDMI OUT 2 jack.

Listening to TV audio via single HDMI cable (Audio Return Channel)

ARC (Audio Return Channel)

You can enable or disable the Audio Return Channel function. When using a TV that supports Audio Return Channel function and the function is enabled, the TV’s audio output is transmitted to this unit via an HDMI cable.

The TV audio input to this unit is regarded as the input source selected in “TV Audio Input.” 
By means of this function, you do not need to connect the TV’s audio output (digital audio output or analog audio output) to the unit.

Off (Default)	Sets the Audio Return Channel to “Off.”
On	Sets the Audio Return Channel to “On.”

When the TV audio is input to the unit using Audio Return Channel, “TV” is displayed on the front panel display.



- “ARC (Audio Return Channel)” is enabled only for the HDMI OUT 1 or 2 jack selected with “Control Select.”
- Refer to “Single HDMI cable input to TV audio with Audio Return Channel function” (p. 101) for setting instructions.

Selecting an input source to assign audio input for the TV

TV Audio Input

Select the input source that receives audio signals from TV while the HDMI Control function is on.

When using a TV that supports Audio Return Channel function and the function is enabled, the audio input for the TV is assigned to the input source selected here. 

TV1

Audio input	AV1-6 or AUDIO1-2
Default setting	AV4

TV2

Audio input	AV1-6 or AUDIO1-2
Default setting	AV1

- “TV Audio Input” is enabled only for the HDMI OUT 1 or 2 jack selected with “Control Select.”
- Refer to “Switching the input source on this unit automatically when listening to TV audio” (p. 100) for instructions.

 1: When the HDMI Control is “On,” the Standby Through function is automatically enabled. When this unit enters standby mode, the audio and video signals from the last-selected HDMI input source will continue to be transmitted to the TV. The HDMI input source can only be changed using the remote control.

 2: While the Audio Return Channel function is on, the jack selected for the input source cannot be used.

Specify whether or not audio signal is output through this unit and a TV

Audio Output

Choose whether audio is played back through this unit or through a TV.

Amp

Specify whether or not audio signal is output through this unit.

Off	Audio is not output through this unit.
On (Default)	Audio is output through this unit. When this setting is selected, audio from the external component is output in a format compatible with this unit.

OUT1

Specify whether or not audio signal is output through a TV connected via the HDMI OUT 1 jack.

Off (Default)	Audio is not output through a TV connected via the HDMI OUT 1 jack.
On	Outputs audio through a TV connected via the HDMI OUT 1 jack. When this setting is selected, audio from the external component is output in a format compatible with the TV.

OUT2

Specify whether or not audio signal is output through a TV connected via the HDMI OUT 2 jack.

Off (Default)	Audio is not output through a TV connected via the HDMI OUT 2 jack.
On	Outputs audio through a TV connected via the HDMI OUT 2 jack. When this setting is selected, audio from the external component is output in a format compatible with the TV.

Transmitting HDMI audio/video to the TV during standby mode (Standby Through)

Standby Through

This function allows audio/video signals from HDMI inputs to continue to be transmitted to a TV when this unit is in standby mode.

When the Standby Through function is “On,” audio/video signals continue to be output to the TV from the last HDMI input source before this unit enters standby mode. The HDMI input source can be selected using **[4]HDMI1-5** or **[4]V-AUX** in standby mode.

Off (Default)	Sets Standby Through to “Off.”
On	Transmits audio/video signals from the selected HDMI input source to the TV.

- When “HDMI Control” is “On,” Standby Through function is automatically enabled and “Standby Through” is not displayed.
- When the Standby Through function is on, the HDMI Through/iPod Charge indicator on the front panel lights during the standby mode. This unit consumes approximately 3 W of power.

Setting this unit's multi-zone function



Multi Zone Setup items

Zone2 Set	Adjusts Zone2 volume level.
Party Mode Set	Enable or disable the party mode function.

Adjusting Zone2 volume

Zone2 Set

Max Volume

Specify the maximum volume level in Zone2 so that sound is not too loud.

Adjustable range	-30.0 dB to +16.5 dB (maximum volume)
Default setting	+16.5 dB
Adjustment increments	5.0 dB

Initial Volume

Specify the initial volume level in Zone2 when this unit is turned on.

Adjustable range	Off, Mute, -80 dB to +16.5 dB
Default setting	Off
Adjustment increments	0.5 dB

Setting the party mode

Party Mode Set

In party mode, the main zone sources can be played in Zone2 simultaneously ([p. 104](#)). Select “Zone2,” and then select “Enable” or “Disable.”

Enable (Default)	Enables the party mode function.
Disable	Disables the party mode function.

Making the receiver easier to use



Function Setup items

Auto Power Down	This unit enters standby mode if no operations are performed.
Display Set	Specifies menu items displayed on TV screen and the front panel.
Trigger Output	Specifies TRIGGER OUT jack function.
Memory Guard	Protects some settings against accidental modification.

Goes enter standby mode automatically when you leave it without operating

Auto Power Down

If you do not operate this unit or use the remote control for an extended period of time, it will automatically go into standby mode (Auto Power Down function). This function's default setting is "Off." When you want to enable this function, set the amount of time to pass before this unit will enter standby.

4hours	Goes into standby mode, when you have not operated this unit for four hours.
8hours	Goes into standby mode, when you have not operated this unit for eight hours.
12hours	Goes into standby mode, when you have not operated this unit for twelve hours.
Off (Default)	Auto Power Down function is disabled.

This unit starts a countdown of 30 seconds before entering the standby mode. Pressing any key of the remote control during the countdown cancels entering the standby mode and reset the timer.

Specifying menu display

Display Set

Specify front panel display brightness and TV screen wall paper.

Front Panel Display

Specify front panel display brightness and message scroll pattern.

Dimmer	Adjustable range: -4 - 0 Reduce brightness of the front panel display. As the value is lowered, the panel display darkens.
Scroll	Selects the manner in which display scrolls when the total number of characters exceeds the display area on the front panel display. Select "Continue" for continuous scrolling of all characters. Select "Once" to scroll through all characters once and then halt scrolling for display of only the first 14 characters.

Wall Paper

Specify the wall paper displayed on the TV screen when no video signal is input. Select one that you prefer.

Picture	Displays an image on the TV screen when there is no video signal.
Gray	Displays a gray background on the TV screen when there is no video signal.

Setting TRIGGER OUT functions

Trigger Output

Sets the TRIGGER OUT jack to function synchronized with power status of each zone or input switching.

Trigger Mode

Specify the condition for the TRIGGER OUT jack to function.

Power (Default)	The TRIGGER OUT jack functions synchronized with the power status of the zone specified with "Target Zone."
Source	The TRIGGER OUT jack functions synchronized with the input switching in the zone specified with "Target Zone." Electronic signal is transmitted according to the setting made in "Target Source."
Manual	Select this to manually switch the output level for electronic signal transmission with "Manual."

Target Zone

Specify the zone with which the TRIGGER OUT jack functions synchronized.

Main (Default)	When "Trigger Mode" is set to "Power," electronic signal transmission is synchronized with power status of the main zone. When "Trigger Mode" is set to "Source," electronic signal transmission is synchronized with input switching in the main zone.
Zone2	When "Trigger Mode" is set to "Power," electronic signal transmission is synchronized with power status of Zone2. When "Trigger Mode" is set to "Source," electronic signal transmission is synchronized with input switching in Zone2.
All	When "Trigger Mode" is set to "Power," electronic signal transmission is synchronized with power status of the main zone or Zone2. When "Trigger Mode" is set to "Source," electronic signal transmission is synchronized with input switching in the main zone or Zone2.

Target Source

Specify the output level of the electronic signal transmitted with each input switching.

Low	Stops the electronic signal transmission when you switch to the input source specified in this option.
High (Default)	Transmits the electronic signal when you switch to the input source specified in this option.

This setting is available only when "Trigger Mode" is set to "Source."

Manual

Manually switch the output level for electronic signal transmission. This setting can also be used to confirm proper function of the external component connected via the TRIGGER OUT jack.

Low	Stops the electronic signal transmission.
High (Default)	Transmits the electronic signal.

This setting is available only when "Trigger Mode" is set to "Manual."

Prohibiting setting changes

Memory Guard

Prohibits setting changes to prevent careless changes being made to the settings on Setup menu.

Off (Default)	Settings are not protected.
On	Prohibits changes to the settings on Setup menu until it is returned to "Off." While set to "On," the unit displays "Memory Guard!" when an attempt is made to change the settings.

Language

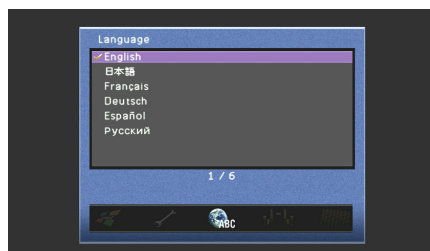

Select the language used for display of menus and messages. 1
 Choices: English (English), 日本語 (Japanese), Français (French),
 Deutsch (German), Español (Spanish),
 Русский (Russian)

1 : Content window information is displayed in the language in which that information was released.

Confirming information of this unit (Information menu)

A variety of information for this unit can be displayed.

Selecting information

1 Press **[10] ON SCREEN**.

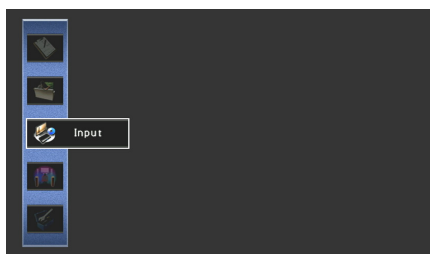

2 Use **[11] Cursor Δ / ▽** to select “Information” and press **[11] ENTER**.

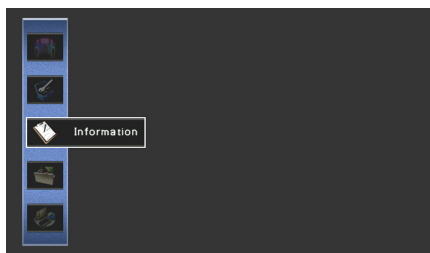

3 Use **[11] Cursor < / >** to select an Information menu and press **[11] ENTER**.



Audio information

Displays information on the current audio signal.

Format	Signal format. When this unit is unable to detect a digital signal, it automatically switches to analog input.
Sampling	The number of samples taken per second from a continuous signal to make a discrete signal.
Channel	The number of source channels in the input signal (front/surround/LFE). For example, a multi-channel soundtrack with 3 front channels, 2 surround channels and LFE is displayed as “3/2/0.1”.
Bitrate	The number of bits passing a given point per second.
Dialogue	The dialogue normalization level preset to the current input bitstream signal.

- “___” is displayed when this unit cannot display the corresponding information.
- Some high-definition audio bitstream contents may not include the discrete surround back left and right channel signals, but are encoded at a bitrate of 192 kHz.
- Even when direct bitstream output settings are applied, some players convert the Dolby TrueHD or Dolby Digital Plus bitstreams to the Dolby Digital bitstreams, while converting DTS-HD Master Audio or DTS-HD High Resolution Audio bitstreams to DTS bitstreams.

Video information

Displays information on the current video signal.

HDMI signal	Source video signal type and video signal output to this unit’s HDMI OUT 1-2 jacks.
HDMI Resolution	Input signal (analog or HDMI) and output signal (HDMI) resolution.
Analog Resolution	Resolution of the source video signal and the analog video signal output to this unit’s MONITOR OUT jacks.
HDMI Error	Error message for HDMI sources or connected HDMI devices (p. 105).

HDMI monitor

Displays information on the TV screen connected to this unit’s HDMI OUT 1-2 jacks.

Interface	Displays information on the current connection interface.
Video Resolution	Displays the frequency for each video resolution of the TV currently connected.

System information

Displays information on the current settings of “Remote ID,” “TV Format” and “Speaker Impedance.”

Zone information

Displays information on Zone2 settings.

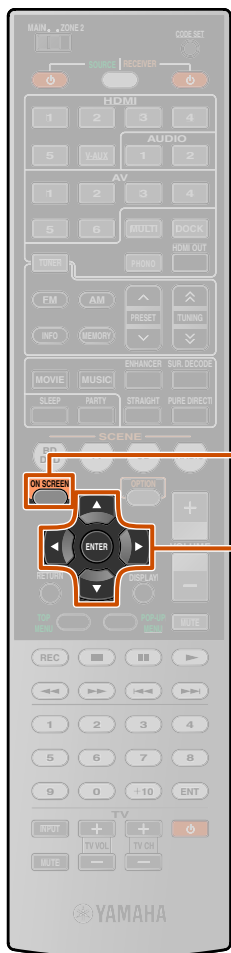

[10] ON SCREEN

[11] Cursor Δ / ▽ / < / >

[11] ENTER

Controlling other components with the remote control

You can operate an external component such as TV and DVD player with the remote control of this unit by setting the code for external component (remote control code). The remote control code can be set for each input source. Individual setting allows you to switch external components seamlessly depending on the selected input source.

Selecting input source connected to DVD player

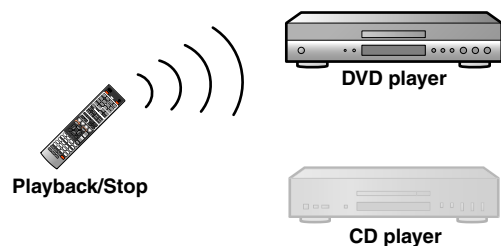

Selecting input source connected to CD player

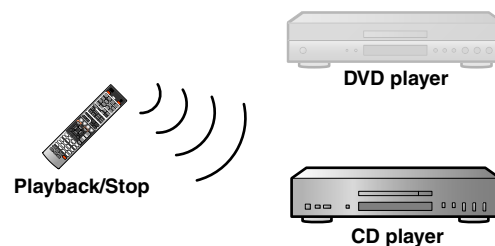

If you are unable to operate this unit after operating an external component, light up **16** SOURCE/RECEIVER in orange by pressing it, and then try operating the remote control again.

Keys connecting external components

The remote control keys for controlling external components are available only when the external components have corresponding control keys.

3 SOURCE

Switches an external component on and off.

11 Cursor, **11** ENTER, **11** RETURN

Operates the menus of external components.

12 DISPLAY

Switches an external component display.

12 External component operation keys

Functions as a recording or playback key of an external component, or a menu display key.

13 Numeric keys

Functions as numeric keys of an external component.

14 TV control keys

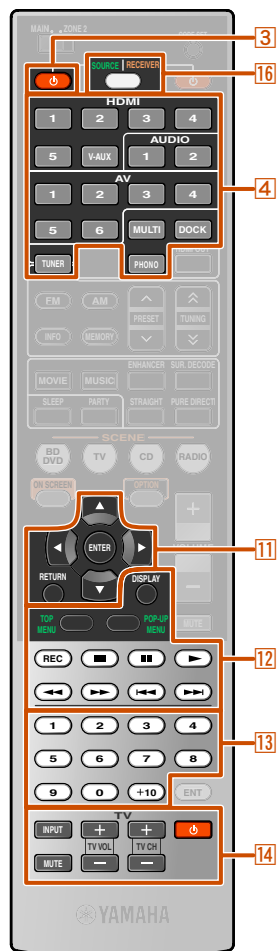

- 3** SOURCE
- 4** Input selector
- 11** Cursor
- 11** ENTER
- 11** RETURN
- 12** External component operation keys
- 12** DISPLAY
- 13** Numeric keys
- 14** TV control keys
- 14** INPUT
- 14** MUTE
- 14** TV VOL +/-
- 14** TV CH +/-
- 14**
- 16** SOURCE/RECEIVER

- 1** : When remote control codes for external components are registered with **4** Input selector or **14** (**14** TV control keys), the following operations are possible.
- When a TV remote control code is registered with **4** Input selector, the **11** Cursor, **13** Numeric keys and **14** TV control keys can be used to control the TV selected with

4 Input selector.

- When a remote control code for a device other than a TV is registered with **4** Input selector, keys including the **11** Cursor and **13** Numeric keys can be used to control external components, and the **14** TV control keys can be used to control the TV registered with **14** .

- When a TV remote control code is registered with **14** , only **14** TV control keys can be used to control the TV.





- 4 HDMI2
- 14 TV control keys
- 14
- 15 CODE SET

Default remote control code settings

The following remote control codes are assigned to input sources as factory default settings. For a complete list of available remote control codes, refer to “[Remote Control Code Search](#)” in the CD-ROM.

Input	Category	Manufacturer	Remote control code
HDMI1	Blu-ray player/recorder	Yamaha	2064
HDMI2	—	—	—
HDMI3	—	—	—
HDMI4	—	—	—
HDMI5	—	—	—
AV1	—	—	—
AV2	—	—	—
AV3	CD player	Yamaha	5095
AV4	—	—	—
AV5	—	—	—
AV6	—	—	—
AUDIO1	—	—	—
AUDIO2	—	—	—
V-AUX	—	—	—
PHONO	—	—	—
DOCK	—	—	—
TUNER	—	—	—

Registering remote control codes for external component operations

The following section describes how to register remote control code using an example of the registration of the remote control codes of a Yamaha BD player connected to HDMI2 jack.

- Perform each of the following steps within 1 minute. Settings will be automatically stopped if more than 1 minute passes since the last operation. To reset, repeat from step 2.
- Remote control code of an external component cannot be set from the name or model number of a unit. Use “[Remote Control Code Search](#)” in the CD-ROM to search the available remote control codes from the category or manufacturer of external components.
- If multiple remote control codes exist, first set the first code in the list, if it does not work then try the other codes.

- 1 Use “[Remote Control Code Search](#)” in the CD-ROM to search the available remote control codes from the category or manufacturer of external components.

“2064” can be used for a Yamaha BD player.

- 2 Press **15**CODE SET using a pointed object such as the tip of a ballpoint pen.

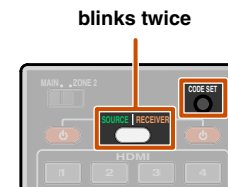

- 3 Press **4**HDMI2 to switch the input source to HDMI2.

Perform the following steps to register the selected input source here to the remote control code.

Continues to the next page

1 : When you want to register a remote control code to the **14**TV control keys, press **14** (**14**TV control keys) in step 3.



- 4 HDMl2
- 9 SCENE
- 13 Numeric keys
- 15 CODE SET
- 16 SOURCE/RECEIVER

4 Enter a remote control code “2064” using **13** Numeric keys. 1



Once the remote control code is registered successfully **16**SOURCE/RECEIVER will blink twice.

Registration successful: blinks twice
Registration failed: blinks 6 times

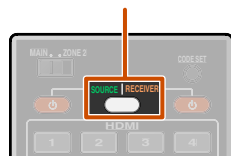

- If the registration fails, repeat from step 2.
- In case of an external component with multiple remote control codes, the other remote control codes may be supported. Repeat from step 2 with the other remote control codes.

5 To switch between BD player linked to scene selections, press **9**SCENE and at the same time press **4**HDMl2 and hold it for approximately 3 seconds.

Then you can operate the external components by switching the input source to HDMl2, or selecting HDMl2 in the registered scene.

Same steps for operating other external components, press **9**SCENE and at the same time press the input source key selected in step 3 and hold it for approximately 3 seconds.

Resetting all remote control codes

Resetting all remote control codes for external components to the initial factory settings.

Perform each of the following steps within 1 minute. Settings will be automatically stopped if more than 1 minute passes since the last operation. To reset, repeat from step 1.

1 Press **15**CODE SET using a pointed object such as the tip of a ballpoint pen.

blinks twice

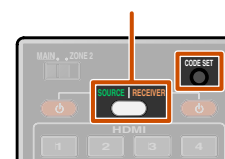

2 Press **16**SOURCE/RECEIVER on the remote control.

3 Enter “9981” using **13**Numeric keys.



Once the remote control code is reset successfully **16**SOURCE/RECEIVER will blink twice.

Reset successful: blinks twice
Reset failed: blinks 6 times

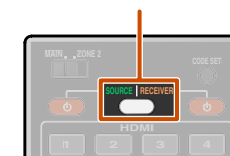

If setup fails, repeat from step 1.

1 : When you want to register a remote control code to the **14**TV control keys, enter the TV remote control code in step 4.

Extended functionality that can be configured as needed (Advanced Setup menu)

The Advanced Setup menu can be used for unit initialization and other useful extended functions. The Advanced Setup menu can be operated as follows.

Displaying/Setting the Advanced Setup menu

1 Switch this unit to the standby mode.

2 Press **MAIN ZONE**  while pressing and holding **STRAIGHT** on the front panel.

Release **STRAIGHT** when “ADVANCED SETUP” is displayed on the front panel display.

After a few seconds, the top menu items are displayed.

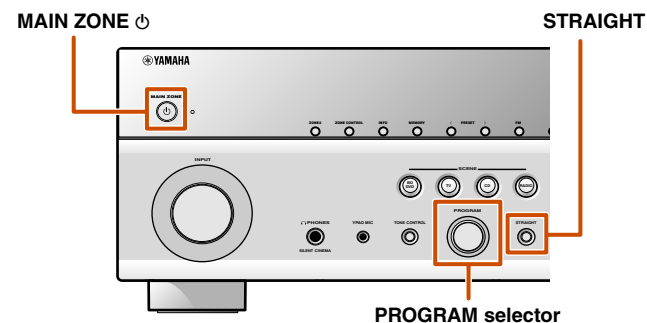

3 Rotate **PROGRAM** selector to select the item to be set from the following items.

In the Advanced Setup menu, you can set the following settings.

SP IMP.	Sets the impedance of speakers.
REMOTE ID	Changes the remote control ID of a receiver.
TV FORMAT	Specifies the TV's color encoding format.
MON.CHK	Removes the up-scaling limitation on HDMI video output.
TU  1	Selects one of the following FM/AM frequency steps.
INIT	Initializes various settings for this unit.

4 Press **STRAIGHT** repeatedly to select the value you want to change.

5 Switch this unit to the standby mode, and then switch it on again.

The settings become effective and the unit is powered on.

Setting the impedance of speakers



Changes the unit settings depending on the impedance of the speakers connected.  2

6ΩMIN	Select the impedance when 6 Ω speakers are connected.
8ΩMIN (Default)	Select the impedance when speakers above 8 Ω are connected.

 1: Asia and General models only.

 2: For detailed procedures of speaker impedance settings, refer to “Changing speaker impedance” ([p. 18](#)).



- 13** Numeric keys
- 15** CODE SET
- 16** SOURCE/RECEIVER

Avoiding crossing remote control signals when using multiple Yamaha receivers



The remote control of the unit can only receive signals from a receiver which has an identical ID (remote control ID). When using multiple Yamaha AV receivers, you can set each remote control with a unique remote control ID for its corresponding receiver. On the contrary, if you are setting the same remote control ID for all receivers, you can use one remote control to operate 2 receivers.

ID1 (Default)	Receives the remote control signals set in ID1.
ID2	Receives the remote control signals set in ID2.

ID1 is set for both remote control and receiver by default. To avoid crossing remote control, change the remote control ID for both remote control and receiver.

Changing TV format



Change the color encoding format of OSD to PAL or NTSC, to match the format used by the TV connected via the HDMI OUT 1-2 or VIDEO (MONITOR OUT) jack.

Removing HDMI video output up-scaling limits



Removes the up-scaling limitation on video resolution when this unit and a TV are connected via HDMI jacks. If a resolution supported by the monitor cannot be detected when configuring the up-scaling settings, this setting will remove the output limitation.

YES (Default)	Video output signals of a resolution not supported by the TV will not be transmitted.
SKIP	This unit ignores the TV's support capability and transmits input video signals to the TV.

■ To change the remote control ID

Perform each of the following steps within 1 minute. Settings will be automatically stopped if more than 1 minute passes since the last operation. To reset, repeat from step 1.

- 1** Press **15**CODE SET using a pointed object such as the tip of a ballpoint pen.
- 2** Press **16**SOURCE/RECEIVER.
- 3** Enter the desired remote control ID code.

To switch to ID1:
Enter "5019" using **13**Numeric keys.

To switch to ID2:
Enter "5020" using **13**Numeric keys.

Once the remote control code is registered successfully **16**SOURCE/RECEIVER will blink twice.

Registration successful: blinks twice
Registration failed: blinks 6 times

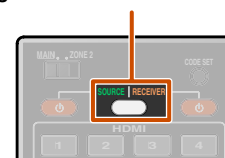

- If setup fails, repeat from step 1.
- Returns to ID1 after the remote control code is initialized ([p. 95](#)).

Changing FM/AM frequency steps (Asia and General models only)



You can select one of the following FM/AM frequency steps: 1

AM10/FM100	You can adjust the AM frequency by steps of 10kHz and FM by steps of 100kHz.
AM9/FM50 (Default)	You can adjust the AM frequency by steps of 9kHz and FM by steps of 50kHz.

Initializing various settings for this unit



Initializes various settings stored in this unit and sets it back to default.

Select the items to be initialized from the following.

DSP PARAM	Initializes all parameters for the sound programs.
VIDEO	Resets video conversion settings (resolution/aspect ratio) in the Setup menu.
ALL	Resets this unit to default factory settings.
CANCEL (Default)	Does not initialize.

When an option other than CANCEL is selected, the applicable default settings will be restored when the unit switches to standby mode.

1 : For details on setting FM/AM frequency steps, refer to “FM/AM tuning” (p. 55).

Using the HDMI Control function

This unit supports the HDMI Control function, which allows you to operate external components via HDMI. If devices that support HDMI Control (e.g., Panasonic VIERA Link-compatible TVs, DVD/Blu-ray Disc players, etc.) are connected 1, remote controls for those devices can be used to perform the following operations:

- Power synchronization (on/standby)
- Volume control, including Mute
- Changing the volume of the audio output signal device (either the TV or this unit)

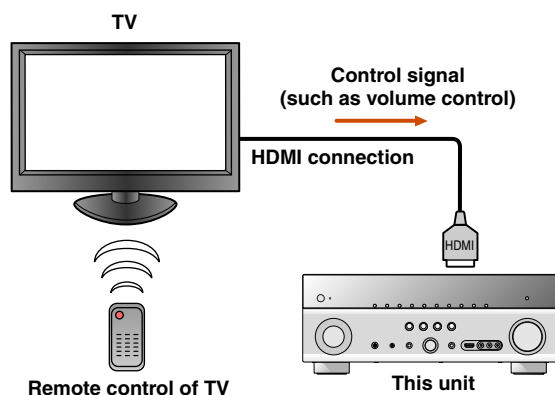

NOTE

The following is an example of how to connect this unit, a TV, and a DVD/BD player. Follow the instructions in your TV and DVD/BD player manuals, as well as the ones written below.

- Set the TV's HDMI Control function to "On"
- Follow the AV amplifier connection instructions, and connect this unit to the TV

1 Connect the TV that supports the HDMI Control function to this unit's HDMI output jack.

2 Connect the DVD/BD player that supports the HDMI Control function to this unit's HDMI input jack.

3 Turn on the TV and this unit.

Refer to the TV's instruction manual on how to operate external components.

4 Set the TV and this unit's HDMI Control function to "On."

This unit	Confirm that "HDMI Control" is set to "On" (e.g. p. 86) and select the HDMI OUT jack connected to the TV in "Control Select" (e.g. p. 86).  2
TV and DVD/BD player	Check the instruction manuals for those devices.

5 Turn the TV off.

Other synchronized HDMI Control devices are turned off with the TV. If they are not synchronized, turn them off manually.

6 Turn the TV on.

Confirm that this unit has turned on in conjunction with the TV. If it is still off, turn it on manually.

7 Change the TV's input setting to the input jack that is connected to this unit (e.g., HDMI1).

8 If DVD/BD player that supports the HDMI Control function are connected to this unit, turn them on.

This unit	Confirm that the input source for the DVD/BD players has been selected. If a different input source has been selected, change it manually.
TV and DVD/BD player	Confirm that the video signal from the player is being properly received by the TV.

Operations 1-8 will not be required more than twice.

9 Confirm that this unit is properly synchronized with the TV through the following operations by using the TV remote control.

- Power On/Off
- Volume Control
- Switching between audio output devices

If this unit is not synchronized to the TV's power operations, check that the HDMI Control function is set to "On" for both devices. If they will not properly synchronize, unplugging and re-plugging the devices and turning them on and off may solve the problem.

 1: We recommend that you use TVs and DVD/BD players from the same manufacturer whenever possible.

 2: The default setting for the HDMI Control function is "Off."

Switching the input source on this unit automatically when listening to TV audio

When the HDMI Control (see p. 99) is operating properly, the input source of this unit is automatically changed to match operations carried out on the TV.

When the TV is connected with HDMI OUT 1, the default input jack is AV4. If the AV4 optical digital jack is connected to the TV's audio output jack, then you can enjoy TV sound through this unit right away.

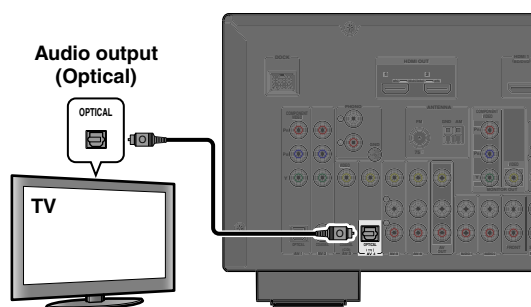

When the TV is connected with HDMI OUT 2, the default input jack is AV1. If the AV1 optical digital jack is connected to the TV's audio output jack, then you can enjoy TV sound through this unit right away.

To use other jacks to input audio signals from TV, carry out the following procedure.

1 Connect this unit and the TV with an HDMI cable.

2 Connect TV's audio output to this unit. The input jacks listed below are available to input TV's audio signals. Use the same jack type as used for the TV.

TV output jack	Input jack
Optical digital audio output	AV1 or AV4 (Default)
Coaxial digital audio output	AV2 or AV3
Analog stereo output	AV5, AV6, AUDIO1, or AUDIO2

Available input jacks

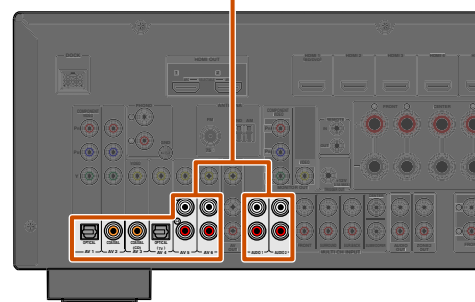

3 Press **ON SCREEN**.  1

4 Press **Cursor** Δ / ∇ repeatedly to select "Setup" and press **ENTER**.

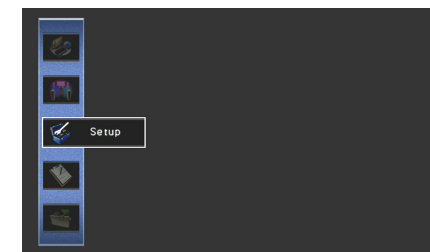

5 Press **Cursor** \leftarrow / \rightarrow repeatedly to select "HDMI" and press **ENTER**.



Continues to the next page



10 ON SCREEN

11 Cursor Δ / ∇ / \leftarrow / \rightarrow

11 ENTER

 1: Refer to the "Setting various functions (Setup menu)" (see p. 78) for details on the Setup menu.



- 10** ON SCREEN
- 11** Cursor $\Delta / \nabla / \triangleleft / \triangleright$
- 11** ENTER

- 6** Make sure that “HDMI Control” is “On”
When “HDMI Control” is set to “Off,” press **11**ENTER and **11**Cursor Δ / ∇ to set to “On.”
- 7** Press **11**Cursor ∇ to select “Control Select” and press **11**ENTER.
- 8** Use **11**Cursor Δ / ∇ to select the HDMI OUT jack connected to the TV.
- 9** Press **11**Cursor ∇ to select “TV Audio Input” and press **11**ENTER.
- 10** Use **11**Cursor Δ / ∇ to select the input jack connected in step 2.
- 11** Press **10**ON SCREEN when you have finished changing the settings.

If the TV hereafter transmits audio output signals, this unit will automatically switch to the input source chosen in step 10.

Single HDMI cable input to TV audio with Audio Return Channel function

When using a TV that supports HDMI functions and Audio Return Channel function, audio/video output from this unit to the TV or audio output from the TV to this unit can be transmitted through a single HDMI cable (Audio Return Channel function). Audio signals transmitted from the TV to this unit can be assigned to any input source.

- 1** Connect this unit and the TV with an HDMI cable.

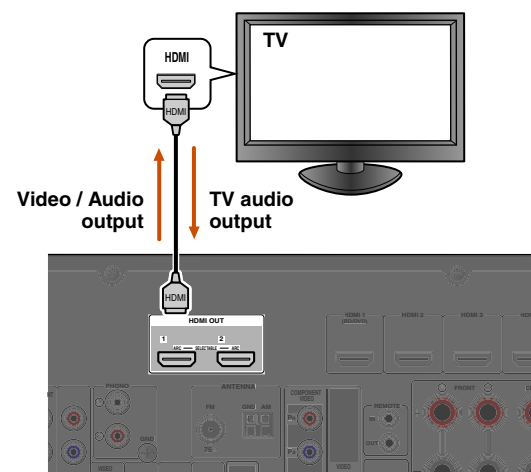

- 2** Press **10**ON SCREEN. 1

- 3** Press **11**Cursor Δ / ∇ repeatedly to select “Setup” and press **11**ENTER.

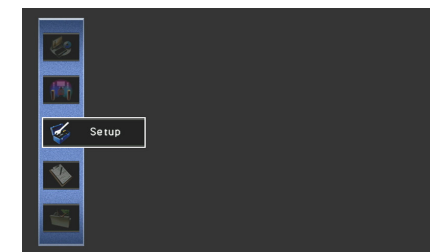

- 4** Press **11**Cursor $\triangleleft / \triangleright$ repeatedly to select “HDMI” and press **11**ENTER.



Continues to the next page

1: Refer to the “Setting various functions (Setup menu)” ([p. 78](#)) for details on the Setup menu.

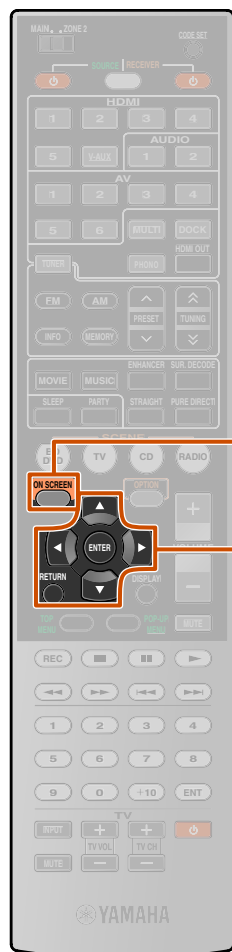

- 10 ON SCREEN**
- 11 Cursor Δ / ∇**
- 11 ENTER**
- 11 RETURN**

- 5 Make sure that “HDMI Control” is “On.”**
When “HDMI Control” is set to “Off,” press **11 ENTER** and **11 Cursor Δ / ∇** to set to “On.”
- 6 Press **11 Cursor ∇** to select “Control Select” and press **11 ENTER**.**
- 7 Use **11 Cursor Δ / ∇** to select the HDMI OUT jack connected to the TV.**
- 8 Press **11 Cursor ∇** to select “TV Audio Input” and press **11 ENTER**.**
- 9 Use **11 Cursor Δ / ∇** to select the input source to which the HDMI audio signals will be assigned, and press **11 RETURN**.**
- 10 Press **11 Cursor ∇** to select “ARC (Audio Return Channel)” and press **11 ENTER**.  1**
- 11 Press **11 Cursor ∇** to select “On.”**
The Audio Return Channel function will turn on.
- 12 Press **10 ON SCREEN** to close the Setup menu.**

If the TV hereafter transmits audio output signals, this unit will automatically switch to the input source chosen in step 9.

 1 : While the Audio Return Channel function is on, the jack selected for the input source cannot be used.

Using multi-zone configuration

This unit allows you to configure a multi-zone audio system. The Zone2 feature allows you to set this unit to reproduce separate input sources in the main zone and the second zone (Zone2). You can control this unit from the second zone using the supplied remote control.

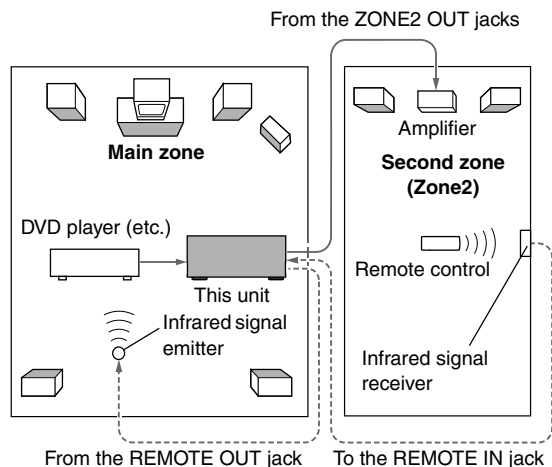

Only analog signal can be sent to Zone2. If you want to output sound from Zone2, connect an external component to AV5-6, AUDIO1-2, or VIDEO AUX by analog connection. For example, if you want to output sound from an HDMI DVD player in Zone2, you must connect the component to this unit by both HDMI and analog connections.

Connecting Zone2

You need the following additional equipment to use the multi-zone functions of this unit:

- An infrared signal receiver in the second zone.
- An infrared signal emitter in the main zone. This emitter transmits infrared signals from the remote control to a CD player or a DVD player, etc. in the main zone via the infrared signal receiver in the second zone.
- An amplifier and speakers in the second zone.

Since there are many possible ways to connect and use this unit in a multi-zone configuration, we recommend that you consult with your nearest authorized Yamaha dealer or service center about the Zone2 connections that best meet your requirements.

Using the external amplifier

An amplifier located in the secondary zone can be connected to this unit as shown below.

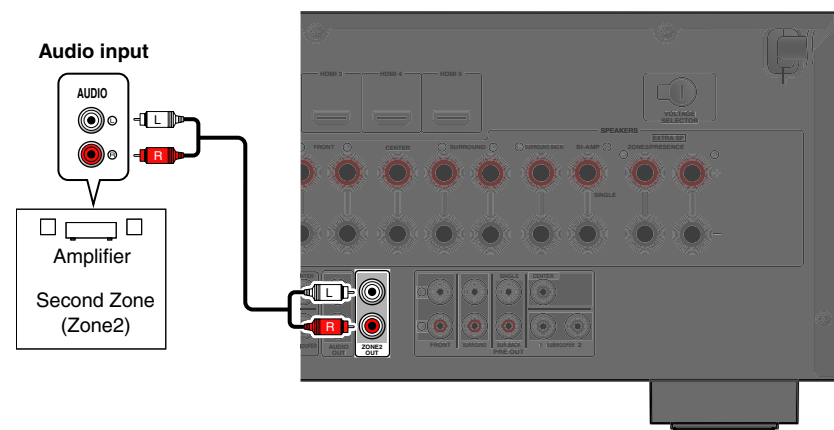

To avoid unexpected noise, DO NOT USE the Zone2 feature with CDs encoded in DTS.

Using the internal amplifier of this unit

Connect the speakers in the second zone to the EXTRA SP jacks directly ([p. 18](#)).

Using REMOTE IN/OUT jacks for multi-zone components

This unit is equipped with REMOTE IN and REMOTE OUT jacks. You can use these jacks to control this unit and other components from Zone2 ([p. 29](#)).

Some Yamaha models can be directly connected to the REMOTE jacks of this unit. These models may not require an infrared signal emitter. Up to 6 Yamaha components can be connected as shown below.

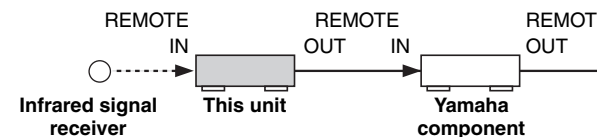

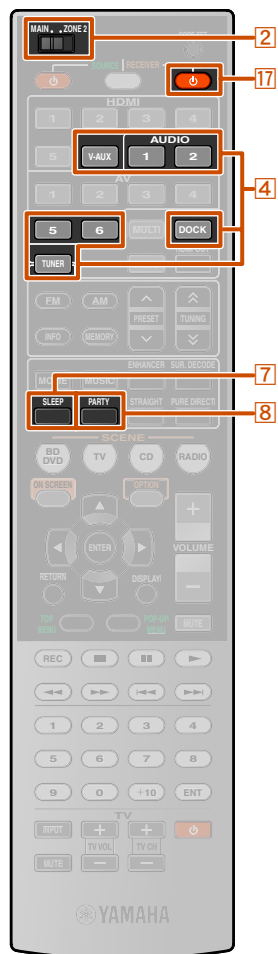

- 2 MAIN/ZONE2
- 4 Input selector
- 7 SLEEP
- 8 PARTY
- 17 RECEIVER

Controlling Zone2

The remote control can be used to select and control Zone2 devices. The available operations are as follows:

- Selecting the input source of Zone2.
- Tuning into FM or AM when “TUNER” is selected as the input source of Zone2.
- Adjust the volume of Zone2 devices (when connected via the built-in amplifier).

Activating the Zone2 operation mode

Set 2 MAIN/ZONE2 to ZONE2 before attempting to use the remote control to control Zone2 devices.

Operating Zone2

To enable and disable the audio output to Zone2

Press 17 RECEIVER.

To select an input source for Zone2

Press 4 Input selector.

To enable the sleep timer for Zone2

Automatically switch the Zone2 device to standby mode after a specified period of time has elapsed (sleep timer).

Press 7 SLEEP repeatedly to specify a time for the sleep timer function.



Using the party mode

Use this feature to play main zone sources in Zone2 simultaneously. This feature is useful when you want to play back main sources as background music in a home party, etc. When using the party mode, set “Party Mode Set” to “Enable” (p. 88).

Press 8 PARTY to turn on or off the party mode.

“PARTY MODE ON” or “PARTY MODE OFF” appears on the front panel display or the TV screen.

While this unit is in the party mode, the ZONE2

indicators turn on in the front panel display.

Input audio signals are mixed down to 2ch Stereo and output at the analog ZONE2 OUT jacks.

APPENDIX

Troubleshooting

Refer to the table below when this unit does not function properly.

If the problem you are experiencing is not listed below, or if the instructions below do not help, turn off this unit, disconnect the power cable, and contact the nearest authorized Yamaha dealer or service center.

General

Problem	Cause	Remedy	See page
The power will not turn on.	The protection circuitry operated 3 times consecutively.	As a safety precaution, when the protection circuitry operates 3 times consecutively, the capability to turn on the power is disabled. Contact your nearest Yamaha dealer or service center to request repair.	—
The unit enters standby mode soon after the power is turned on.	The power cable is not completely inserted.	Connect the power cable properly to an AC wall outlet.	—
	(When this unit is turned back on and “CHECK SP WIRES!” is displayed.) The protection circuitry has been activated because this unit was turned on while a speaker cable was shorted.	Make sure that all speaker cables between this unit and speakers are connected properly.	19
This unit cannot be turned off or does not work properly.	The internal microcomputer is hung-up due to an external electric shock (such as lightning or excessive static electricity) or by a drop in power supply voltage.	Disconnect the power cable from the AC wall outlet, wait about 30 seconds and then plug it in again.	—
	The batteries in the remote control may have lost their charge.	Replace all batteries.	7
The unit enters standby mode.	The protection circuitry has been activated because of a short circuit, etc.	Check that the speaker with an impedance of at least 6 Ω.	—
		Check that the speaker impedance settings are correct.	18
		Check that the speaker wires are not touching each other, then turn the unit back on.	—
	The sleep timer has turned off the unit.	Turn on the unit, and play the source again.	—

Problem	Cause	Remedy	See page
After display of a countdown on the front panel, the unit goes into standby mode.	If you do not use take any action, the Auto Power Down function operates.	Turn on the unit, and play the source again.	—
		In the Setup menu “Auto Power Down” (“Function” → “Auto Power Down”), increase the time until switching to standby mode, or turn off the Auto Power Down function.	89
No sound.	Incorrect input or output cable connections.	Connect the cables properly. If the problem persists, the cables may be defective.	24
	Speaker connections are not secure.	Secure the connections.	19
	The HDMI components connected to the unit do not support the HDCP copy protection standards.	Connect HDMI components that support the HDCP copy protection standards.	—
	The audio input into the device is set to playback through the TV.	In the Setup menu, set the “Amp” of “Audio Output” (“HDMI” → “Audio Output” → “Amp”) to “On.”	87
	No appropriate input source has been selected.	Select an appropriate input source with Input selector .	40
	The volume is turned down or muted.	Turn up the volume.	—
	Signals that this unit cannot reproduce are being input from a source component, such as a CD-ROM.	Use an input source that has signals that can be reproduced on this unit.	—



Problem	Cause	Remedy	See page
No picture.	The video signal output from this unit is not supported by a monitor connected to this unit via the HDMI OUT 1-2 jacks.	Displays the Advanced Setup menu and select "VIDEO" in "INIT" to reset the video parameters.	98
		Displays the Advanced Setup menu and set "MON.CHK" to "YES."	97
	An appropriate video input is not selected on the TV.	Select an appropriate video input on the TV.	—
No sound is output from a specific speaker.	The speaker is malfunctioning. Check the Speaker indicators on the front panel display. If the corresponding indicator lights up, connect another speaker and check if sound is output.	If sound is not output, the unit may be malfunctioning.	10
		The playback component or speakers are not connected properly.	Connect the cables properly. If the problem persists, the cables may be defective.
	Output from that speaker is disabled.	Check the Speaker indicators on the front panel display. If the corresponding indicator is turned off, try the following. 1) Change to a different input source. 2) With the selected sound program, sound is not output from that speaker. Select another sound program. 3) "None" may have been selected for that speaker on this unit. Display "Speaker" in the Setup menu, and set respective parameters to enable output from that speaker ("Speaker" → "Manual Setup" → "Configuration").	10, 79
	The volume of that speaker is set to the minimum in "Speaker" in the Setup menu.	Display "Speaker" in the Setup menu and adjust the volume ("Speaker" → "Manual Setup" → "Level").	81
	(If hardly any sound comes from one channel) Speaker output balance is not set correctly.	Balance the volume of each speaker from "Level" in the Setup menu ("Speaker" → "Manual Setup" → "Level").	81
	Sound may not be output from certain channels, depending on the input source or sound program.	Try another sound program.	42

Problem	Cause	Remedy	See page
Only the center speaker outputs substantial sound.	When a monaural source sound program is applied, for some surround decoders, sound from all channels is output from the center speaker.	Try another sound program.	42
No sound is heard from the presence speakers.	This unit is in straight decoding mode and a monaural source is being played back.	Press STRAIGHT to exit straight decoding mode.	43
	Sound may not be output from certain channels depending on input sources or sound programs.	Try another sound program.	42
No sound is heard from the surround speakers.	This unit is in straight decoding mode and a monaural source is being played back.	Press STRAIGHT to exit straight decoding mode.	43
	Sound may not be output from certain channels depending on input sources or sound programs.	Try another sound program.	42
No sound is heard from the surround back speakers.	"Extended Surround" in the OPTION menu is set to "OFF," or an input signal does not contain a surround back flag with "Extended Surround" set to "Auto."	Set "Extended Surround" other than "OFF" or "Auto."	52
No sound is heard from the subwoofer.	A subwoofer is not connected, or it is inactive.	Check that a subwoofer is connected correctly, and from the Setup menu "Subwoofer" ("Speaker" → "Manual Setup" → "Configuration" → "Subwoofer"), set the subwoofer to "Use."	19, 81
	The subwoofer is turned off.	Turn the subwoofer power on. If the subwoofer includes an Auto Power Off function, then lower the Auto Power Off sensitivity settings.	—
	The source does not contain LFE (esp. p. 112) or low frequency signals.		—
The right combination of audio / video jacks to connect cannot be found.	Combine input connected to the external component video output with another input audio jack.	Display the Input menu for the connected video output, select "Audio In" and select the jack to use for audio input.	68



Problem	Cause	Remedy	See page
The audio input sources cannot be played in the desired digital audio signal format.	The connected component is not set to output the desired digital audio signals.	Set the playback component properly referring to its instruction manual.	—
There is noise interference from digital or radio frequency equipment.	This unit is too close to other digital or radio frequency equipment.	Move this unit further away from such equipment.	—
Noise/hum noise is heard.	Incorrect cable connection. Connect the audio cables properly.	If the problem persists, the cables may be defective.	—
	A DTS-CD is being played back.	1) When only noise is output If a DTS bitstream signal is not properly input to this unit, only noise is output. Connect the playback component to this unit by digital connection and playback the DTS-CD. If the condition is not improved, the problem may result from the playback component. Consult the manufacturer of the playback component. 2) When noise is output during playback or skip operation Before playing back the DTS-CD, display the Input menu after selecting the input source and set "Decoder Mode" to "DTS."	—
The volume cannot be increased, or the sound is distorted.	The component connected to the output jacks of this unit is not turned on.	When the component connected to the output jacks of this unit is not turned on, the sound may be distorted, or the volume may be decreased due to the nature of AV receivers. Turn on all components connected to this unit.	—
	"Max Volume" is set to a low value.	Set it to a higher value.	83



HDMI™

Problem	Cause	Remedy	See page
The front panel display HDMI indicator is flashing.	An error with the HDMI connection has occurred.	Try re-inserting the HDMI cable.	—
		Confirm that HDMI video that is not supported by the unit is not being input (Information menu → "Video information").	92
No picture or sound.	The number of components is over the limit.	Disconnect some of the HDMI components.	—
	The connected HDMI component does not support high-bandwidth digital copyright protection (HDCP).	Connect an HDMI component that supports HDCP.	—
(When using HDMI Control function) TV sound is not output from this unit when operating the remote control of the TV.	The TV audio output is not connected to this unit, or the setting to match operations carried out on TV is not set.	Connect the TV audio output to this unit, and then select the connected input source in "TV Audio Input" (Setup menu → HDMI → TV Audio Input).	86
	(When using Audio Return Channel function) The Audio Return Channel function is not working.	Make sure that your TV supports Audio Return Channel. Set the Audio Return Channel function to on (Setup menu → HDMI → ARC (Audio Return Channel)).	86



Tuner (FM/AM)

FM

Problem	Cause	Remedy	See page
FM stereo reception is noisy.	You are too far from the station transmitter, or the input from the antenna is weak.	Check the antenna connections.	31
		Switch to monaural mode.	57
		Replace the outdoor antenna with a more sensitive multi-element antenna.	—
There is distortion, and clear reception cannot be obtained even with a good FM antenna.	There is multi-path interference.	Adjust the antenna height or orientation, or place it in a different location.	—
The desired station cannot be tuned into with the automatic tuning method.	You are in an area far from a station, or input from the antenna is weak.	Replace the outdoor antenna with a more sensitive multi element antenna.	—
		Use TUNING   to manually select the station.	55
“No Presets” is displayed.	No preset stations are registered.	Register stations you want to listen to as preset stations before operation.	56
“Wrong Station” is displayed.	An invalid FM/AM frequency has been input.	Input a frequency that can be received.	—

AM

Problem	Cause	Remedy	See page
The desired station cannot be tuned into with the automatic tuning method.	The signal is weak, or the antenna connections are loose.	Adjust the AM loop antenna orientation.	31
		Use the manual tuning method.	55
Automatic station preset does not work.	Automatic station preset is not available for AM stations.	Use manual station preset.	55
Continuous crackling and hissing noises are heard.	The supplied AM loop antenna is not connected.	Connect the AM loop antenna correctly even if you use an outdoor antenna.	31
	The noises may be caused by lightning, fluorescent lamps, motors, thermostats, or other electrical equipment.	It is difficult to completely eliminate noise, but it can be reduced by installing and properly grounding an outdoor AM antenna.	31
Buzzing and whining noises are heard.	A TV set is being used nearby.	Move this unit away from the TV set.	—



iPod™/iPhone™

Display	Cause	Remedy	See page
Loading...	The unit is in the process of recognizing the connection with your iPod/iPhone.		—
	The unit is in the middle of acquiring song lists from your iPod/iPhone.		—
Connect error	There is a problem with the signal path from your iPod/iPhone to the unit.	Turn off the unit and reconnect the Universal Dock for iPod/iPhone to the DOCK jack of the unit.	59
		Remove your iPod/iPhone from the Universal Dock for iPod/iPhone and then place it back in the dock.	59
Unknown iPod	The iPod/iPhone being used is not supported by the unit.	Connect an iPod/iPhone supported by the unit.	—
iPod connected	Your iPod/iPhone is properly placed in the Universal Dock for iPod/iPhone.		—
	Your iPod/iPhone is properly placed in the Yamaha iPod wireless transmitter and connected with this unit via wireless transmission.		62
Disconnected	Your iPod/iPhone is removed from the Universal Dock for iPod/iPhone.		—
	Your iPod/iPhone is disconnected with this unit via wireless transmission.		—
Unable to play	The unit cannot playback the songs currently stored on your iPod/iPhone.	Check that songs are currently stored on your iPod/iPhone.	—

Bluetooth™

Display	Cause	Remedy	See page
Searching...	The Yamaha Bluetooth wireless audio receiver and the Bluetooth component are in the process of pairing.		—
	The Yamaha Bluetooth wireless audio receiver and the Bluetooth component are in the process of establishing a connection.		—
Completed	The pairing is completed.		—
Canceled	The pairing is canceled.		—
BT connected	The connection between the Yamaha Bluetooth wireless audio receiver and the Bluetooth component is established.		—
Disconnected	The Bluetooth component is disconnected from the Yamaha Bluetooth wireless audio receiver.		—
Not found	The Bluetooth component is not found.	During pairing: – pairing must be performed on the Bluetooth component and this unit simultaneously. Check if the Bluetooth component is in pairing mode.	—
		During connecting: – check if the Bluetooth component is turned on. – check if the Bluetooth component is within 10 m of the Yamaha Bluetooth wireless audio receiver.	
	Pairing may not have been achieved.	Try pairing again.	64



Remote control

Problem	Cause	Remedy	See page
The remote control does not work or function properly.	Wrong distance or angle.	The remote control will function within a maximum range of 6 m, and no more than 30 degrees off-axis from the front panel.	—
	Direct sunlight or lighting (from an inverter type of fluorescent lamp, strobe light, etc.) is striking the remote control sensor of this unit.	Adjust the lighting angle, or reposition this unit.	—
	The batteries are weak.	Replace all batteries.	7
	The remote control ID of the remote control and this unit do not match.	Match the remote control ID of this unit and the remote control.	94
External components cannot be controlled using the remote control.	The remote control code is not correctly set.	Set the remote control code correctly using " Remote control code search " on the CD-ROM.	—
		Try setting another code for the same manufacturer using " Remote control code search " on the CD-ROM.	—
		If this unit does not work when you press Cursor $\Delta / \nabla / \triangleleft / \triangleright$, do the following. When the key does not work during DVD disc menu operation: press the Input selector again. When there is no response with remote control operation of the OPTION menu/ Setup menu: press SOURCE/RECEIVER (it should glow orange) and try operating the remote control again.	—
Even if the remote control code is correctly set, there are some models that do not respond to the remote control.			—



Glossary

Audio information

Audio and video synchronization (Lipsync)

Lip sync, an abbreviation for lip synchronization, is a technical term that involves both a problem, and the capability of maintaining audio and video signals synchronized during post-production and transmission.

Whereas the audio and video latency requires complex end-user adjustment, HDMI version 1.3 incorporates an automatic audio and video syncing capability that allows devices to perform this synchronization automatically and accurately without user interaction.

Bi-amplification connection (Bi-amp)

A bi-amplification connection uses two amplifiers for a speaker. One amplifier is connected to the woofer section of a loudspeaker while the other is connected to the combined mid and tweeter section. With this arrangement each amplifier operates over a restricted frequency range. This restricted range presents each amplifier with a much simpler job and each amplifier is less likely to influence the sound in some way.

Dolby Digital

Dolby Digital is a digital surround sound system that gives you completely independent multi-channel audio. With 3 front channels (front L/R and center), and 2 surround stereo channels, Dolby Digital provides 5 full-range audio channels. With an additional channel especially for bass effects, referred to as LFE (Low-Frequency Effect), the system has a total of 5.1-channels (LFE is counted as 0.1 channel). By using 2-channel stereo for the surround speakers, more accurate moving sound effects and surround sound environments are possible than with Dolby Surround. The wide dynamic range from maximum to minimum volumes that are reproduced by the 5 full-range channels, and the precise sound orientation generated using digital sound processing provides listeners with unprecedented excitement and realism. With this unit, any sound environment from monaural up to a 5.1-channel configuration can be freely selected for your enjoyment.

Dolby Pro Logic II

Dolby Pro Logic II is an improved technique used to decode vast numbers of existing Dolby Surround sources. This new technology enables a discrete 5-channel playback with 2 front left and right channels, 1 center channel, and 2 surround left and right channels, instead of only 1 surround channel for conventional Pro Logic technology. There are three modes available: “Music mode” for music sources, “Movie mode” for movie sources, and “Game mode” for game sources.

Dolby Pro Logic IIx

Dolby Pro Logic IIx is a new technology enabling discrete multichannel playback from 2-channel or multi-channel sources. There are three modes available: “Music mode” for music sources, “Movie mode” for movie sources (for 2-channel sources only) and “Game mode” for game sources.

Dolby Surround

Dolby Surround uses a 4-channel analog recording system to reproduce realistic and dynamic sound effects: 2 front left and right channels (stereo), a center channel for dialog (monaural), and a surround channel for special sound effects (monaural). The surround channel reproduces sound within a narrow frequency range. Dolby Surround is widely used with nearly all video tapes and laser discs, as well as in many TV and cable broadcasts. The Dolby Pro Logic decoder built into this unit employs a digital signal processing system that automatically stabilizes the volume on each channel to enhance moving sound effects and directionality.

Dolby TrueHD

Dolby TrueHD is an advanced lossless audio technology developed for high-definition disc-based media including Blu-ray Disc. Selected as an optional audio standard for Blu-ray Disc, this technology delivers sound that is bit-for-bit identical to the studio master, offering a high-definition home theater experience. Supporting bitrates up to 18.0 Mbps, Dolby TrueHD can carry up to 8 discrete channels of 24-bit/96 kHz audio simultaneously. Dolby TrueHD also remains fully compatible with the existing multichannel audio systems and retains the metadata capability of Dolby Digital, allowing dialog normalization and dynamic range control.

DTS 96/24

DTS 96/24 offers an unprecedented level of audio quality for multichannel sound on DVD video, and is fully backward-compatible with all DTS decoders. “96” refers to a 96 kHz sampling rate compared to the typical 48 kHz sampling rate. “24” refers to 24-bit word length. DTS 96/24 offers sound quality transparent to the original 96/24 master, and 96/24 5.1-channel sound with full-quality full-motion video for music programs and motion picture soundtracks on DVD video.

DTS Digital Surround

DTS Digital Surround was developed to replace the analog soundtracks of movies with a 5.1-channel digital sound track, and is now rapidly gaining popularity in movie theaters around the world. DTS, Inc. has developed a home theater system so that you can enjoy the depth of sound and natural spatial representation of DTS Digital Surround in your home. This system produces practically distortion-free 5.1-channel sound (technically, left, right and center channels, 2 surround channels, plus an LFE 0.1 channel as a subwoofer, for a total of 5.1-channels). This unit incorporates a DTS-ES decoder that enables 6.1-channel reproduction by adding the surround back channel to the existing 5.1-channel format.

DTS Express

This is an audio format for next-generation optical discs such as Blu-ray discs. It uses optimized low bit rate signals for network streaming. In the case of a Blu-ray disc, this format is used with secondary audio, enabling you to enjoy the commentary of the movie producer via the Internet while playing the main program.

DTS-HD High Resolution Audio

DTS-HD High Resolution Audio is a high resolution audio technology developed for high-definition disc-based media including Blu-ray Disc. Selected as an optional audio standard for Blu-ray Disc, this technology delivers sound that is virtually indistinguishable from the original, offering a high-definition home theater experience.

Supporting bitrates up to 6.0 Mbps for Blu-ray Disc, DTS-HD High Resolution Audio can carry up to 7.1 discrete channels of 24-bit/96 kHz audio simultaneously.

DTS-HD High Resolution Audio also remains fully compatible with the existing multichannel audio systems that incorporate DTS Digital Surround.

DTS-HD Master Audio

DTS-HD Master Audio is an advanced lossless audio technology developed for high-definition disc-based media including Blu-ray Disc. Selected as an optional audio standard for Blu-ray Disc, this technology delivers sound that is bit-for-bit identical to the studio master, offering a high-definition home theater experience.

Supporting bitrates up to 24.5 Mbps for Blu-ray Disc, DTS-HD Master Audio can carry up to 7.1 discrete channels of 24-bit/96 kHz audio simultaneously. Supported by HDMI version 1.3 and designed for the optical disc players and AV receivers/amplifiers of the future, DTS-HD Master Audio also remains fully compatible with the existing multichannel audio systems that incorporate DTS Digital Surround.



DSD

Direct Stream Digital (DSD) technology stores audio signals on digital storage media, such as Super Audio CDs. Using DSD, signals are stored as single bit values at a high-frequency sampling rate of 2.8224 MHz, while noise shaping and oversampling are used to reduce distortion, a common occurrence with very high quantization of audio signals. Due to the high sampling rate, better audio quality can be achieved than that offered by the PCM format used for normal audio CDs. The frequency is equal to or higher than 100 kHz, with a dynamic range of 120 dB. This unit can transmit or receive DSD signals via the HDMI jack.

LFE 0.1 channel

This channel reproduces low-frequency bass signals, and has a frequency range from 20 Hz to 120 Hz. This channel is counted as 0.1, because it only enforces a low-frequency range compared to the full-range reproduced by the other 5-channels in Dolby Digital or DTS 5.1-channel systems.

Neo:6

Neo:6 decodes the conventional 2-channel sources for 6-channel playback by the specific decoder. It enables playback with the full-range channels with higher separation just like digital discrete signal playback. There are two modes available: “Music mode” for music sources and “Cinema mode” for movie sources.

PCM (Linear PCM)

Linear PCM is a signal format under which an analog audio signal is digitized, recorded and transmitted without using any compression. This is used as a method of recording CDs and DVD audio. The PCM system uses a technique for sampling the size of the analog signal per very small unit of time. Standing for “Pulse Code Modulation,” the analog signal is encoded as pulses and then modulated for recording.

Sampling frequency and number of quantized bits

When digitizing an analog audio signal, the number of times the signal is sampled per second is called the sampling frequency, while the degree of accuracy when converting the sound level into a numeric value is called the number of quantized bits. The range of rates that can be played back is determined based on the sampling rate, whereas the dynamic range representing the sound level difference is determined by the number of quantized bits. In principle, the higher the sampling frequency, the wider the range of frequencies that can be played back, and the higher the number of quantized bits, the more accurately the sound level can be reproduced.

Sound program information**CINEMA DSP**

Since the Dolby Surround and DTS systems were originally designed for use in movie theaters, their effect is best felt in a theater having many speakers designed for acoustic effects. Since home conditions, such as room size, wall material, number of speakers, and so on, can differ so widely, it is inevitable that there are differences in the sound that is heard. Based on a wealth of actually measured data, Yamaha CINEMA DSP uses Yamaha’s original DSP technology to combine Dolby Pro Logic, Dolby Digital, and DTS systems to provide the audiovisual experience of a movie theater in the listening room of your own home.

Compressed Music Enhancer

The Compressed Music Enhancer feature of this unit enhances your listening experience by regenerating the missing harmonics in compression artifacts. As a result, it compensates for flattened complexity due to the loss of high-frequency fidelity as well as lack of bass due to the loss of low-frequency bass, providing improved performance for the overall sound system.

SILENT CINEMA

Yamaha has developed a natural, realistic sound effect DSP algorithm for headphones. Parameters for headphones have been set for each sound program, so that accurate representations of all the sound programs can be enjoyed on headphones.

Virtual CINEMA DSP

Yamaha has developed a Virtual CINEMA DSP algorithm that allows you to enjoy DSP surround effects even without any surround speakers, by using virtual surround speakers. It is even possible to enjoy Virtual CINEMA DSP using a minimal two-speaker system that does not include a center speaker.

CINEMA DSP 3D

The actually measured sound field data contain the information of the height of the sound images. CINEMA DSP 3D feature achieves the reproduction of the accurate height of the sound images so that it creates the accurate and intensive stereoscopic sound fields in a listening room.

Video information**Component video signal**

With the component video signal system, the video signal is separated into the Y signal for luminance and the PB and PR signals for chrominance. Color can be reproduced more faithfully with this system because each of these signals is independent. The component signal is also called the “color difference signal” because the luminance signal is subtracted from the color signal. A monitor with component input jacks is required in order to output component signals.

Composite video signal

With the composite video signal system, the video signal comprises the three basic elements of a video picture: color, brightness and synchronization data. A composite video jack on a video component transmits these three elements combined.

Deep Color

Deep Color refers to the use of various color depths in displays, up from the 24-bit depths in previous versions of the HDMI specification. This extra bit depth allows HDTVs and other displays increase from millions of colors to billions of colors and eliminate on-screen color banding for smooth tonal transitions and subtle gradations between colors. The increased contrast ratio can represent many times more shades of gray between black and white. Additionally, Deep Color increases the number of available colors within the boundaries defined by the RGB or YCbCr color space.

HDMI

HDMI (High-Definition Multimedia Interface) is the first industry supported, uncompressed, all-digital audio/video interface. Providing an interface between any sources (such as set-top boxes or AV receivers) and audio/video monitors (such as digital televisions), HDMI supports standard, enhanced or high-definition video as well as multichannel digital audio using a single cable. HDMI transmits all ATSC HDTV standards and supports 8-channel digital audio, with bandwidth to spare to accommodate future enhancements and requirements.

When used in combination with HDCP (High-bandwidth Digital Content Protection), HDMI provides a secure audio/video interface that meets the security requirements of content providers and system operators. For further information on HDMI, visit the HDMI website at “<http://www.hdmi.org/>.”



“x.v.Color”

A color space standard supported by HDMI version 1.3. It is a more extensive color space than sRGB, and allows the expression of colors that were not hitherto possible. While remaining compatible with the color gamut of sRGB standards, “x.v.Color” expands the color space, and can thus produce more vivid, natural images. It is particularly effective for still pictures and computer graphics.

Video conversion

Analog-to-HDMI video conversion is performed according to resolution of video signals as shown below. Analog-to-analog video conversion is also possible when “Analog to Analog Conversion” is set to “On” ([p. 84](#)).

✓: available conversion

	Resolution	HDMI output					COMPONENT VIDEO output					VIDEO output
		480i/576i	480p/576p	720p	1080i	1080p	480i/576i	480p/576p	720p	1080i	1080p	480i/576i
HDMI input	480i/576i	✓	✓	✓	✓	✓						
	480p/576p		✓	✓	✓	✓						
	720p			✓								
	1080i				✓							
	1080p					✓						
COMPONENT VIDEO input	480i/576i	✓	✓	✓	✓	✓	✓					✓
	480p/576p		✓	✓	✓	✓		✓				
	720p			✓					✓			
	1080i				✓					✓		
VIDEO input	480i/576i	✓	✓	✓	✓	✓	✓					✓



Information on HDMI™

■ HDMI signal compatibility

Audio signals

Audio signal types	Audio signal formats	Compatible media
2ch Linear PCM	2ch, 32-192 kHz, 16/20/24 bit	CD, DVD-Video, DVD-Audio, etc.
Multi-ch Linear PCM	8ch, 32-192 kHz, 16/20/24 bit	DVD-Audio, Blu-ray Disc, HD DVD, etc.
DSD	2/5.1ch, 2.8224 MHz, 1 bit	SACD, etc.
Bitstream	Dolby Digital, DTS	DVD-Video, etc.
Bitstream (High definition audio)	Dolby TrueHD, Dolby Digital Plus, DTS-HD Master Audio, DTS-HD High Resolution Audio, DTS Express	Blu-ray Disc, HD DVD, etc.

- If the input source component can decode the bitstream audio signals of audio commentaries, you can playback the audio sources with the audio commentaries mixed down by using the digital audio input (optical or coaxial) connections.
- Refer to the supplied instruction manuals of the input source component, and set the component appropriately.

NOTES

- When CPPM copy-protected DVD-Audio is played back, video and audio signals may not be output, depending on the type of the DVD player.
- This unit is not compatible with HDCP-incompatible HDMI or DVI components.
- Refer to the supplied instruction manuals for details.
To decode audio bitstream signals on this unit, set the input source component appropriately so that the component outputs the bitstream audio signals directly (does not decode the bitstream signals on the component).
- This unit is not compatible with the audio commentary features (for example, the special audio contents downloaded via Internet) of Blu-ray Disc or HD DVD. This unit does not playback the audio commentaries of the Blu-ray Disc or HD DVD content.

Video signals

This unit is compatible with the video signals of the following resolutions:

- 480i/60 Hz
- 576i/50 Hz
- 480p/60 Hz
- 576p/50 Hz
- 720p/60 Hz, 50 Hz
- 1080i/60 Hz, 50 Hz
- 1080p/60 Hz, 50 Hz, 24 Hz

About trademarks



Manufactured under license from Dolby Laboratories. Dolby, Pro Logic and the double-D symbol are trademarks of Dolby Laboratories.



Manufactured under license under U.S. Patent No's: 5,451,942;5,956,674;5,974,380;5,978,762;6,226,616;6,487,535 & other U.S. and worldwide patents issued & pending. DTS is a registered trademark and the DTS logos, Symbol, DTS-HD and DTS-HD Master Audio are trademark of DTS, Inc. © 1996-2007 DTS, Inc. All Rights Reserved.

iPod™, iPhone™

“iPod” is a trademark of Apple Inc., registered in the U.S. and other countries. “iPhone” is a trademark of Apple Inc.

Bluetooth™

Bluetooth is a registered trademark of the Bluetooth SIG and is used by Yamaha in accordance with a license agreement.



“HDMI,” the “HDMI” logo and “High-Definition Multimedia Interface” are trademarks, or registered trademarks of HDMI Licensing LLC.

SILENT™
CINEMA

“SILENT CINEMA” is a trademark of Yamaha Corporation.

Specifications

■ Input jacks

- Analog audio
 - Audio x 6 (PHONO, AV5, AV6, AUDIO1, AUDIO2, V-AUX)
 - MULTI CH INPUT x 1 (8ch Input)
- Digital audio
 - Optical x 2 (AV1, AV4)
 - Coaxial x 2 (AV2, AV3)
- Video
 - Composite x 5 (AV3, AV4, AV5, AV6, V-AUX)
 - S-Video x 1 (AV5) [U.K. and Europe models]
 - Component x 2 (AV1, AV2)
- HDMI input
 - HDMI (Front Panel) x 1 (V-AUX)
 - HDMI (Rear Panel) x 5 (HDMI 1-5)
- Other
 - DOCK x 1 (AUDIO, VIDEO [Composite])

■ Output jacks

- Analog Audio
 - Speaker out x 9 (7 ch) (FRONT L/R, CENTER, SURROUND L/R, SURROUND BACK L/R^{*1}, EXTRA SP L/R^{*2})
- *1 Note: assignment is possible. [SURROUND BACK, BI-AMP (FRONT L/R)]
- *2 Note: assignment is possible. [ZONE2, PRESENCE]
- Pre Out x 7 [FRONT L/R, CENTER, SURROUND L/R, SURROUND BACK L/R]
- Subwoofer out x 2 (MONO, SUBWOOFER)
- AV OUT x 1
- AUDIO OUT x 1
- ZONE2 OUT x 1
- Video
 - MONITOR OUT
 - Component x 1
 - Composite x 1
 - AV OUT
 - Composite x 1
- HDMI Output
 - HDMI OUT x 2 (HDMI OUT 1-2)

■ Remote jacks

- REMOTE IN x 1
- REMOTE OUT x 1
- TRIGGER OUT x 1

■ HDMI

- HDMI Specification: Deep Color, “x.v.Color,” Auto Lips Sync, ARC (Audio Return Channel), 3D
- Video Format (Repeater Mode)
 - VGA
 - 480i/60 Hz
 - 576i/50 Hz
 - 480p/60 Hz
 - 576p/50 Hz
 - 720p/60 Hz, 50 Hz
 - 1080i/60 Hz, 50 Hz
 - 1080p/60 Hz, 50 Hz, 24 Hz
- Analog up Conversion
 - 480i/60 Hz (NTSC)
 - 576i/50 Hz (PAL)
 - 480p/60 Hz
 - 576p/50 Hz
 - 720p/60 Hz, 50 Hz
 - 1080i/60 Hz, 50 Hz
- Up-Scaling
 - 480i → 480p/720p/1080i/1080p
 - 480p → 720p/1080i/1080p
 - 576i → 576p/720p/1080i/1080p
 - 576p → 720p/1080i/1080p
- Audio Format
 - Dolby Digital
 - DTS
 - DSD 6ch
 - Dolby Digital Plus
 - Dolby TrueHD
 - DTS-HD
 - PCM 2ch-8ch (Max 192 kHz/24 bit)
- Content Protection: HDCP compatible

■ TUNER

- Analog Tuner
 - [U.K. and Europe models]
 - FM/AM with RDS x 1 (TUNER)
 - [Other models]
 - FM/AM x 1 (TUNER)

■ Compatible Decoding Formats

- Decoding Format
 - Dolby TrueHD, Dolby Digital Plus
 - DTS-HD Master Audio, DTS-HD High Resolution, DTS Express
 - Dolby Digital, Dolby Digital EX
 - DTS, DTS 96/24, DTS-ES Matrix 6.1, DTS-ES Discrete 6.1
- Post Decoding Format
 - Dolby Pro Logic
 - Dolby Pro Logic II Music, Dolby Pro Logic II Movie, Dolby Pro Logic II Game
 - Dolby Pro Logic IIx Music, Dolby Pro Logic IIx Movie, Dolby Pro Logic IIx Game
 - DTS Neo:6 Music, DTS Neo:6 Cinema

■ AUDIO SECTION

- Minimum RMS Output Power for Front, Center, Surround (20-20 kHz, 0.08% THD, 8 Ω)

FRONT L/R	95 W+95 W
CENTER	95 W
SURROUND L/R	95 W+95 W
SURROUND BACK L/R	95 W+95 W
- Dynamic Power (IHF)

Front Speakers 8/6/4/2 Ω	130/165/195/240 W
--------------------------------	-------------------
- Input Sensitivity/Input Impedance

PHONO	3.5 mV/47 kΩ
AV5, etc.	200 mV/47 kΩ
MULTI CH IN	200 mV/47 kΩ
- Maximum Input Voltage

PHONO (1 kHz 0.1% THD)	60 mV or more
AV5, etc. (1 kHz 0.5% THD)	2.3 V or more
- Rated Output Voltage/Output Impedance

AUDIO OUT	200 mV/1.2 kΩ
PRE OUT	1.0 V/1.2 kΩ
SUBWOOFER (2ch Stereo & Front: Small)	1.0 V/1.2 kΩ
ZONE2 OUT	200 mV/1.2 kΩ



- Headphone Jack Rated Output/Impedance
AV5, etc. (1 kHz, 50 mV, 8 Ω) 100 mV/560 Ω
- Frequency Response
AV5 to FRONT 10 Hz to 100 kHz, +0/-3 dB
- Total Harmonic Distortion
PHONO (20-20 kHz, 1V) 0.02% or less
AV5, etc. to FRONT (PURE DIRECT)
(20-20 kHz, 50 W, 8 Ω) 0.06% or less
- Signal to Noise Ratio (IHF-A Network)
[Australia, China and General models]
PHONO Input Shorted (5 mV to Front Speakers).....86 dB or more
AV5, etc. (PURE DIRECT). Input Shorted
(250 mV to Front Speakers)..... 100 dB or more
[Other models]
PHONO Input Shorted (5 mV to Front Speakers).....81 dB or more
AV5, etc. (PURE DIRECT). Input Shorted
(250 mV to Front Speakers)..... 100 dB or more
- Residual Noise (IHF-A Network)
Front Speakers 150 μV or less
- Channel Separation (1 kHz/10 kHz)
PHONO Input shorted 60 dB/55 dB or more
AV5, etc. (5.1 kΩ shorted)..... 60 dB/45 dB or more
- Volume Control MUTE / -80 dB to +16.5 dB
- Tone Control (Front Speakers)
Bass Boost/Cut ±6 dB/0.5 dB at 50 Hz
Bass Turnover Frequency 350 Hz
Treble Boost/Cut..... ±6 dB/0.5 dB at 20 kHz
Treble Turnover Frequency 3.5 kHz
- Filter Characteristics (fc=40/60/80/90/100/110/120/160/200 Hz)
H.P.F. (Front, Center, Surround, Surround Back)..... 12 dB/oct.
L.P.F. (Subwoofer)..... 24 dB/oct.

■ VIDEO SECTION

- Video Signal Type
[Korea and General models] NTSC
[Other models] PAL
- Video Conversion.....NTSC/PAL
- Signal Level
Composite 1 Vp-p/75 Ω
S-video
[U.K. and Europe models]..... 1 Vp-p/75 Ω (Y), 0.286 Vp-p/75 Ω (C)
Component 1 Vp-p/75 Ω (Y), 0.7 Vp-p/75 Ω (PB/PR)
- Maximum Input Level (Video Conversion Off) 1.5 Vp-p or more
- Signal to Noise Ratio 50 dB or more
- Frequency Response [MONITOR OUT]
Component (Video Conversion Off) 5 Hz to 60 MHz, -3 dB

■ FM SECTION

- Tuning Range
[Asia and General models]..... 87.5/87.50 to 108.0/108.00 MHz
[Other models] 87.50 to 108.00 MHz
- 50 dB Quieting Sensitivity (IHF)
Mono 3.0 μV (20.8 dB)
- Signal to Noise Ratio (IHF)
Mono/Stereo 74 dB/70 dB
- Harmonic Distortion (1 kHz)
Mono/Stereo 0.3/0.3%
- Antenna Input (unbalanced)..... 75 Ω

■ AM SECTION

- Tuning Range
[Asia and General models]..... 530/531 to 1710/1611 kHz
[Other models] 531 to 1611 kHz

■ GENERAL

- Power Supply
[General model] AC 110/120/220/230-240 V, 50/60 Hz
[China model] AC 220 V, 50 Hz
[Korea model] AC 220 V, 60 Hz
[Australia model] AC 240 V, 50 Hz
[U.K., Europe models]..... AC 230 V, 50 Hz
[Asia model] AC 220/230-240 V, 50/60 Hz
- Power Consumption 400 W
- Standby Power Consumption
HDMI Control off / Standby Through off 0.2 W or less
HDMI Control on/ Standby Through on
(Input: HDMI1, when no HDMI signal is input) ... 2.7 W (typical)
- Dimensions (W x H x D)
435 x 171 x 367.5 mm
- Weight
11.2 kg

* Specifications are subject to change without notice.



Index

Numerics

5 channel speaker layout.....	15
5.1-channel speaker layout.....	15
7.1-channel speaker connection.....	17
7.1-channel speaker layout.....	14

A

Adaptive DRC, OPTION menu.....	52
Advanced Setup menu.....	96
AM antenna connection.....	31
AM tuning.....	55
Analog to Analog Conversion, Video Setup.....	84
ARC (Audio Return Channel), HDMI Setup.....	86
Aspect, Processing, Video Setup.....	85
Audio In, Input menu.....	68
Audio information, Information menu.....	92
AUDIO jack.....	20
Audio Output, HDMI Setup.....	87
Audio Return Channel function.....	101
Auto Power Down, Function Setup.....	89
Auto Preset.....	58
Auto Setup, Speaker Setup.....	79

B

BD player connection.....	24
Bi-amp connection, speaker.....	18
Bluetooth™ component playback.....	64

C

Cable plug.....	20
Center Image, Sound Program menu.....	77
Center Level, Sound Program menu.....	76
Center speaker.....	13
Center Width, Sound Program menu.....	77
Changing speaker impedance.....	18
CINEMA DSP 3D mode.....	44
CINEMA DSP 3D Mode, OPTION menu.....	52
CINEMA DSP indicator.....	10

Clear All Preset.....	58
Clear Preset.....	58
COAXIAL jack.....	20
COMPONENT VIDEO jack.....	20
Compressed Music Enhancer mode.....	45
Configuration, Manual Setup, Speaker Setup.....	80
Connect, OPTION menu.....	53
Connecting speakers.....	17
Connections.....	13
Content browse view.....	54
Content window.....	54
Control Select, HDMI Setup.....	86
Cursor indicators.....	10

D

Decode Type, Sound Program menu.....	76, 77
Decoder Mode, Input menu.....	68
Dialogue Lift, OPTION menu.....	52
Dimension, Sound Program menu.....	77
Direct, Sound Program menu.....	76
Disconnect, OPTION menu.....	53
Display Set, Function Setup.....	89
Distance, Speaker Setup.....	81
DSP Level, Sound Program menu.....	74
DVD player connection.....	24
Dynamic Range, Sound Setup.....	83

E

Enhancer, Input menu.....	68
Extended Surround, OPTION menu.....	52
External component connection.....	20
External decoder connection.....	28

F

FM antenna connection.....	31
FM Mode.....	57
FM tuning.....	55
Front panel.....	8

Front panel display.....	10
Front Presence L Level, Sound Program menu.....	76
Front Presence R Level, Sound Program menu.....	77
Front speaker.....	13
Function Setup.....	88

G

Game connection.....	28
----------------------	----

H

HDMI Control function.....	99
HDMI Control, HDMI Setup.....	86
HDMI indicator.....	10
HDMI jack.....	20
HDMI monitor, Information menu.....	92
HDMI Setup.....	85
High-frequency sound adjustment.....	41

I

Information menu.....	92
INIT, Advanced Setup menu.....	98
Initial Delay, Sound Program menu.....	74
Initial Volume, Sound Setup.....	84
Input menu.....	66
iPhone™ playback.....	59
iPod Interlock, Input menu.....	69
iPod wireless system.....	62
iPod™ playback.....	59

J

Jack.....	20
-----------	----

L

Language.....	91
Level, Speaker Setup.....	81
Lipsync, Sound Setup.....	83
Liveness, Sound Program menu.....	75



Load, SCENE menu	71	Pure Direct mode.....	45	Supplied accessories.....	7
Low-frequency sound adjustment.....	41			Surround Back Initial Delay, Sound Program menu.....	74
M		R		Surround Back L Level, Sound Program menu	76
Manual Preset.....	56	Rear panel.....	9	Surround Back Liveness, Sound Program menu.....	75
Manual Setup, Speaker Setup	79	Remote control.....	11	Surround Back R Level, Sound Program menu	76
Manual Tuning.....	57	Remote control battery installation	7	Surround Back Room Size, Sound Program menu	74
Max Volume, Sound Setup	83	Remote control connection	29	Surround back speaker	13
Memory Guard, Function Setup	91	Remote control, Controlling other components.....	93	Surround Initial Delay, Sound Program menu	74
Menu browse control	60	REMOTE ID, Advanced Setup menu	97	Surround L Level, Sound Program menu.....	76
MON.CHK, Advanced Setup menu.....	97	Rename/Icon Select, Input menu	67	Surround Liveness, Sound Program menu	75
Multi information display	10	Rename/Icon Select, SCENE menu	72	Surround R Level, Sound Program menu	76
Multi Zone	88	Repeat, OPTION menu	53	Surround Room Size, Sound Program menu.....	74
Multi-format player connection	28	Reset, SCENE menu	72	Surround speaker	13
Multi-zone function	103	Resolution, Processing, Video Setup.....	85		
MUTE indicator	10	Reverb Delay, Sound Program menu.....	75	T	
		Reverb Level, Sound Program menu	76	Test Tone, Speaker Setup.....	82
		Reverb Time, Sound Program menu.....	75	Tone control	41
		Room Size, Sound Program menu	74	Tone Control, OPTION menu.....	51
				Trigger connection	30
		S		Trigger Output, Function Setup.....	90
		Save, SCENE menu	71	TU, Advanced Setup menu	98
		SCENE function.....	42	Tuner indicator	10
		SCENE menu	70	TV Audio Input, HDMI Setup	86
		Setup menu.....	78	TV FORMAT, Advanced Setup menu.....	97
		Shuffle, OPTION menu	53	TV monitor connection	21
		SILENT CINEMA mode	44		
		Simple remote control	62	V	
		Sound program	42	VIDEO AUX input cover.....	7
		Sound Program menu.....	73	Video information, Information menu	92
		Sound Setup	83	VIDEO jack	20
		SP IMP., Advanced Setup menu	96	Video Out, Input menu.....	69
		Speaker connection	13	Video Setup.....	84
		Speaker indicators	10	Virtual CINEMA DSP 3D mode.....	44
		Speaker layout.....	14	Virtual CINEMA DSP mode.....	44
		Speaker setting	32	VOLTAGE SELECTOR.....	9
		Speaker Setup.....	79	VOLUME.....	8
		Standby Charge, Input menu.....	68	VOLUME indicator.....	10
		Standby Through, HDMI Setup	87	Volume Trim, OPTION menu.....	53
		Straight Decoding Mode	43		
		Subwoofer	13		



Y

YPAO..... 32

Z

Zone2 Set, Multi Zone 88



